

ANGELA-S

~10° spot beam

SPECIFICATION:

| | |
|----------------|---------|
| Dimensions | Ø 119.5 |
| Height | 74.3 mm |
| Fastening | socket |
| ROHS compliant | yes ⓘ |

MATERIALS:

| Component | Type | Material | Colour | Finish | Coating |
|-----------|-----------|----------|--------|--------|---------|
| ANGELA-S | Reflector | PC | metal | | HMDS |



ORDERING INFORMATION:

| Component | Qty in box | MOQ | MPQ | Box weight (kg) |
|---|------------|-----|-----|-----------------|
| F13379_ANGELA-S » Box size: 398 x 298 x 265 mm | 200 | 100 | 50 | 9.3 |

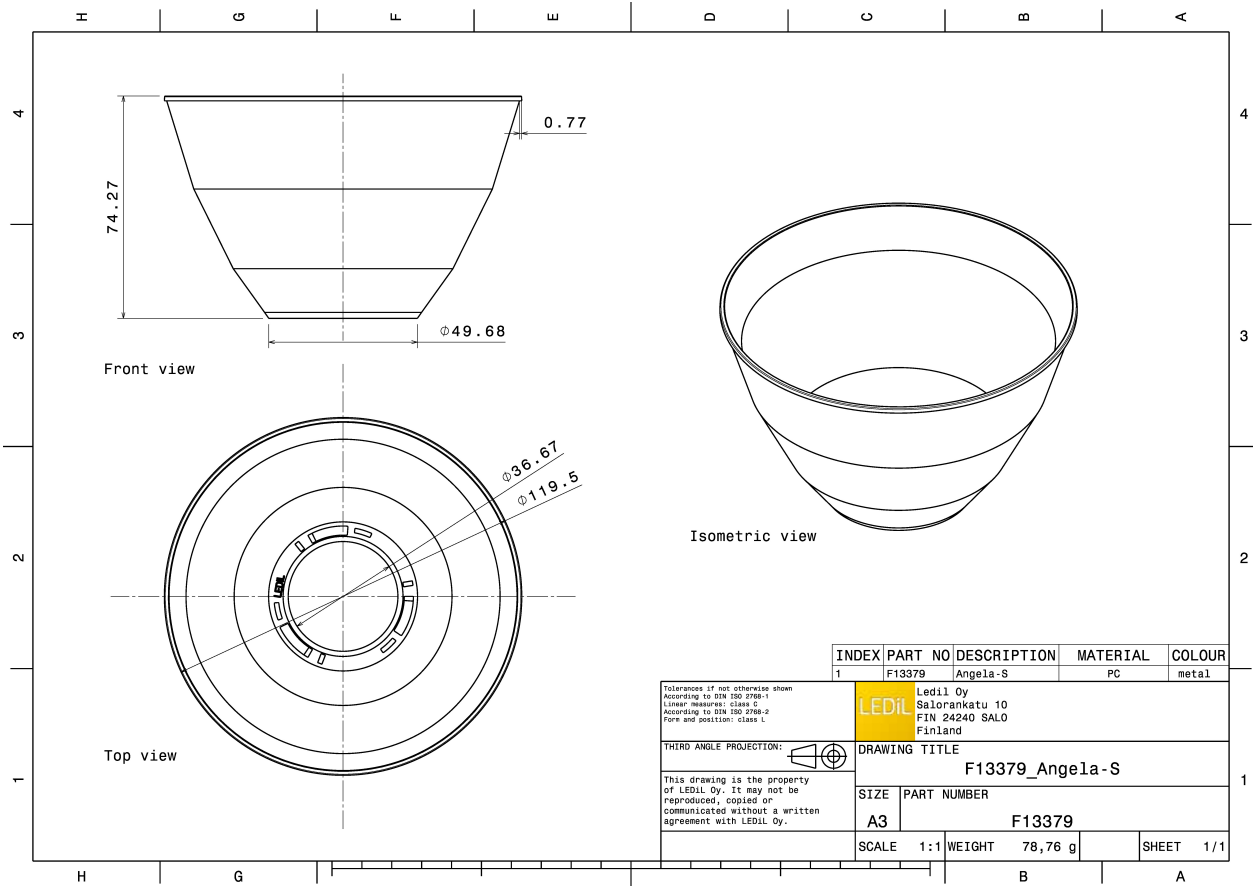

See also our general installation guide: www.ledil.com/installation_guide

OPTICAL RESULTS (MEASURED):

bridgelux

LED V10 Gen7
FWHM / FWTM 8.0° / 17.0°
Efficiency 84 %
Peak intensity 16.2 cd/lm
LEDs/each optic 1
Light colour/type White

Required components:

C13658_CLAMP-VERO13-18

F13671_ANGE-RZ-LENS

Bender Wirth: 434 Typ L1

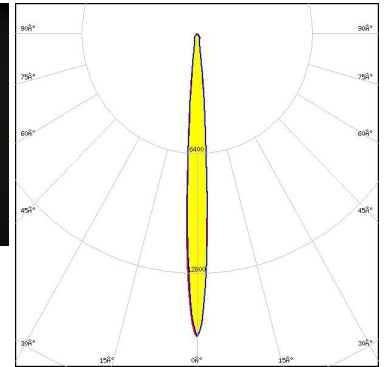

Light distribution files

bridgelux

LED V10 Gen7
FWHM / FWTM 6.0° / 11.0°
Efficiency 89 %
Peak intensity 33.8 cd/lm
LEDs/each optic 1
Light colour/type White

Required components:

C13658_CLAMP-VERO13-18

Bender Wirth: 434 Typ L1

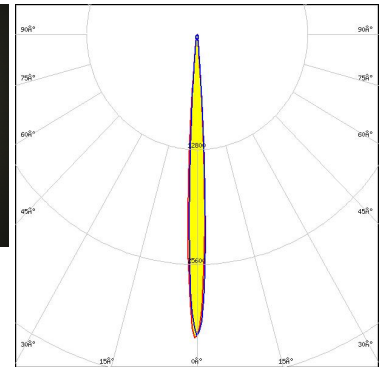

Light distribution files

bridgelux

LED V13 Gen7
FWHM / FWTM 10.0° / 23.0°
Efficiency 86 %
Peak intensity 10.5 cd/lm
LEDs/each optic 1
Light colour/type White

Required components:

F13671_ANGE-RZ-LENS

TE Connectivity: 2213254-2 + OPTIC CLIP Z50 TYPE1 2213194-1

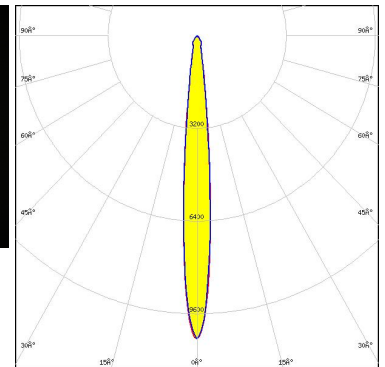

Light distribution files

OPTICAL RESULTS (MEASURED):



LED V13 Gen7
 FWHM / FWTM 9.0° / 17.0°
 Efficiency 90 %
 Peak intensity 17 cd/lm
 LEDs/each optic 1
 Light colour/type White

Required components:

TE Connectivity: 2213254-2 + OPTIC CLIP Z50 TYPE1 2213194-1

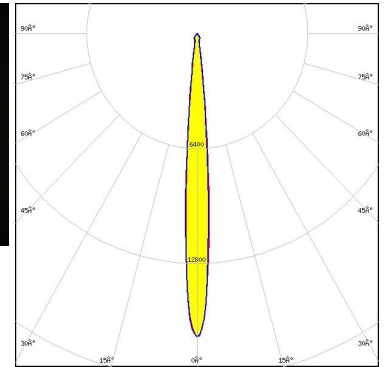
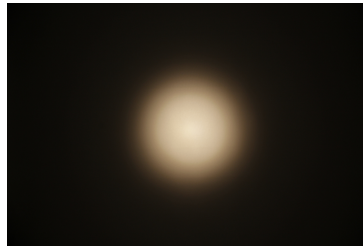

Light distribution files



LED V15 Gen6
 FWHM / FWTM 10.0° / 22.0°
 Efficiency 92 %
 Peak intensity 15.3 cd/lm
 LEDs/each optic 1
 Light colour/type White

Required components:

C13658_CLAMP-VERO13-18

Bender Wirth: 456 Typ L2



Light distribution files



LED Vero SE 13
 FWHM / FWTM 9.0° / 15.0°
 Efficiency 92 %
 Peak intensity 19.9 cd/lm
 LEDs/each optic 1
 Light colour/type White

Required components:

C16402_CLAMP-VEROSE-13-18

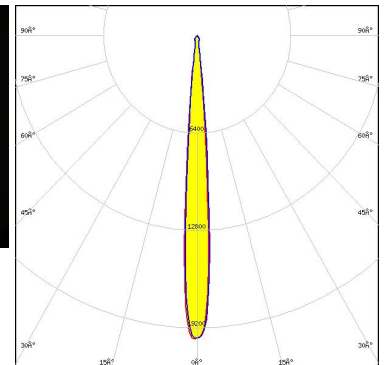
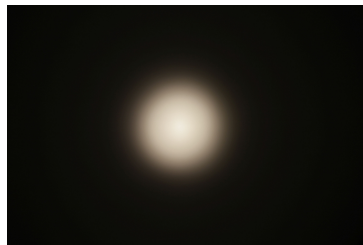

Light distribution files

OPTICAL RESULTS (MEASURED):



LED Vero SE 18
FWHM / FWTM 12.0° / 22.0°
Efficiency 91 %
Peak intensity 10.5 cd/lm
LEDs/each optic 1
Light colour/type White
Required components:
 C16402_CLAMP-VEROSE-13-18

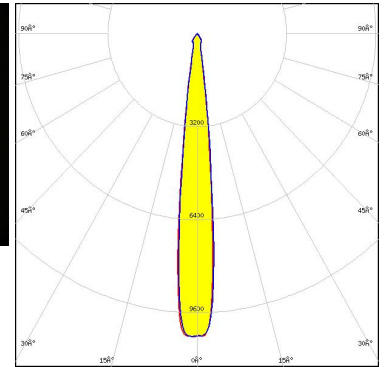

Light distribution files



LED VERO13
FWHM / FWTM 8.0° / 15.0°
Efficiency 94 %
Peak intensity 22.5 cd/lm
LEDs/each optic 1
Light colour/type White
Required components:
 C13658_CLAMP-VERO13-18

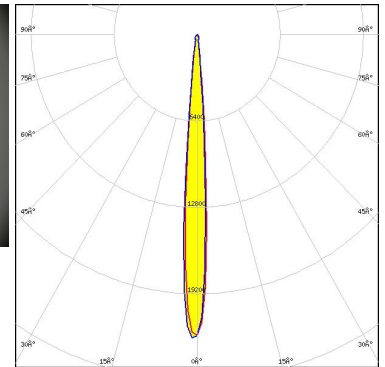

Light distribution files



LED VERO18
FWHM / FWTM 12.0° / 22.0°
Efficiency 93 %
Peak intensity 11 cd/lm
LEDs/each optic 1
Light colour/type White
Required components:
 C13658_CLAMP-VERO13-18

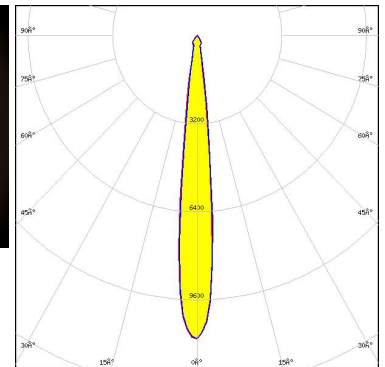
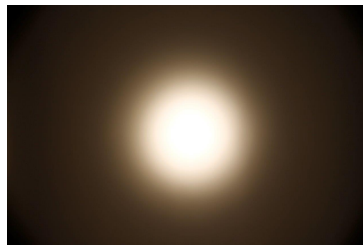

Light distribution files

OPTICAL RESULTS (MEASURED):



LED VERO29
FWHM / FWTM 22.0° / 55.0°
Efficiency 85 %
Peak intensity 3.6 cd/lm
LEDs/each optic 1
Light colour/type White
Required components:
 C13584_CLAMP-VERO29
 F13671_ANGE-RZ-LENS

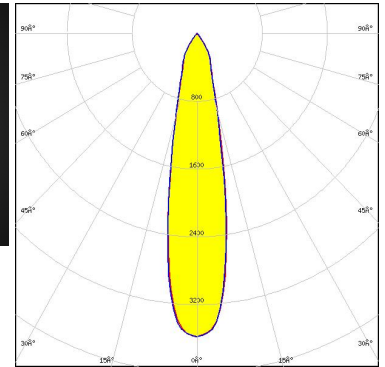
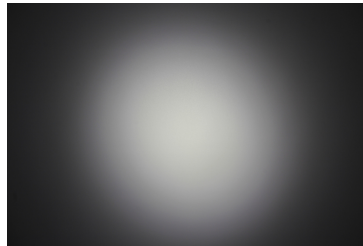

Light distribution files



LED VERO29
FWHM / FWTM 22.0° / 57.0°
Efficiency 85 %
Peak intensity 3.4 cd/lm
LEDs/each optic 1
Light colour/type White
Required components:
 C13584_CLAMP-VERO29
 F13671_ANGE-RZ-LENS

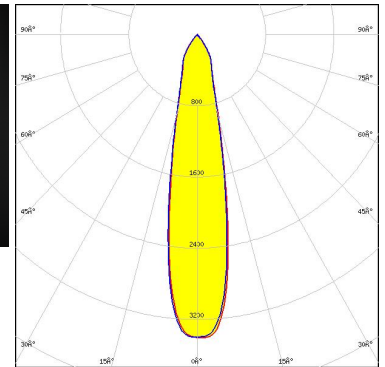
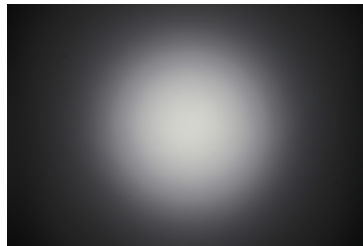

Light distribution files



LED Vesta TW 15mm DP
FWHM / FWTM 11.0° / 24.0°
Efficiency 88 %
Peak intensity 10.8 cd/lm
LEDs/each optic 1
Light colour/type Tunable White
Required components:
 C13658_CLAMP-VERO13-18
 F13671_ANGE-RZ-LENS
 Bender Wirth: 482 Typ L2

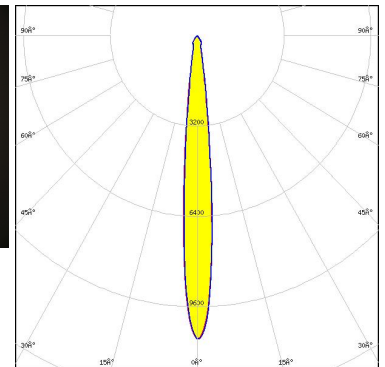

Light distribution files

OPTICAL RESULTS (MEASURED):



LED Vesta TW 15mm DP
FWHM / FWTM 11.0° / 19.0°
Efficiency 92 %
Peak intensity 14 cd/lm
LEDs/each optic 1
Light colour/type Tunable White
Required components:
 C13658_CLAMP-VERO13-18
 Bender Wirth: 482 Typ L2

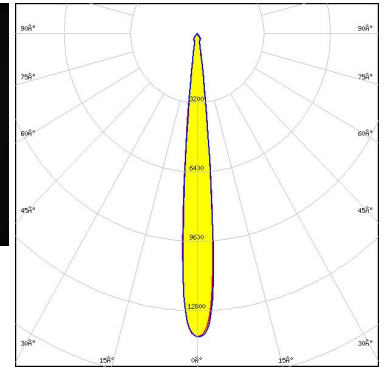

Light distribution files



LED Vesta TW 18mm (31W) DP
FWHM / FWTM 13.0° / 29.0°
Efficiency 87 %
Peak intensity 7.7 cd/lm
LEDs/each optic 1
Light colour/type Tunable White
Required components:
 C13584_CLAMP-VERO29
 F13671_ANGE-RZ-LENS
 Bender Wirth: 483 Typ L3

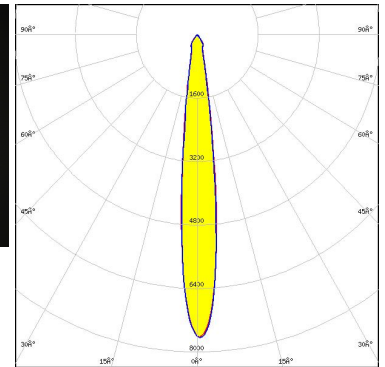

Light distribution files



LED Vesta TW 18mm (31W) DP
FWHM / FWTM 13.0° / 25.0°
Efficiency 92 %
Peak intensity 9.3 cd/lm
LEDs/each optic 1
Light colour/type Tunable White
Required components:
 C13584_CLAMP-VERO29
 Bender Wirth: 483 Typ L3

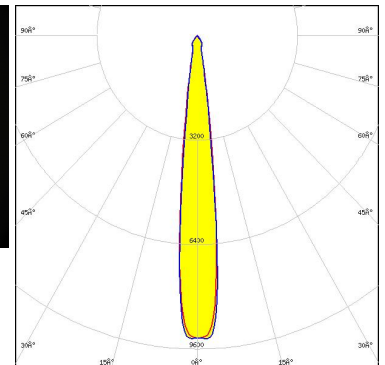

Light distribution files

OPTICAL RESULTS (MEASURED):



LED Vesta TW 22mm DP
FWHM / FWTM 14.0° / 29.0°
Efficiency 92 %
Peak intensity 7.5 cd/lm
LEDs/each optic 1
Light colour/type Tunable White
Required components:
 C13584_CLAMP-VERO29
 Bender Wirth: 494 Typ L3

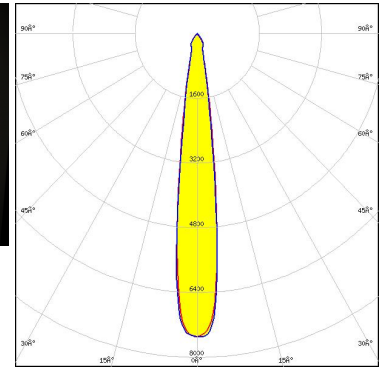

Light distribution files



LED Vesta TW 22mm DP
FWHM / FWTM 15.0° / 35.0°
Efficiency 87 %
Peak intensity 6 cd/lm
LEDs/each optic 1
Light colour/type Tunable White
Required components:
 C13584_CLAMP-VERO29
 F13671_ANGE-RZ-LENS
 Bender Wirth: 494 Typ L3

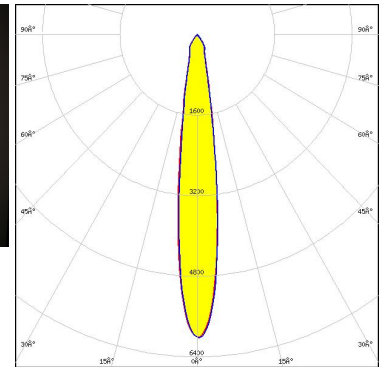

Light distribution files

CITIZEN

LED CLL02x/CLU02x (LES10)
FWHM / FWTM 6.0° / 12.0°
Efficiency 90 %
Peak intensity 34.1 cd/lm
LEDs/each optic 1
Light colour/type White
Required components:
 C13658_CLAMP-VERO13-18
 Bender Wirth: 434 Typ L1

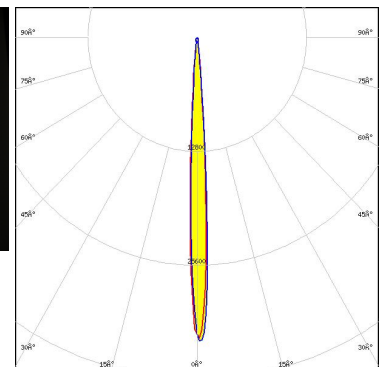

Light distribution files

OPTICAL RESULTS (MEASURED):

CITIZEN

LED CLL03x/CLU03x
 FWHM / FWTM 10.0° / 23.0°
 Efficiency 89 %
 Peak intensity 11.2 cd/lm
 LEDs/each optic 1
 Light colour/type White
 Required components:
 C16791_CLAMP-Z45-A
 F13671_ANGE-RZ-LENS
 TE Connectivity: 2325807-3

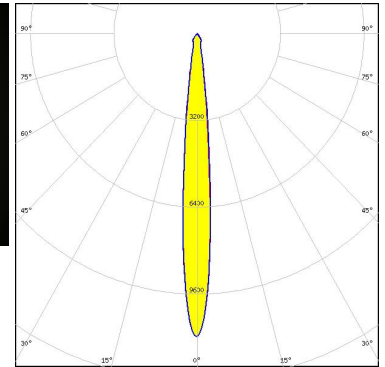

Light distribution files

CITIZEN

LED CLL03x/CLU03x
 FWHM / FWTM 11.0° / 24.0°
 Efficiency 85 %
 Peak intensity 10 cd/lm
 LEDs/each optic 1
 Light colour/type White
 Required components:
 F13671_ANGE-RZ-LENS
 TE Connectivity: 2213254-2 + OPTIC CLIP Z50 TYPE1 2213194-1

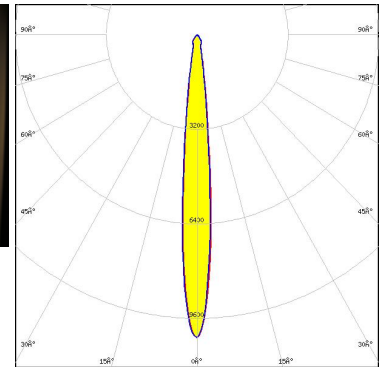

Light distribution files

CITIZEN

LED CLL03x/CLU03x
 FWHM / FWTM 9.0° / 17.0°
 Efficiency 94 %
 Peak intensity 18.6 cd/lm
 LEDs/each optic 1
 Light colour/type White
 Required components:
 TE Connectivity: 2213254-2 + OPTIC CLIP Z50 TYPE1 2213194-1

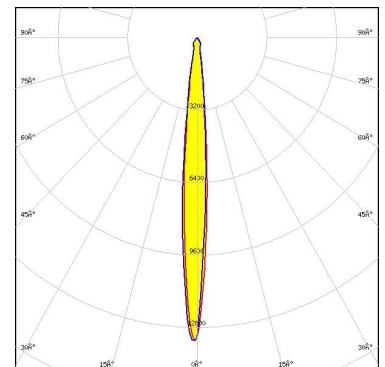

Light distribution files

OPTICAL RESULTS (MEASURED):

CITIZEN

LED CLL03x/CLU03x
FWHM / FWTM 11.0° / 26.0°
Efficiency 84 %
Peak intensity 8.6 cd/lm
LEDs/each optic 1
Light colour/type White
Required components:
F13671_ANGE-RZ-LENS
IDEAL: 50-2103CT + 50-2100AN

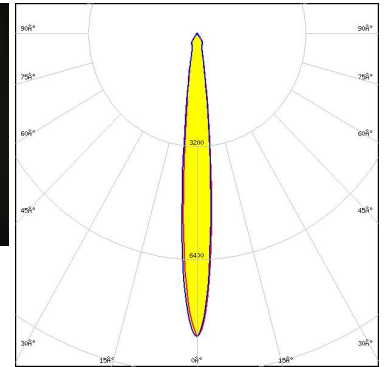

Light distribution files

CITIZEN

LED CLL03x/CLU03x
FWHM / FWTM 9.0° / 20.0°
Efficiency 88 %
Peak intensity 14 cd/lm
LEDs/each optic 1
Light colour/type White
Required components:
IDEAL: 50-2103CT + 50-2100AN

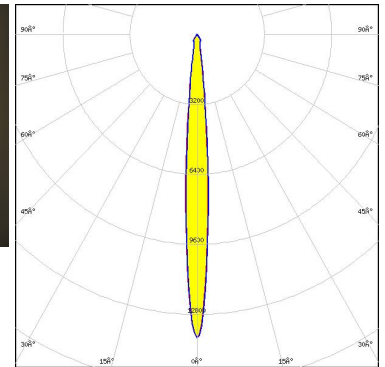

Light distribution files

CITIZEN

LED CLL03x/CLU03x
FWHM / FWTM 9.0° / 18.0°
Efficiency 93 %
Peak intensity 16.6 cd/lm
LEDs/each optic 1
Light colour/type White
Required components:
C16791_CLAMP-Z45-A
TE Connectivity: 2325807-3

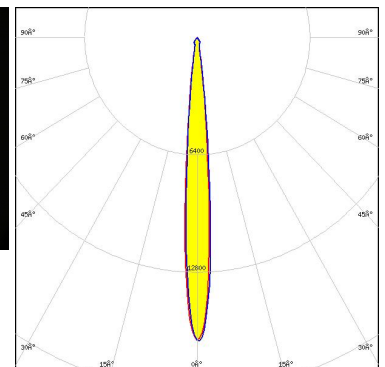

Light distribution files

OPTICAL RESULTS (MEASURED):

CITIZEN

LED CLL03x/CLU03x
 FWHM / FWTM 10.0° / 18.0°
 Efficiency 88 %
 Peak intensity 15 cd/lm
 LEDs/each optic 1
 Light colour/type White
 Required components:
 C13658_CLAMP-VERO13-18
 Bender Wirth: 433 Typ L1

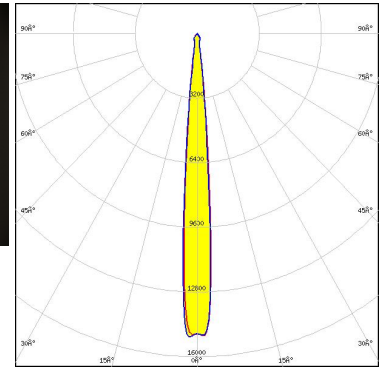

Light distribution files

CITIZEN

LED CLL04x/CLU04x
 FWHM / FWTM 14.0° / 31.0°
 Efficiency 89 %
 Peak intensity 6.8 cd/lm
 LEDs/each optic 1
 Light colour/type White
 Required components:
 C13584_CLAMP-VERO29
 Bender Wirth: 431 Typ L3

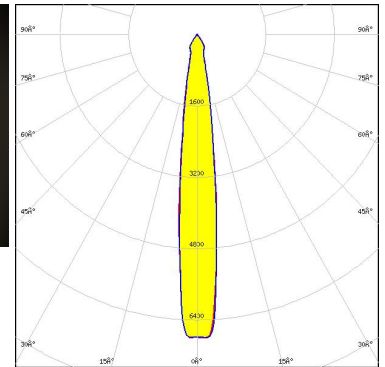

Light distribution files

CITIZEN

LED CLL04x/CLU04x
 FWHM / FWTM 16.0° / 37.0°
 Efficiency 85 %
 Peak intensity 5.2 cd/lm
 LEDs/each optic 1
 Light colour/type White
 Required components:
 F13671_ANGE-RZ-LENS
 IDEAL: 50-2204-CT + 50-2100AN

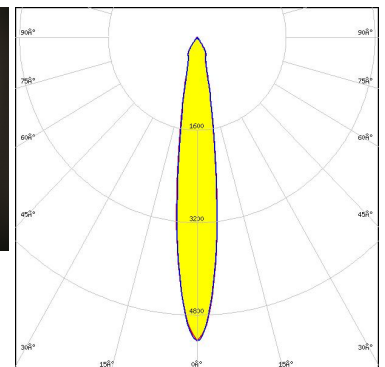
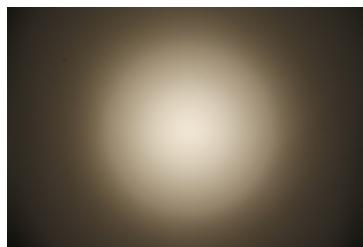

Light distribution files

OPTICAL RESULTS (MEASURED):

CITIZEN

LED CLU700/701/702/703
 FWHM / FWTM 5.0° / 9.0°
 Efficiency 88 %
 Peak intensity 57.8 cd/lm
 LEDs/each optic 1
 Light colour/type White
 Required components:
 C13658_CLAMP-VERO13-18
 Bender Wirth: 434 Typ L1

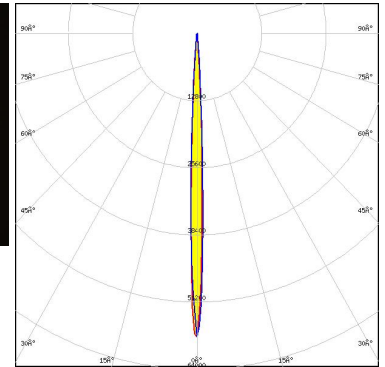

Light distribution files

CITIZEN

LED CLU720/721/723
 FWHM / FWTM 7.0° / 13.0°
 Efficiency 88 %
 Peak intensity 26.1 cd/lm
 LEDs/each optic 1
 Light colour/type White
 Required components:
 C13658_CLAMP-VERO13-18
 Bender Wirth: 433 Typ L1

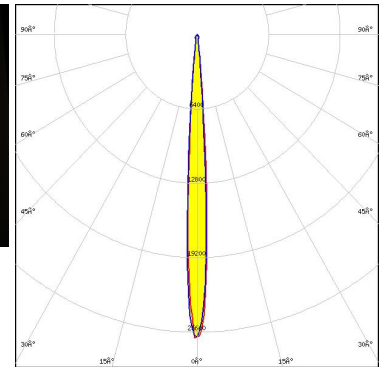

Light distribution files

CITIZEN

LED CLU720/721/723
 FWHM / FWTM 7.0° / 14.0°
 Efficiency 94 %
 Peak intensity 24 cd/lm
 LEDs/each optic 1
 Light colour/type White
 Required components:
 TE Connectivity: 2213254-2 + OPTIC CLIP Z50 TYPE1 2213194-1

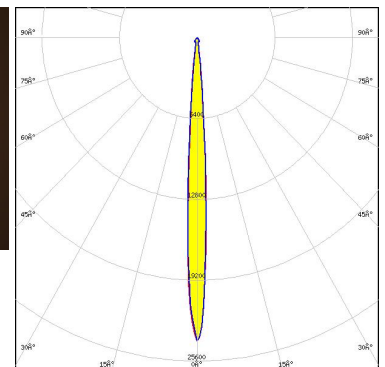
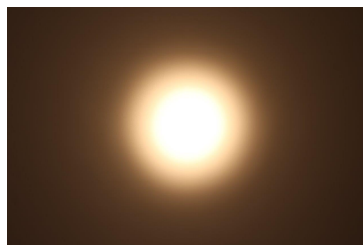

Light distribution files

OPTICAL RESULTS (MEASURED):

CITIZEN

LED CLU730/731/733
 FWHM / FWTM 10.0° / 24.0°
 Efficiency 85 %
 Peak intensity 10 cd/lm
 LEDs/each optic 1
 Light colour/type White
 Required components:
 F13671_ANGE-RZ-LENS
 IDEAL: 50-2204-CT + 50-2100AN

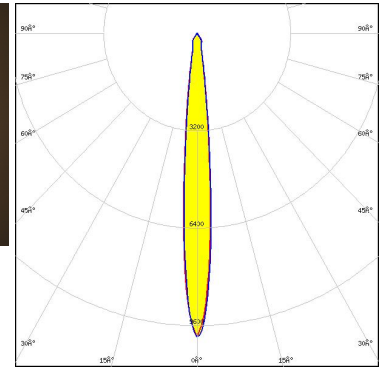

Light distribution files

CITIZEN

LED CLU730/731/733
 FWHM / FWTM 8.0° / 18.0°
 Efficiency 88 %
 Peak intensity 16.3 cd/lm
 LEDs/each optic 1
 Light colour/type White
 Required components:
 IDEAL: 50-2204-CT + 50-2100AN

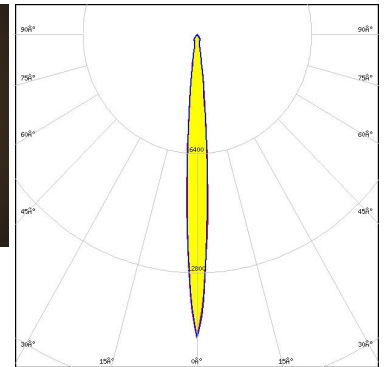

Light distribution files

CITIZEN

LED CLU730/731/733
 FWHM / FWTM 8.5° / 16.0°
 Efficiency 91 %
 Peak intensity 18.9 cd/lm
 LEDs/each optic 1
 Light colour/type White
 Required components:
 C13584_CLAMP-VERO29
 Bender Wirth: 471 Typ L3

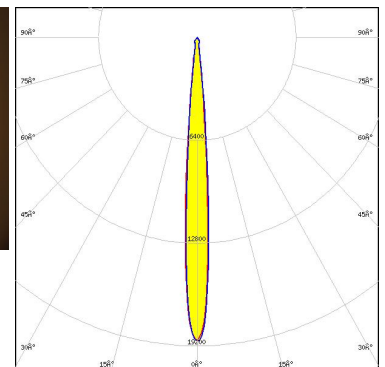

Light distribution files

OPTICAL RESULTS (MEASURED):



LED CMA1840
FWHM / FWTM 9.7° / 17.0°
Efficiency 93 %
Peak intensity 16.9 cd/lm
LEDs/each optic 1
Light colour/type White
Required components:
 C14123_CLAMP-CXA15-18

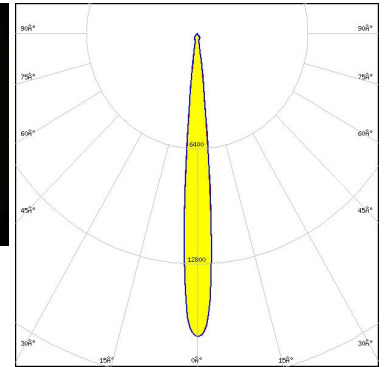

Light distribution files



LED CMA2550
FWHM / FWTM 13.0° / 24.0°
Efficiency 92 %
Peak intensity 10 cd/lm
LEDs/each optic 1
Light colour/type White
Required components:
 C14036_CLAMP_CXA25-30

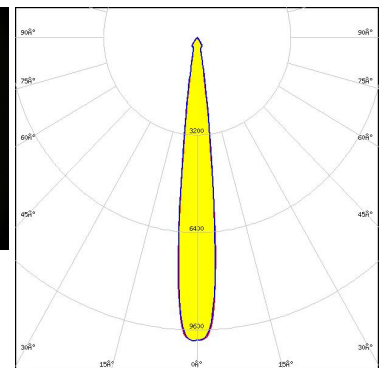
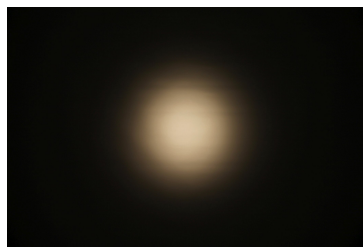

Light distribution files



LED CMA3090
FWHM / FWTM 15.0° / 30.0°
Efficiency 92 %
Peak intensity 7 cd/lm
LEDs/each optic 1
Light colour/type White
Required components:
 C14036_CLAMP_CXA25-30

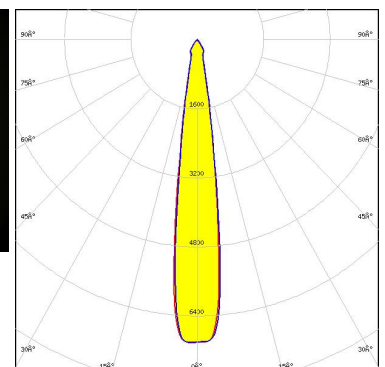
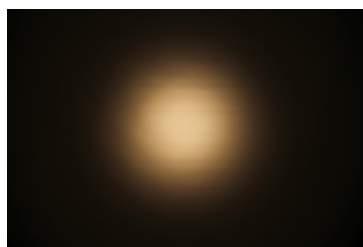

Light distribution files

OPTICAL RESULTS (MEASURED):



LED CMT14xx
FWHM / FWTM 7.0° / 12.0°
Efficiency 93 %
Peak intensity 33 cd/lm
LEDs/each optic 1
Light colour/type White
Required components:
 C13658_CLAMP-VERO13-18
 Bender Wirth: 434 Typ L1

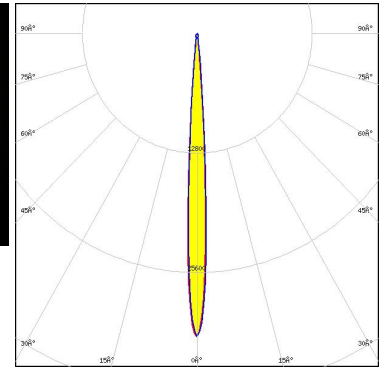
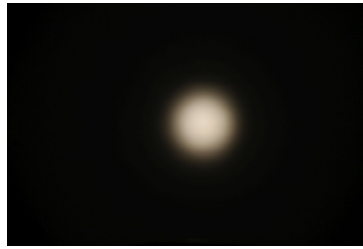

Light distribution files



LED CMT19xx
FWHM / FWTM 10.0° / 18.0°
Efficiency 92 %
Peak intensity 16.1 cd/lm
LEDs/each optic 1
Light colour/type White
Required components:
 C13658_CLAMP-VERO13-18
 Bender Wirth: 477 Typ L1

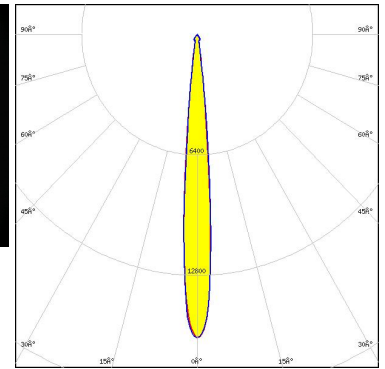
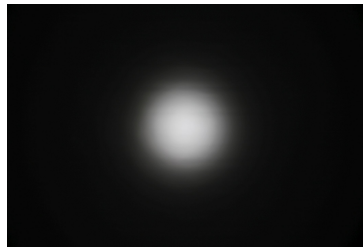

Light distribution files



LED CMT28xx
FWHM / FWTM 15.0° / 30.0°
Efficiency 91 %
Peak intensity 7.1 cd/lm
LEDs/each optic 1
Light colour/type White
Required components:
 C13584_CLAMP-VERO29
 Bender Wirth: 471 Typ L3

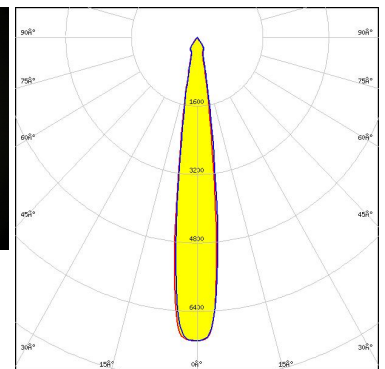
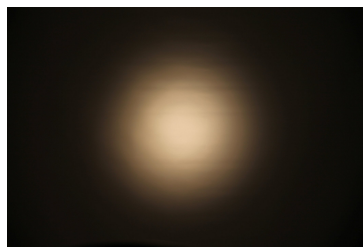

Light distribution files

OPTICAL RESULTS (MEASURED):



LED CXA/B 15xx
 FWHM / FWTM 5.8° / 11.0°
 Efficiency 92 %
 Peak intensity 37.6 cd/lm
 LEDs/each optic 1
 Light colour/type White
 Required components:
 C13658_CLAMP-VERO13-18
 Bender Wirth: 441 Typ L1

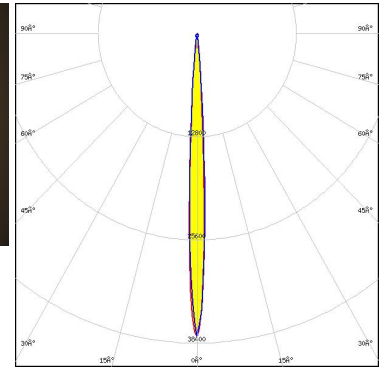

Light distribution files



LED CXA/B 1816 & CXA/B 1820 & CXA 1850
 FWHM / FWTM 8.0° / 14.0°
 Efficiency 89 %
 Peak intensity 22.6 cd/lm
 LEDs/each optic 1
 Light colour/type White
 Required components:
 C13658_CLAMP-VERO13-18
 Bender Wirth: 437 Typ L1

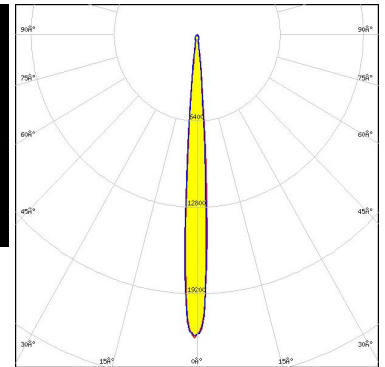

Light distribution files



LED CXA/B 1816 & CXA/B 1820 & CXA 1850
 FWHM / FWTM 9.0° / 15.0°
 Efficiency 91 %
 Peak intensity 24.7 cd/lm
 LEDs/each optic 1
 Light colour/type White
 Required components:
 C14123_CLAMP-CXA15-18

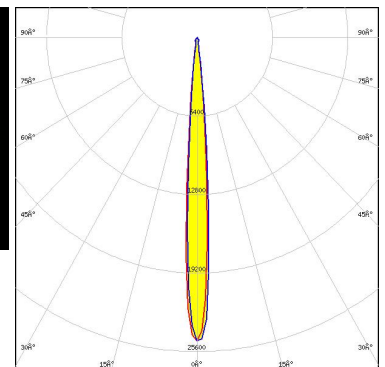
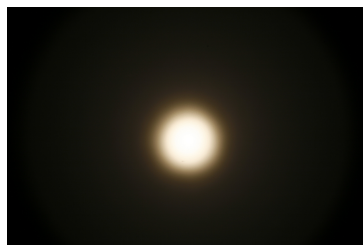

Light distribution files

OPTICAL RESULTS (MEASURED):



LED CXA/B 25xx
 FWHM / FWTM 11.0° / 21.0°
 Efficiency 92 %
 Peak intensity 11.7 cd/lm
 LEDs/each optic 1
 Light colour/type White
 Required components:
 C14036_CLAMP_CXA25-30

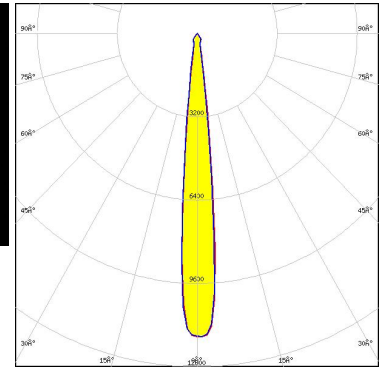

Light distribution files



LED CXA/B 30xx
 FWHM / FWTM 14.0° / 29.0°
 Efficiency 92 %
 Peak intensity 7.3 cd/lm
 LEDs/each optic 1
 Light colour/type White
 Required components:
 C14036_CLAMP_CXA25-30

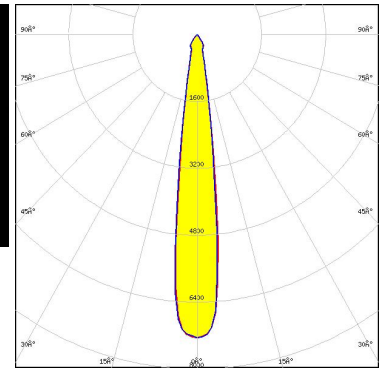
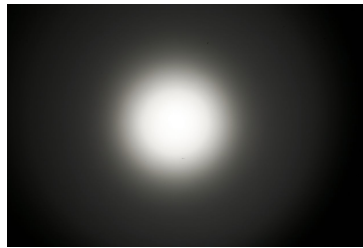

Light distribution files



LED CHI3030 19W
 FWHM / FWTM 14.0° / 35.0°
 Efficiency 85 %
 Peak intensity 6.1 cd/lm
 LEDs/each optic 1
 Light colour/type White
 Required components:
 C13584_CLAMP-VERO29
 F13671_ANGE-RZ-LENS
 Bender Wirth: 468 Typ L3

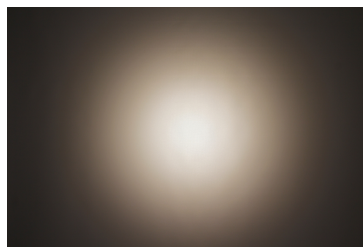

Light distribution files

OPTICAL RESULTS (MEASURED):

EVERLIGHT

LED CHI3030 29W
FWHM / FWTM 18.0° / 47.0°
Efficiency 85 %
Peak intensity 5.1 cd/lm
LEDs/each optic 1
Light colour/type White

Required components:

C13584_CLAMP-VERO29
F13671_ANGE-RZ-LENS
Bender Wirth: 468 Typ L3

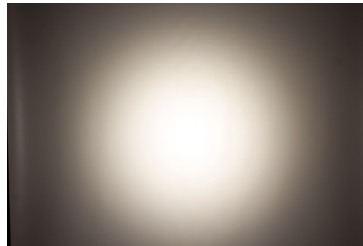

Light distribution files

inventronics

LED PrevaLED Core AC (LEP-2000)
FWHM / FWTM 11.0° / 23.0°
Efficiency 92 %
Peak intensity 11.2 cd/lm
LEDs/each optic 1
Light colour/type White

Required components:

TE Connectivity: OPTIC CLIP Z50 TYPE1 2213194-1

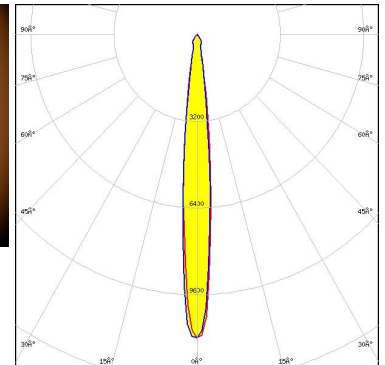
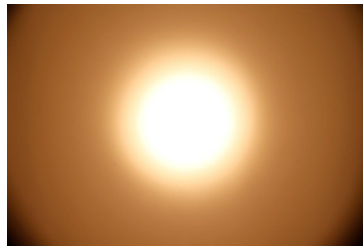

Light distribution files

inventronics

LED PrevaLED Core AC (LEP-800)
FWHM / FWTM 8.0° / 17.0°
Efficiency 94 %
Peak intensity 19.8 cd/lm
LEDs/each optic 1
Light colour/type White

Required components:

TE Connectivity: OPTIC CLIP Z50 TYPE1 2213194-1

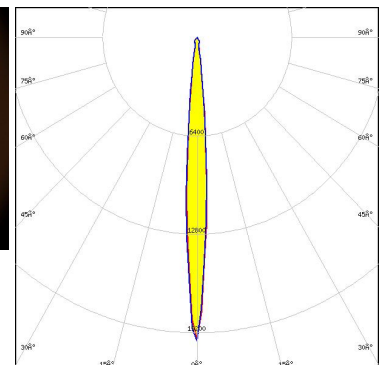
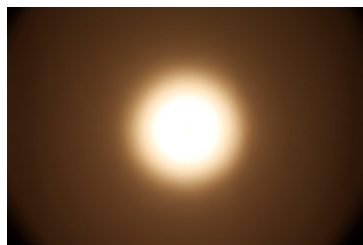

Light distribution files

OPTICAL RESULTS (MEASURED):

inventronics

LED PrevaLED Core G7 L15 H1
FWHM / FWTM 11.0° / 24.0°
Efficiency 89 %
Peak intensity 10.3 cd/lm
LEDs/each optic 1
Light colour/type White
Required components:
C16685_CLAMP-PRV-A
F13671_ANGE-RZ-LENS

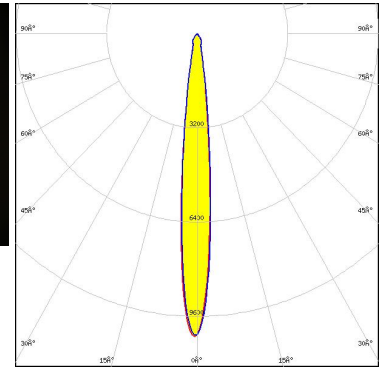

Light distribution files

inventronics

LED PrevaLED Core G7 L15 H1
FWHM / FWTM 10.0° / 20.0°
Efficiency 93 %
Peak intensity 14.4 cd/lm
LEDs/each optic 1
Light colour/type White
Required components:
C16685_CLAMP-PRV-A

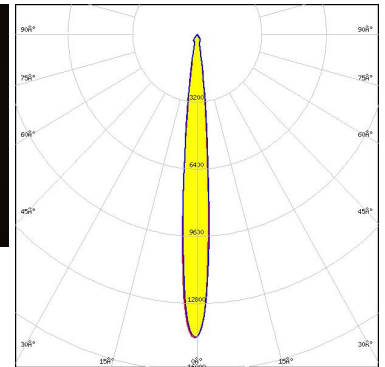
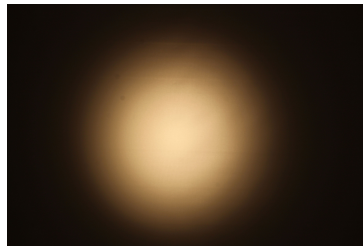

Light distribution files

inventronics

LED PrevaLED Core Z3 LES19
FWHM / FWTM 10.0° / 21.0°
Efficiency 93 %
Peak intensity 13 cd/lm
LEDs/each optic 1
Light colour/type White
Required components:
TE Connectivity: OPTIC CLIP Z50 TYPE1 2213194-1

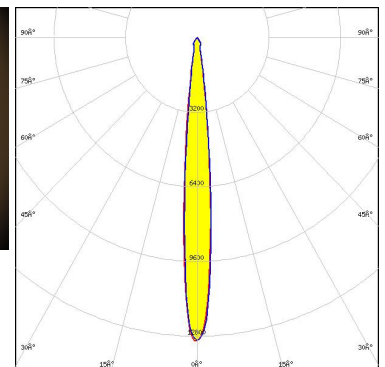

Light distribution files

OPTICAL RESULTS (MEASURED):

inventronics

LED PrevaLED Core Z3 LES23
 FWHM / FWTM 13.0° / 27.0°
 Efficiency 93 %
 Peak intensity 8.8 cd/lm
 LEDs/each optic 1
 Light colour/type White
 Required components:
 TE Connectivity: OPTIC CLIP Z50 TYPE1 2213194-1

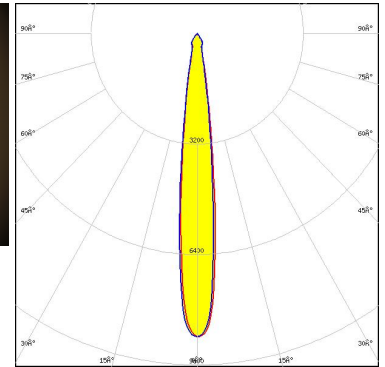

Light distribution files

inventronics

LED PrevaLED Core Z3 LES9
 FWHM / FWTM 6.0° / 12.0°
 Efficiency 94 %
 Peak intensity 36 cd/lm
 LEDs/each optic 1
 Light colour/type White
 Required components:
 TE Connectivity: OPTIC CLIP Z50 TYPE1 2213194-1

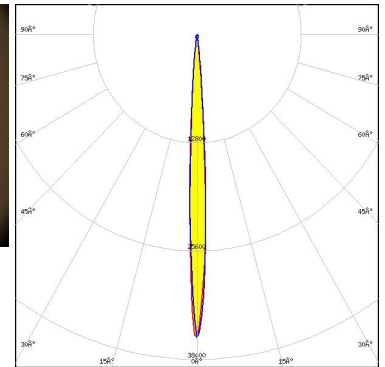

Light distribution files

inventronics

LED PrevaLED Core Z4 LES19
 FWHM / FWTM 10.0° / 21.0°
 Efficiency 93 %
 Peak intensity 13.3 cd/lm
 LEDs/each optic 1
 Light colour/type White
 Required components:
 TE Connectivity: OPTIC CLIP Z50 TYPE1 2213194-1

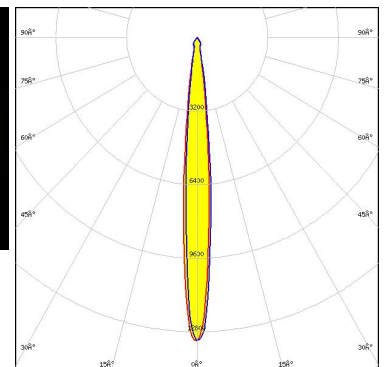

Light distribution files

OPTICAL RESULTS (MEASURED):

inventronics

LED PrevaLED Core Z4 LES19
 FWHM / FWTM 12.0° / 28.0°
 Efficiency 85 %
 Peak intensity 8.1 cd/lm
 LEDs/each optic 1
 Light colour/type White
 Required components:
 F13671_ANGE-RZ-LENS
 TE Connectivity: OPTIC CLIP Z50 TYPE1 2213194-1

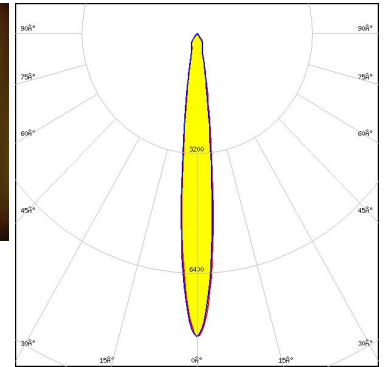
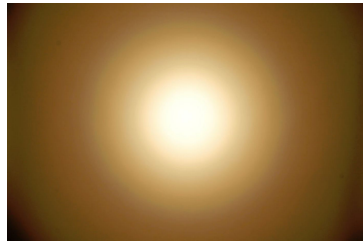

Light distribution files

LUMILEDS

LED LUXEON CoB 1202/1203
 FWHM / FWTM 6.0° / 11.0°
 Efficiency 91 %
 Peak intensity 36 cd/lm
 LEDs/each optic 1
 Light colour/type White
 Required components:
 C13658_CLAMP-VERO13-18
 Bender Wirth: 438 Typ L1

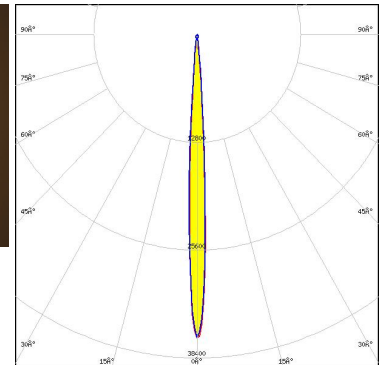

Light distribution files

LUMILEDS

LED LUXEON CoB 1204/1205
 FWHM / FWTM 10.0° / 22.0°
 Efficiency 85 %
 Peak intensity 13.1 cd/lm
 LEDs/each optic 1
 Light colour/type White
 Required components:
 F13671_ANGE-RZ-LENS
 TE Connectivity: 2213130-2 + OPTIC CLIP Z50 TYPE1 2213194-1

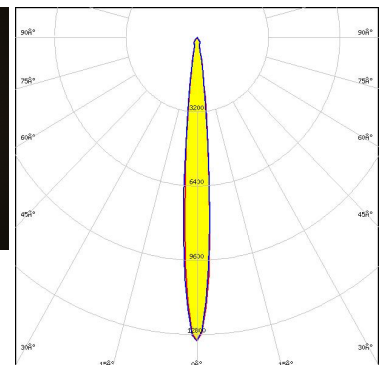
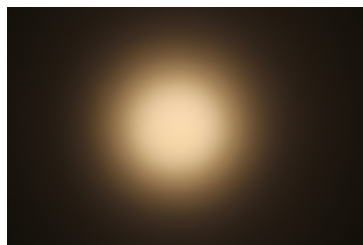

Light distribution files

OPTICAL RESULTS (MEASURED):



LED LUXEON CoB 1204/1205
FWHM / FWTM 8.0° / 16.0°
Efficiency 94 %
Peak intensity 19.9 cd/lm
LEDs/each optic 1
Light colour/type White

Required components:

TE Connectivity: 2213130-2 + OPTIC CLIP Z50 TYPE1 2213194-1

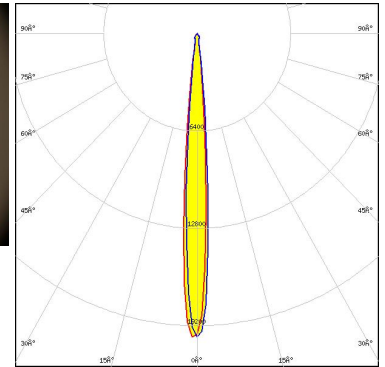

Light distribution files



LED LUXEON CoB 1204HD
FWHM / FWTM 6.4° / 12.0°
Efficiency 93 %
Peak intensity 34 cd/lm
LEDs/each optic 1
Light colour/type White

Required components:

TE Connectivity: 2213382-2 + OPTIC CLIP Z50 TYPE1 2213194-1

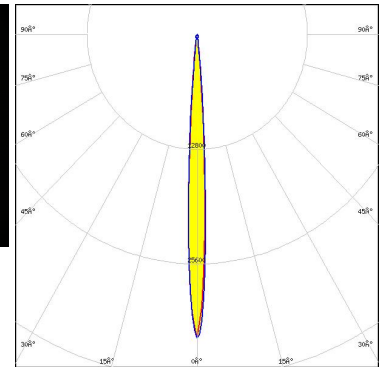
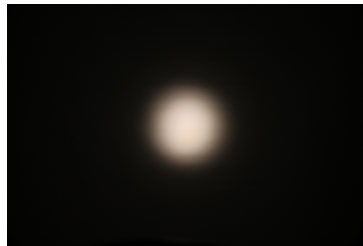

Light distribution files



LED LUXEON CoB 1205HD
FWHM / FWTM 7.5° / 15.0°
Efficiency 93 %
Peak intensity 24.8 cd/lm
LEDs/each optic 1
Light colour/type White

Required components:

TE Connectivity: 2213382-2 + OPTIC CLIP Z50 TYPE1 2213194-1

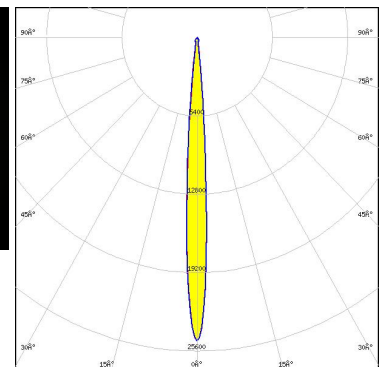

Light distribution files

OPTICAL RESULTS (MEASURED):



LED LUXEON CoB 1208
 FWHM / FWTM 12.0° / 27.0°
 Efficiency 88 %
 Peak intensity 8.6 cd/lm
 LEDs/each optic 1
 Light colour/type White
 Required components:
 IDEAL: 50-2204-CT + 50-2100AN

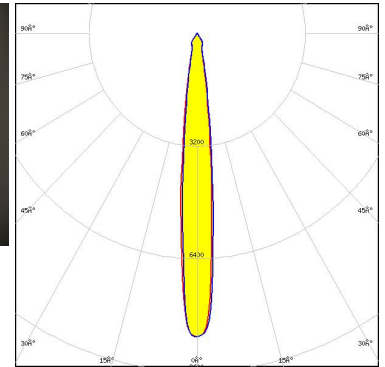

Light distribution files



LED LUXEON CoB 1208
 FWHM / FWTM 11.0° / 24.0°
 Efficiency 85 %
 Peak intensity 9.9 cd/lm
 LEDs/each optic 1
 Light colour/type White
 Required components:
 F13671_ANGE-RZ-LENS
 TE Connectivity: 2213130-2 + OPTIC CLIP Z50 TYPE1 2213194-1

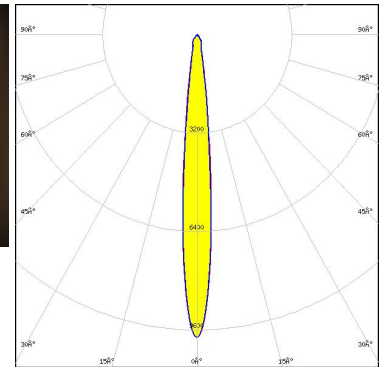

Light distribution files



LED LUXEON CoB 1208
 FWHM / FWTM 10.0° / 19.0°
 Efficiency 94 %
 Peak intensity 15.9 cd/lm
 LEDs/each optic 1
 Light colour/type White
 Required components:
 TE Connectivity: 2213130-2 + OPTIC CLIP Z50 TYPE1 2213194-1

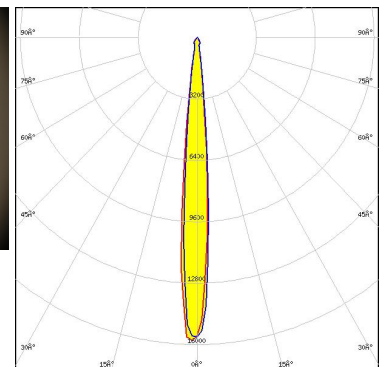

Light distribution files

OPTICAL RESULTS (MEASURED):



LED LUXEON CoB 1208
FWHM / FWTM 9.0° / 21.0°
Efficiency 89 %
Peak intensity 13 cd/lm
LEDs/each optic 1
Light colour/type White
Required components:
 IDEAL: 50-2100SH + 50-2100AN

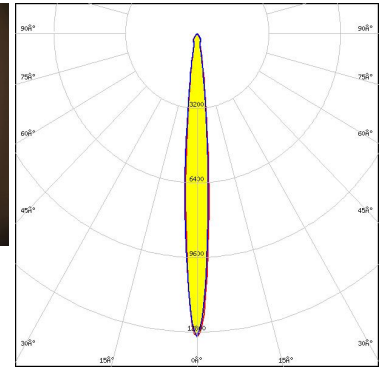

Light distribution files



LED LUXEON CoB 1208
FWHM / FWTM 12.0° / 28.0°
Efficiency 84 %
Peak intensity 8 cd/lm
LEDs/each optic 1
Light colour/type White
Required components:
 F13671_ANGE-RZ-LENS
 IDEAL: 50-2100SH + 50-2100AN

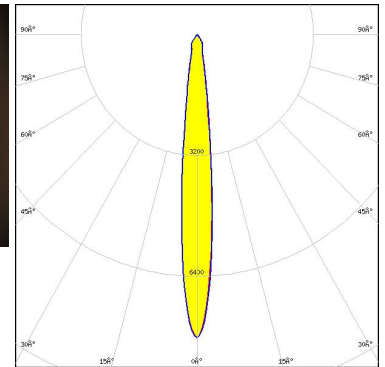

Light distribution files



LED LUXEON CoB 1211
FWHM / FWTM 13.0° / 25.0°
Efficiency 90 %
Peak intensity 9.2 cd/lm
LEDs/each optic 1
Light colour/type White
Required components:
 C13584_CLAMP-VERO29
 Bender Wirth: 431 Typ L3

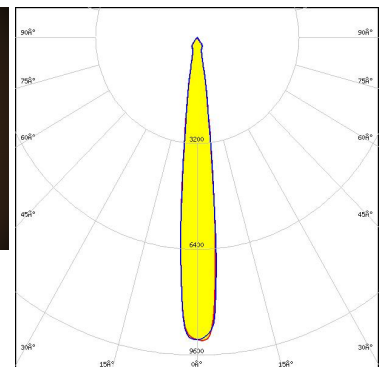

Light distribution files

OPTICAL RESULTS (MEASURED):



LED LUXEON CoB 1211
FWHM / FWTM 13.0° / 32.0°
Efficiency 84 %
Peak intensity 6.6 cd/lm
LEDs/each optic 1
Light colour/type White
Required components:
F13671_ANGE-RZ-LENS
IDEAL: 50-2204-CT + 50-2100AN

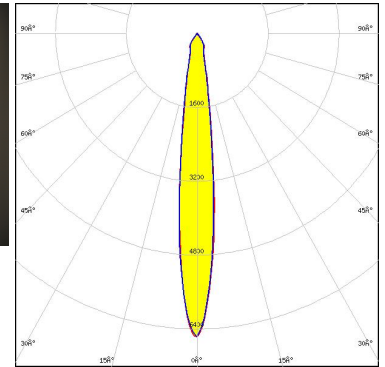

Light distribution files



LED LUXEON CoB 1213/1216/1812
FWHM / FWTM 16.0° / 39.0°
Efficiency 84 %
Peak intensity 4.9 cd/lm
LEDs/each optic 1
Light colour/type White
Required components:
F13671_ANGE-RZ-LENS
IDEAL: 50-2204-CT + 50-2100AN

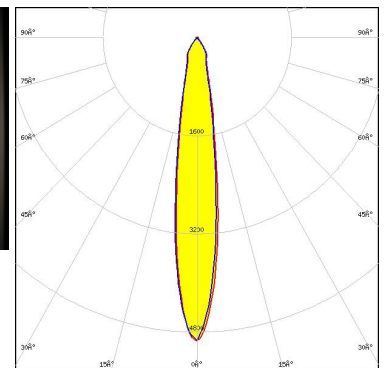
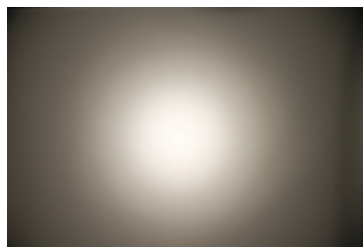

Light distribution files



LED LUXEON CoB 1213/1216/1812
FWHM / FWTM 14.0° / 33.0°
Efficiency 88 %
Peak intensity 6.3 cd/lm
LEDs/each optic 1
Light colour/type White
Required components:
IDEAL: 50-2204-CT + 50-2100AN

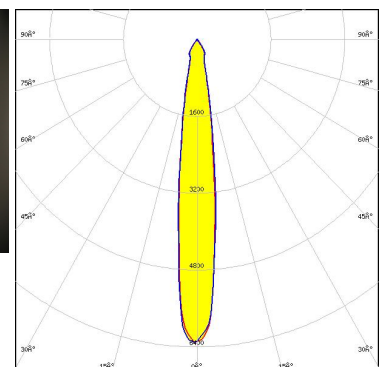
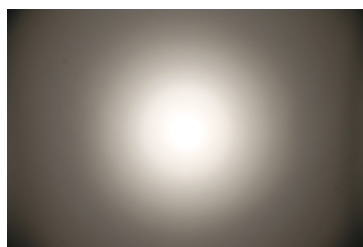

Light distribution files

OPTICAL RESULTS (MEASURED):



LED LUXEON K12
FWHM / FWTM 9.0° / 19.0°
Efficiency 90 %
Peak intensity 13 cd/lm
LEDs/each optic 1
Light colour/type White

Required components:

F13671_ANGE-RZ-LENS
TE Connectivity: 2213134-2 + OPTIC CLIP Z50 TYPE1 2213194-1

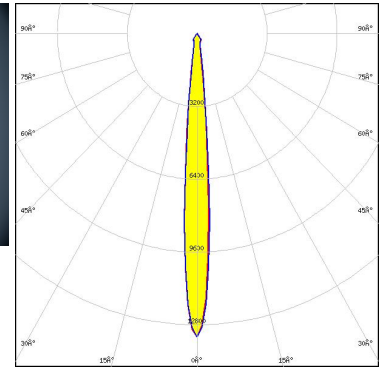

Light distribution files



LED LUXEON K16
FWHM / FWTM 10.0° / 22.0°
Efficiency 90 %
Peak intensity 11 cd/lm
LEDs/each optic 1
Light colour/type White

Required components:

F13671_ANGE-RZ-LENS
TE Connectivity: 2213134-2 + OPTIC CLIP Z50 TYPE1 2213194-1

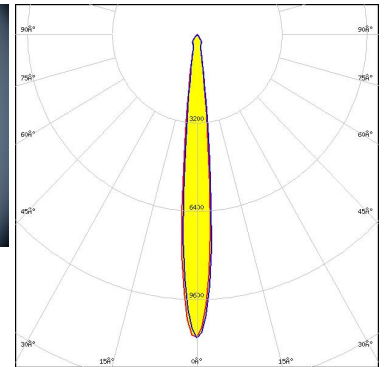

Light distribution files



LED LUXEON S2000
FWHM / FWTM 9.0° / 19.0°
Efficiency 87 %
Peak intensity 16 cd/lm
LEDs/each optic 1
Light colour/type White

Required components:

C13395_CLAMP-S2000
F13671_ANGE-RZ-LENS

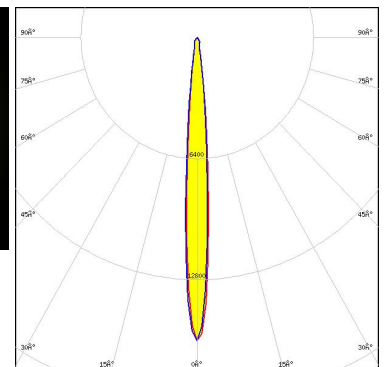

Light distribution files

OPTICAL RESULTS (MEASURED):



LED LUXEON S3000
FWHM / FWTM 10.0° / 21.0°
Efficiency 87 %
Peak intensity 13.8 cd/lm
LEDs/each optic 1
Light colour/type White
Required components:
 C13397_CLAMP-S3000
 F13671_ANGE-RZ-LENS

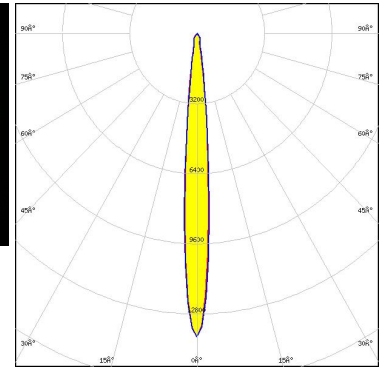

Light distribution files



LED LUXEON S5000
FWHM / FWTM 12.0° / 26.0°
Efficiency 86 %
Peak intensity 9.8 cd/lm
LEDs/each optic 1
Light colour/type White
Required components:
 C13399_CLAMP-S5000
 F13671_ANGE-RZ-LENS

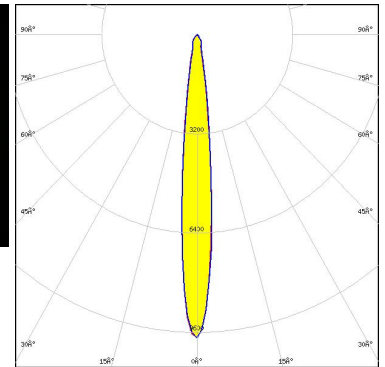

Light distribution files



LED CDM-14 (Dim-To-Warm)
FWHM / FWTM 9.5° / 21.0°
Efficiency 87 %
Peak intensity 13.4 cd/lm
LEDs/each optic 1
Light colour/type White
Required components:
 C13658_CLAMP-VERO13-18
 F13671_ANGE-RZ-LENS
 Bender Wirth: 491 Typ L2

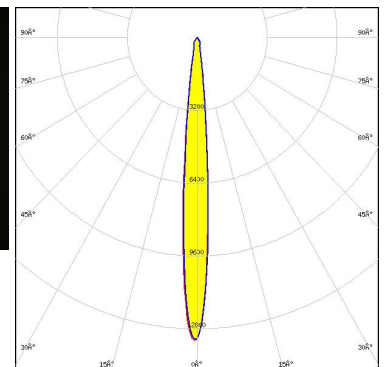

Light distribution files

OPTICAL RESULTS (MEASURED):



LED CDM-14 (Dim-To-Warm)
FWHM / FWTM 8.6° / 16.0°
Efficiency 92 %
Peak intensity 20.3 cd/lm
LEDs/each optic 1
Light colour/type White
Required components:
 C13658_CLAMP-VERO13-18
 Bender Wirth: 491 Typ L2

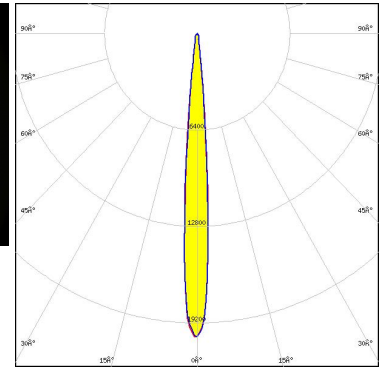

Light distribution files



LED CDM-18 (Dim-To-Warm)
FWHM / FWTM 11.0° / 25.0°
Efficiency 88 %
Peak intensity 10 cd/lm
LEDs/each optic 1
Light colour/type White
Required components:
 C13658_CLAMP-VERO13-18
 F13671_ANGE-RZ-LENS
 Bender Wirth: 491 Typ L2

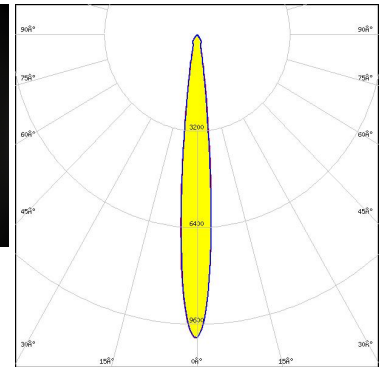

Light distribution files



LED CDM-18 (Dim-To-Warm)
FWHM / FWTM 11.0° / 21.0°
Efficiency 92 %
Peak intensity 12.8 cd/lm
LEDs/each optic 1
Light colour/type White
Required components:
 C13658_CLAMP-VERO13-18
 Bender Wirth: 491 Typ L2

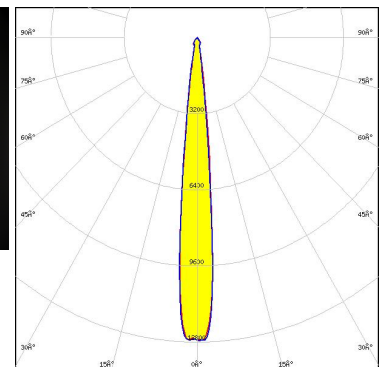

Light distribution files

OPTICAL RESULTS (MEASURED):



LED CDM-9 (Dim-To-Warm)
FWHM / FWTM 7.2° / 16.0°
Efficiency 85 %
Peak intensity 20.1 cd/lm
LEDs/each optic 1
Light colour/type White
Required components:
 C13658_CLAMP-VERO13-18
 F13671_ANGE-RZ-LENS
 Bender Wirth: 490 Typ L1

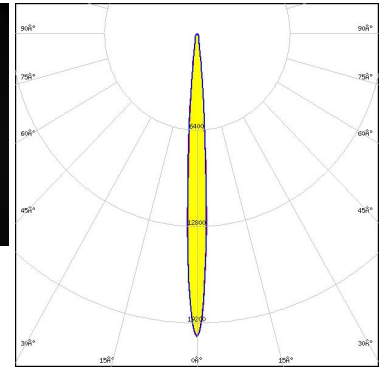

Light distribution files



LED CTM-14 (Tunable White)
FWHM / FWTM 9.0° / 21.0°
Efficiency 85 %
Peak intensity 12.5 cd/lm
LEDs/each optic 1
Light colour/type White
Required components:
 C13584_CLAMP-VERO29
 F13671_ANGE-RZ-LENS
 Bender Wirth: 442 Typ L3

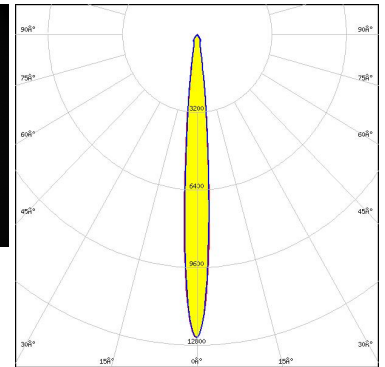

Light distribution files



LED CTM-14 (Tunable White)
FWHM / FWTM 8.0° / 16.0°
Efficiency 90 %
Peak intensity 19.6 cd/lm
LEDs/each optic 1
Light colour/type White
Required components:
 C13584_CLAMP-VERO29
 Bender Wirth: 442 Typ L3

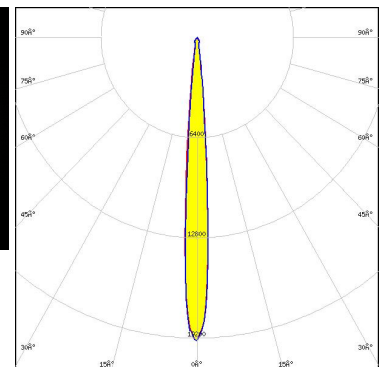

Light distribution files

OPTICAL RESULTS (MEASURED):



LED CTM-14 RGBW
FWHM / FWTM 9.0° / 20.0°
Efficiency 87 %
Peak intensity 14.4 cd/lm
LEDs/each optic 1
Light colour/type RGBW
Required components:
 C13584_CLAMP-VERO29
 F13671_ANGE-RZ-LENS
 Bender Wirth: 500 Typ L3-1

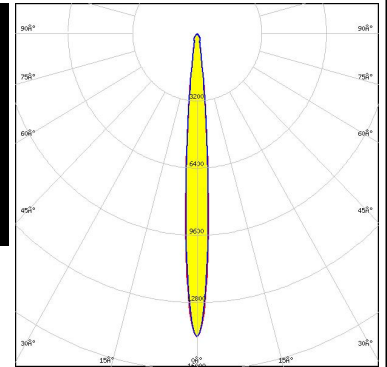
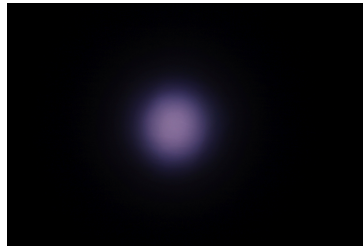

Light distribution files



LED CTM-14 RGBW
FWHM / FWTM 7.0° / 14.0°
Efficiency 92 %
Peak intensity 28.3 cd/lm
LEDs/each optic 1
Light colour/type RGBW
Required components:
 C13584_CLAMP-VERO29
 Bender Wirth: 500 Typ L3-1

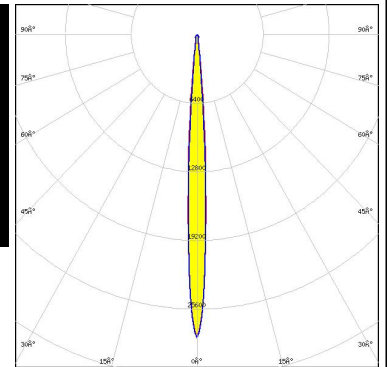
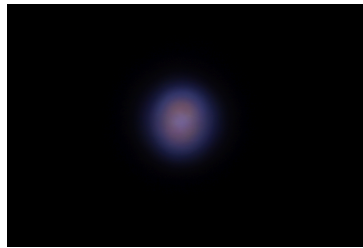

Light distribution files



LED CTM-22 (Tunable White)
FWHM / FWTM 15.0° / 33.0°
Efficiency 85 %
Peak intensity 6.3 cd/lm
LEDs/each optic 1
Light colour/type White
Required components:
 C13584_CLAMP-VERO29
 F13671_ANGE-RZ-LENS
 Bender Wirth: 494 Typ L3

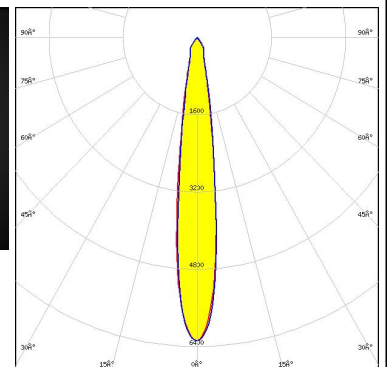
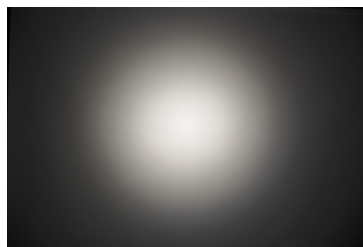

Light distribution files

OPTICAL RESULTS (MEASURED):



LED CTM-22 (Tunable White)
 FWHM / FWTM 14.0° / 28.0°
 Efficiency 90 %
 Peak intensity 7.9 cd/lm
 LEDs/each optic 1
 Light colour/type White
 Required components:
 C13584_CLAMP-VERO29
 Bender Wirth: 494 Typ L3

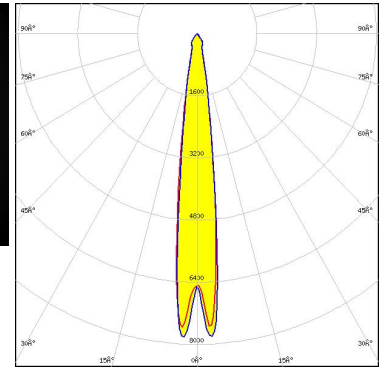

Light distribution files



LED CxM-14 (19x19)
 FWHM / FWTM 9.0° / 17.0°
 Efficiency 94 %
 Peak intensity 19 cd/lm
 LEDs/each optic 1
 Light colour/type White
 Required components:
 TE Connectivity: 2213254-2 + OPTIC CLIP Z50 TYPE1 2213194-1

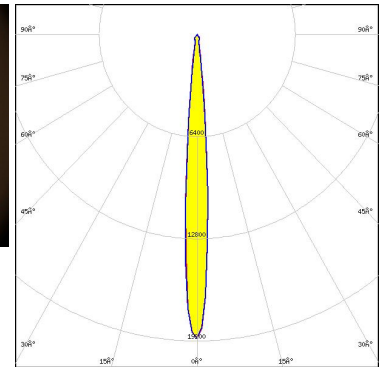
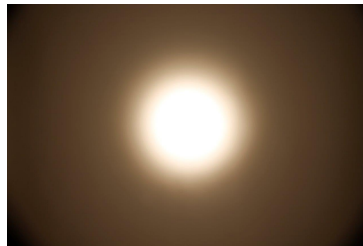

Light distribution files



LED COB J-Type
 FWHM / FWTM 9.0° / 18.0°
 Efficiency 89 %
 Peak intensity 15.2 cd/lm
 LEDs/each optic 1
 Light colour/type White
 Required components:
 C13658_CLAMP-VERO13-18
 Bender Wirth: 463 Typ L2

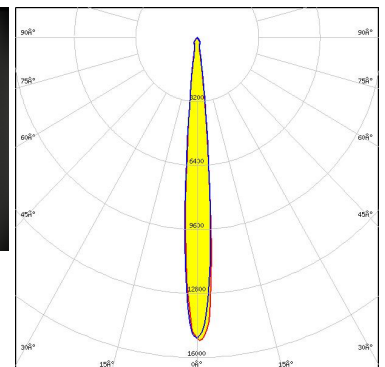

Light distribution files

OPTICAL RESULTS (MEASURED):



LED COB J-Type
FWHM / FWTM 9.0° / 22.0°
Efficiency 91 %
Peak intensity 12.7 cd/lm
LEDs/each optic 1
Light colour/type White
Required components:
 IDEAL: 50-2103NC + 50-2100AN

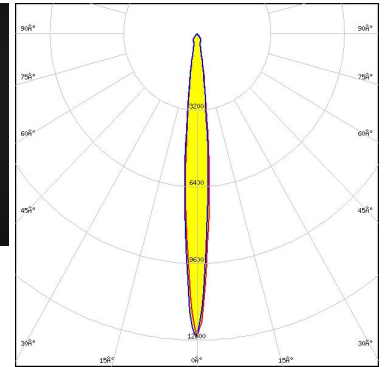

Light distribution files



LED COB J-Type
FWHM / FWTM 12.0° / 28.0°
Efficiency 86 %
Peak intensity 7.7 cd/lm
LEDs/each optic 1
Light colour/type White
Required components:
 F13671_ANGE-RZ-LENS
 IDEAL: 50-2103NC + 50-2100AN

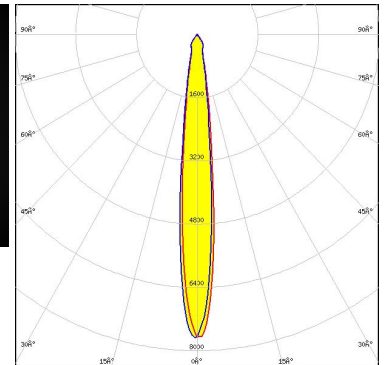

Light distribution files



LED COB L-Type (LES 11)
FWHM / FWTM 7.0° / 14.0°
Efficiency 89 %
Peak intensity 24.3 cd/lm
LEDs/each optic 1
Light colour/type White
Required components:
 C13658_CLAMP-VERO13-18
 Bender Wirth: 438 Typ L1

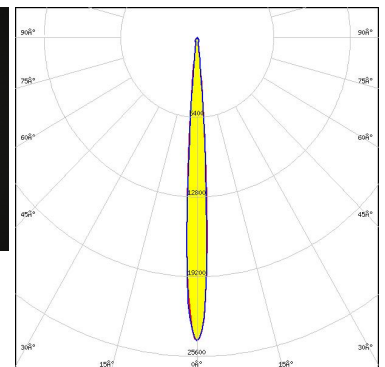

Light distribution files

OPTICAL RESULTS (MEASURED):

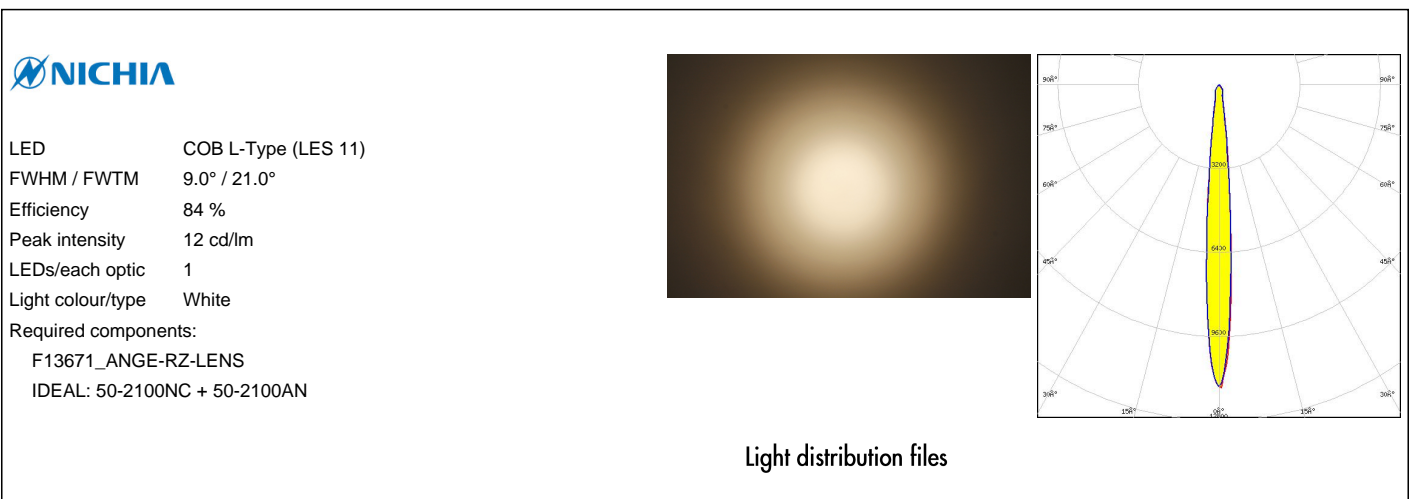
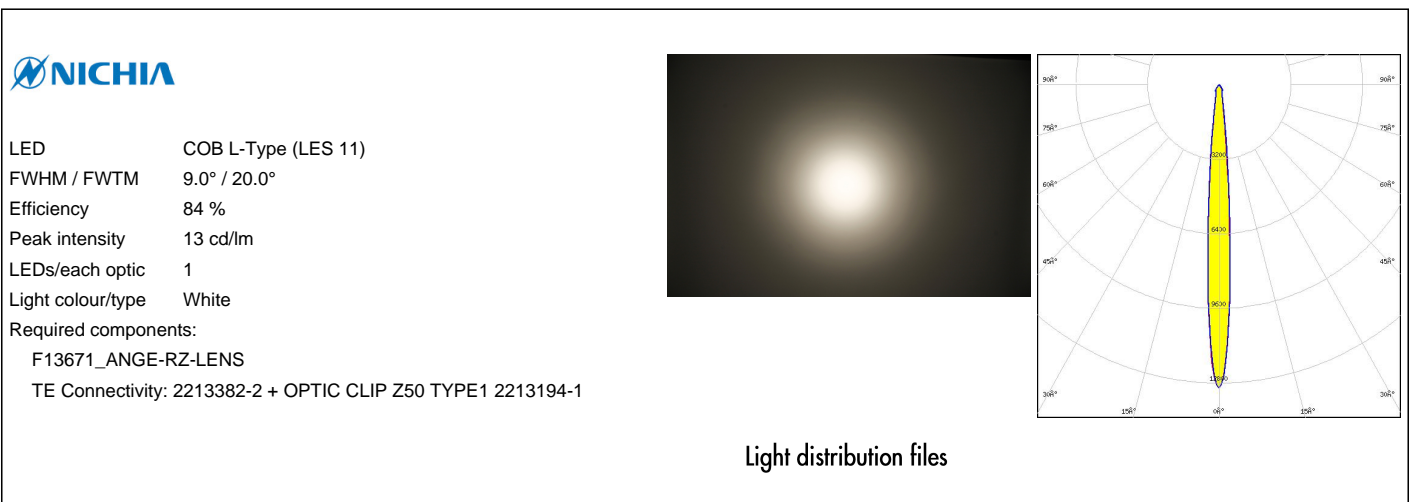
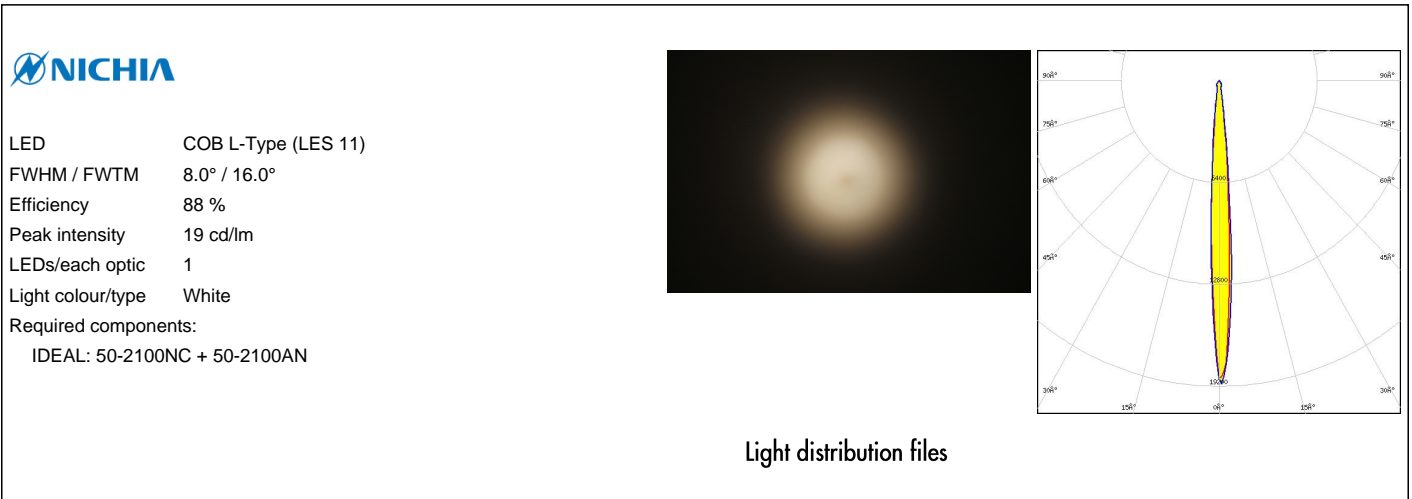

OPTICAL RESULTS (MEASURED):



LED COB L-Type (LES 11)
 FWHM / FWTM 8.0° / 14.0°
 Efficiency 94 %
 Peak intensity 24 cd/lm
 LEDs/each optic 1
 Light colour/type White
 Required components:
 Molex: 180580-0005

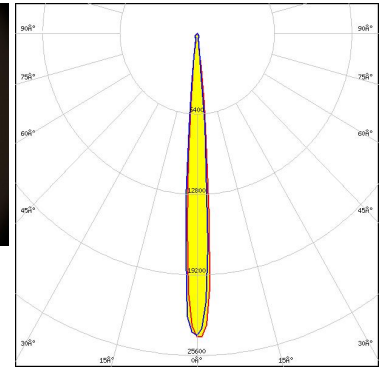

Light distribution files



LED COB L-Type (LES 9)
 FWHM / FWTM 6.0° / 11.0°
 Efficiency 93 %
 Peak intensity 39 cd/lm
 LEDs/each optic 1
 Light colour/type White
 Required components:
 C13658_CLAMP-VERO13-18
 Bender Wirth: 438 Typ L1

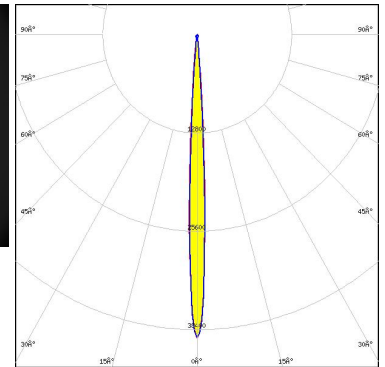

Light distribution files



LED NVCWJ024Z-V1MT: COB J-Type Tunable White
 FWHM / FWTM 9.0° / 19.0°
 Efficiency 86 %
 Peak intensity 14.4 cd/lm
 LEDs/each optic 1
 Light colour/type White
 Required components:
 C13658_CLAMP-VERO13-18
 F13671_ANGE-RZ-LENS
 Bender Wirth: 498 Typ L2

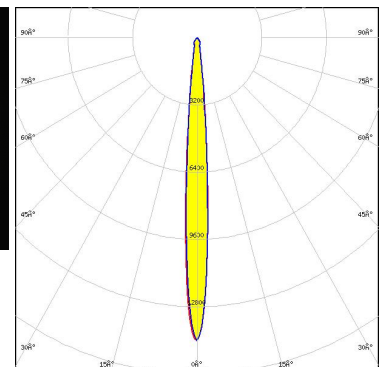

Light distribution files

OPTICAL RESULTS (MEASURED):



LED NVCWJ024Z-V1MT: COB J-Type Tunable White
FWHM / FWTM 7.0° / 13.0°
Efficiency 91 %
Peak intensity 28 cd/lm
LEDs/each optic 1
Light colour/type White
Required components:
 C13658_CLAMP-VERO13-18
 Bender Wirth: 498 Typ L2

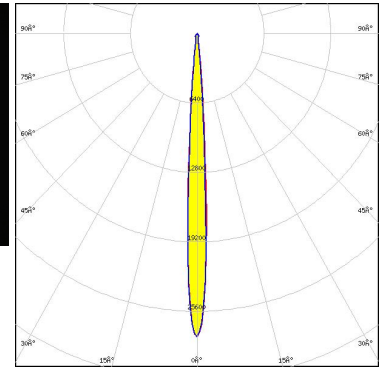
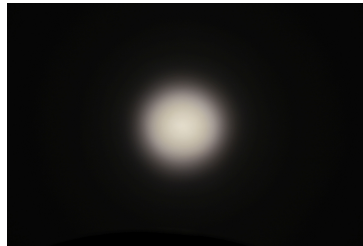

Light distribution files



LED Soleriq S13
FWHM / FWTM 8.0° / 15.0°
Efficiency 89 %
Peak intensity 21 cd/lm
LEDs/each optic 1
Light colour/type White
Required components:
 C13658_CLAMP-VERO13-18
 Bender Wirth: 437 Typ L1

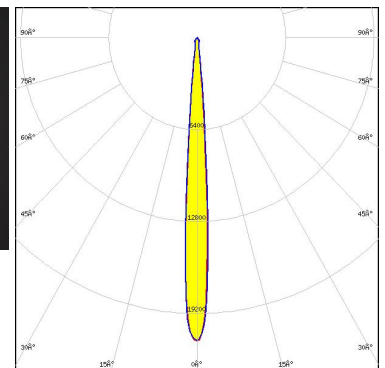
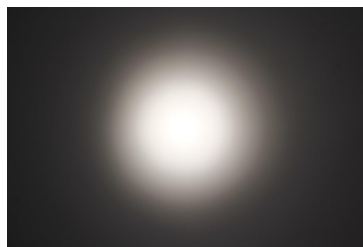

Light distribution files



LED Soleriq S13
FWHM / FWTM 8.0° / 15.0°
Efficiency 94 %
Peak intensity 22 cd/lm
LEDs/each optic 1
Light colour/type White
Required components:
 TE Connectivity: 2213401-2 + OPTIC CLIP Z50 TYPE1 2213194-1

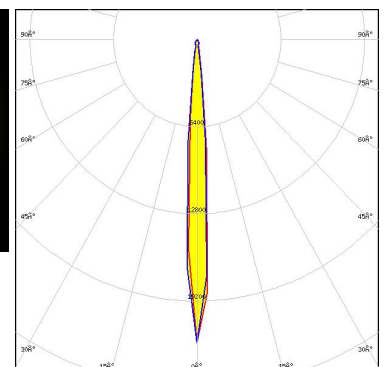

Light distribution files

OPTICAL RESULTS (MEASURED):

OSRAM
Opto Semiconductors

LED Soleriq S13 19x19
FWHM / FWTM 8.0° / 16.0°
Efficiency 90 %
Peak intensity 19 cd/lm
LEDs/each optic 1
Light colour/type White

Required components:

TE Connectivity: 2213254-2 + OPTIC CLIP Z50 TYPE1 2213194-1

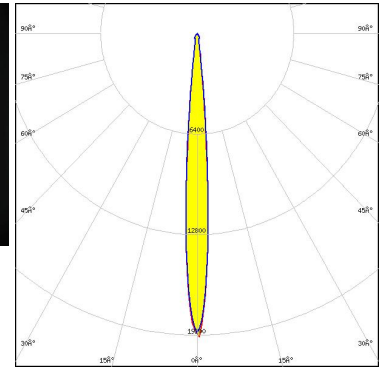

Light distribution files

OSRAM
Opto Semiconductors

LED Soleriq S13 19x19
FWHM / FWTM 10.0° / 23.0°
Efficiency 84 %
Peak intensity 11 cd/lm
LEDs/each optic 1
Light colour/type White

Required components:

F13671_ANGE-RZ-LENS

IDEAL: 50-2103CT + 50-2100AN

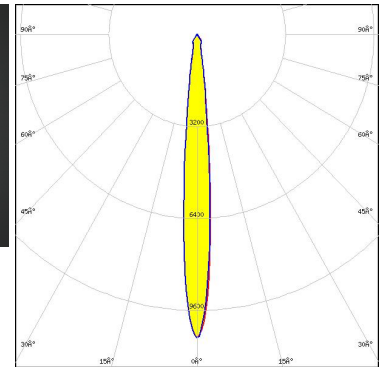

Light distribution files

OSRAM
Opto Semiconductors

LED Soleriq S13 19x19
FWHM / FWTM 8.0° / 18.0°
Efficiency 88 %
Peak intensity 16.9 cd/lm
LEDs/each optic 1
Light colour/type White

Required components:

IDEAL: 50-2103CT + 50-2100AN

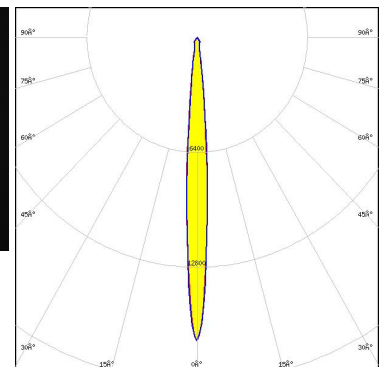

Light distribution files

OPTICAL RESULTS (MEASURED):

OSRAM
Opto Semiconductors

LED Soleriq S13 19x19
FWHM / FWMTM 9.0° / 20.0°
Efficiency 85 %
Peak intensity 13 cd/lm
LEDs/each optic 1
Light colour/type White

Required components:

F13671_ANGE-RZ-LENS

TE Connectivity: 2213254-2 + OPTIC CLIP Z50 TYPE1 2213194-1

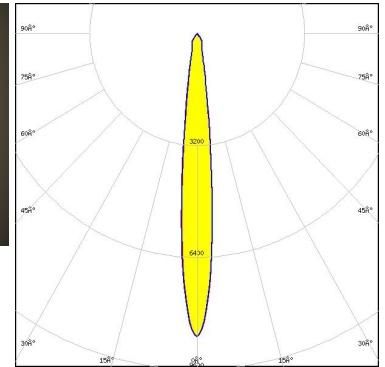

Light distribution files

OSRAM
Opto Semiconductors

LED Soleriq S19
FWHM / FWMTM 10.0° / 20.0°
Efficiency 94 %
Peak intensity 13.5 cd/lm
LEDs/each optic 1
Light colour/type White

Required components:

TE Connectivity: 2213407-2 + OPTIC CLIP Z50 TYPE1 2213194-1

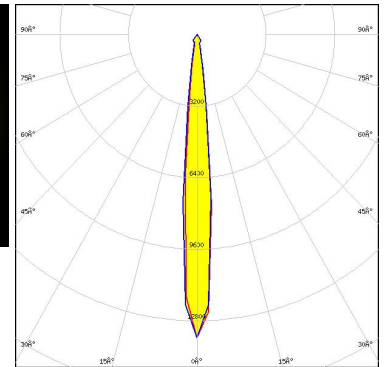
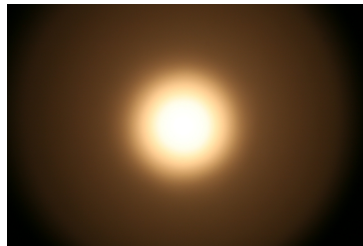

Light distribution files

OSRAM
Opto Semiconductors

LED Soleriq S19
FWHM / FWMTM 12.0° / 26.0°
Efficiency 85 %
Peak intensity 8.7 cd/lm
LEDs/each optic 1
Light colour/type White

Required components:

F13671_ANGE-RZ-LENS

TE Connectivity: 2213407-2 + OPTIC CLIP Z50 TYPE1 2213194-1

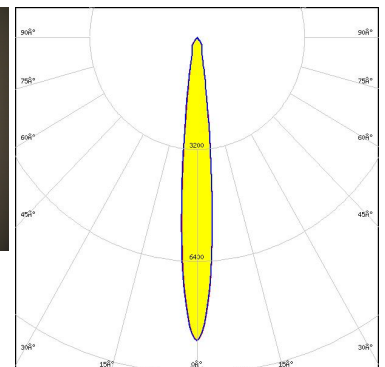

Light distribution files

OPTICAL RESULTS (MEASURED):

OSRAM
Opto Semiconductors

LED Soleriq S19
 FWHM / FWTM 11.0° / 23.0°
 Efficiency 90 %
 Peak intensity 11.5 cd/lm
 LEDs/each optic 1
 Light colour/type White
 Required components:
 C13584_CLAMP-VERO29
 Bender Wirth: 462 Typ L3

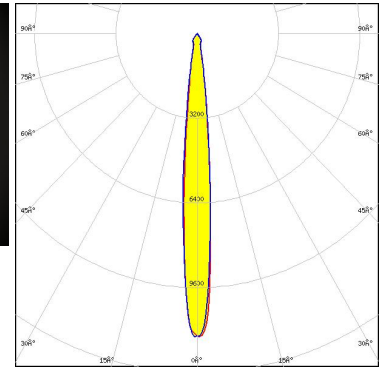

Light distribution files

PHILIPS

LED Fortimo SLM L09 + SLM holder
 FWHM / FWTM 7.0° / 13.0°
 Efficiency 91 %
 Peak intensity 30.6 cd/lm
 LEDs/each optic 1
 Light colour/type White
 Required components:
 TE Connectivity: OPTIC CLIP Z50 TYPE1 2213194-1

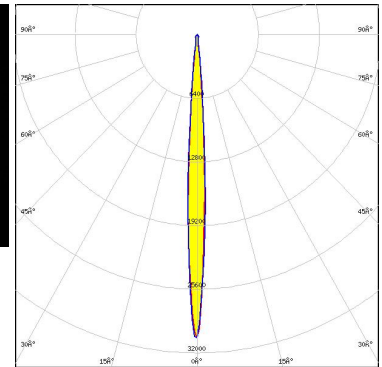

Light distribution files

PHILIPS

LED Fortimo SLM L13 + SLM holder
 FWHM / FWTM 8.5° / 17.0°
 Efficiency 91 %
 Peak intensity 17.8 cd/lm
 LEDs/each optic 1
 Light colour/type White
 Required components:
 TE Connectivity: OPTIC CLIP Z50 TYPE1 2213194-1

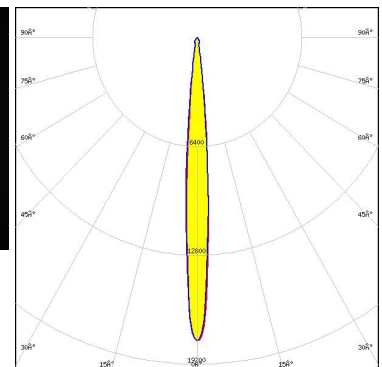

Light distribution files

OPTICAL RESULTS (MEASURED):

PHILIPS

LED Fortimo SLM L13 + SLM holder
 FWHM / FWTM 10.0° / 22.0°
 Efficiency 84 %
 Peak intensity 11 cd/lm
 LEDs/each optic 1
 Light colour/type White
 Required components:
 F13671_ANGE-RZ-LENS
 TE Connectivity: OPTIC CLIP Z50 TYPE1 2213194-1

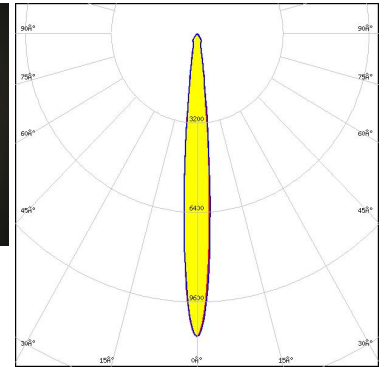

Light distribution files

PHILIPS

LED Fortimo SLM L13 CoB
 FWHM / FWTM 10.0° / 22.0°
 Efficiency 86 %
 Peak intensity 11.5 cd/lm
 LEDs/each optic 1
 Light colour/type White
 Required components:
 F13671_ANGE-RZ-LENS
 TE Connectivity: 2213130-2 + OPTIC CLIP Z50 TYPE1 2213194-1

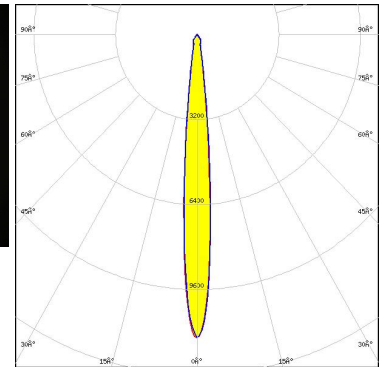

Light distribution files

PHILIPS

LED Fortimo SLM L13 CoB
 FWHM / FWTM 9.0° / 17.0°
 Efficiency 92 %
 Peak intensity 17.7 cd/lm
 LEDs/each optic 1
 Light colour/type White
 Required components:
 TE Connectivity: 2213130-2 + OPTIC CLIP Z50 TYPE1 2213194-1

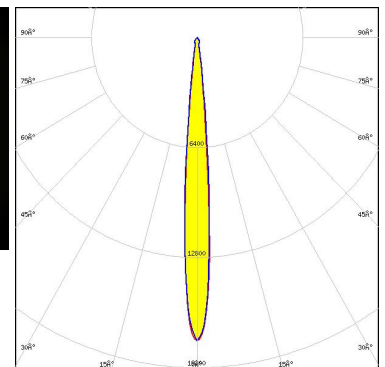

Light distribution files

OPTICAL RESULTS (MEASURED):

PHILIPS

LED Fortimo SLM L15 + SLM holder
 FWHM / FWTM 11.0° / 25.0°
 Efficiency 84 %
 Peak intensity 9.2 cd/lm
 LEDs/each optic 1
 Light colour/type White
 Required components:
 F13671_ANGE-RZ-LENS
 TE Connectivity: OPTIC CLIP Z50 TYPE1 2213194-1

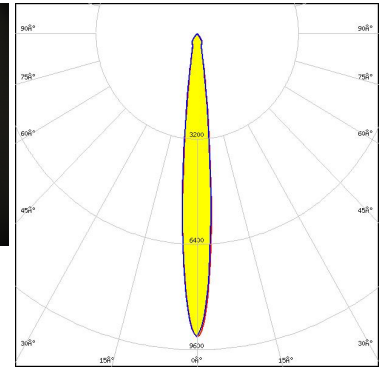

Light distribution files

PHILIPS

LED Fortimo SLM L15 + SLM holder
 FWHM / FWTM 10.0° / 20.0°
 Efficiency 89 %
 Peak intensity 13.9 cd/lm
 LEDs/each optic 1
 Light colour/type White
 Required components:
 TE Connectivity: OPTIC CLIP Z50 TYPE1 2213194-1

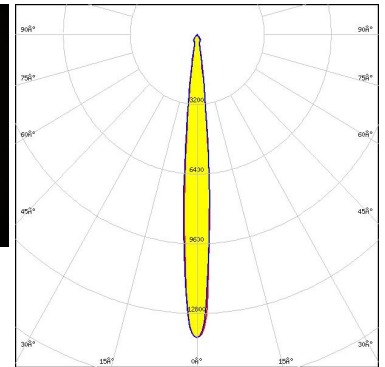

Light distribution files

PHILIPS

LED Fortimo SLM L15 CoB
 FWHM / FWTM 10.0° / 20.0°
 Efficiency 92 %
 Peak intensity 14.2 cd/lm
 LEDs/each optic 1
 Light colour/type White
 Required components:
 TE Connectivity: 2213130-2 + OPTIC CLIP Z50 TYPE1 2213194-1

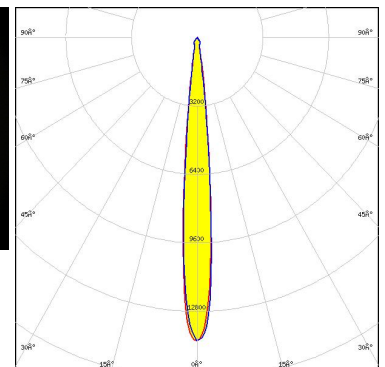

Light distribution files

OPTICAL RESULTS (MEASURED):

PHILIPS

LED Fortimo SLM L15 CoB
FWHM / FWTM 11.0° / 24.0°
Efficiency 86 %
Peak intensity 9.7 cd/lm
LEDs/each optic 1
Light colour/type White
Required components:
F13671_ANGE-RZ-LENS
TE Connectivity: 2213130-2 + OPTIC CLIP Z50 TYPE1 2213194-1

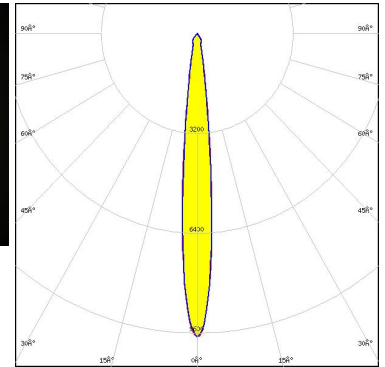

Light distribution files

PHILIPS

LED Fortimo SLM L19 + SLM holder
FWHM / FWTM 13.0° / 31.0°
Efficiency 84 %
Peak intensity 6.8 cd/lm
LEDs/each optic 1
Light colour/type White
Required components:
F13671_ANGE-RZ-LENS
TE Connectivity: OPTIC CLIP Z50 TYPE1 2213194-1

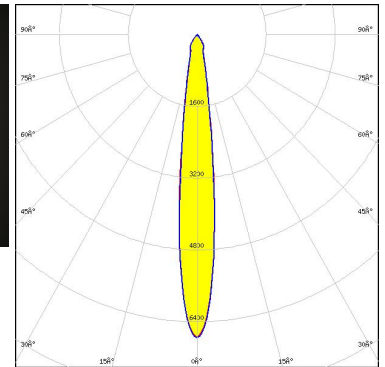

Light distribution files

PHILIPS

LED Fortimo SLM L19 + SLM holder
FWHM / FWTM 13.0° / 25.0°
Efficiency 88 %
Peak intensity 9 cd/lm
LEDs/each optic 1
Light colour/type White
Required components:
TE Connectivity: OPTIC CLIP Z50 TYPE1 2213194-1

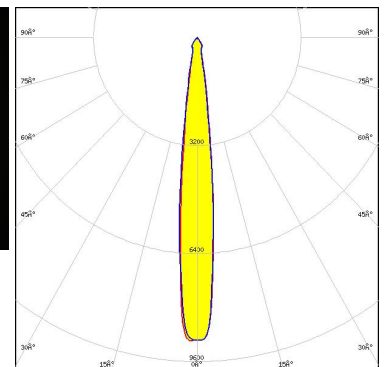

Light distribution files

OPTICAL RESULTS (MEASURED):

SAMSUNG

LED LC026B / 033B / 040B

FWHM / FWTM 11.0° / 22.0°

Efficiency 93 %

Peak intensity 11.8 cd/lm

LEDs/each optic 1

Light colour/type White

Required components:

TE Connectivity: 2213258-2 + OPTIC CLIP Z50 TYPE1 2213194-1

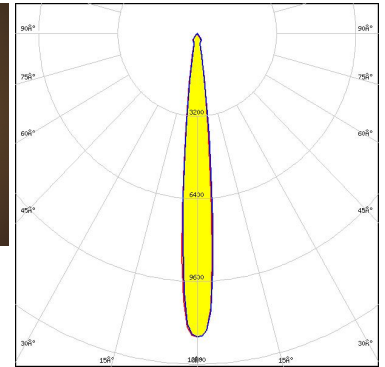

Light distribution files

SAMSUNG

LED LC026B / 033B / 040B

FWHM / FWTM 11.0° / 21.0°

Efficiency 8 %

Peak intensity 10.7 cd/lm

LEDs/each optic 1

Light colour/type White

Required components:

C13658_CLAMP-VERO13-18

Bender Wirth: 450 Typ L2

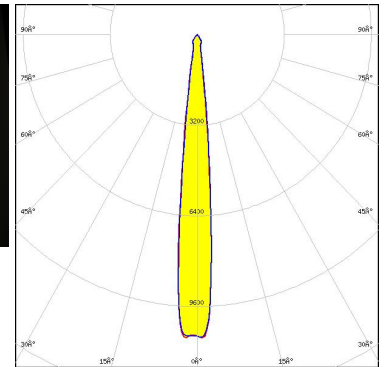

Light distribution files

SAMSUNG

LED LC035T (Tunable white)

FWHM / FWTM 15.0° / 35.0°

Efficiency 87 %

Peak intensity 5.9 cd/lm

LEDs/each optic 1

Light colour/type Tunable White

Required components:

C13584_CLAMP-VERO29

F13671_ANGE-RZ-LENS

Bender Wirth: 502 Typ L3

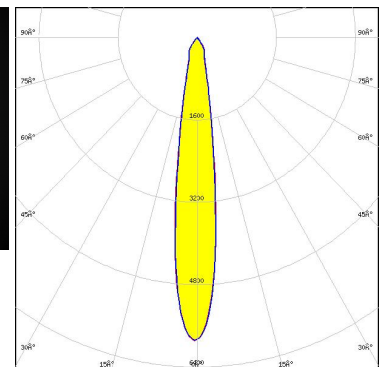

Light distribution files

OPTICAL RESULTS (MEASURED):

SAMSUNG

LED LC035T (Tunable white)
 FWHM / FWTM 15.0° / 30.0°
 Efficiency 92 %
 Peak intensity 7.3 cd/lm
 LEDs/each optic 1
 Light colour/type Tunable White
 Required components:
 C13584_CLAMP-VERO29
 Bender Wirth: 502 Typ L3

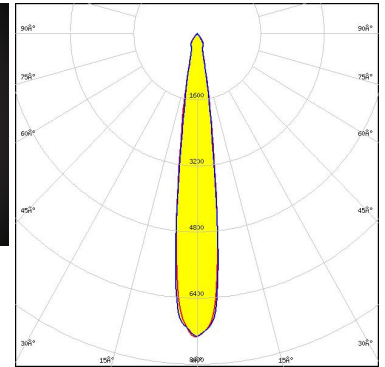

Light distribution files

SAMSUNG

LED LC040C
 FWHM / FWTM 9.0° / 19.0°
 Efficiency 85 %
 Peak intensity 14 cd/lm
 LEDs/each optic 1
 Light colour/type White
 Required components:
 F13671_ANGE-RZ-LENS
 TE Connectivity: 2213382-2 + OPTIC CLIP Z50 TYPE1 2213194-1

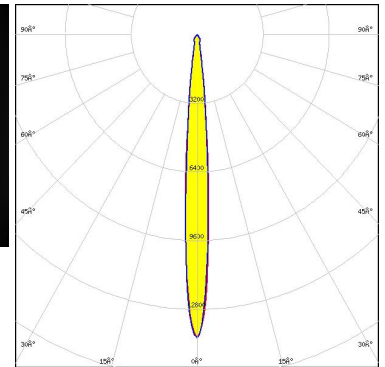

Light distribution files

SAMSUNG

LED LC040C
 FWHM / FWTM 7.0° / 15.0°
 Efficiency 89 %
 Peak intensity 23 cd/lm
 LEDs/each optic 1
 Light colour/type White
 Required components:
 TE Connectivity: 2213382-2 + OPTIC CLIP Z50 TYPE1 2213194-1

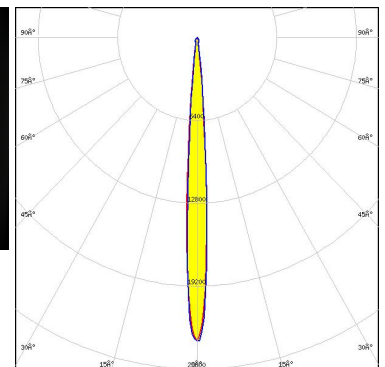

Light distribution files

OPTICAL RESULTS (MEASURED):

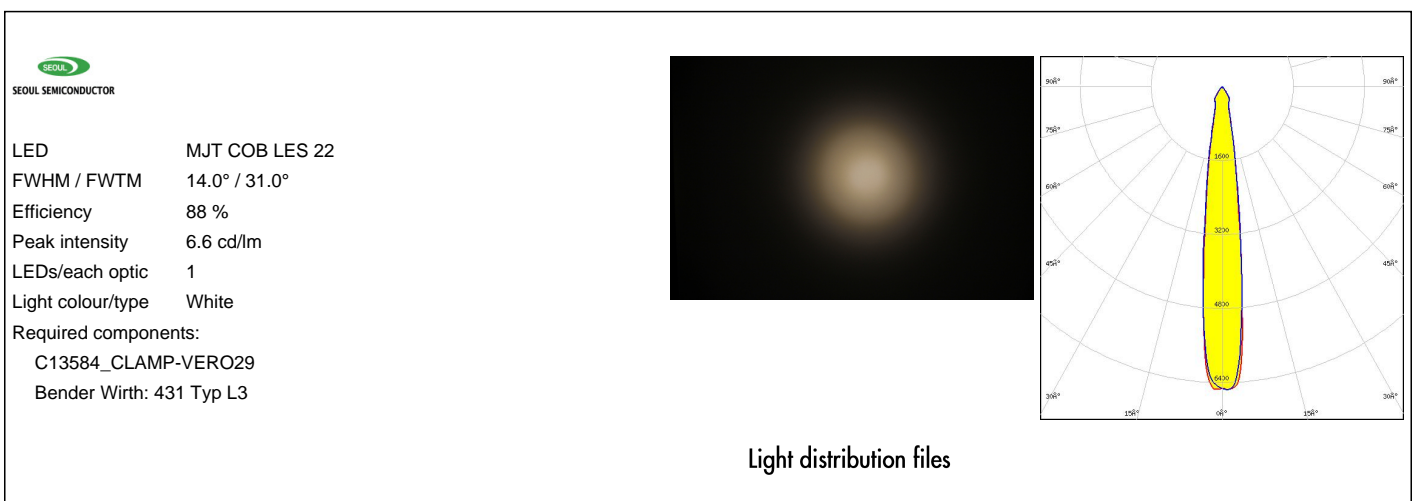
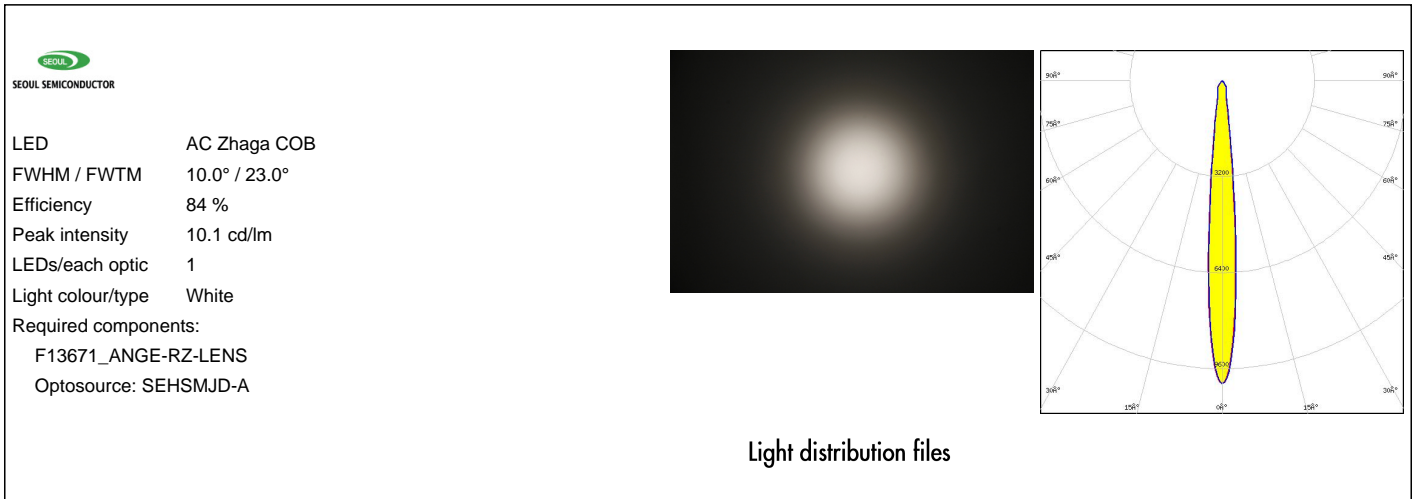

OPTICAL RESULTS (MEASURED):



LED WU-M-461
FWHM / FWTM 9.0° / 17.0°
Efficiency 93 %
Peak intensity 18 cd/lm
LEDs/each optic 1
Light colour/type White
Required components:
 TE Connectivity: OPTIC CLIP Z50 TYPE1 2213194-1

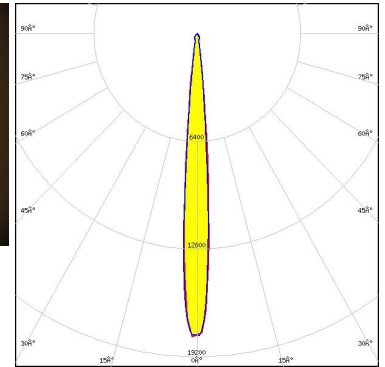

Light distribution files



LED WU-M-462
FWHM / FWTM 13.0° / 25.0°
Efficiency 92 %
Peak intensity 9.7 cd/lm
LEDs/each optic 1
Light colour/type White
Required components:
 TE Connectivity: OPTIC CLIP Z50 TYPE1 2213194-1

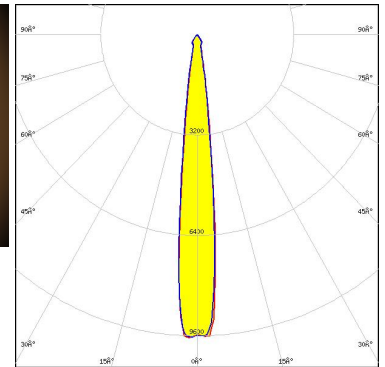

Light distribution files



LED WU-M-464
FWHM / FWTM 12.0° / 24.0°
Efficiency 92 %
Peak intensity 9.9 cd/lm
LEDs/each optic 1
Light colour/type White
Required components:
 TE Connectivity: OPTIC CLIP Z50 TYPE1 2213194-1

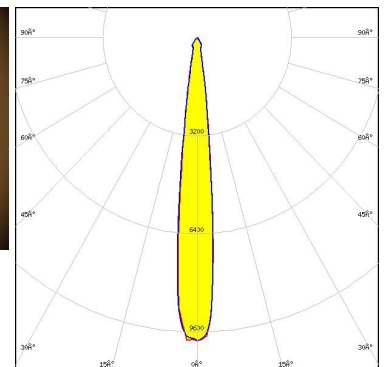

Light distribution files

OPTICAL RESULTS (MEASURED):



LED WU-M-484
FWHM / FWTM 10.0° / 22.0°
Efficiency 84 %
Peak intensity 12 cd/lm
LEDs/each optic 1
Light colour/type White
Required components:
 F13671_ANGE-RZ-LENS
 TE Connectivity: OPTIC CLIP Z50 TYPE1 2213194-1

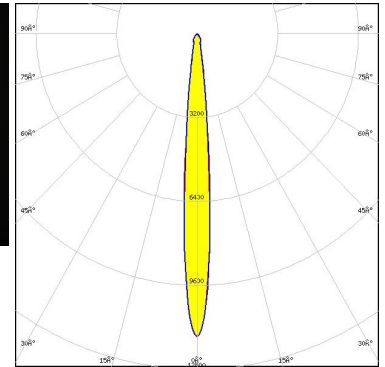

Light distribution files



LED WU-M-484
FWHM / FWTM 9.0° / 17.0°
Efficiency 93 %
Peak intensity 17.9 cd/lm
LEDs/each optic 1
Light colour/type White
Required components:
 TE Connectivity: OPTIC CLIP Z50 TYPE1 2213194-1

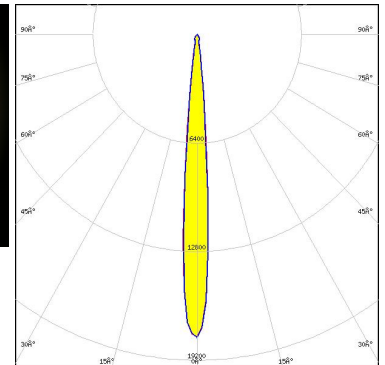
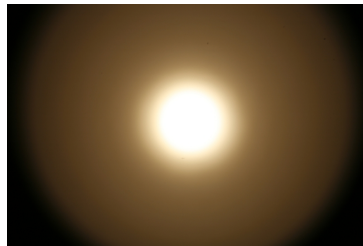

Light distribution files



LED WU-M-485
FWHM / FWTM 13.0° / 25.0°
Efficiency 93 %
Peak intensity 9.5 cd/lm
LEDs/each optic 1
Light colour/type White
Required components:
 TE Connectivity: OPTIC CLIP Z50 TYPE1 2213194-1

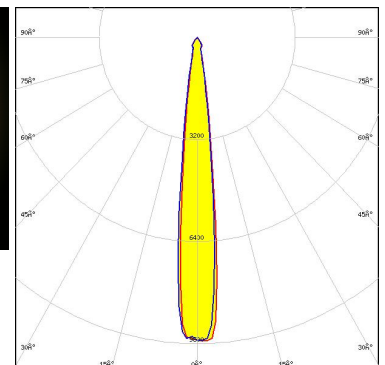

Light distribution files

OPTICAL RESULTS (MEASURED):



LED WU-M-486
FWHM / FWTM 13.0° / 25.0°
Efficiency 93 %
Peak intensity 9.6 cd/lm
LEDs/each optic 1
Light colour/type White
Required components:
TE Connectivity: OPTIC CLIP Z50 TYPE1 2213194-1

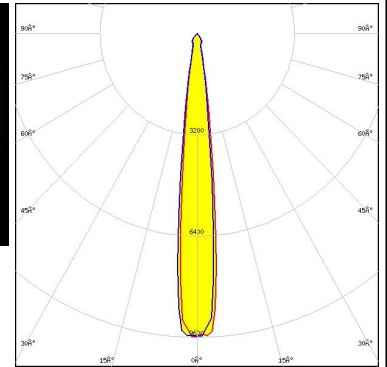
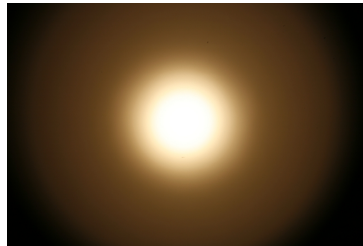

Light distribution files

OPTICAL RESULTS (SIMULATED):



LED V10 Gen7
FWHM / FWTM 10.0° / 19.0°
Efficiency 91 %
Peak intensity 15.3 cd/lm
LEDs/each optic 1
Light colour/type White
Required components:
C13658_CLAMP-VERO13-18

Bender Wirth: 434 Typ L1

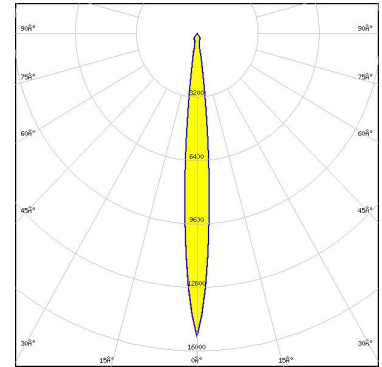

Light distribution files



LED V13 Gen7
FWHM / FWTM 11.0° / 22.0°
Efficiency 90 %
Peak intensity 11.5 cd/lm
LEDs/each optic 1
Light colour/type White
Required components:

IDEAL: 50-2103CT + 50-2100AN

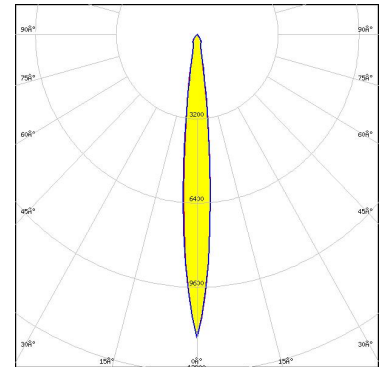

Light distribution files



LED V22 Gen7
FWHM / FWTM 12.0° / 30.0°
Efficiency 93 %
Peak intensity 8.3 cd/lm
LEDs/each optic 1
Light colour/type White
Required components:

IDEAL: 50-2204-CT + 50-2100AN

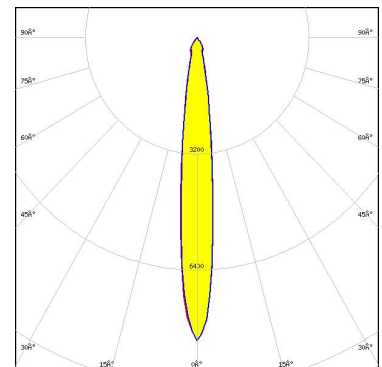

Light distribution files

OPTICAL RESULTS (SIMULATED):



LED CXA/B 1830
 FWHM / FWTM 12.0° / 24.0°
 Efficiency 88 %
 Peak intensity 10.2 cd/lm
 LEDs/each optic 1
 Light colour/type White

Required components:

TE Connectivity: 2213401-2 + OPTIC CLIP Z50 TYPE1 2213194-1

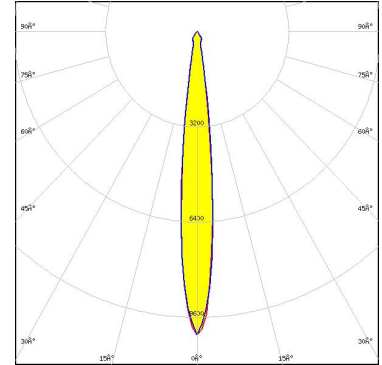

Light distribution files



LED LUXEON CoB 1204/1205
 FWHM / FWTM 10.0° / 16.0°
 Efficiency 92 %
 Peak intensity 20.7 cd/lm
 LEDs/each optic 1
 Light colour/type White

Required components:

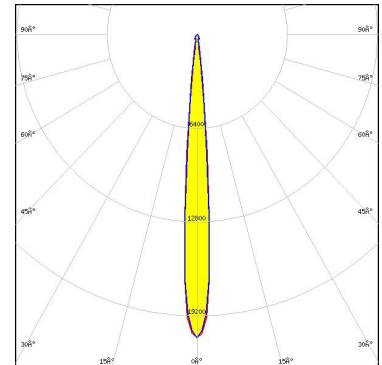

Light distribution files



LED CxM-14 (19x19)
 FWHM / FWTM 10.0° / 18.0°
 Efficiency 88 %
 Peak intensity 15 cd/lm
 LEDs/each optic 1
 Light colour/type White

Required components:

C13658_CLAMP-VERO13-18

Bender Wirth: 486 Typ L1

Light distribution files

OPTICAL RESULTS (SIMULATED):



LED CxM-9 (13.5x13.5)
FWHM / FWTM 6.0° / 12.0°
Efficiency 90 %
Peak intensity 34.1 cd/lm
LEDs/each optic 1
Light colour/type White

Required components:

C13658_CLAMP-VERO13-18

Bender Wirth: 434 Typ L1

Light distribution files



Opto Semiconductors

LED Soleriq S15
FWHM / FWTM 10.0° / 19.0°
Efficiency 90 %
Peak intensity 14.3 cd/lm
LEDs/each optic 1
Light colour/type White

Required components:

TE Connectivity: 2213254-2 + OPTIC CLIP Z50 TYPE1 2213194-1

Light distribution files

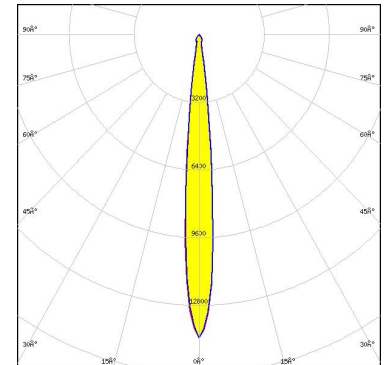

LED ZC12/18
FWHM / FWTM 10.0° / 18.0°
Efficiency 88 %
Peak intensity 15 cd/lm
LEDs/each optic 1
Light colour/type White

Required components:

C13658_CLAMP-VERO13-18

Bender Wirth: 433 Typ L1

OPTICAL RESULTS (SIMULATED):

| | |
|---|--------------|
|  SEUL SEMICONDUCTOR | |
| LED | ZC4/6 |
| FWHM / FWTM | 6.0° / 12.0° |
| Efficiency | 90 % |
| Peak intensity | 34.1 cd/m |
| LEDs/each optic | 1 |
| Light colour/type | White |
| Required components: C13658_CLAMP-VERO13-18 | |
| Bender Wirth: 434 Typ L1 | |

| | |
|--|---------------|
|  | |
| LED | SLE G7 LES13 |
| FWHM / FWTM | 12.0° / 22.0° |
| Efficiency | 94 % |
| Peak intensity | 12.5 cd/m |
| LEDs/each optic | 1 |
| Light colour/type | White |
| Required components: | |
| Bender Wirth: 633c 3Hook | |

Light distribution files

GENERAL INFORMATION:

NOTE: The typical beam angle will be changed by different color, chip size and chip position tolerance. The typical total beam angle is the full angle measured where the luminous intensity is half of the peak value.

Due to use of high power COB's with this product, special attention to proper thermal design is highly recommended. LEDiL has no liability for direct, indirect or consecutive damages arising from the LEDiL products being used outside of the recommended temperature range.

MATERIALS:

As part of our continuous research and improvement processes, and to ensure the best possible quality and availability of our products, LEDiL reserves the right to change material grades without notice.

PRODUCT DATA USER AGREEMENT AND DISCLAIMER:

The measured data in the provided downloadable LEDiL Product Datasheets and Mechanical 2D-Drawings is rounded and provided as reference for planning. LEDiL Oy's optical specifications have been verified by conducting performance testing of the products in accordance with the company's quality system. The reported data are averaged results of multiple measurements with typical variation. LEDiL Oy reserves the right to without prior notification make changes and improvements to its products.

LEDiL Oy assumes neither warranty, nor guarantee nor any other liability of any kind for the contents and correctness of the provided data. The provided data has been generated with highest diligence but the provided data may in reality not represent the complete possible variation range of all intrinsic parameters. Therefore, in certain cases a deviation from the provided data could occur.

LEDiL Oy reserves the right to undertake technical changes of its products without further notification which could lead to changes in the provided data. LEDiL Oy assumes no liability of any kind for the possible deviation from any provided data or any other damage resulting from the usage of the provided data.

The user agrees to this disclaimer and user agreement with the download or usage of the provided files.

LEDiL Oy

Joensuunkatu 7
FI-24240 SALO
Finland

LEDiL Inc.

228 West Page Street
Suite D
Sycamore IL 60178
USA

Ledil Optics Technology (Shenzhen) Co., Ltd.

405 , Block B
Casic Motor Building
Shenzhen 518057
P.R.CHINA

Local sales and technical support

[www.ledil.com/
where_to_buy](http://www.ledil.com/where_to_buy)

Shipping locations

Poznan, Poland
Hong Kong, China

Distribution Partners

[www.ledil.com/
where_to_buy](http://www.ledil.com/where_to_buy)