

## ANGELINA-S

~20° spot beam

### SPECIFICATION:

Dimensions	Ø 82.0
Height	31 mm
Fastening	socket
ROHS compliant	yes ⓘ

### MATERIALS:

Component	Type	Material	Colour	Finish	Coating
ANGELINA-S	Reflector	PC	metal		HMDS

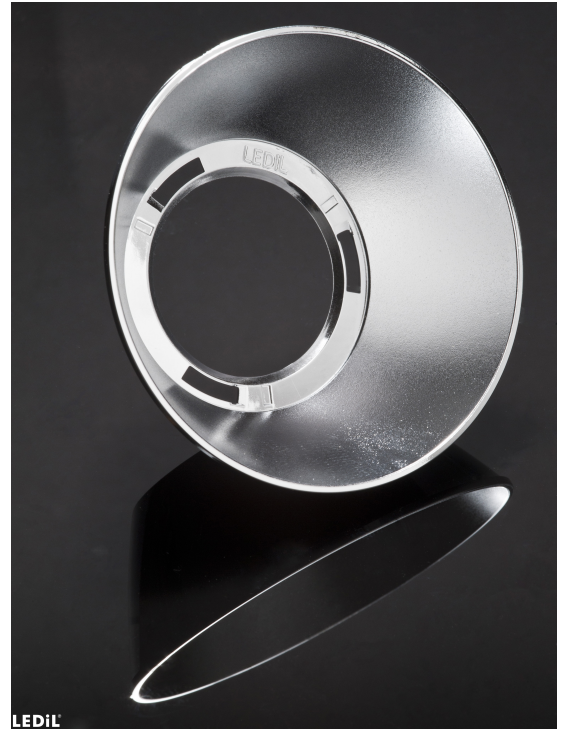

### ORDERING INFORMATION:

Component	Qty in box	MOQ	MPQ	Box weight (kg)
F13325_ANGELINA-S » Box size: 480 x 280 x 300 mm	900	120	60	12.7

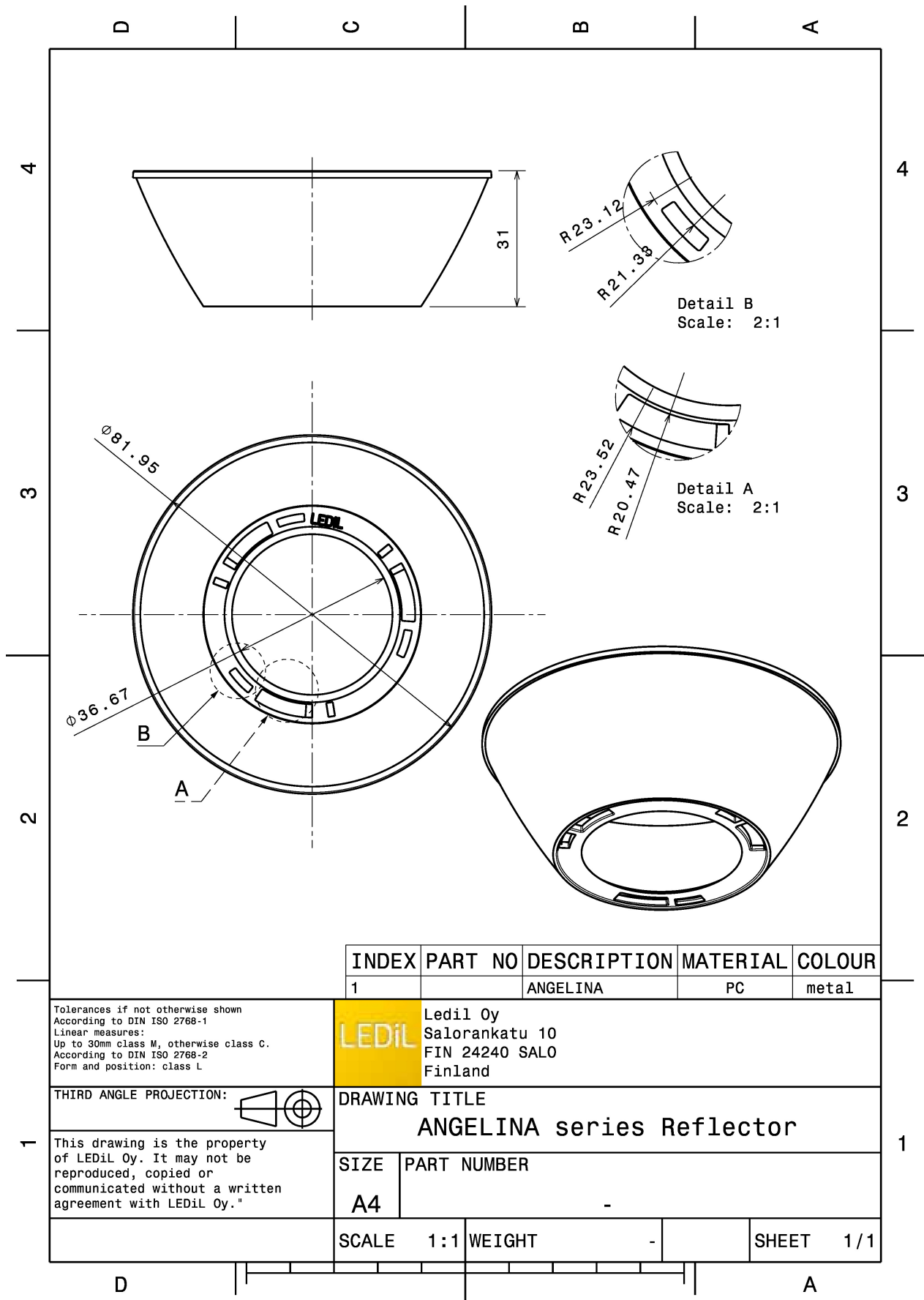

INDEX	PART NO	DESCRIPTION	MATERIAL	COLOUR
1		ANGELINA	PC	metal

Tolerances if not otherwise shown  
According to DIN ISO 2768-1  
Linear measures:  
Up to 30mm class M, otherwise class C.  
According to DIN ISO 2768-2  
Form and position: class L

**LEDiL** Ledil Oy  
Salorankatu 10  
FIN 24240 SALO  
Finland

THIRD ANGLE PROJECTION:

DRAWING TITLE  
**ANGELINA series Reflector**

This drawing is the property of LEDiL Oy. It may not be reproduced, copied or communicated without a written agreement with LEDiL Oy."

SIZE	PART NUMBER
A4	-

SCALE	1:1	WEIGHT	-	SHEET	1/1
-------	-----	--------	---	-------	-----

See also our general installation guide: [www.ledil.com/installation\\_guide](http://www.ledil.com/installation_guide)

### OPTICAL RESULTS (MEASURED):

bridgelux

LED BXRA ES Rectangle  
 FWHM / FWTM 17.0° / 75.0°  
 Efficiency 94 %  
 Peak intensity 3 cd/lm  
 LEDs/each optic 1  
 Light colour/type White  
 Required components:  
 IDEAL: 50-2100BL + 50-2100AN

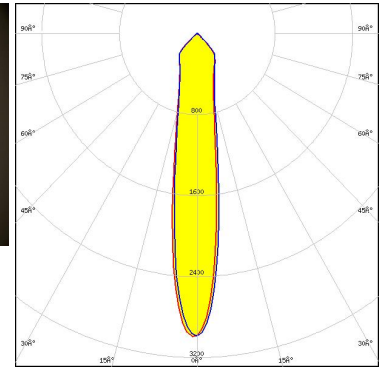
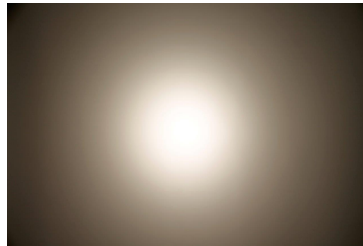

Light distribution files

bridgelux

LED V10 Gen7  
 FWHM / FWTM 22.0° / 92.0°  
 Efficiency 88 %  
 Peak intensity 2 cd/lm  
 LEDs/each optic 1  
 Light colour/type White  
 Required components:  
 C13658\_CLAMP-VERO13-18  
 F13671\_ANGE-RZ-LENS  
 Bender Wirth: 434 Typ L1

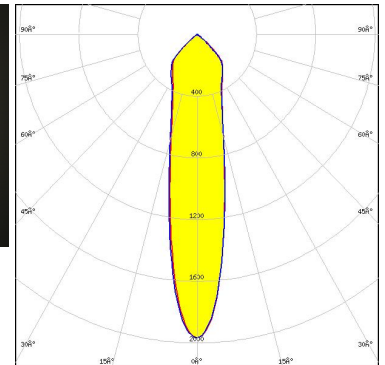
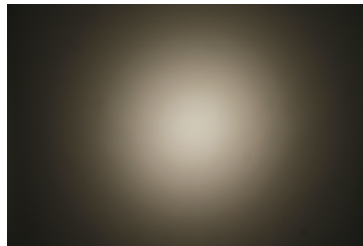

Light distribution files

bridgelux

LED V13 Gen7  
 FWHM / FWTM 20.0° / 87.0°  
 Efficiency 94 %  
 Peak intensity 2.6 cd/lm  
 LEDs/each optic 1  
 Light colour/type White  
 Required components:  
 TE Connectivity: 2213254-2 + OPTIC CLIP Z50 TYPE1 2213194-1

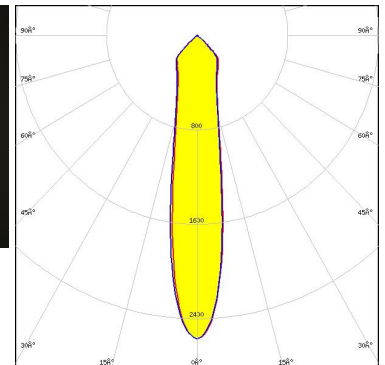
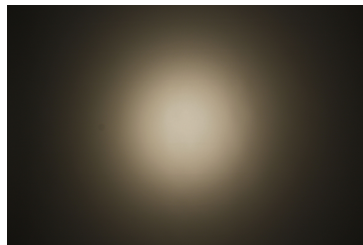

Light distribution files

### OPTICAL RESULTS (MEASURED):



**LED** V15 Gen6  
**FWHM / FWTM** 23.0° / 94.0°  
**Efficiency** 88 %  
**Peak intensity** 2.4 cd/lm  
**LEDs/each optic** 1  
**Light colour/type** White  
**Required components:**  
 C13658\_CLAMP-VERO13-18  
 Bender Wirth: 456 Typ L2

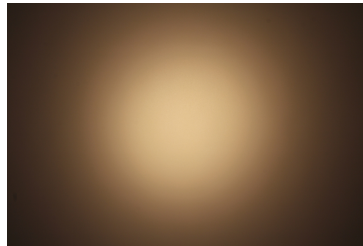

Light distribution files



**LED** V22 Gen6  
**FWHM / FWTM** 29.0° / 91.0°  
**Efficiency** 92 %  
**Peak intensity** 1.6 cd/lm  
**LEDs/each optic** 1  
**Light colour/type** White  
**Required components:**  
 IDEAL: 50-2204-CT + 50-2100AN

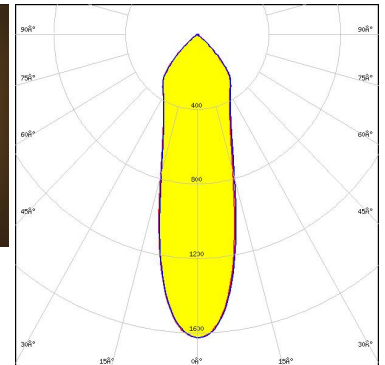
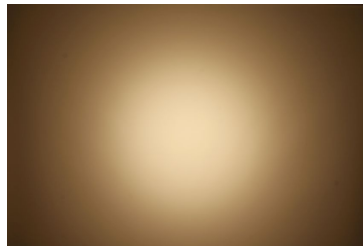

Light distribution files



**LED** V22 Gen6  
**FWHM / FWTM** 32.0° / 93.0°  
**Efficiency** 88 %  
**Peak intensity** 1.4 cd/lm  
**LEDs/each optic** 1  
**Light colour/type** White  
**Required components:**  
 F13671\_ANGE-RZ-LENS  
 IDEAL: 50-2204-CT + 50-2100AN

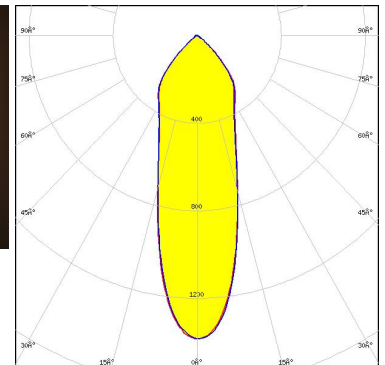
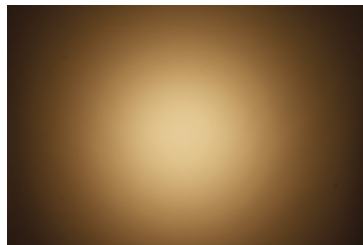

Light distribution files

### OPTICAL RESULTS (MEASURED):



**LED** Vero SE 13  
**FWHM / FWTM** 20.0° / 89.0°  
**Efficiency** 94 %  
**Peak intensity** 2.5 cd/lm  
**LEDs/each optic** 1  
**Light colour/type** White  
**Required components:**  
 C16402\_CLAMP-VEROSE-13-18

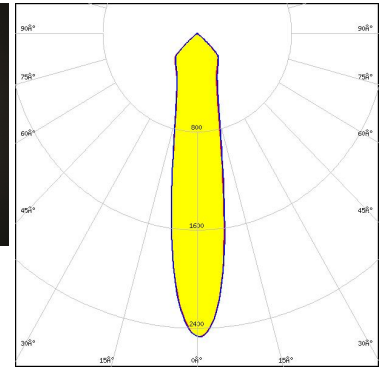
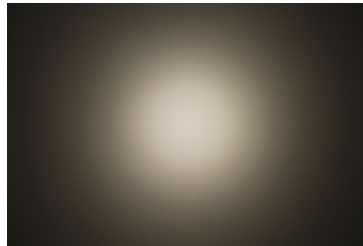

Light distribution files



**LED** Vero SE 18  
**FWHM / FWTM** 26.0° / 91.0°  
**Efficiency** 94 %  
**Peak intensity** 2 cd/lm  
**LEDs/each optic** 1  
**Light colour/type** White  
**Required components:**  
 C16402\_CLAMP-VEROSE-13-18

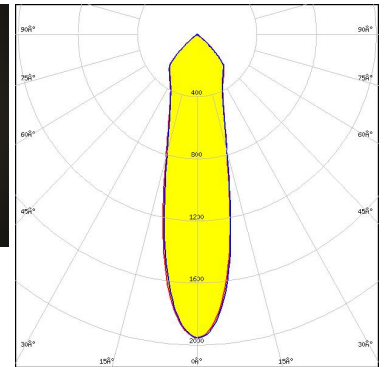
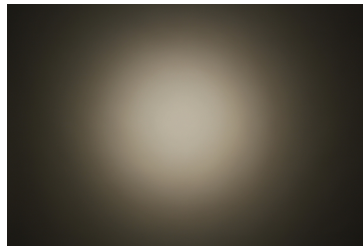

Light distribution files



**LED** VERO13  
**FWHM / FWTM** 25.0° / 92.0°  
**Efficiency** 88 %  
**Peak intensity** 1.8 cd/lm  
**LEDs/each optic** 1  
**Light colour/type** White  
**Required components:**  
 C13658\_CLAMP-VERO13-18  
 F13671\_ANGE-RZ-LENS

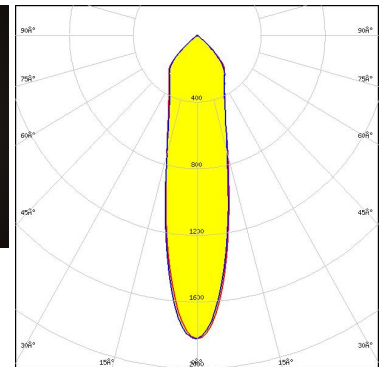
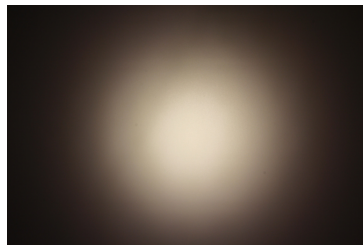

Light distribution files

### OPTICAL RESULTS (MEASURED):



**LED** VERO13  
**FWHM / FWTM** 20.0° / 68.0°  
**Efficiency** 93 %  
**Peak intensity** 3 cd/m  
**LEDs/each optic** 1  
**Light colour/type** White  
**Required components:**  
 C13658\_CLAMP-VERO13-18

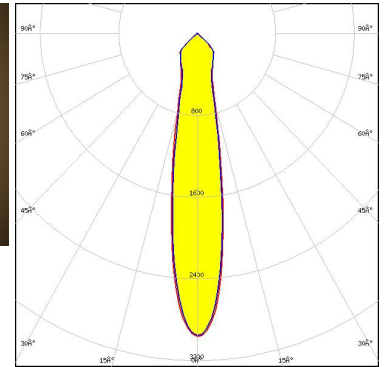

Light distribution files



**LED** VERO18  
**FWHM / FWTM** 29.0° / 94.0°  
**Efficiency** 89 %  
**Peak intensity** 1.5 cd/m  
**LEDs/each optic** 1  
**Light colour/type** White  
**Required components:**  
 C13658\_CLAMP-VERO13-18  
 F13671\_ANGE-RZ-LENS

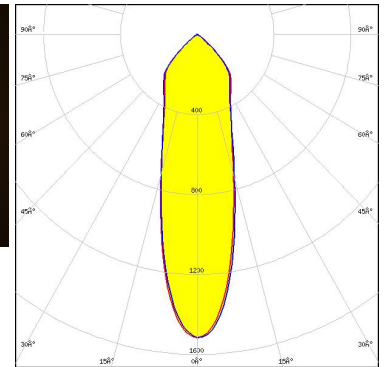
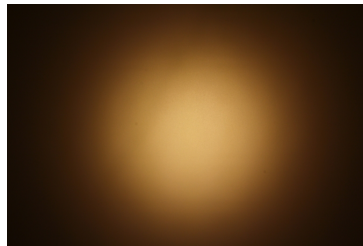

Light distribution files



**LED** VERO18  
**FWHM / FWTM** 25.0° / 88.0°  
**Efficiency** 92 %  
**Peak intensity** 2.2 cd/m  
**LEDs/each optic** 1  
**Light colour/type** White  
**Required components:**  
 C13658\_CLAMP-VERO13-18

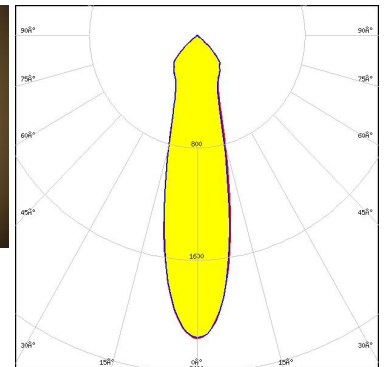

Light distribution files

### OPTICAL RESULTS (MEASURED):

bridgelux

LED VERO29  
 FWHM / FWTM 44.0° / 99.0°  
 Efficiency 89 %  
 Peak intensity 1 cd/lm  
 LEDs/each optic 1  
 Light colour/type White  
 Required components:  
 C13584\_CLAMP-VERO29  
 F13671\_ANGE-RZ-LENS

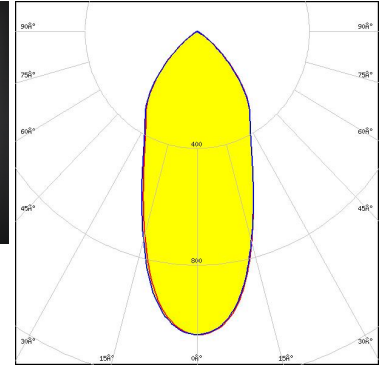

Light distribution files

bridgelux

LED VERO29  
 FWHM / FWTM 39.0° / 96.0°  
 Efficiency 90 %  
 Peak intensity 1.2 cd/lm  
 LEDs/each optic 1  
 Light colour/type White  
 Required components:  
 C13584\_CLAMP-VERO29

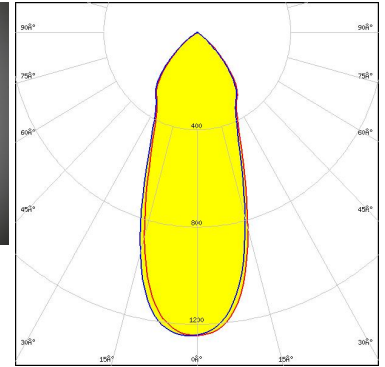

Light distribution files

bridgelux

LED Vesta TW 15mm DP  
 FWHM / FWTM 24.0° / 90.0°  
 Efficiency 92 %  
 Peak intensity 2.1 cd/lm  
 LEDs/each optic 1  
 Light colour/type Tunable White  
 Required components:  
 C13658\_CLAMP-VERO13-18  
 Bender Wirth: 482 Typ L2

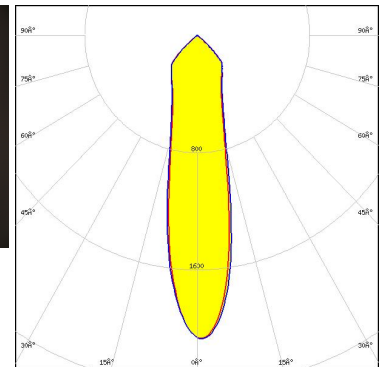
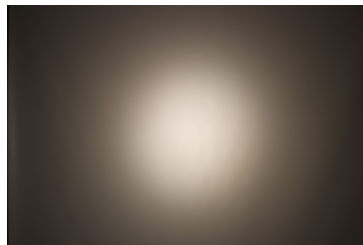

Light distribution files

### OPTICAL RESULTS (MEASURED):



LED Vesta TW 15mm DP  
 FWHM / FWTM 28.0° / 94.0°  
 Efficiency 89 %  
 Peak intensity 1.6 cd/lm  
 LEDs/each optic 1  
 Light colour/type Tunable White

Required components:

C13658\_CLAMP-VERO13-18  
 F13671\_ANGE-RZ-LENS  
 Bender Wirth: 482 Typ L2

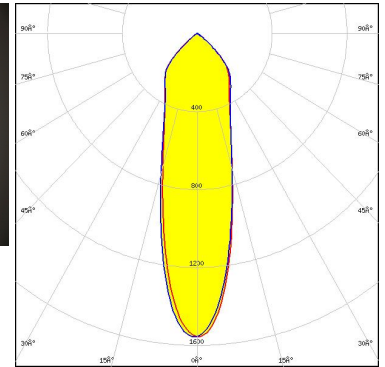
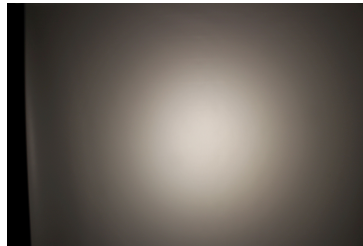

Light distribution files



LED Vesta TW 18mm (31W) DP  
 FWHM / FWTM 27.0° / 92.0°  
 Efficiency 94 %  
 Peak intensity 1.8 cd/lm  
 LEDs/each optic 1  
 Light colour/type Tunable White

Required components:

C13584\_CLAMP-VERO29  
 Bender Wirth: 483 Typ L3

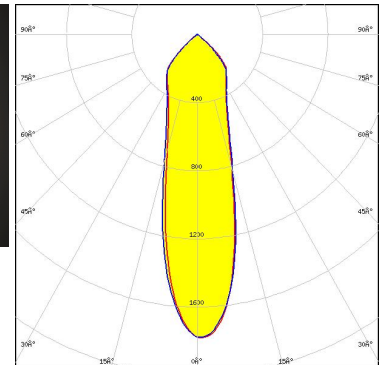
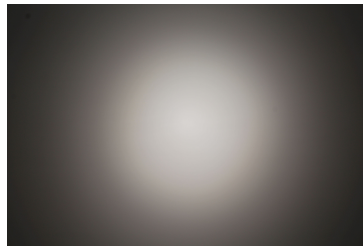

Light distribution files



LED Vesta TW 18mm (31W) DP  
 FWHM / FWTM 30.0° / 94.0°  
 Efficiency 89 %  
 Peak intensity 1.5 cd/lm  
 LEDs/each optic 1  
 Light colour/type Tunable White

Required components:

C13584\_CLAMP-VERO29  
 F13671\_ANGE-RZ-LENS  
 Bender Wirth: 483 Typ L3

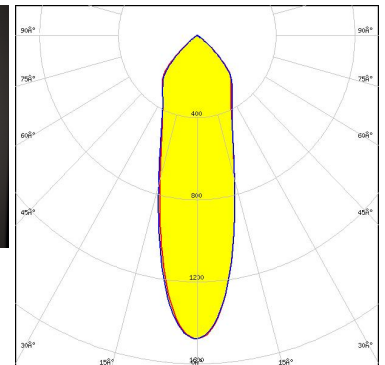
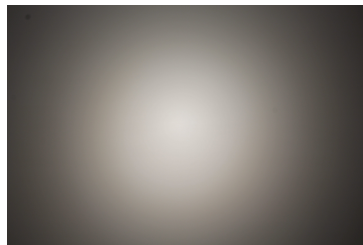

Light distribution files



### OPTICAL RESULTS (MEASURED):



LED Vesta TW 22mm DP  
 FWHM / FWTM 33.0° / 95.0°  
 Efficiency 89 %  
 Peak intensity 1.4 cd/lm  
 LEDs/each optic 1  
 Light colour/type Tunable White

Required components:

C13584\_CLAMP-VERO29  
 F13671\_ANGE-RZ-LENS  
 Bender Wirth: 494 Typ L3

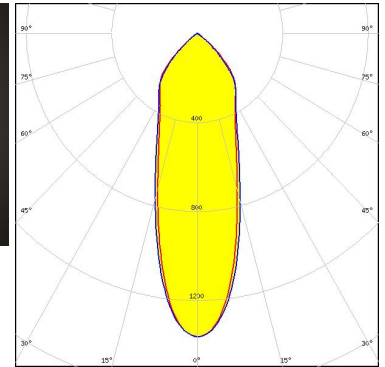
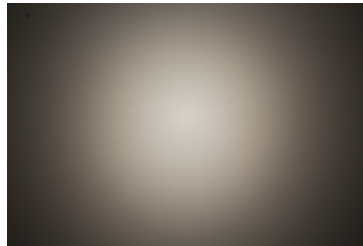

Light distribution files



LED Vesta TW 22mm DP  
 FWHM / FWTM 30.0° / 93.0°  
 Efficiency 94 %  
 Peak intensity 1.6 cd/lm  
 LEDs/each optic 1  
 Light colour/type Tunable White

Required components:

C13584\_CLAMP-VERO29  
 Bender Wirth: 494 Typ L3

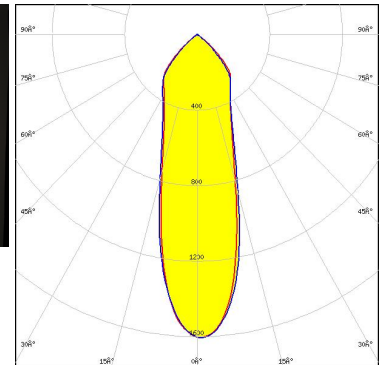
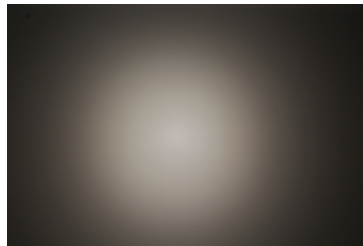

Light distribution files

### CITIZEN

LED CLL02x/CLU02x (LES10)  
 FWHM / FWTM 17.0° / 75.0°  
 Efficiency 93 %  
 Peak intensity 2.9 cd/lm  
 LEDs/each optic 1  
 Light colour/type White

Required components:

C13658\_CLAMP-VERO13-18  
 Bender Wirth: 434 Typ L1

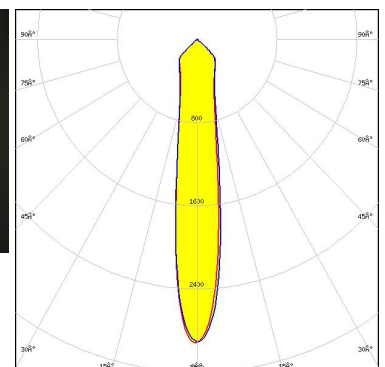
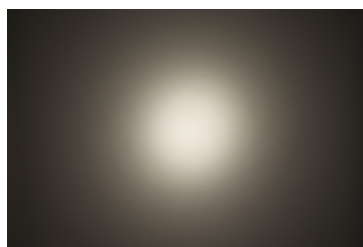

Light distribution files

### OPTICAL RESULTS (MEASURED):

#### CITIZEN

LED CLL03x/CLU03x  
 FWHM / FWTM 22.0° / 87.0°  
 Efficiency 94 %  
 Peak intensity 2.5 cd/lm  
 LEDs/each optic 1  
 Light colour/type White

Required components:

TE Connectivity: 2213254-2 + OPTIC CLIP Z50 TYPE1 2213194-1

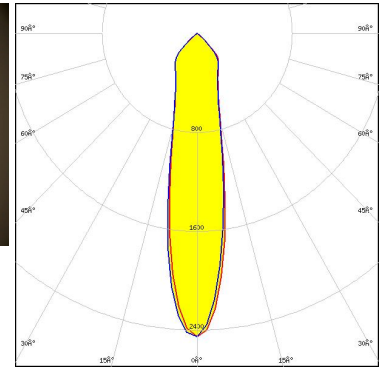
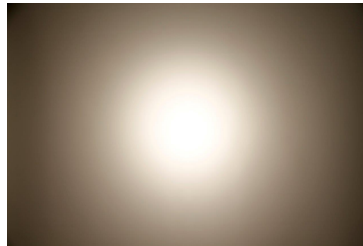

Light distribution files

#### CITIZEN

LED CLL03x/CLU03x  
 FWHM / FWTM 23.0° / 91.0°  
 Efficiency 91 %  
 Peak intensity 1.9 cd/lm  
 LEDs/each optic 1  
 Light colour/type White

Required components:

C16791\_CLAMP-Z45-A  
 F13671\_ANGE-RZ-LENS  
 TE Connectivity: 2325807-3

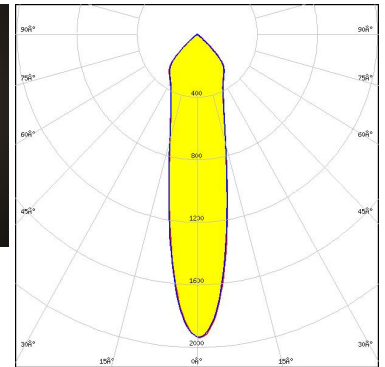
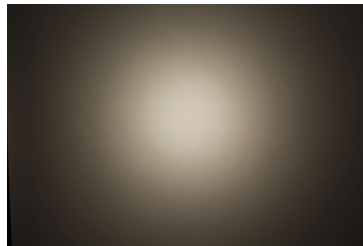

Light distribution files

#### CITIZEN

LED CLL03x/CLU03x  
 FWHM / FWTM 23.0° / 90.0°  
 Efficiency 87 %  
 Peak intensity 1.8 cd/lm  
 LEDs/each optic 1  
 Light colour/type White

Required components:

F13671\_ANGE-RZ-LENS  
 IDEAL: 50-2103CT + 50-2100AN

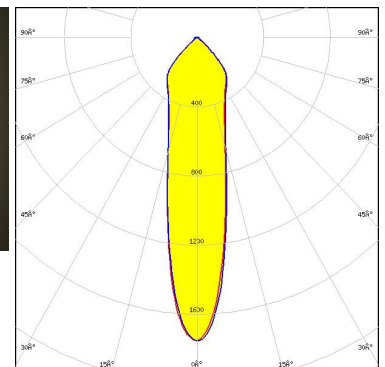
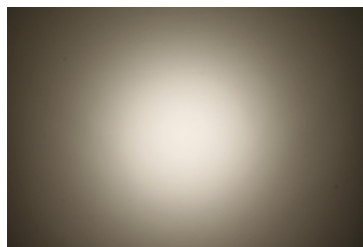

Light distribution files

### OPTICAL RESULTS (MEASURED):

#### CITIZEN

LED CLL03x/CLU03x  
 FWHM / FWTM 19.0° / 83.0°  
 Efficiency 94 %  
 Peak intensity 2.7 cd/lm  
 LEDs/each optic 1  
 Light colour/type White  
 Required components:  
 IDEAL: 50-2103CT + 50-2100AN

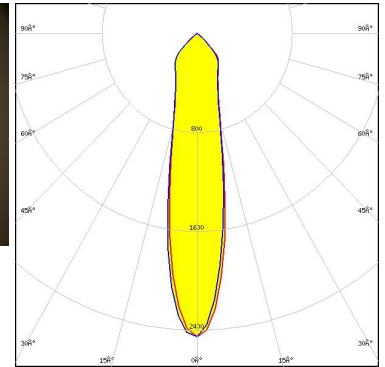
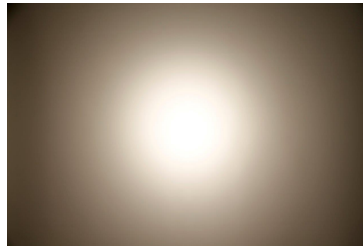

Light distribution files

#### CITIZEN

LED CLL03x/CLU03x  
 FWHM / FWTM 21.0° / 89.0°  
 Efficiency 92 %  
 Peak intensity 2.3 cd/lm  
 LEDs/each optic 1  
 Light colour/type White  
 Required components:  
 C13658\_CLAMP-VERO13-18  
 Bender Wirth: 433 Typ L1

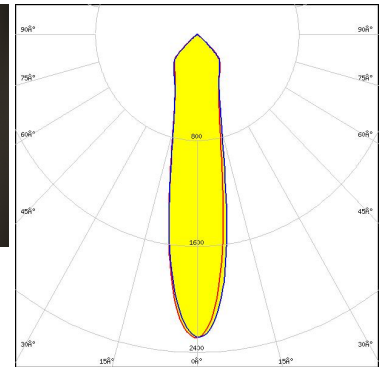

Light distribution files

#### CITIZEN

LED CLL03x/CLU03x  
 FWHM / FWTM 25.0° / 92.0°  
 Efficiency 87 %  
 Peak intensity 1.7 cd/lm  
 LEDs/each optic 1  
 Light colour/type White  
 Required components:  
 F13671\_ANGE-RZ-LENS  
 TE Connectivity: 2213254-2 + OPTIC CLIP Z50 TYPE1 2213194-1

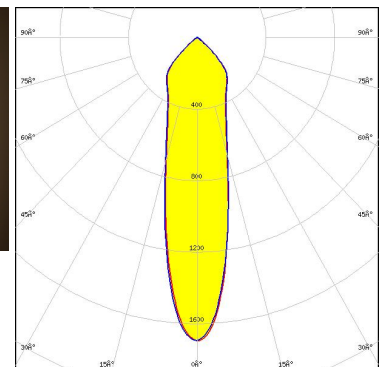
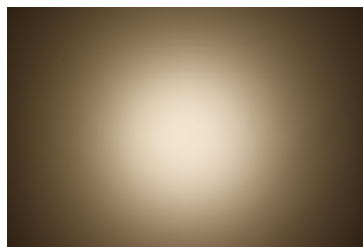

Light distribution files

### OPTICAL RESULTS (MEASURED):

#### CITIZEN

LED CLL03x/CLU03x  
 FWHM / FWTM 20.0° / 88.0°  
 Efficiency 94 %  
 Peak intensity 2.5 cd/lm  
 LEDs/each optic 1  
 Light colour/type White  
 Required components:  
 C16791\_CLAMP-Z45-A  
 TE Connectivity: 2325807-3

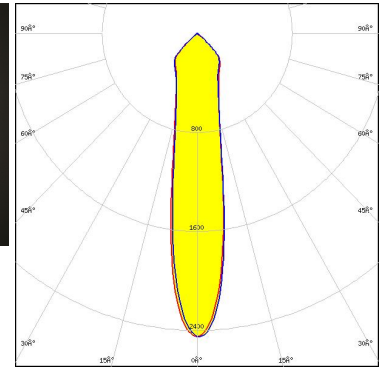
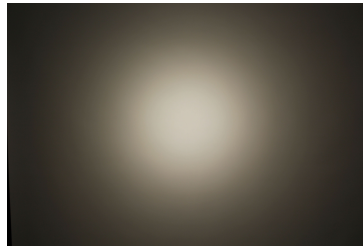

Light distribution files

#### CITIZEN

LED CLL04x/CLU04x  
 FWHM / FWTM 30.0° / 91.0°  
 Efficiency 92 %  
 Peak intensity 1.6 cd/lm  
 LEDs/each optic 1  
 Light colour/type White  
 Required components:  
 IDEAL: 50-2204-CT + 50-2100AN

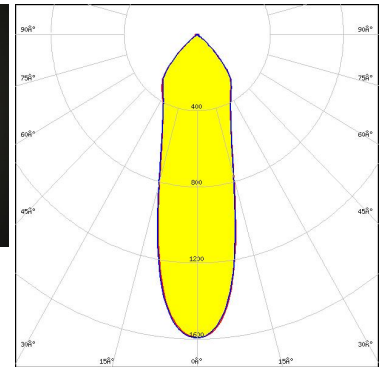
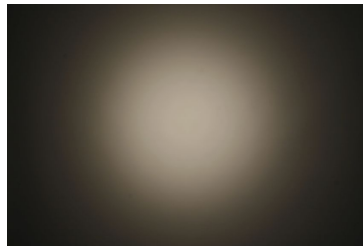

Light distribution files

#### CITIZEN

LED CLL04x/CLU04x  
 FWHM / FWTM 33.0° / 93.0°  
 Efficiency 88 %  
 Peak intensity 1.3 cd/lm  
 LEDs/each optic 1  
 Light colour/type White  
 Required components:  
 F13671\_ANGE-RZ-LENS  
 IDEAL: 50-2204-CT + 50-2100AN

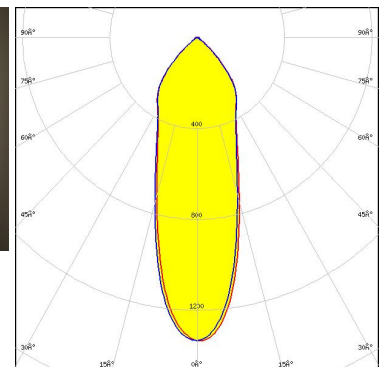
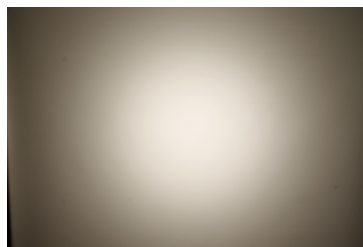

Light distribution files

### OPTICAL RESULTS (MEASURED):

#### CITIZEN

LED CLL04x/CLU04x  
 FWHM / FWTM 29.0° / 91.0°  
 Efficiency 93 %  
 Peak intensity 1.7 cd/lm  
 LEDs/each optic 1  
 Light colour/type White  
 Required components:  
 C13584\_CLAMP-VERO29  
 Bender Wirth: 431 Typ L3

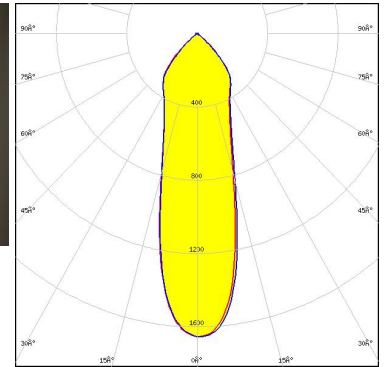
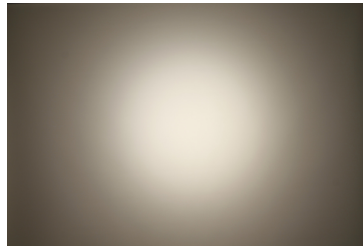

Light distribution files

#### CITIZEN

LED CLU700/701/702/703  
 FWHM / FWTM 14.0° / 56.0°  
 Efficiency 93 %  
 Peak intensity 3.7 cd/lm  
 LEDs/each optic 1  
 Light colour/type White  
 Required components:  
 C13658\_CLAMP-VERO13-18  
 Bender Wirth: 434 Typ L1

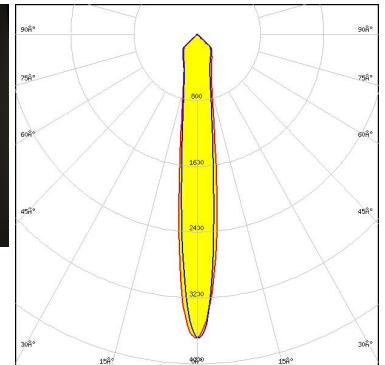

Light distribution files

#### CITIZEN

LED CLU720/721/723  
 FWHM / FWTM 15.0° / 75.0°  
 Efficiency 94 %  
 Peak intensity 3.1 cd/lm  
 LEDs/each optic 1  
 Light colour/type White  
 Required components:  
 IDEAL: 50-2103CT + 50-2100AN

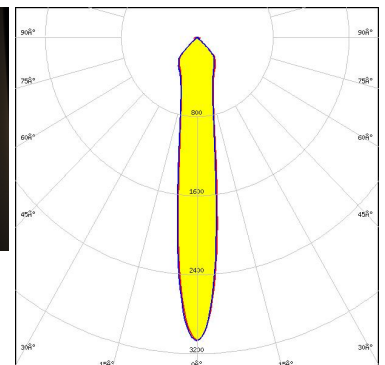
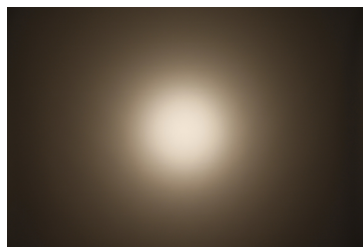

Light distribution files

### OPTICAL RESULTS (MEASURED):

#### CITIZEN

LED CLU720/721/723

FWHM / FWTM 17.0° / 84.0°

Efficiency 94 %

Peak intensity 2.7 cd/lm

LEDs/each optic 1

Light colour/type White

Required components:

TE Connectivity: 2213254-2 + OPTIC CLIP Z50 TYPE1 2213194-1

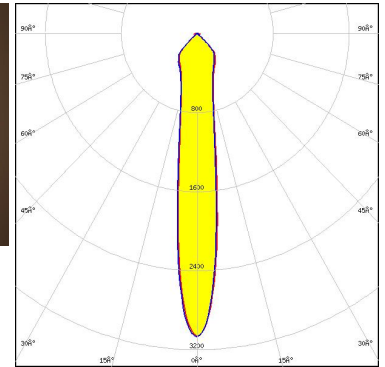
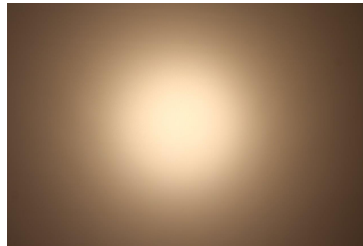

Light distribution files

#### CITIZEN

LED CLU720/721/723

FWHM / FWTM 18.0° / 81.0°

Efficiency 92 %

Peak intensity 2.7 cd/lm

LEDs/each optic 1

Light colour/type White

Required components:

C13658\_CLAMP-VERO13-18

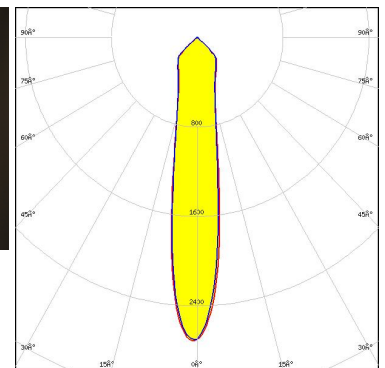
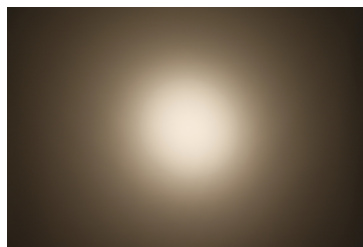

Light distribution files

#### CITIZEN

LED CLU730/731/733

FWHM / FWTM 18.0° / 84.0°

Efficiency 92 %

Peak intensity 2.7 cd/lm

LEDs/each optic 1

Light colour/type White

Required components:

IDEAL: 50-2204-CT + 50-2100AN

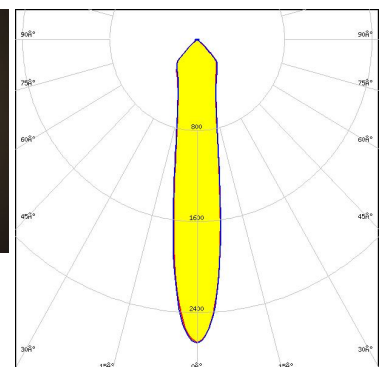
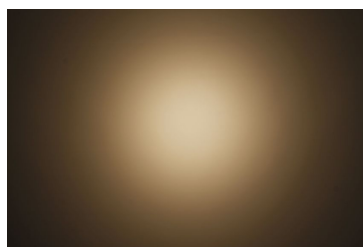

Light distribution files

### OPTICAL RESULTS (MEASURED):

#### CITIZEN

LED CLU730/731/733  
 FWHM / FWTM 18.0° / 84.0°  
 Efficiency 92 %  
 Peak intensity 2.7 cd/lm  
 LEDs/each optic 1  
 Light colour/type White  
 Required components:  
 IDEAL: 50-2204-CT + 50-2100AN

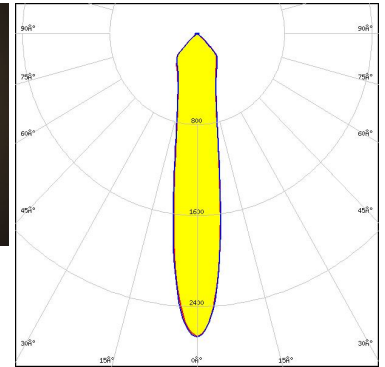
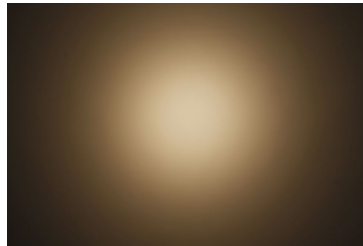

Light distribution files

#### CITIZEN

LED CLU730/731/733  
 FWHM / FWTM 21.0° / 88.0°  
 Efficiency 87 %  
 Peak intensity 2.1 cd/lm  
 LEDs/each optic 1  
 Light colour/type White  
 Required components:  
 F13671\_ANGE-RZ-LENS  
 IDEAL: 50-2204-CT + 50-2100AN

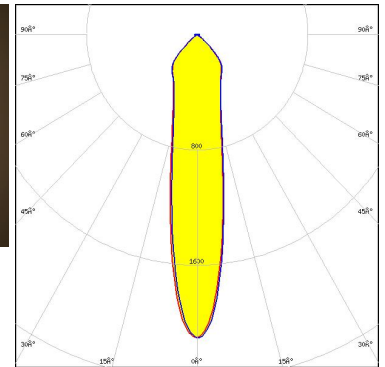
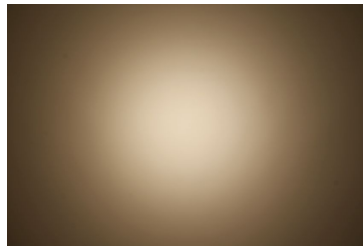

Light distribution files



LED CMA1840  
 FWHM / FWTM 22.0° / 88.0°  
 Efficiency 95 %  
 Peak intensity 2.5 cd/lm  
 LEDs/each optic 1  
 Light colour/type White  
 Required components:  
 C14123\_CLAMP-CXA15-18

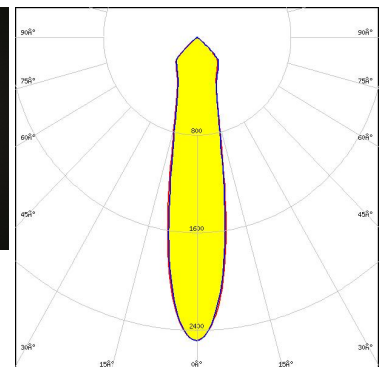
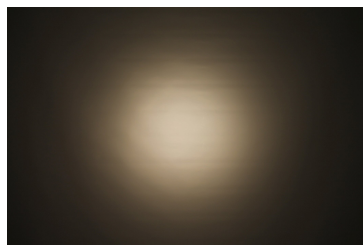

Light distribution files

### OPTICAL RESULTS (MEASURED):



**LED** CMA2550  
**FWHM / FWTM** 26.0° / 90.0°  
**Efficiency** 94 %  
**Peak intensity** 2 cd/lm  
**LEDs/each optic** 1  
**Light colour/type** White  
**Required components:**  
 C14036\_CLAMP\_CXA25-30

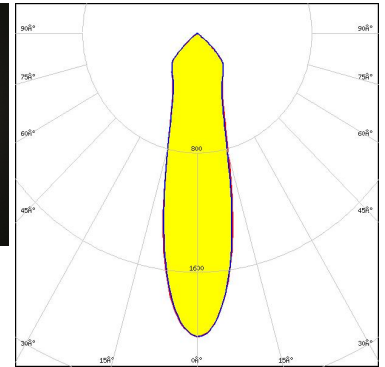
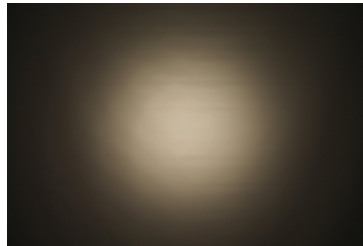

Light distribution files



**LED** CMA3090  
**FWHM / FWTM** 30.0° / 92.0°  
**Efficiency** 94 %  
**Peak intensity** 1.7 cd/lm  
**LEDs/each optic** 1  
**Light colour/type** White  
**Required components:**  
 C14036\_CLAMP\_CXA25-30

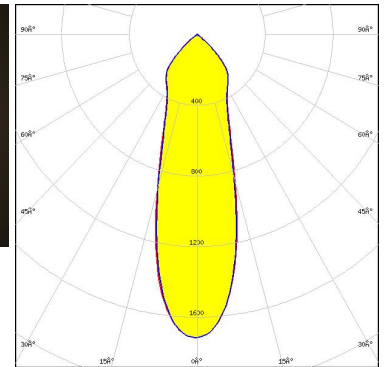
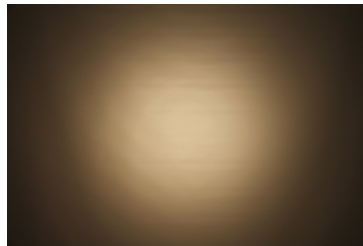

Light distribution files



**LED** CMT14xx  
**FWHM / FWTM** 17.0° / 65.0°  
**Efficiency** 94 %  
**Peak intensity** 3.2 cd/lm  
**LEDs/each optic** 1  
**Light colour/type** White  
**Required components:**  
 C13658\_CLAMP-VERO13-18  
 Bender Wirth: 434 Typ L1

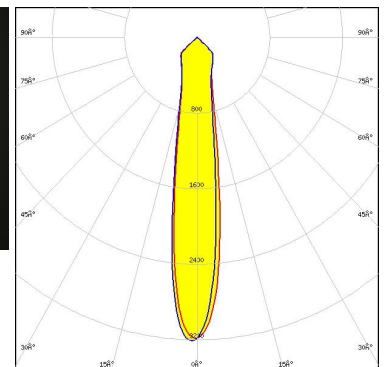
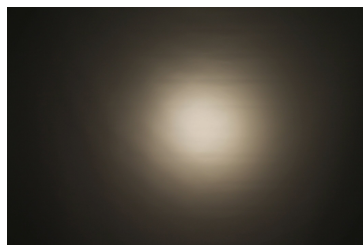

Light distribution files



### OPTICAL RESULTS (MEASURED):



**LED** CMT19xx  
**FWHM / FWTM** 21.0° / 85.0°  
**Efficiency** 94 %  
**Peak intensity** 2.6 cd/lm  
**LEDs/each optic** 1  
**Light colour/type** White  
**Required components:**  
 C13658\_CLAMP-VERO13-18  
 Bender Wirth: 477 Typ L1

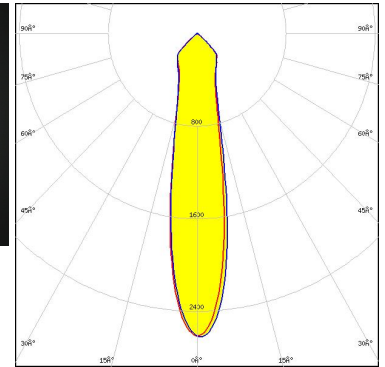
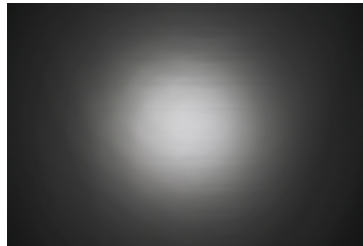

Light distribution files



**LED** CMT28xx  
**FWHM / FWTM** 29.0° / 91.0°  
**Efficiency** 94 %  
**Peak intensity** 1.8 cd/lm  
**LEDs/each optic** 1  
**Light colour/type** White  
**Required components:**  
 C13584\_CLAMP-VERO29  
 Bender Wirth: 471 Typ L3

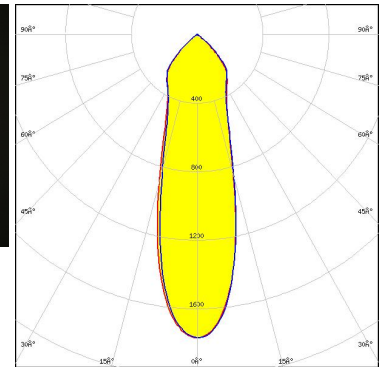
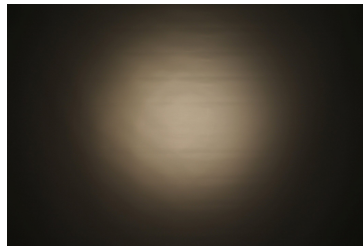

Light distribution files



**LED** CXA/B 15xx  
**FWHM / FWTM** 15.0° / 65.0°  
**Efficiency** 93 %  
**Peak intensity** 3.3 cd/lm  
**LEDs/each optic** 1  
**Light colour/type** White  
**Required components:**  
 C13658\_CLAMP-VERO13-18  
 Bender Wirth: 441 Typ L1

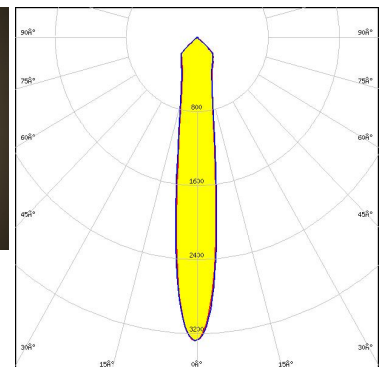
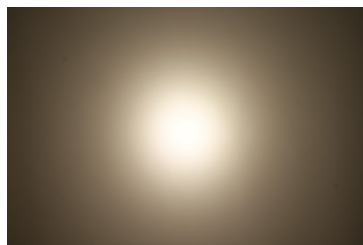

Light distribution files

#### OPTICAL RESULTS (MEASURED):



LED CXA/B 15xx  
 FWHM / FWTM 20.0° / 81.0°  
 Efficiency 94 %  
 Peak intensity 2.8 cd/lm  
 LEDs/each optic 1  
 Light colour/type White  
 Required components:  
 C14123\_CLAMP-CXA15-18

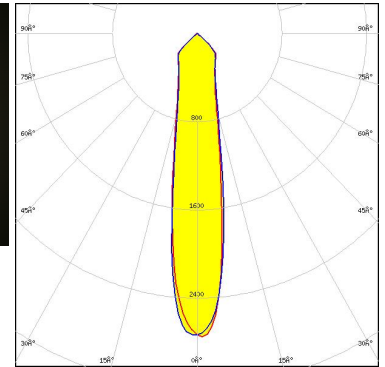

Light distribution files



LED CXA/B 1816 & CXA/B 1820 & CXA 1850  
 FWHM / FWTM 22.0° / 89.0°  
 Efficiency 94 %  
 Peak intensity 2.4 cd/lm  
 LEDs/each optic 1  
 Light colour/type White  
 Required components:  
 C14123\_CLAMP-CXA15-18

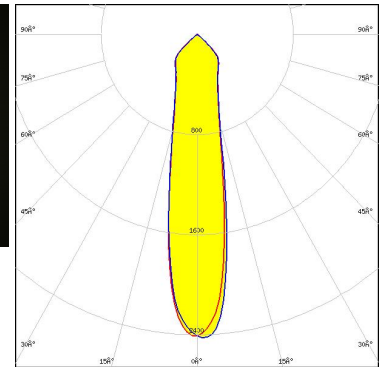

Light distribution files



LED CXA/B 1816 & CXA/B 1820 & CXA 1850  
 FWHM / FWTM 19.0° / 83.0°  
 Efficiency 93 %  
 Peak intensity 2.7 cd/lm  
 LEDs/each optic 1  
 Light colour/type White  
 Required components:  
 TE Connectivity: 2213401-2 + OPTIC CLIP Z50 TYPE1 2213194-1

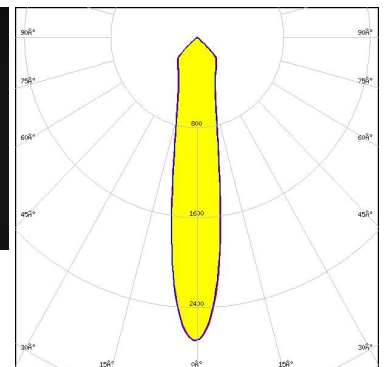
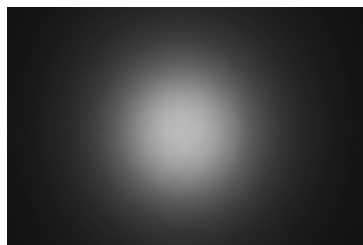

Light distribution files

### OPTICAL RESULTS (MEASURED):



LED CXA/B 1816 & CXA/B 1820 & CXA 1850  
 FWHM / FWTM 19.0° / 87.0°  
 Efficiency 93 %  
 Peak intensity 2.5 cd/lm  
 LEDs/each optic 1  
 Light colour/type White  
 Required components:  
 C13658\_CLAMP-VERO13-18  
 Bender Wirth: 437 Typ L1

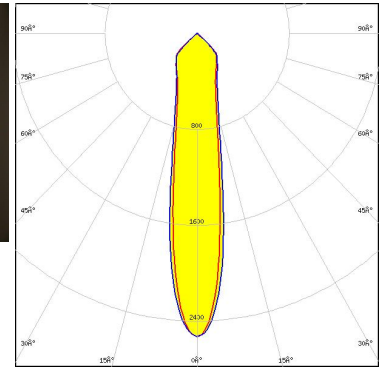
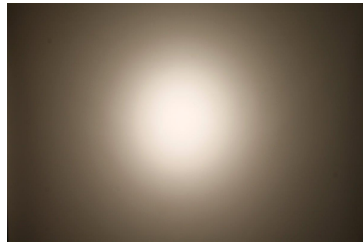

Light distribution files



LED CXA/B 1816 & CXA/B 1820 & CXA 1850  
 FWHM / FWTM 22.0° / 90.0°  
 Efficiency 89 %  
 Peak intensity 2 cd/lm  
 LEDs/each optic 1  
 Light colour/type White  
 Required components:  
 F13671\_ANGE-RZ-LENS  
 TE Connectivity: 2213401-2 + OPTIC CLIP Z50 TYPE1 2213194-1

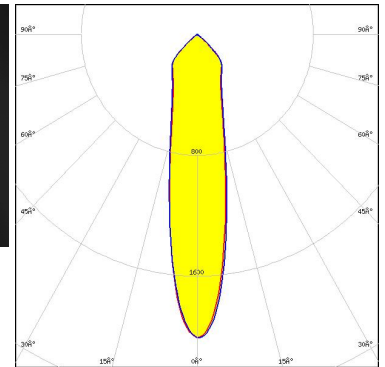
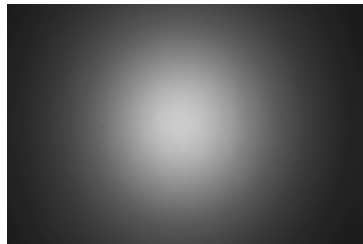

Light distribution files



LED CXA/B 1816 & CXA/B 1820 & CXA 1850  
 FWHM / FWTM 16.0° / 68.0°  
 Efficiency 94 %  
 Peak intensity 3.3 cd/lm  
 LEDs/each optic 1  
 Light colour/type White  
 Required components:  
 IDEAL: 50-2101CR + 50-2100AN

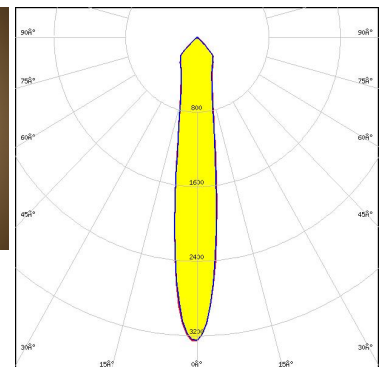
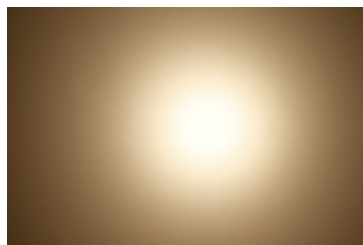

Light distribution files

### OPTICAL RESULTS (MEASURED):



LED CXA/B 25xx  
 FWHM / FWTM 22.0° / 87.0°  
 Efficiency 94 %  
 Peak intensity 2.3 cd/lm  
 LEDs/each optic 1  
 Light colour/type White  
 Required components:  
 IDEAL: 50-2102CR + 50-2100AN

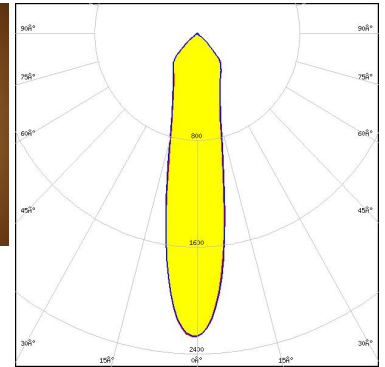
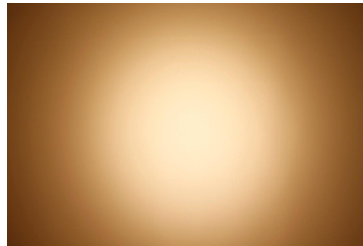

Light distribution files



LED CXA/B 25xx  
 FWHM / FWTM 25.0° / 92.0°  
 Efficiency 93 %  
 Peak intensity 1.9 cd/lm  
 LEDs/each optic 1  
 Light colour/type White  
 Required components:  
 C14036\_CLAMP\_CXA25-30

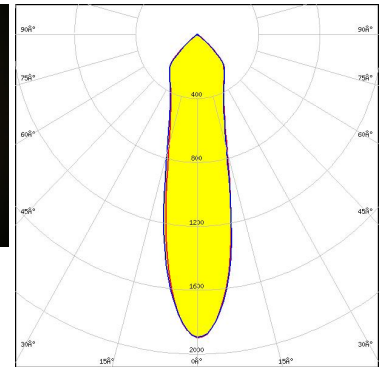

Light distribution files



LED CXA/B 30xx  
 FWHM / FWTM 32.0° / 95.0°  
 Efficiency 92 %  
 Peak intensity 1.5 cd/lm  
 LEDs/each optic 1  
 Light colour/type White  
 Required components:  
 C14036\_CLAMP\_CXA25-30

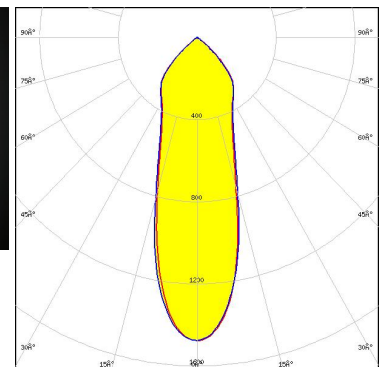
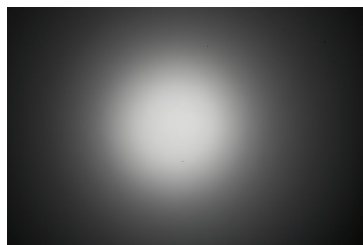

Light distribution files

### OPTICAL RESULTS (MEASURED):



LED CXA/B 30xx  
 FWHM / FWTM 28.0° / 89.0°  
 Efficiency 94 %  
 Peak intensity 1.7 cd/m  
 LEDs/each optic 1  
 Light colour/type White  
 Required components:  
 IDEAL: 50-2234C + 50-2100AN

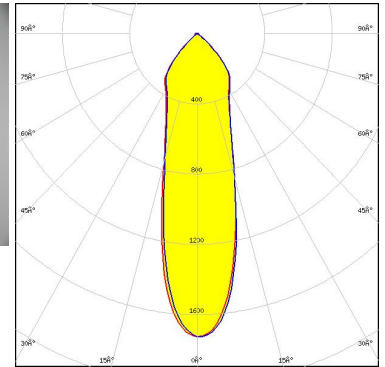
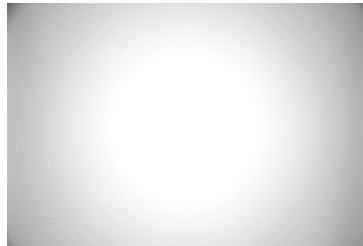

Light distribution files



LED CXA/B 3590  
 FWHM / FWTM 40.0° / 97.0°  
 Efficiency 93 %  
 Peak intensity 1.2 cd/m  
 LEDs/each optic 1  
 Light colour/type White  
 Required components:  
 IDEAL: 50-2303CR + 50-2300AN

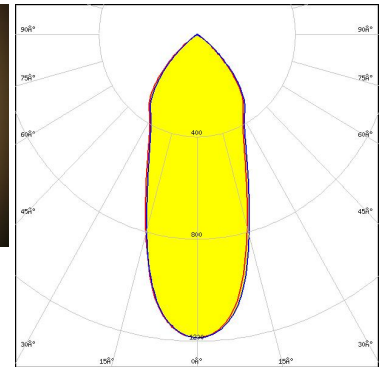
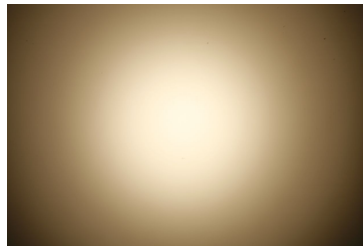

Light distribution files



LED CHI3030 19W  
 FWHM / FWTM 29.0° / 90.0°  
 Efficiency 88 %  
 Peak intensity 1.5 cd/m  
 LEDs/each optic 1  
 Light colour/type White  
 Required components:  
 C13584\_CLAMP-VERO29  
 F13671\_ANGE-RZ-LENS  
 Bender Wirth: 468 Typ L3

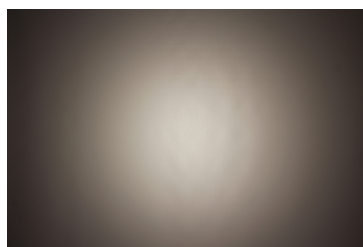

Light distribution files

### OPTICAL RESULTS (MEASURED):

#### EVERLIGHT

LED CHI3030 29W  
FWHM / FWTM 39.0° / 90.0°  
Efficiency 88 %  
Peak intensity 1.3 cd/lm  
LEDs/each optic 1  
Light colour/type White

Required components:

C13584\_CLAMP-VERO29  
F13671\_ANGE-RZ-LENS  
Bender Wirth: 468 Typ L3

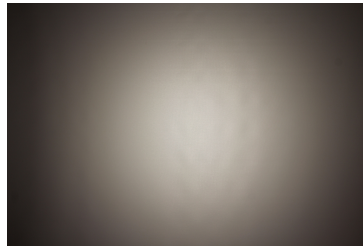

Light distribution files

#### inventronics

LED PrevaLED Core AC (LEP-2000)  
FWHM / FWTM 23.0° / 88.0°  
Efficiency 93 %  
Peak intensity 2.1 cd/lm  
LEDs/each optic 1  
Light colour/type White

Required components:

TE Connectivity: OPTIC CLIP Z50 TYPE1 2213194-1

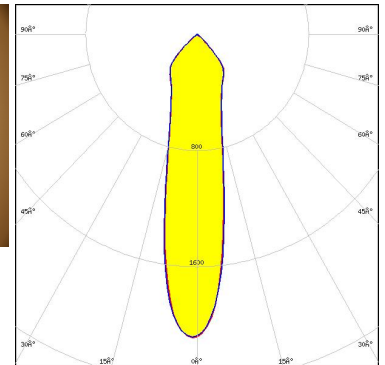

Light distribution files

#### inventronics

LED PrevaLED Core AC (LEP-800)  
FWHM / FWTM 16.0° / 76.0°  
Efficiency 94 %  
Peak intensity 3.1 cd/lm  
LEDs/each optic 1  
Light colour/type White

Required components:

TE Connectivity: OPTIC CLIP Z50 TYPE1 2213194-1

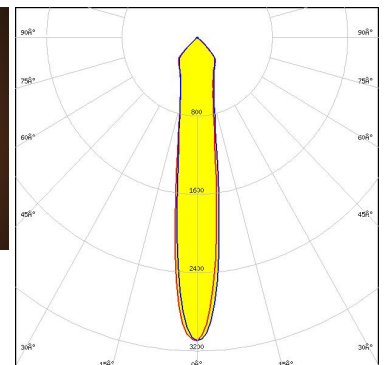
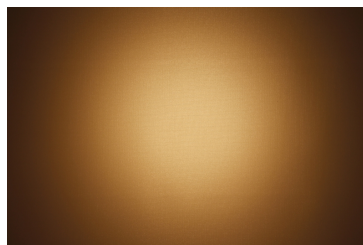

Light distribution files

### OPTICAL RESULTS (MEASURED):

#### inventronics

LED PrevaLED Core G7 L15 H1  
 FWHM / FWTM 21.0° / 88.0°  
 Efficiency 94 %  
 Peak intensity 2.4 cd/lm  
 LEDs/each optic 1  
 Light colour/type White  
 Required components:  
 C16685\_CLAMP-PRV-A

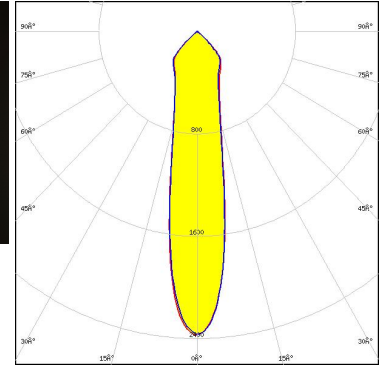

Light distribution files

#### inventronics

LED PrevaLED Core G7 L15 H1  
 FWHM / FWTM 24.0° / 90.0°  
 Efficiency 91 %  
 Peak intensity 1.9 cd/lm  
 LEDs/each optic 1  
 Light colour/type White  
 Required components:  
 C16685\_CLAMP-PRV-A  
 F13671\_ANGE-RZ-LENS

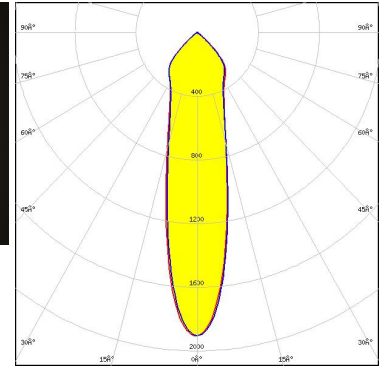

Light distribution files

#### inventronics

LED PrevaLED Core Z3 LES19  
 FWHM / FWTM 23.0° / 89.0°  
 Efficiency 94 %  
 Peak intensity 2.2 cd/lm  
 LEDs/each optic 1  
 Light colour/type White  
 Required components:  
 TE Connectivity: OPTIC CLIP Z50 TYPE1 2213194-1

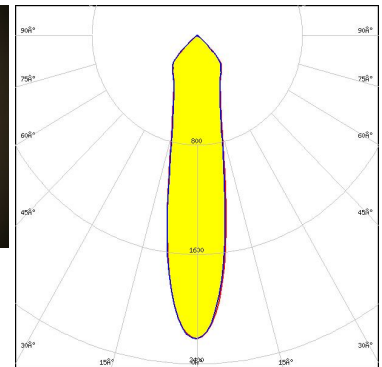

Light distribution files

### OPTICAL RESULTS (MEASURED):

#### inventronics

LED PrevaLED Core Z3 LES23  
 FWHM / FWTM 27.0° / 91.0°  
 Efficiency 94 %  
 Peak intensity 1.8 cd/lm  
 LEDs/each optic 1  
 Light colour/type White  
 Required components:  
 TE Connectivity: OPTIC CLIP Z50 TYPE1 2213194-1

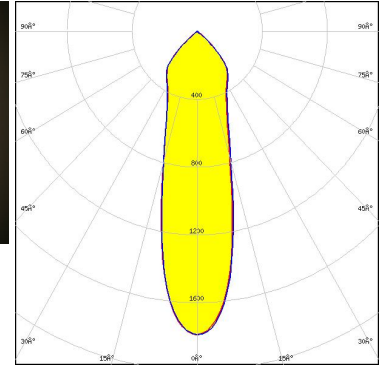

Light distribution files

#### inventronics

LED PrevaLED Core Z3 LES9  
 FWHM / FWTM 14.0° / 54.0°  
 Efficiency 94 %  
 Peak intensity 3.8 cd/lm  
 LEDs/each optic 1  
 Light colour/type White  
 Required components:  
 TE Connectivity: OPTIC CLIP Z50 TYPE1 2213194-1

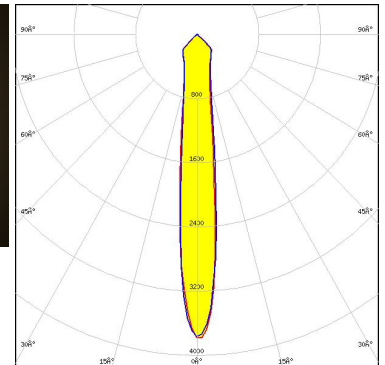
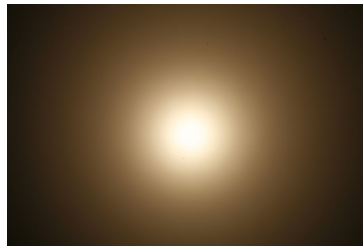

Light distribution files

#### inventronics

LED PrevaLED Core Z4 LES19  
 FWHM / FWTM 26.0° / 92.0°  
 Efficiency 88 %  
 Peak intensity 1.6 cd/lm  
 LEDs/each optic 1  
 Light colour/type White  
 Required components:  
 F13671\_ANGE-RZ-LENS  
 TE Connectivity: OPTIC CLIP Z50 TYPE1 2213194-1

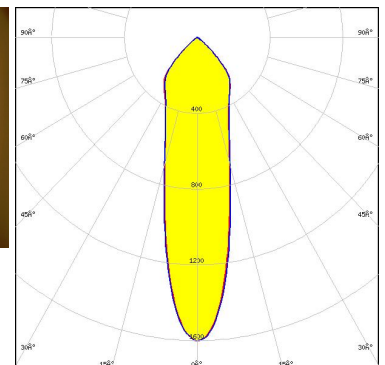
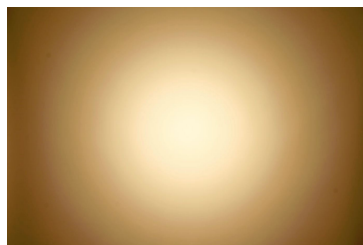

Light distribution files



#### OPTICAL RESULTS (MEASURED):

#### inventronics

LED PrevaLED Core Z4 LES19  
 FWHM / FWTM 21.0° / 87.0°  
 Efficiency 94 %  
 Peak intensity 2.3 cd/lm  
 LEDs/each optic 1  
 Light colour/type White  
 Required components:  
 TE Connectivity: OPTIC CLIP Z50 TYPE1 2213194-1

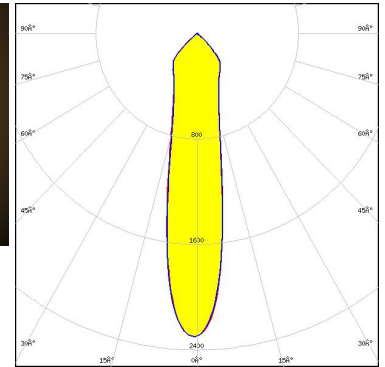

Light distribution files

#### LUMILEDS

LED LUXEON CoB 1202/1203  
 FWHM / FWTM 18.0° / 83.0°  
 Efficiency 93 %  
 Peak intensity 2.8 cd/lm  
 LEDs/each optic 1  
 Light colour/type White  
 Required components:  
 C13658\_CLAMP-VERO13-18  
 Bender Wirth: 438 Typ L1

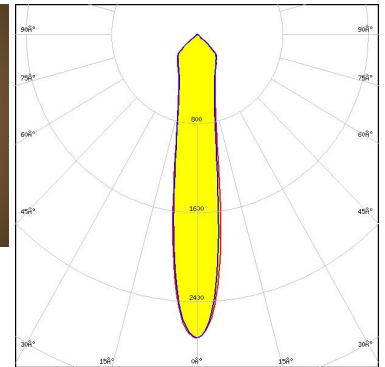
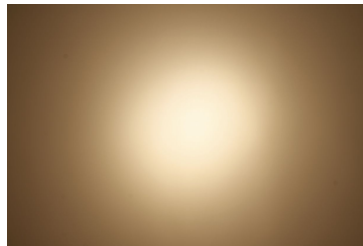

Light distribution files

#### LUMILEDS

LED LUXEON CoB 1204/1205  
 FWHM / FWTM 19.0° / 68.0°  
 Efficiency 94 %  
 Peak intensity 3.1 cd/lm  
 LEDs/each optic 1  
 Light colour/type White  
 Required components:  
 TE Connectivity: 2213130-2 + OPTIC CLIP Z50 TYPE1 2213194-1

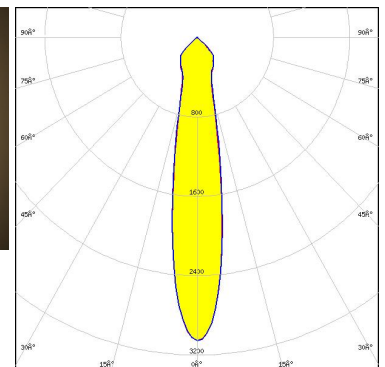

Light distribution files

### OPTICAL RESULTS (MEASURED):



LED LUXEON CoB 1204/1205  
FWHM / FWTM 17.0° / 76.0°  
Efficiency 94 %  
Peak intensity 3 cd/lm  
LEDs/each optic 1  
Light colour/type White  
Required components:  
IDEAL: 50-2100SH + 50-2100AN

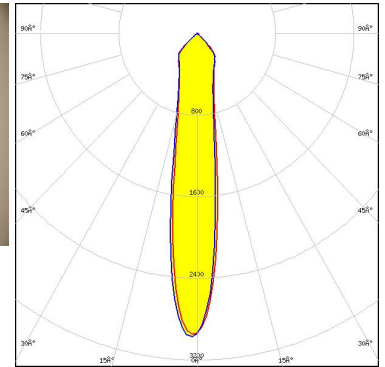
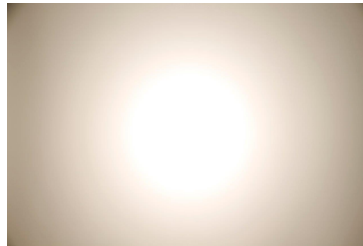

Light distribution files



LED LUXEON CoB 1204HD  
FWHM / FWTM 15.0° / 53.0°  
Efficiency 95 %  
Peak intensity 3.7 cd/lm  
LEDs/each optic 1  
Light colour/type White  
Required components:  
TE Connectivity: 2213382-2 + OPTIC CLIP Z50 TYPE1 2213194-1

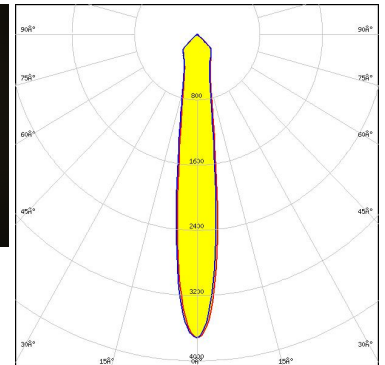
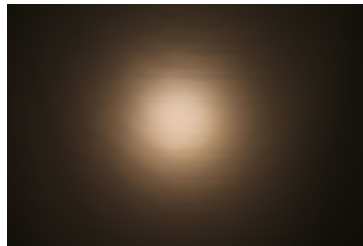

Light distribution files



LED LUXEON CoB 1205HD  
FWHM / FWTM 17.0° / 65.0°  
Efficiency 95 %  
Peak intensity 3.3 cd/lm  
LEDs/each optic 1  
Light colour/type White  
Required components:  
TE Connectivity: 2213382-2 + OPTIC CLIP Z50 TYPE1 2213194-1

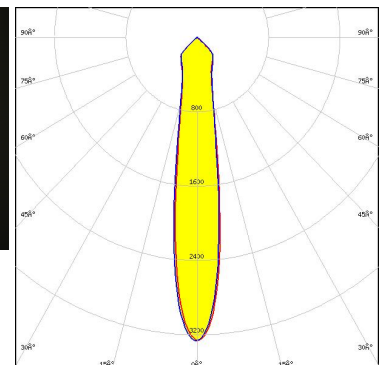
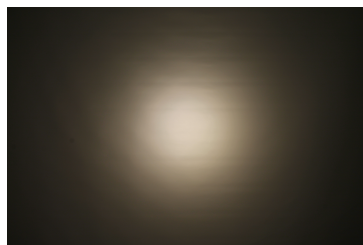

Light distribution files

### OPTICAL RESULTS (MEASURED):



LED LUXEON CoB 1208  
FWHM / FWTM 25.0° / 92.0°  
Efficiency 87 %  
Peak intensity 1.7 cd/lm  
LEDs/each optic 1  
Light colour/type White  
Required components:  
F13671\_ANGE-RZ-LENS  
TE Connectivity: 2213130-2 + OPTIC CLIP Z50 TYPE1 2213194-1

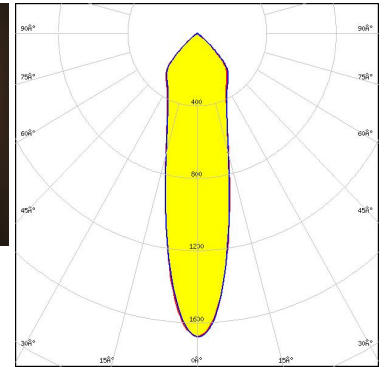
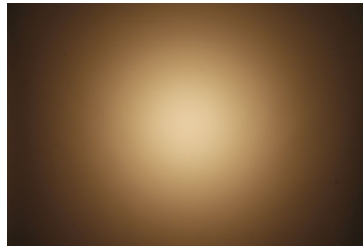

Light distribution files



LED LUXEON CoB 1208  
FWHM / FWTM 20.0° / 84.0°  
Efficiency 94 %  
Peak intensity 2.6 cd/lm  
LEDs/each optic 1  
Light colour/type White  
Required components:  
IDEAL: 50-2100SH + 50-2100AN

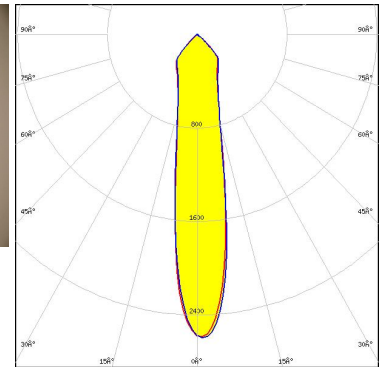
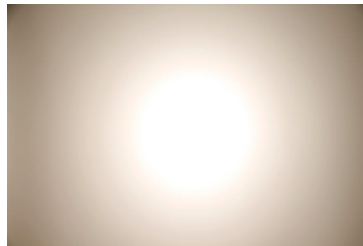

Light distribution files



LED LUXEON CoB 1208  
FWHM / FWTM 23.0° / 89.0°  
Efficiency 88 %  
Peak intensity 1.9 cd/lm  
LEDs/each optic 1  
Light colour/type White  
Required components:  
F13671\_ANGE-RZ-LENS  
IDEAL: 50-2100SH + 50-2100AN

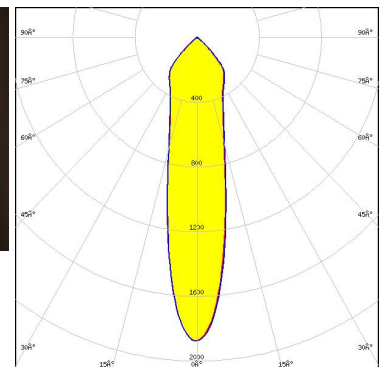
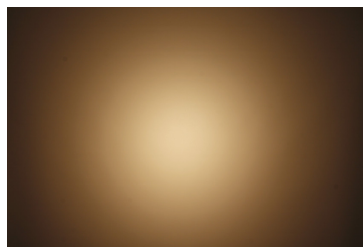

Light distribution files

### OPTICAL RESULTS (MEASURED):



**LED** LUXEON CoB 1208  
**FWHM / FWTM** 21.0° / 79.0°  
**Efficiency** 93 %  
**Peak intensity** 2.7 cd/lm  
**LEDs/each optic** 1  
**Light colour/type** White  
**Required components:**  
 TE Connectivity: 2213130-2 + OPTIC CLIP Z50 TYPE1 2213194-1

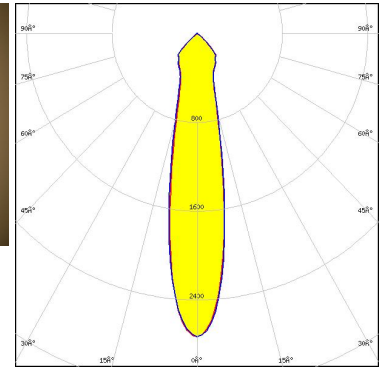

Light distribution files



**LED** LUXEON CoB 1211  
**FWHM / FWTM** 26.0° / 91.0°  
**Efficiency** 94 %  
**Peak intensity** 1.9 cd/lm  
**LEDs/each optic** 1  
**Light colour/type** White  
**Required components:**  
 C13584\_CLAMP-VERO29  
 Bender Wirth: 431 Typ L3

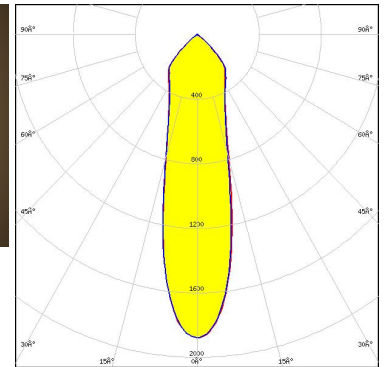
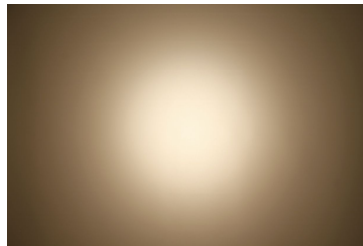

Light distribution files



**LED** LUXEON CoB 1211  
**FWHM / FWTM** 30.0° / 93.0°  
**Efficiency** 87 %  
**Peak intensity** 1.4 cd/lm  
**LEDs/each optic** 1  
**Light colour/type** White  
**Required components:**  
 F13671\_ANGE-RZ-LENS  
 IDEAL: 50-2204-CT + 50-2100AN

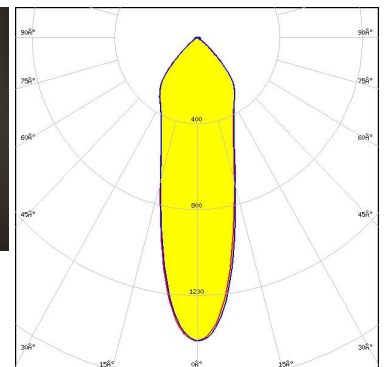
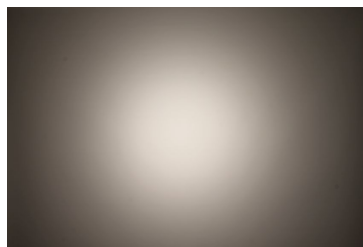

Light distribution files

### OPTICAL RESULTS (MEASURED):



LED LUXEON CoB 1211  
 FWHM / FWTM 26.0° / 91.0°  
 Efficiency 91 %  
 Peak intensity 1.7 cd/lm  
 LEDs/each optic 1  
 Light colour/type White  
 Required components:  
 IDEAL: 50-2204-CT + 50-2100AN

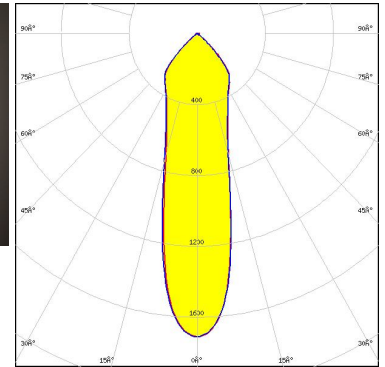
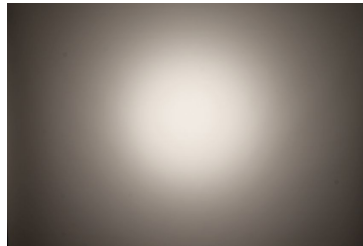

Light distribution files



LED LUXEON CoB 1213/1216/1812  
 FWHM / FWTM 31.0° / 93.0°  
 Efficiency 91 %  
 Peak intensity 1.4 cd/lm  
 LEDs/each optic 1  
 Light colour/type White  
 Required components:  
 IDEAL: 50-2204-CT + 50-2100AN

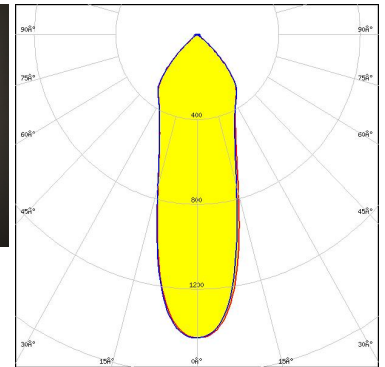
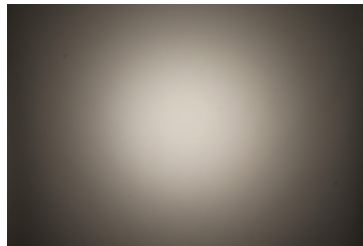

Light distribution files



LED LUXEON CoB 1213/1216/1812  
 FWHM / FWTM 34.0° / 95.0°  
 Efficiency 87 %  
 Peak intensity 1.2 cd/lm  
 LEDs/each optic 1  
 Light colour/type White  
 Required components:  
 F13671\_ANGE-RZ-LENS  
 IDEAL: 50-2204CT + 50-2100LN

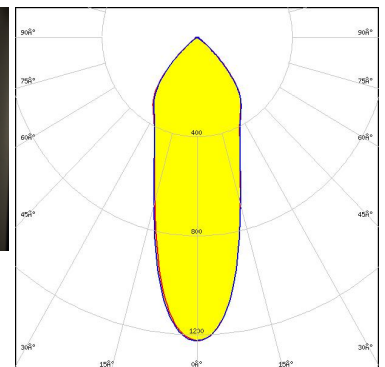

Light distribution files

### OPTICAL RESULTS (MEASURED):



LED LUXEON K12  
FWHM / FWTM 20.0° / 86.0°  
Efficiency 94 %  
Peak intensity 2.7 cd/lm  
LEDs/each optic 1  
Light colour/type White

Required components:

TE Connectivity: 2213134-2 + OPTIC CLIP Z50 TYPE1 2213194-1

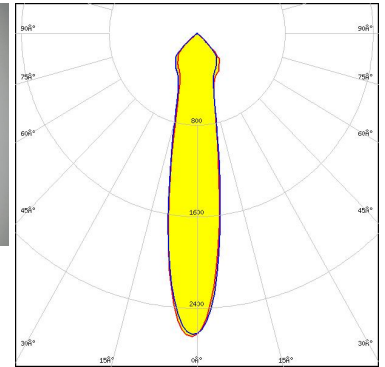
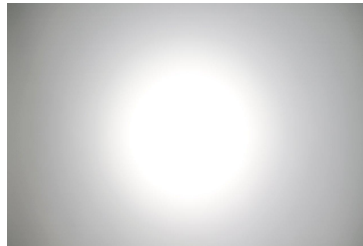

Light distribution files



LED LUXEON K12  
FWHM / FWTM 25.0° / 93.0°  
Efficiency 89 %  
Peak intensity 1.8 cd/lm  
LEDs/each optic 1  
Light colour/type White

Required components:

F13671\_ANGE-RZ-LENS  
TE Connectivity: 2213134-2 + OPTIC CLIP Z50 TYPE1 2213194-1

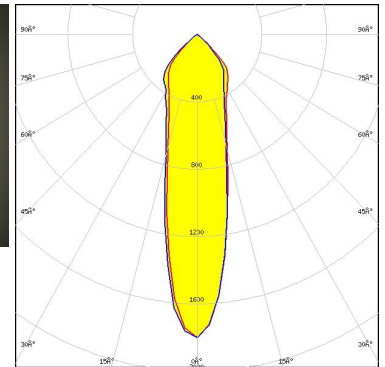
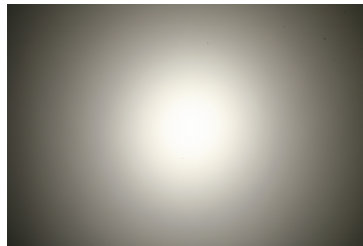

Light distribution files



LED LUXEON K16  
FWHM / FWTM 26.0° / 92.0°  
Efficiency 89 %  
Peak intensity 1.8 cd/lm  
LEDs/each optic 1  
Light colour/type White

Required components:

F13671\_ANGE-RZ-LENS  
TE Connectivity: 2213134-2 + OPTIC CLIP Z50 TYPE1 2213194-1

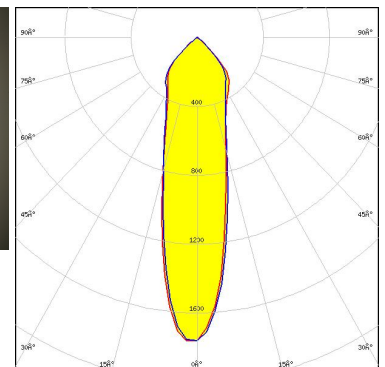
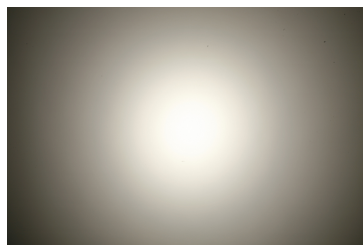

Light distribution files

### OPTICAL RESULTS (MEASURED):



LED LUXEON K16  
 FWHM / FWTM 22.0° / 90.0°  
 Efficiency 94 %  
 Peak intensity 2.3 cd/lm  
 LEDs/each optic 1  
 Light colour/type White

Required components:

TE Connectivity: 2213134-2 + OPTIC CLIP Z50 TYPE1 2213194-1

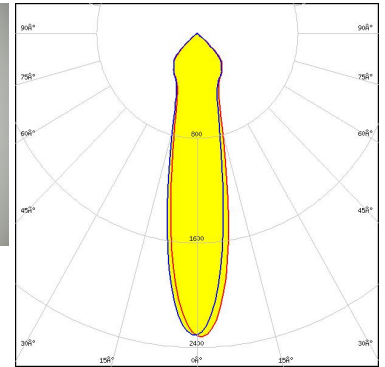
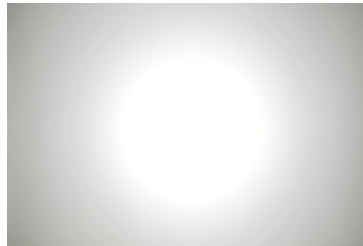

Light distribution files



LED LUXEON S2000  
 FWHM / FWTM 17.0° / 55.0°  
 Efficiency 93 %  
 Peak intensity 3.6 cd/lm  
 LEDs/each optic 1  
 Light colour/type White

Required components:

C13395\_CLAMP-S2000

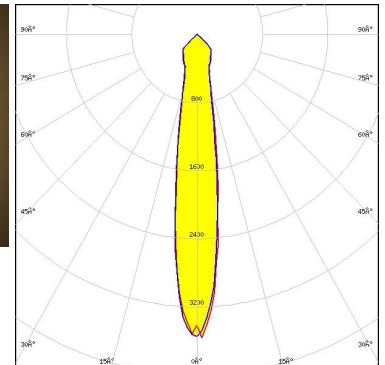

Light distribution files



LED LUXEON S3000  
 FWHM / FWTM 18.0° / 65.0°  
 Efficiency 92 %  
 Peak intensity 3.2 cd/lm  
 LEDs/each optic 1  
 Light colour/type White

Required components:

C13397\_CLAMP-S3000

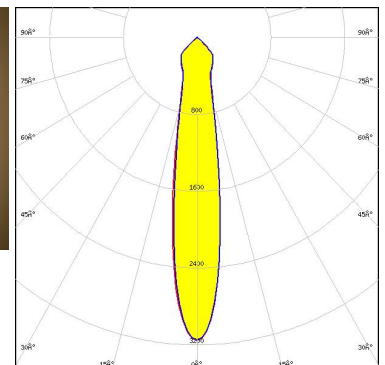

Light distribution files

### OPTICAL RESULTS (MEASURED):



LED LUXEON S5000  
 FWHM / FWTM 22.0° / 86.0°  
 Efficiency 93 %  
 Peak intensity 2.5 cd/lm  
 LEDs/each optic 1  
 Light colour/type White  
 Required components:  
 C13399\_CLAMP-S5000

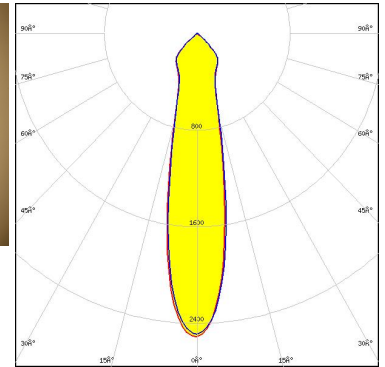

Light distribution files



LED CDM-14 (Dim-To-Warm)  
 FWHM / FWTM 23.0° / 89.0°  
 Efficiency 89 %  
 Peak intensity 2.1 cd/lm  
 LEDs/each optic 1  
 Light colour/type White  
 Required components:  
 C13658\_CLAMP-VERO13-18  
 F13671\_ANGE-RZ-LENS  
 Bender Wirth: 491 Typ L2

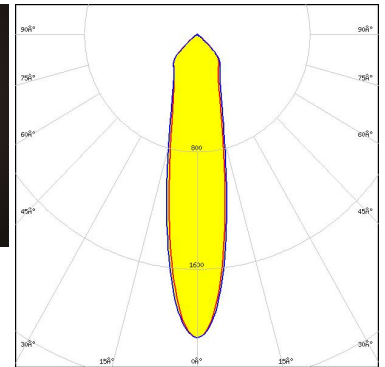
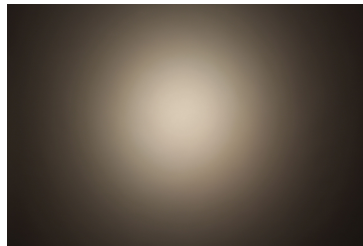

Light distribution files



LED CDM-14 (Dim-To-Warm)  
 FWHM / FWTM 20.0° / 80.0°  
 Efficiency 93 %  
 Peak intensity 2.6 cd/lm  
 LEDs/each optic 1  
 Light colour/type White  
 Required components:  
 C13658\_CLAMP-VERO13-18  
 Bender Wirth: 491 Typ L2

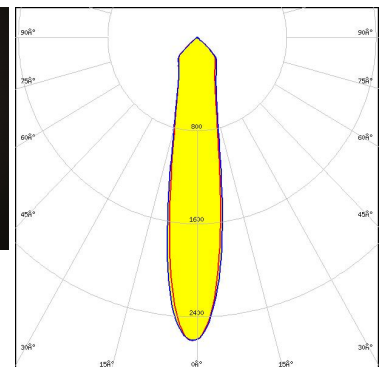
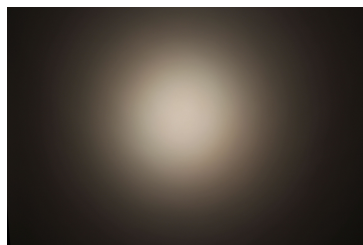

Light distribution files



### OPTICAL RESULTS (MEASURED):



LED CDM-18 (Dim-To-Warm)  
 FWHM / FWTM 26.0° / 91.0°  
 Efficiency 89 %  
 Peak intensity 1.8 cd/lm  
 LEDs/each optic 1  
 Light colour/type White  
 Required components:  
 C13658\_CLAMP-VERO13-18  
 F13671\_ANGE-RZ-LENS  
 Bender Wirth: 491 Typ L2

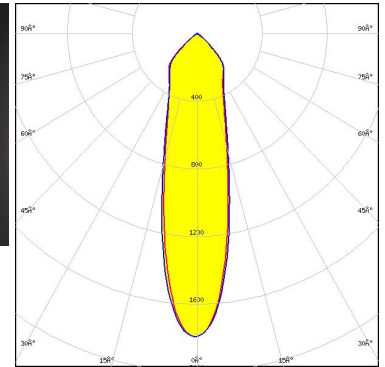
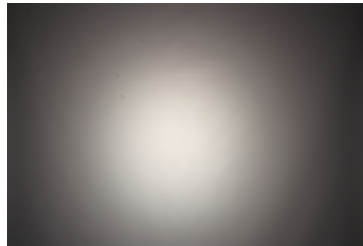

Light distribution files



LED CDM-18 (Dim-To-Warm)  
 FWHM / FWTM 24.0° / 89.0°  
 Efficiency 93 %  
 Peak intensity 2.2 cd/lm  
 LEDs/each optic 1  
 Light colour/type White  
 Required components:  
 C13658\_CLAMP-VERO13-18  
 Bender Wirth: 491 Typ L2

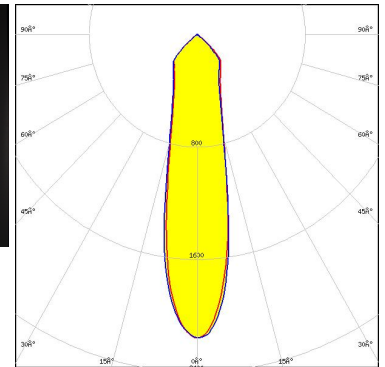
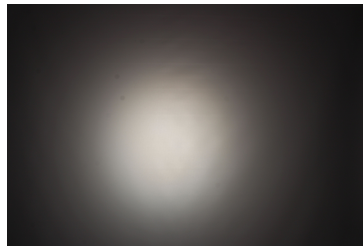

Light distribution files



LED CDM-9 (Dim-To-Warm)  
 FWHM / FWTM 18.0° / 81.0°  
 Efficiency 92 %  
 Peak intensity 2.7 cd/lm  
 LEDs/each optic 1  
 Light colour/type White  
 Required components:  
 C13658\_CLAMP-VERO13-18  
 Bender Wirth: 490 Typ L1

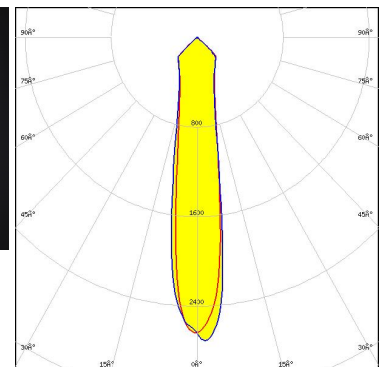
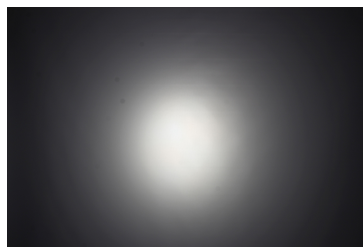

Light distribution files

#### OPTICAL RESULTS (MEASURED):



LED CDM-9 (Dim-To-Warm)  
 FWHM / FWTM 21.0° / 91.0°  
 Efficiency 87 %  
 Peak intensity 2.1 cd/lm  
 LEDs/each optic 1  
 Light colour/type White  
 Required components:  
 C13658\_CLAMP-VERO13-18  
 F13671\_ANGE-RZ-LENS  
 Bender Wirth: 490 Typ L1

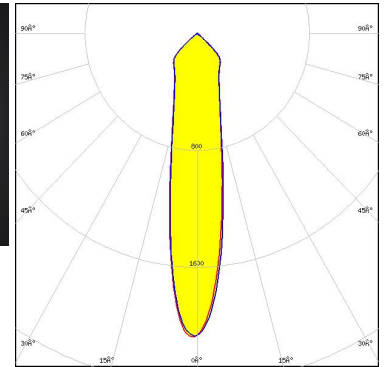
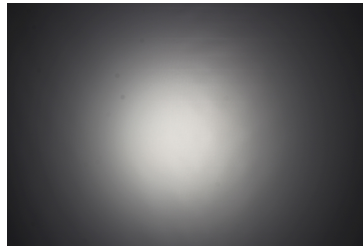

Light distribution files



LED CTM-14 (Tunable White)  
 FWHM / FWTM 23.0° / 90.0°  
 Efficiency 88 %  
 Peak intensity 2 cd/lm  
 LEDs/each optic 1  
 Light colour/type White  
 Required components:  
 C13584\_CLAMP-VERO29  
 F13671\_ANGE-RZ-LENS  
 Bender Wirth: 442 Typ L3

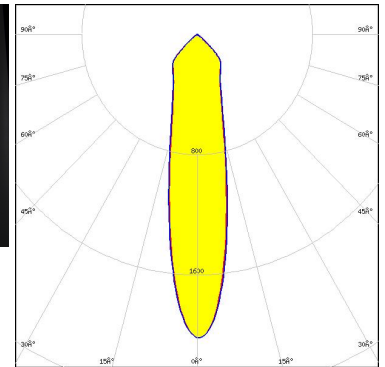
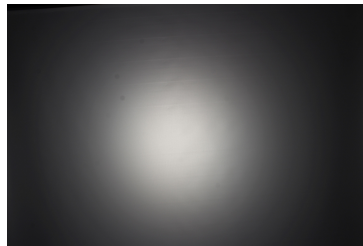

Light distribution files



LED CTM-14 (Tunable White)  
 FWHM / FWTM 20.0° / 86.0°  
 Efficiency 93 %  
 Peak intensity 2.6 cd/lm  
 LEDs/each optic 1  
 Light colour/type White  
 Required components:  
 C13584\_CLAMP-VERO29  
 Bender Wirth: 442 Typ L3

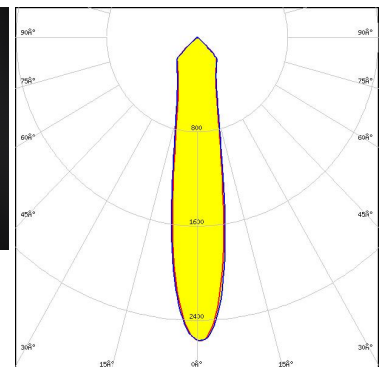
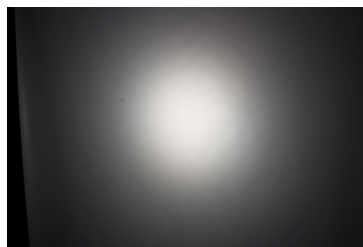

Light distribution files

### OPTICAL RESULTS (MEASURED):



LED CTM-14 RGBW  
 FWHM / FWTM 18.0° / 62.0°  
 Efficiency 94 %  
 Peak intensity 3.2 cd/lm  
 LEDs/each optic 1  
 Light colour/type RGBW  
 Required components:  
 C13584\_CLAMP-VERO29  
 Bender Wirth: 500 Typ L3-1

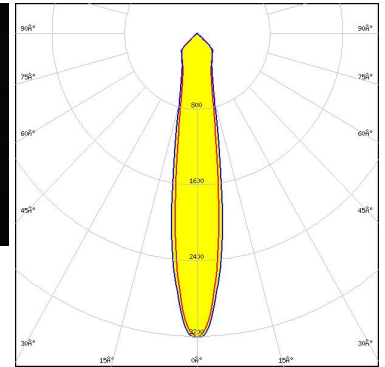

Light distribution files



LED CTM-14 RGBW  
 FWHM / FWTM 22.0° / 87.0°  
 Efficiency 90 %  
 Peak intensity 2.2 cd/lm  
 LEDs/each optic 1  
 Light colour/type RGBW  
 Required components:  
 C13584\_CLAMP-VERO29  
 F13671\_ANGE-RZ-LENS  
 Bender Wirth: 500 Typ L3-1

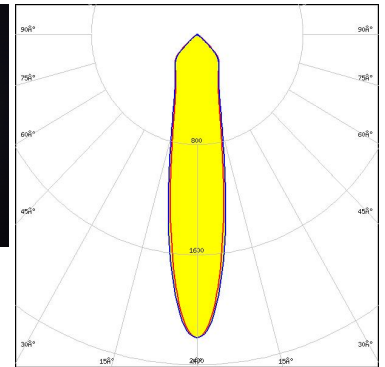

Light distribution files



LED CTM-22 (Tunable White)  
 FWHM / FWTM 32.0° / 95.0°  
 Efficiency 87 %  
 Peak intensity 1.4 cd/lm  
 LEDs/each optic 1  
 Light colour/type White  
 Required components:  
 C13584\_CLAMP-VERO29  
 F13671\_ANGE-RZ-LENS  
 Bender Wirth: 494 Typ L3

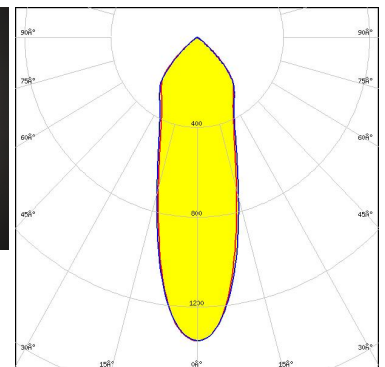
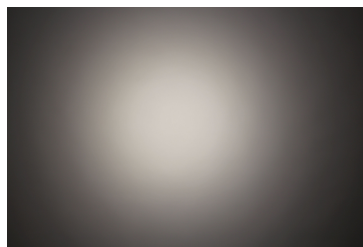

Light distribution files

### OPTICAL RESULTS (MEASURED):



**LED** CTM-22 (Tunable White)  
**FWHM / FWTM** 29.0°  
**Efficiency** 91 %  
**Peak intensity** 1.6 cd/lm  
**LEDs/each optic** 1  
**Light colour/type** White  
**Required components:**  
 C13584\_CLAMP-VERO29  
 Bender Wirth: 494 Typ L3

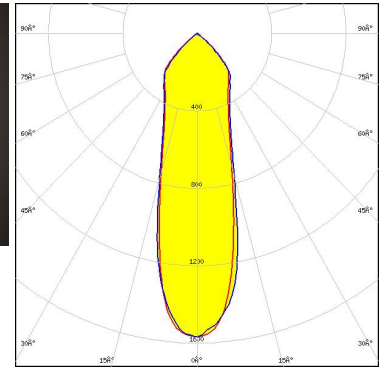
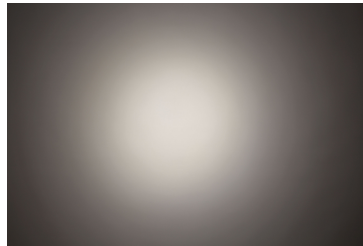

Light distribution files



**LED** CxM-14 (19x19)  
**FWHM / FWTM** 20.0° / 86.0°  
**Efficiency** 94 %  
**Peak intensity** 2.5 cd/lm  
**LEDs/each optic** 1  
**Light colour/type** White  
**Required components:**  
 TE Connectivity: 2213254-2 + OPTIC CLIP Z50 TYPE1 2213194-1

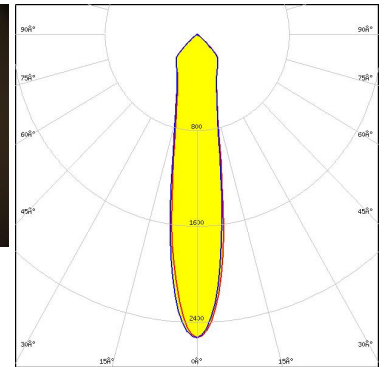
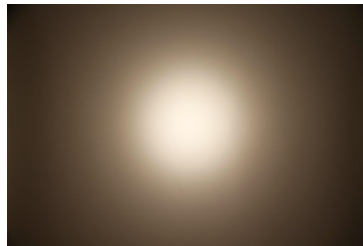

Light distribution files



**LED** COB J-Type  
**FWHM / FWTM** 22.0° / 89.0°  
**Efficiency** 93 %  
**Peak intensity** 2.3 cd/lm  
**LEDs/each optic** 1  
**Light colour/type** White  
**Required components:**  
 C13658\_CLAMP-VERO13-18  
 Bender Wirth: 463 Typ L2

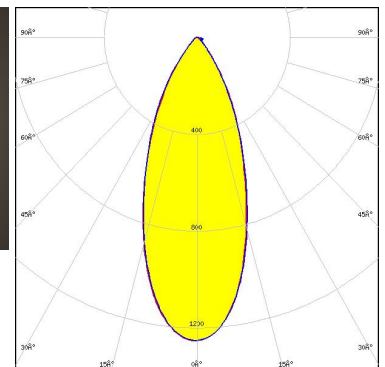
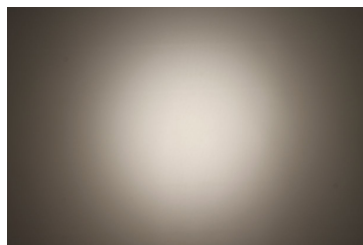

Light distribution files

### OPTICAL RESULTS (MEASURED):



**LED** COB J-Type  
**FWHM / FWTM** 24.0° / 90.0°  
**Efficiency** 87 %  
**Peak intensity** 1.7 cd/lm  
**LEDs/each optic** 1  
**Light colour/type** White  
**Required components:**  
 F13671\_ANGE-RZ-LENS  
 IDEAL: 50-2103NC + 50-2100AN

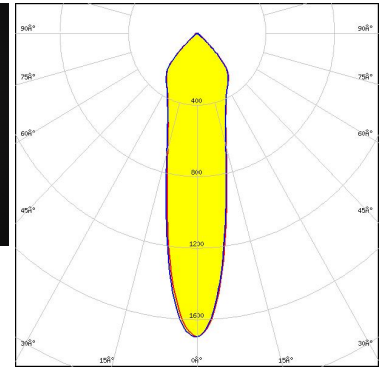
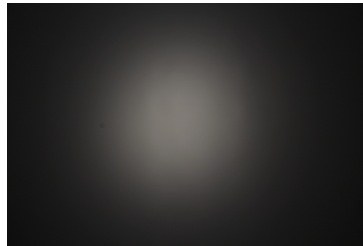

Light distribution files



**LED** COB J-Type  
**FWHM / FWTM** 20.0° / 85.0°  
**Efficiency** 94 %  
**Peak intensity** 2.5 cd/lm  
**LEDs/each optic** 1  
**Light colour/type** White  
**Required components:**  
 IDEAL: 50-2103NC + 50-2100AN

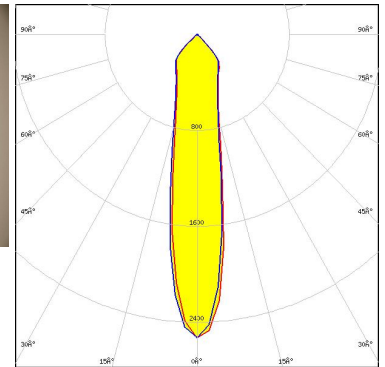
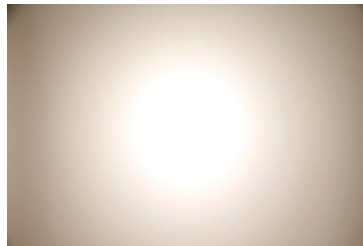

Light distribution files



**LED** COB L-Type (LES 11)  
**FWHM / FWTM** 17.0° / 86.0°  
**Efficiency** 92 %  
**Peak intensity** 2.7 cd/lm  
**LEDs/each optic** 1  
**Light colour/type** White  
**Required components:**  
 TE Connectivity: 2213382-2 + OPTIC CLIP Z50 TYPE1 2213194-1

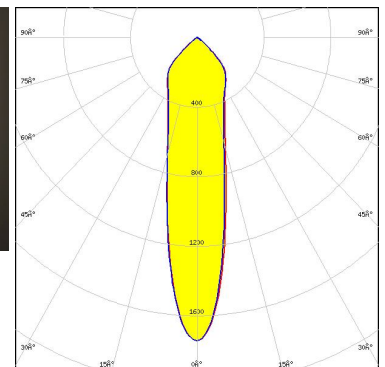
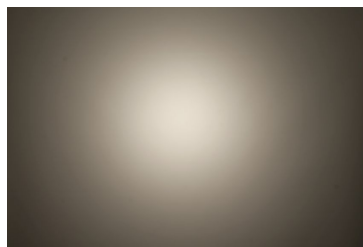

Light distribution files

#### OPTICAL RESULTS (MEASURED):



LED COB L-Type (LES 11)  
 FWHM / FWTM 18.0° / 78.0°  
 Efficiency 93 %  
 Peak intensity 2.8 cd/lm  
 LEDs/each optic 1  
 Light colour/type White  
 Required components:  
 C13658\_CLAMP-VERO13-18  
 Bender Wirth: 438 Typ L1

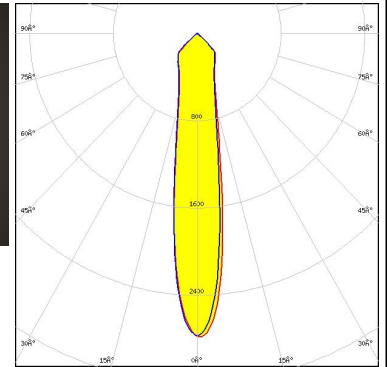

Light distribution files



LED COB L-Type (LES 11)  
 FWHM / FWTM 17.0° / 86.0°  
 Efficiency 92 %  
 Peak intensity 2.7 cd/lm  
 LEDs/each optic 1  
 Light colour/type White  
 Required components:  
 TE Connectivity: 2213382-2 + OPTIC CLIP Z50 TYPE1 2213194-1

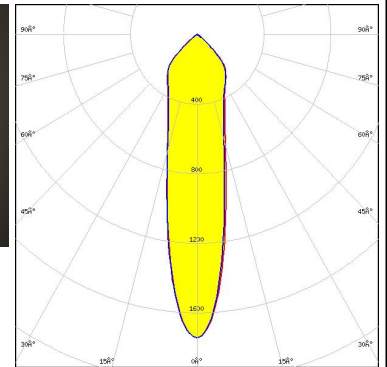

Light distribution files



LED COB L-Type (LES 11)  
 FWHM / FWTM 23.0° / 92.0°  
 Efficiency 86 %  
 Peak intensity 1.7 cd/lm  
 LEDs/each optic 1  
 Light colour/type White  
 Required components:  
 F13671\_ANGE-RZ-LENS  
 TE Connectivity: 2213382-2 + OPTIC CLIP Z50 TYPE1 2213194-1

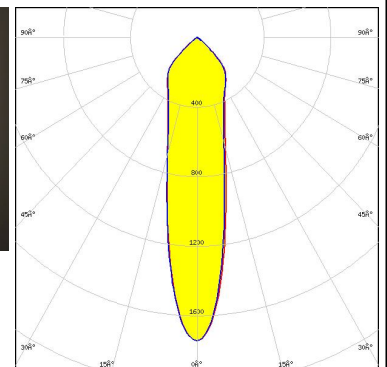
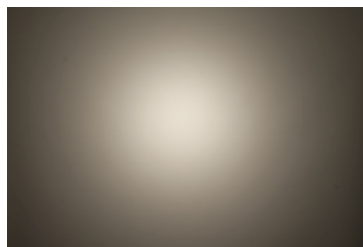

Light distribution files

### OPTICAL RESULTS (MEASURED):



**LED** COB L-Type (LES 11)  
**FWHM / FWTM** 22.0° / 93.0°  
**Efficiency** 94 %  
**Peak intensity** 2.2 cd/lm  
**LEDs/each optic** 1  
**Light colour/type** White  
**Required components:**  
 Molex: 180580-0005

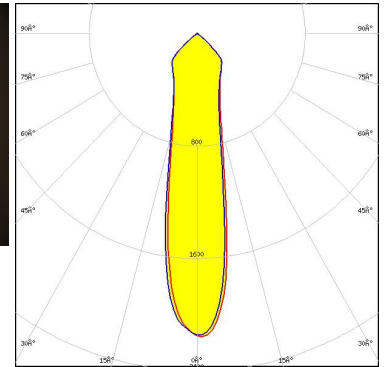

Light distribution files



**LED** COB L-Type (LES 11)  
**FWHM / FWTM** 16.0° / 71.0°  
**Efficiency** 91 %  
**Peak intensity** 3.1 cd/lm  
**LEDs/each optic** 1  
**Light colour/type** White  
**Required components:**  
 IDEAL: 50-2100NC + 50-2100AN

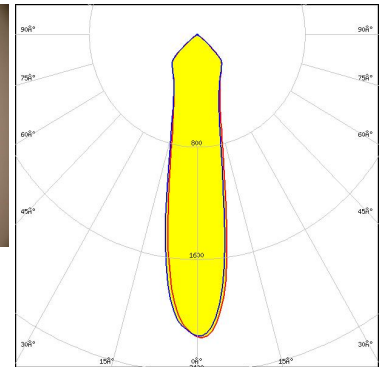
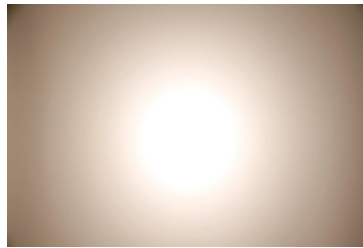

Light distribution files



**LED** COB L-Type (LES 11)  
**FWHM / FWTM** 19.0° / 88.0°  
**Efficiency** 87 %  
**Peak intensity** 2.1 cd/lm  
**LEDs/each optic** 1  
**Light colour/type** White  
**Required components:**  
 F13671\_ANGE-RZ-LENS  
 IDEAL: 50-2100NC + 50-2100AN

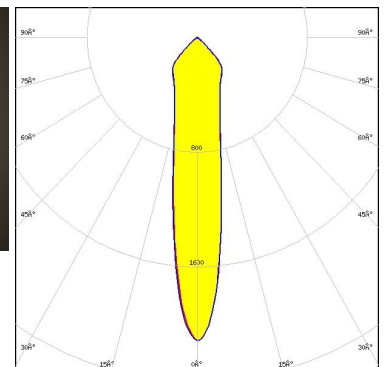
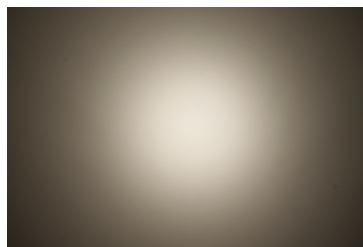

Light distribution files

### OPTICAL RESULTS (MEASURED):



LED NVCWJ024Z-V1MT: COB J-Type Tunable White  
 FWHM / FWTM 18.0° / 80.0°  
 Efficiency 93 %  
 Peak intensity 2.8 cd/lm  
 LEDs/each optic 1  
 Light colour/type White  
 Required components:  
 C13658\_CLAMP-VERO13-18  
 Bender Wirth: 498 Typ L2

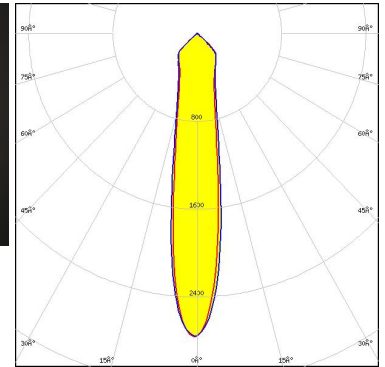
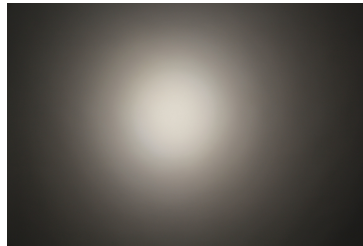

Light distribution files



LED NVCWJ024Z-V1MT: COB J-Type Tunable White  
 FWHM / FWTM 22.0° / 91.0°  
 Efficiency 88 %  
 Peak intensity 2 cd/lm  
 LEDs/each optic 1  
 Light colour/type White  
 Required components:  
 C13658\_CLAMP-VERO13-18  
 F13671\_ANGE-RZ-LENS  
 Bender Wirth: 498 Typ L2

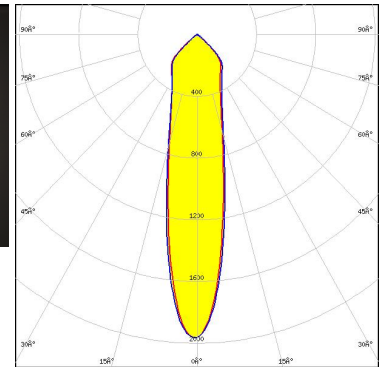
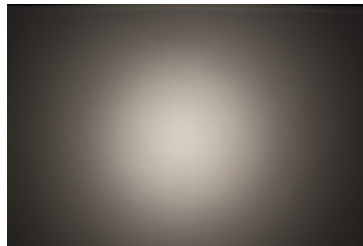

Light distribution files



LED Soleriq S13  
 FWHM / FWTM 20.0° / 89.0°  
 Efficiency 92 %  
 Peak intensity 2.4 cd/lm  
 LEDs/each optic 1  
 Light colour/type White  
 Required components:  
 C13658\_CLAMP-VERO13-18  
 Bender Wirth: 437 Typ L1

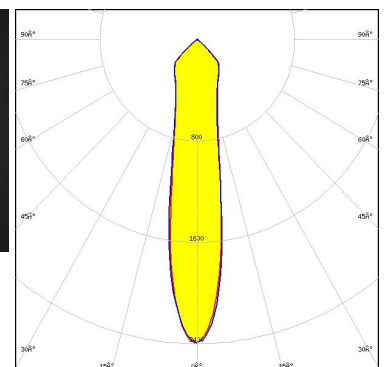
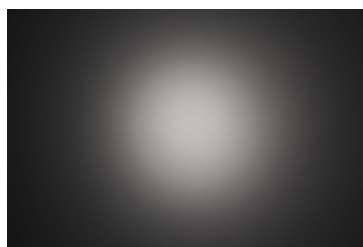

Light distribution files



### OPTICAL RESULTS (MEASURED):

**OSRAM**  
Opto Semiconductors

LED Soleriq S13  
FWHM / FWTM 20.0° / 82.0°  
Efficiency 94 %  
Peak intensity 2.8 cd/lm  
LEDs/each optic 1  
Light colour/type White

Required components:

TE Connectivity: 2213401-2 + OPTIC CLIP Z50 TYPE1 2213194-1

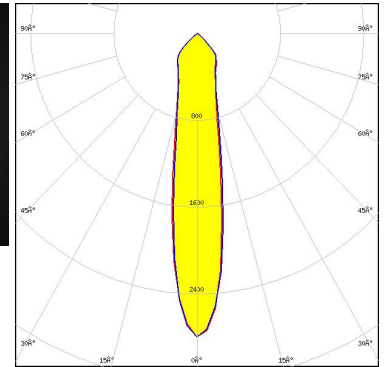

Light distribution files

**OSRAM**  
Opto Semiconductors

LED Soleriq S13 19x19  
FWHM / FWTM 17.0° / 86.0°  
Efficiency 91 %  
Peak intensity 2.6 cd/lm  
LEDs/each optic 1  
Light colour/type White

Required components:

IDEAL: 50-2103CT + 50-2100AN

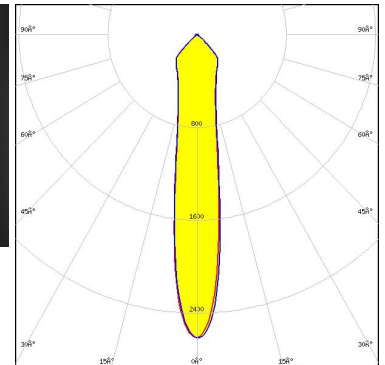
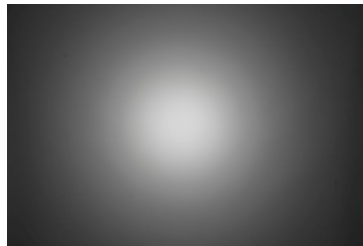

Light distribution files

**OSRAM**  
Opto Semiconductors

LED Soleriq S13 19x19  
FWHM / FWTM 22.0° / 90.0°  
Efficiency 88 %  
Peak intensity 2.1 cd/lm  
LEDs/each optic 1  
Light colour/type White

Required components:

F13671\_ANGE-RZ-LENS

TE Connectivity: 2213254-2 + OPTIC CLIP Z50 TYPE1 2213194-1

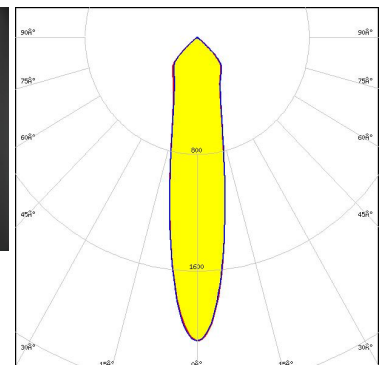
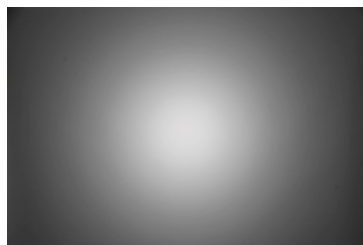

Light distribution files

### OPTICAL RESULTS (MEASURED):

**OSRAM**  
Opto Semiconductors

LED Soleriq S13 19x19  
 FWHM / FWTM 22.0° / 90.0°  
 Efficiency 87 %  
 Peak intensity 1.9 cd/lm  
 LEDs/each optic 1  
 Light colour/type White  
 Required components:  
 F13671\_ANGE-RZ-LENS  
 IDEAL: 50-2103CT + 50-2100AN

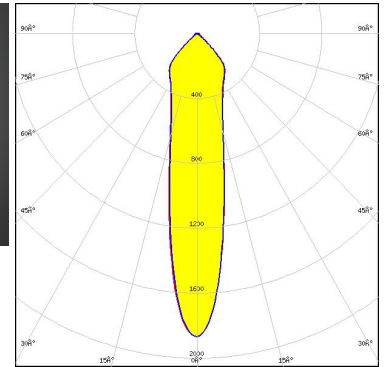

Light distribution files

**OSRAM**  
Opto Semiconductors

LED Soleriq S13 19x19  
 FWHM / FWTM 19.0° / 84.0°  
 Efficiency 93 %  
 Peak intensity 2.7 cd/lm  
 LEDs/each optic 1  
 Light colour/type White  
 Required components:  
 TE Connectivity: 2213254-2 + OPTIC CLIP Z50 TYPE1 2213194-1

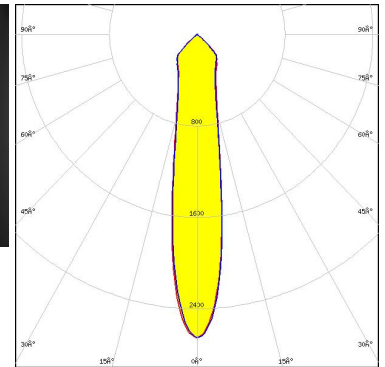
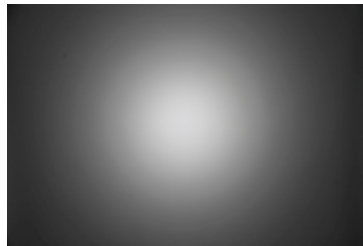

Light distribution files

**OSRAM**  
Opto Semiconductors

LED Soleriq S19  
 FWHM / FWTM 23.0° / 89.0°  
 Efficiency 92 %  
 Peak intensity 2.1 cd/lm  
 LEDs/each optic 1  
 Light colour/type White  
 Required components:  
 C13584\_CLAMP-VERO29  
 Bender Wirth: 462 Typ L3

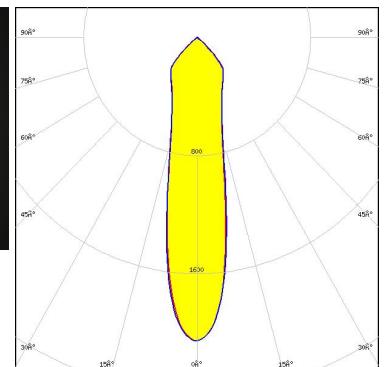
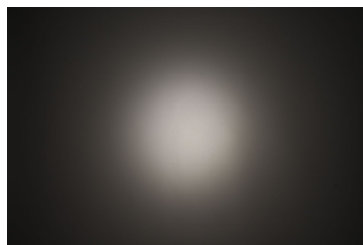

Light distribution files

### OPTICAL RESULTS (MEASURED):

**OSRAM**  
Opto Semiconductors

LED Soleriq S19  
 FWHM / FWTM 27.0° / 93.0°  
 Efficiency 88 %  
 Peak intensity 1.6 cd/lm  
 LEDs/each optic 1  
 Light colour/type White  
 Required components:  
 F13671\_ANGE-RZ-LENS  
 TE Connectivity: 2213407-2 + OPTIC CLIP Z50 TYPE1 2213194-1

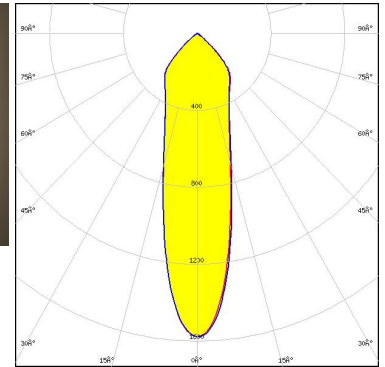
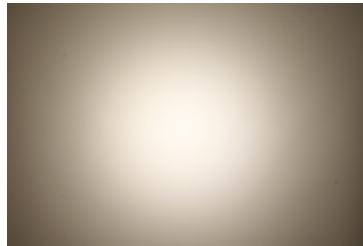

Light distribution files

**OSRAM**  
Opto Semiconductors

LED Soleriq S19  
 FWHM / FWTM 22.0° / 87.0°  
 Efficiency 94 %  
 Peak intensity 2.4 cd/lm  
 LEDs/each optic 1  
 Light colour/type White  
 Required components:  
 TE Connectivity: 2213407-2 + OPTIC CLIP Z50 TYPE1 2213194-1

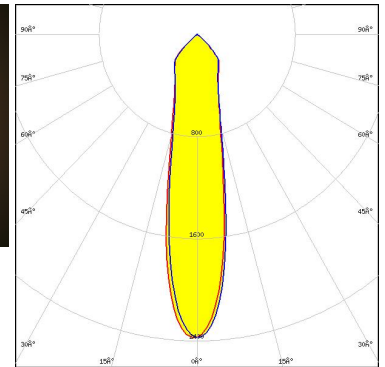

Light distribution files

**PHILIPS**

LED Fortimo SLM L09 + SLM holder  
 FWHM / FWTM 15.0° / 70.0°  
 Efficiency 92 %  
 Peak intensity 3.2 cd/lm  
 LEDs/each optic 1  
 Light colour/type White  
 Required components:  
 TE Connectivity: OPTIC CLIP Z50 TYPE1 2213194-1

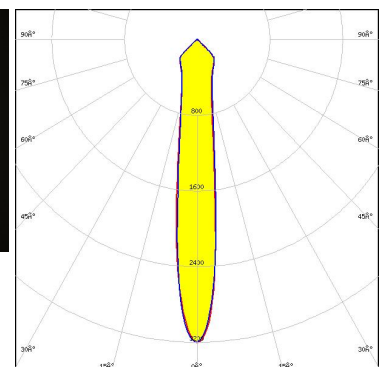

Light distribution files

### OPTICAL RESULTS (MEASURED):

#### PHILIPS

LED Fortimo SLM L13 + SLM holder  
FWHM / FWTM 19.0° / 86.0°  
Efficiency 92 %  
Peak intensity 2.6 cd/lm  
LEDs/each optic 1  
Light colour/type White  
Required components:  
TE Connectivity: OPTIC CLIP Z50 TYPE1 2213194-1

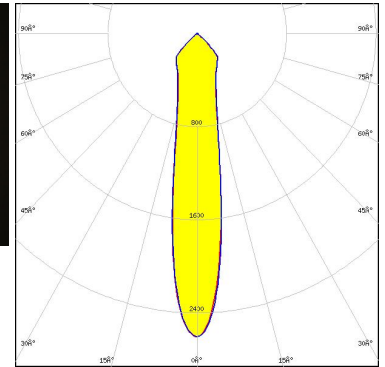

Light distribution files

#### PHILIPS

LED Fortimo SLM L13 CoB  
FWHM / FWTM 23.0° / 89.0°  
Efficiency 88 %  
Peak intensity 2 cd/lm  
LEDs/each optic 1  
Light colour/type White  
Required components:  
F13671\_ANGE-RZ-LENS  
TE Connectivity: 2213130-2 + OPTIC CLIP Z50 TYPE1 2213194-1

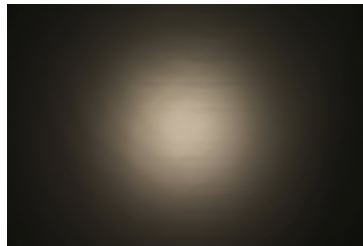

Light distribution files

#### PHILIPS

LED Fortimo SLM L13 CoB  
FWHM / FWTM 20.0° / 78.0°  
Efficiency 94 %  
Peak intensity 2.8 cd/lm  
LEDs/each optic 1  
Light colour/type White  
Required components:  
TE Connectivity: 2213130-2 + OPTIC CLIP Z50 TYPE1 2213194-1

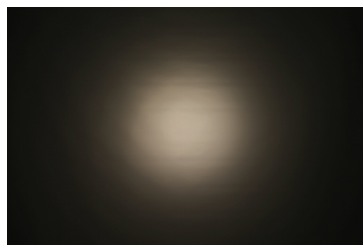

Light distribution files

### OPTICAL RESULTS (MEASURED):

#### PHILIPS

LED Fortimo SLM L15 + SLM holder  
 FWHM / FWTM 21.0° / 88.0°  
 Efficiency 91 %  
 Peak intensity 2.2 cd/lm  
 LEDs/each optic 1  
 Light colour/type White  
 Required components:  
 TE Connectivity: OPTIC CLIP Z50 TYPE1 2213194-1

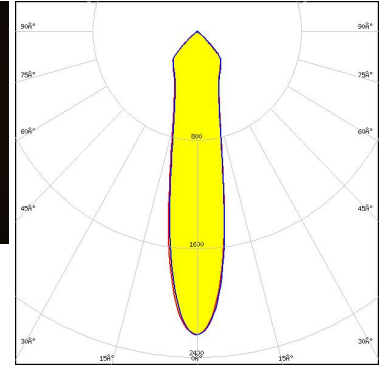
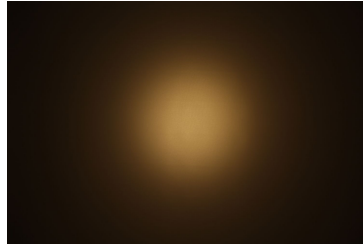

Light distribution files

#### PHILIPS

LED Fortimo SLM L15 + SLM holder  
 FWHM / FWTM 27.0° / 93.0°  
 Efficiency 87 %  
 Peak intensity 1.6 cd/lm  
 LEDs/each optic 1  
 Light colour/type White  
 Required components:  
 F13671\_ANGE-RZ-LENS  
 TE Connectivity: OPTIC CLIP Z50 TYPE1 2213194-1

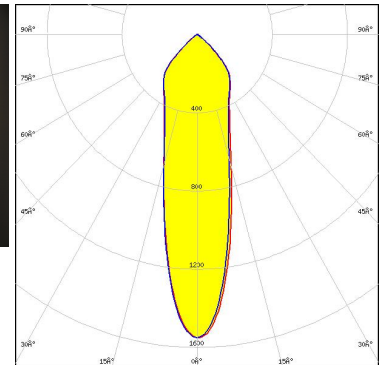
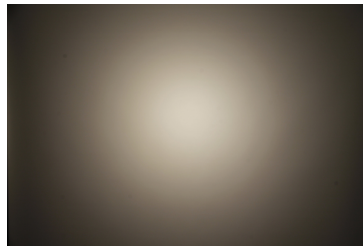

Light distribution files

#### PHILIPS

LED Fortimo SLM L15 CoB  
 FWHM / FWTM 22.0° / 86.0°  
 Efficiency 94 %  
 Peak intensity 2.5 cd/lm  
 LEDs/each optic 1  
 Light colour/type White  
 Required components:  
 TE Connectivity: 2213130-2 + OPTIC CLIP Z50 TYPE1 2213194-1

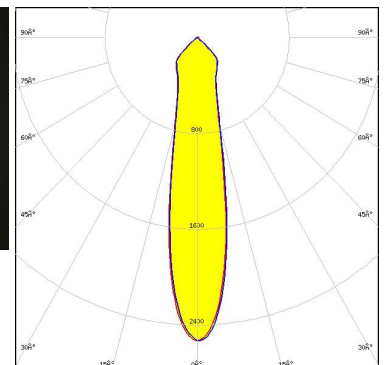
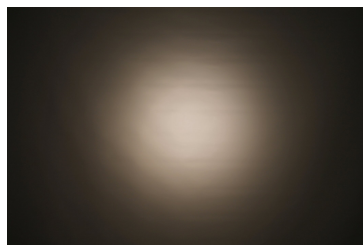

Light distribution files

#### OPTICAL RESULTS (MEASURED):

### PHILIPS

LED Fortimo SLM L15 CoB  
 FWHM / FWTM 24.0° / 90.0°  
 Efficiency 88 %  
 Peak intensity 2 cd/lm  
 LEDs/each optic 1  
 Light colour/type White  
 Required components:  
 F13671\_ANGE-RZ-LENS  
 TE Connectivity: 2213130-2 + OPTIC CLIP Z50 TYPE1 2213194-1

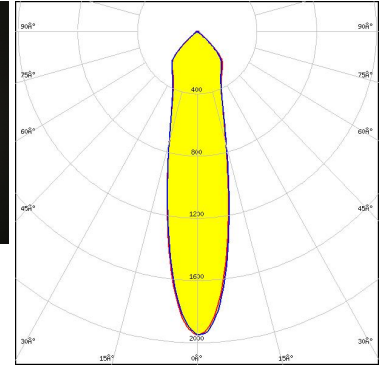

Light distribution files

### PHILIPS

LED Fortimo SLM L19 + SLM holder  
 FWHM / FWTM 26.0° / 91.0°  
 Efficiency 90 %  
 Peak intensity 1.8 cd/lm  
 LEDs/each optic 1  
 Light colour/type White  
 Required components:  
 TE Connectivity: OPTIC CLIP Z50 TYPE1 2213194-1

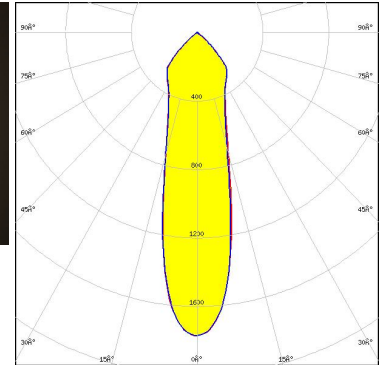
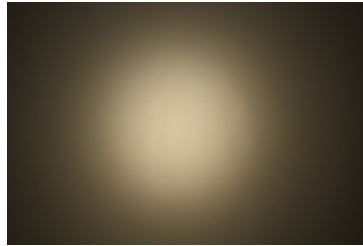

Light distribution files

### SAMSUNG

LED LC026B / 033B / 040B  
 FWHM / FWTM 25.0° / 92.0°  
 Efficiency 92 %  
 Peak intensity 1.8 cd/lm  
 LEDs/each optic 1  
 Light colour/type White  
 Required components:  
 C13658\_CLAMP-VERO13-18  
 Bender Wirth: 450 Typ L2

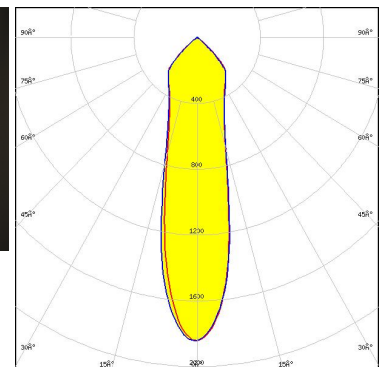
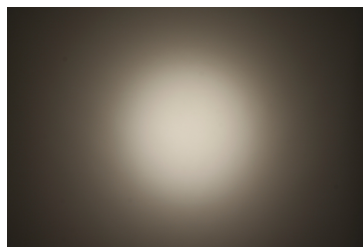

Light distribution files

### OPTICAL RESULTS (MEASURED):

#### SAMSUNG

LED LC026B / 033B / 040B

FWHM / FWTM 24.0° / 89.0°

Efficiency 93 %

Peak intensity 2.1 cd/lm

LEDs/each optic 1

Light colour/type White

Required components:

TE Connectivity: 2213258-2 + OPTIC CLIP Z50 TYPE1 2213194-1

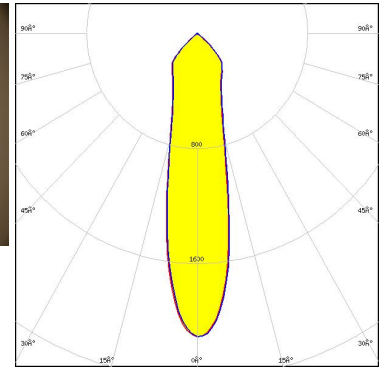
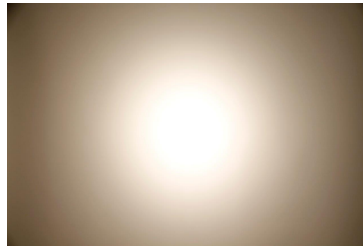

Light distribution files

#### SAMSUNG

LED LC035T (Tunable white)

FWHM / FWTM 31.0° / 93.0°

Efficiency 94 %

Peak intensity 1.6 cd/lm

LEDs/each optic 1

Light colour/type Tunable White

Required components:

C13584\_CLAMP-VERO29

Bender Wirth: 502 Typ L3

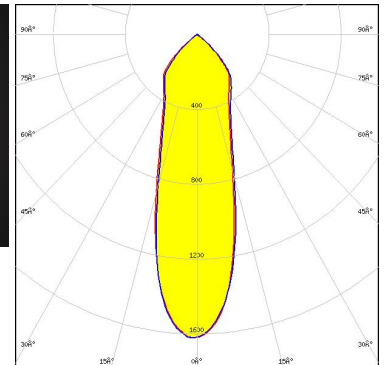
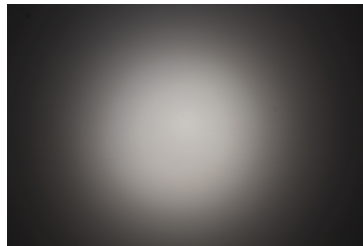

Light distribution files

#### SAMSUNG

LED LC035T (Tunable white)

FWHM / FWTM 34.0° / 95.0°

Efficiency 89 %

Peak intensity 1.3 cd/lm

LEDs/each optic 1

Light colour/type Tunable White

Required components:

C13584\_CLAMP-VERO29

F13671\_ANGE-RZ-LENS

Bender Wirth: 502 Typ L3

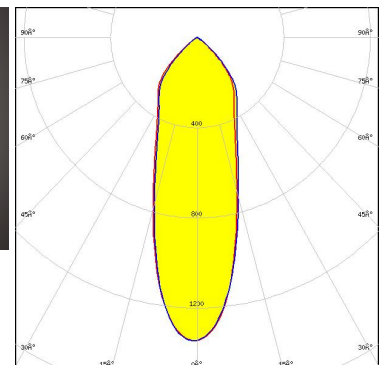
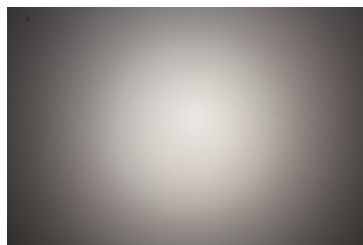

Light distribution files

### OPTICAL RESULTS (MEASURED):

#### SAMSUNG

LED LC040C  
FWHM / FWTM 18.0° / 87.0°  
Efficiency 92 %  
Peak intensity 2.6 cd/lm  
LEDs/each optic 1  
Light colour/type White

Required components:

TE Connectivity: 2213382-2 + OPTIC CLIP Z50 TYPE1 2213194-1

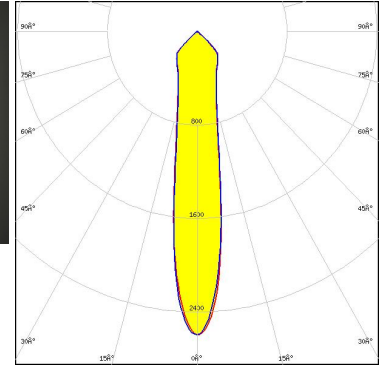

Light distribution files

#### SAMSUNG

LED LC040C  
FWHM / FWTM 21.0° / 89.0°  
Efficiency 89 %  
Peak intensity 2.2 cd/lm  
LEDs/each optic 1  
Light colour/type White

Required components:

F13671\_ANGE-RZ-LENS  
TE Connectivity: 2213382-2 + OPTIC CLIP Z50 TYPE1 2213194-1

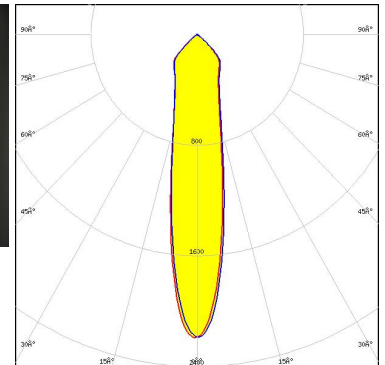
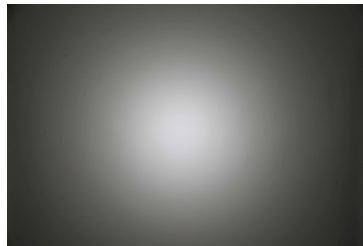

Light distribution files



LED AC Zhaga COB  
FWHM / FWTM 30.0° / 96.0°  
Efficiency 88 %  
Peak intensity 1.4 cd/lm  
LEDs/each optic 1  
Light colour/type White

Required components:

F13671\_ANGE-RZ-LENS  
Optosource: SEHSMJD-A

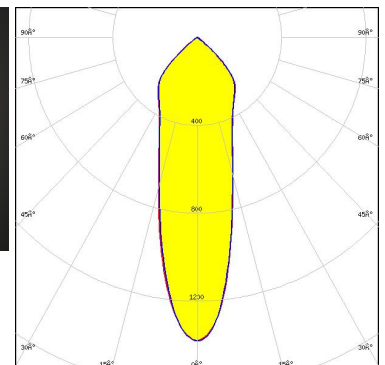
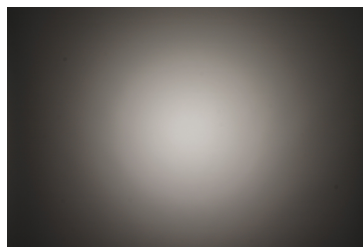

Light distribution files



### OPTICAL RESULTS (MEASURED):

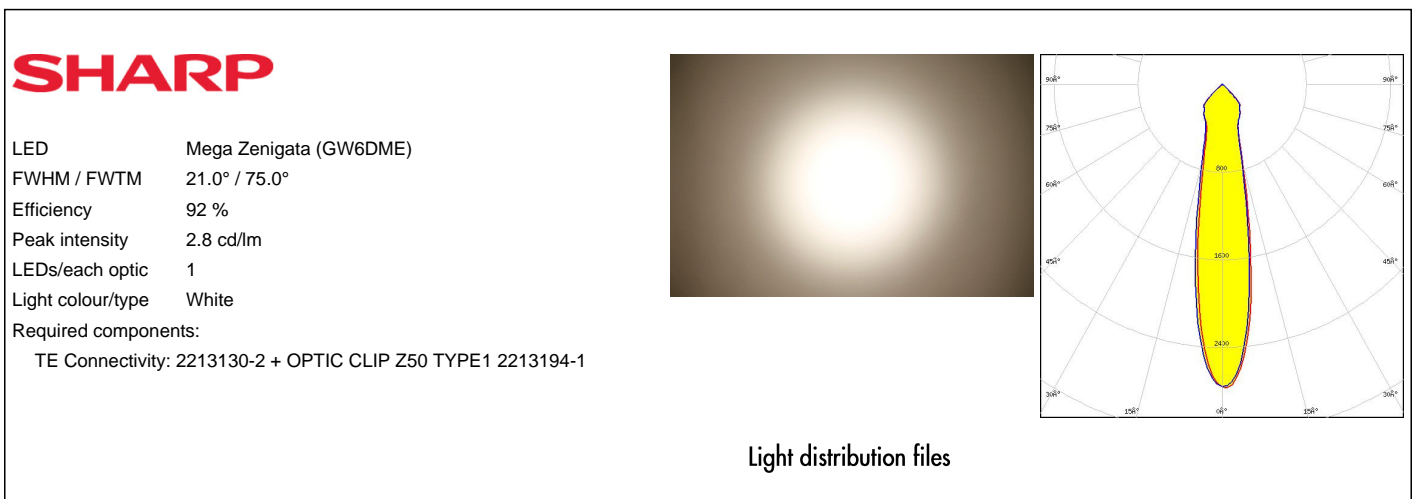
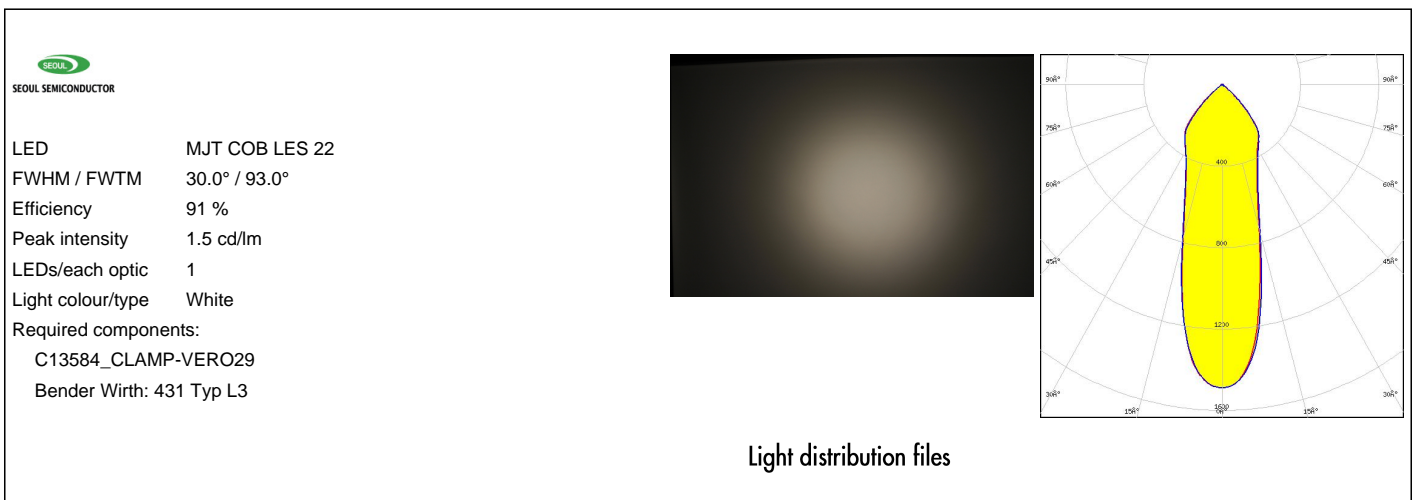
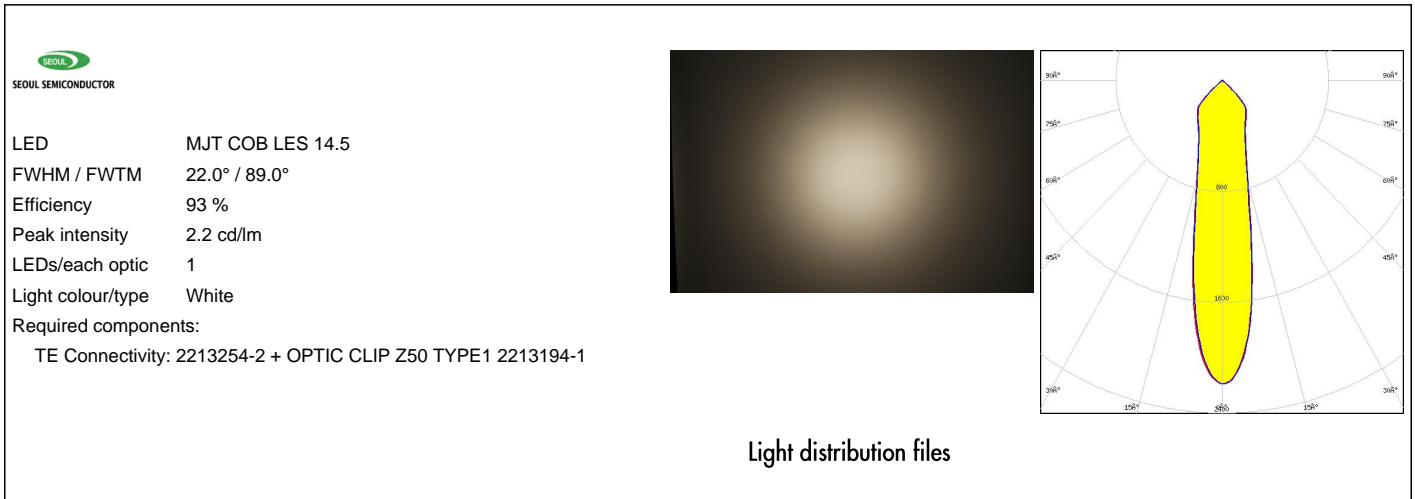

### OPTICAL RESULTS (MEASURED):

#### SHARP

LED Mega Zenigata (GW6DME)  
 FWHM / FWTM 20.0° / 84.0°  
 Efficiency 94 %  
 Peak intensity 2.7 cd/m  
 LEDs/each optic 1  
 Light colour/type White  
 Required components:  
 IDEAL: 50-2100SH + 50-2100AN

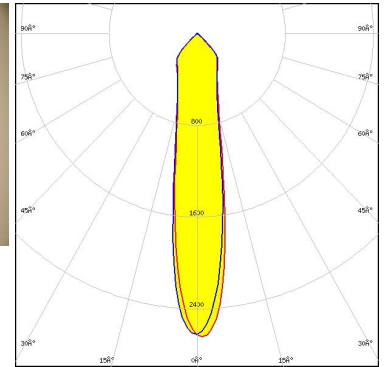
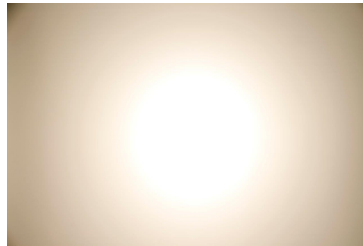

Light distribution files

#### SHARP

LED Mega Zenigata (GW6DME)  
 FWHM / FWTM 24.0° / 91.0°  
 Efficiency 89 %  
 Peak intensity 1.9 cd/m  
 LEDs/each optic 1  
 Light colour/type White  
 Required components:  
 F13671\_ANGE-RZ-LENS  
 TE Connectivity: 2213130-2 + OPTIC CLIP Z50 TYPE1 2213194-1

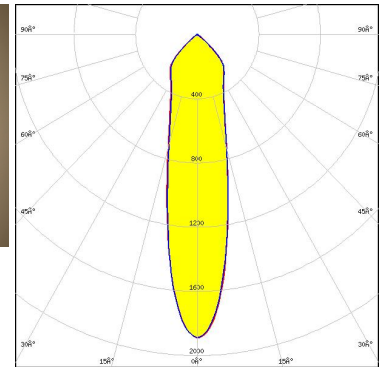

Light distribution files

#### VS LIGHTING SOLUTIONS

LED WU-M-461  
 FWHM / FWTM 20.0° / 78.0°  
 Efficiency 94 %  
 Peak intensity 2.7 cd/m  
 LEDs/each optic 1  
 Light colour/type White  
 Required components:  
 TE Connectivity: OPTIC CLIP Z50 TYPE1 2213194-1

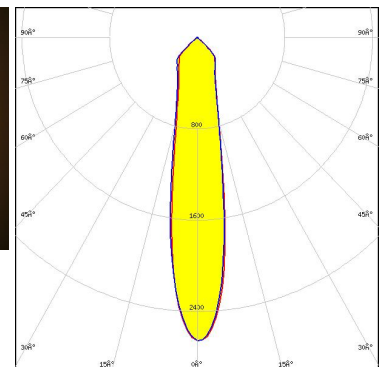
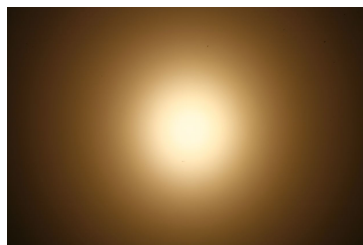

Light distribution files

### OPTICAL RESULTS (MEASURED):



**LED** WU-M-462  
**FWHM / FWTM** 26.0° / 89.0°  
**Efficiency** 94 %  
**Peak intensity** 2 cd/lm  
**LEDs/each optic** 1  
**Light colour/type** White  
**Required components:**  
 TE Connectivity: OPTIC CLIP Z50 TYPE1 2213194-1

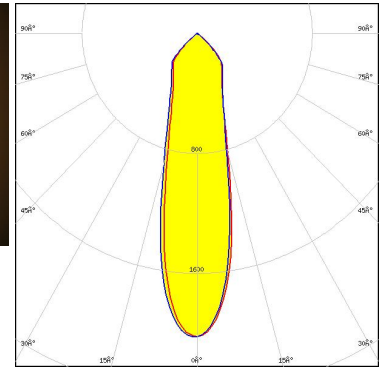

Light distribution files



**LED** WU-M-464  
**FWHM / FWTM** 26.0° / 89.0°  
**Efficiency** 94 %  
**Peak intensity** 2 cd/lm  
**LEDs/each optic** 1  
**Light colour/type** White  
**Required components:**  
 TE Connectivity: OPTIC CLIP Z50 TYPE1 2213194-1

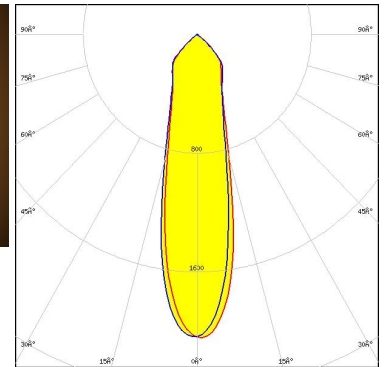
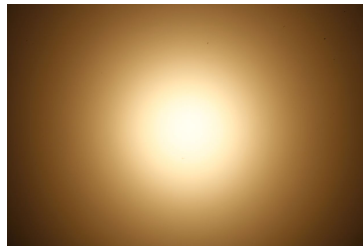

Light distribution files



**LED** WU-M-484  
**FWHM / FWTM** 21.0° / 88.0°  
**Efficiency** 93 %  
**Peak intensity** 2.4 cd/lm  
**LEDs/each optic** 1  
**Light colour/type** White  
**Required components:**  
 TE Connectivity: OPTIC CLIP Z50 TYPE1 2213194-1

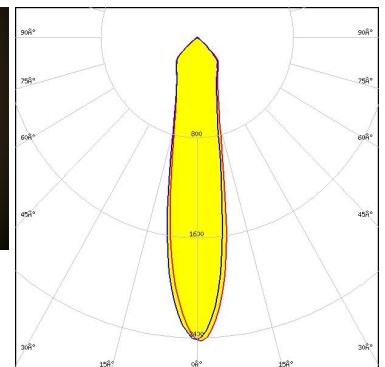
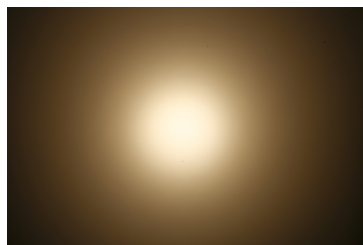

Light distribution files

### OPTICAL RESULTS (MEASURED):



**LED** WU-M-484  
**FWHM / FWTM** 25.0° / 91.0°  
**Efficiency** 88 %  
**Peak intensity** 1.8 cd/lm  
**LEDs/each optic** 1  
**Light colour/type** White  
**Required components:**  
 C13333\_MIRELLA-CL  
 TE Connectivity: OPTIC CLIP Z50 TYPE1 2213194-1

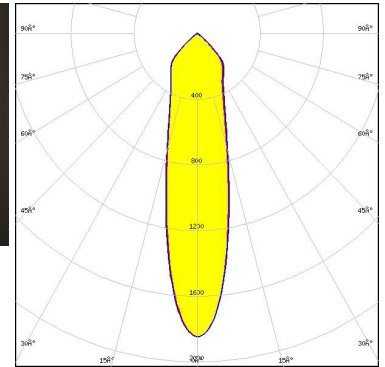
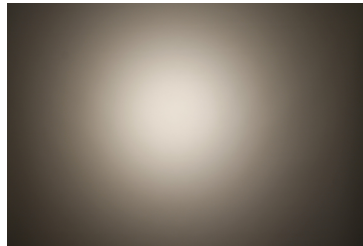

Light distribution files



**LED** WU-M-485  
**FWHM / FWTM** 27.0° / 81.0°  
**Efficiency** 93 %  
**Peak intensity** 1.9 cd/lm  
**LEDs/each optic** 1  
**Light colour/type** White  
**Required components:**  
 TE Connectivity: OPTIC CLIP Z50 TYPE1 2213194-1

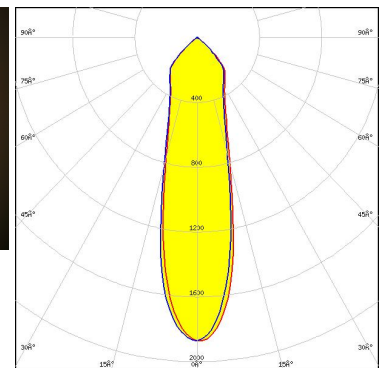
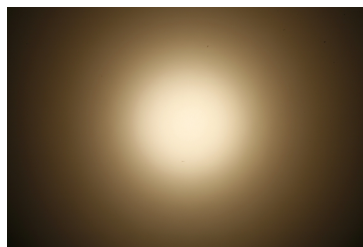

Light distribution files



**LED** WU-M-486  
**FWHM / FWTM** 26.0° / 91.0°  
**Efficiency** 93 %  
**Peak intensity** 1.9 cd/lm  
**LEDs/each optic** 1  
**Light colour/type** White  
**Required components:**  
 TE Connectivity: OPTIC CLIP Z50 TYPE1 2213194-1

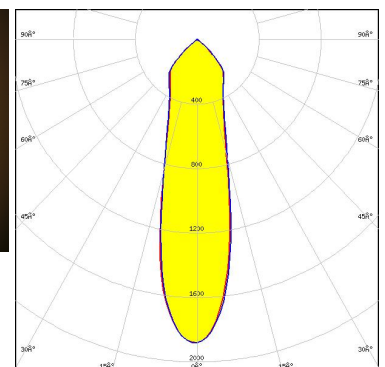
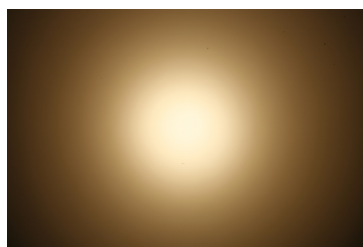

Light distribution files

### OPTICAL RESULTS (SIMULATED):



LED V10 Gen7  
FWHM / FWTM 17.0° / 32.0°  
Efficiency 94 %  
Peak intensity 4.3 cd/lm  
LEDs/each optic 1  
Light colour/type White  
Required components:  
C13658\_CLAMP-VERO13-18

Bender Wirth: 486 Typ L1

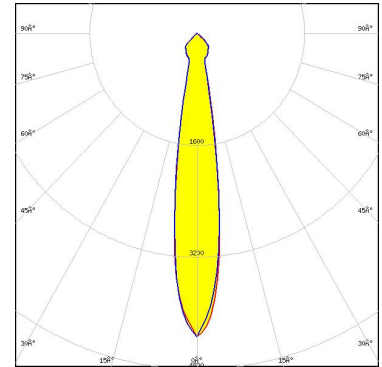

Light distribution files



LED V10 Gen7  
FWHM / FWTM 17.0° / 33.0°  
Efficiency 94 %  
Peak intensity 4.2 cd/lm  
LEDs/each optic 1  
Light colour/type White  
Required components:  
C13584\_CLAMP-VERO29

Bender Wirth: 486 Typ L1

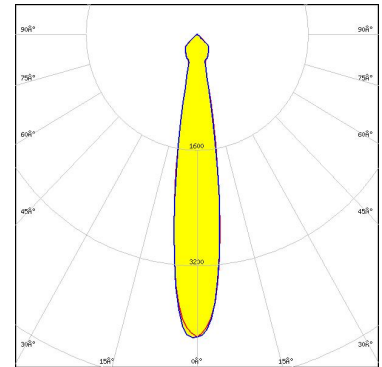

Light distribution files



LED V13 Gen7  
FWHM / FWTM 16.0° / 34.0°  
Efficiency 93 %  
Peak intensity 4.6 cd/lm  
LEDs/each optic 1  
Light colour/type White  
Required components:

IDEAL: 50-2103CT + 50-2100AN

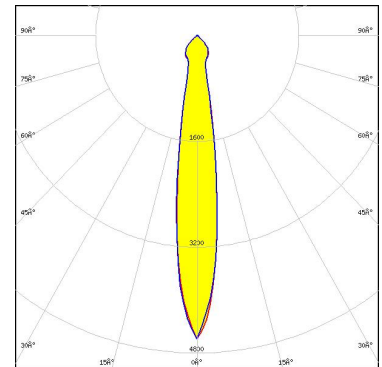

Light distribution files

### OPTICAL RESULTS (SIMULATED):



LED V22 Gen7  
FWHM / FWTM 21.0° / 74.0°  
Efficiency 94 %  
Peak intensity 3 cd/lm  
LEDs/each optic 1  
Light colour/type White  
Required components:

IDEAL: 50-2204-CT + 50-2100AN

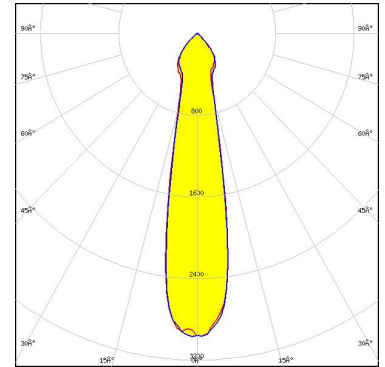

Light distribution files



LED CxM-14 (19x19)  
FWHM / FWTM 21.0° / 89.0°  
Efficiency 92 %  
Peak intensity 2.3 cd/lm  
LEDs/each optic 1  
Light colour/type White  
Required components:

C13658\_CLAMP-VERO13-18

Bender Wirth: 433 Typ L1

Light distribution files



LED CxM-9 (13.5x13.5)  
FWHM / FWTM 17.0° / 75.0°  
Efficiency 93 %  
Peak intensity 2.9 cd/lm  
LEDs/each optic 1  
Light colour/type White  
Required components:

C13658\_CLAMP-VERO13-18

Bender Wirth: 434 Typ L1

Light distribution files

#### OPTICAL RESULTS (SIMULATED):

 SEOL SEMICONDUCTOR	
LED	ZC12/18
FWHM / FWTM	21.0° / 89.0°
Efficiency	92 %
Peak intensity	2.3 cd/lm
LEDs/each optic	1
Light colour/type	White
Required components: C13658_CLAMP-VERO13-18	
Bender Wirth: 433 Typ L1	

 SEOL SEMICONDUCTOR	
LED	ZC4/6
FWHM / FWTM	17.0° / 75.0°
Efficiency	93 %
Peak intensity	2.9 cd/lm
LEDs/each optic	1
Light colour/type	White
Required components: C13658_CLAMP-VERO13-18	
Bender Wirth: 434 Typ L1	

### GENERAL INFORMATION:

NOTE: The typical beam angle will be changed by different color, chip size and chip position tolerance. The typical total beam angle is the full angle measured where the luminous intensity is half of the peak value.

Due to use of high power COB's with this product, special attention to proper thermal design is highly recommended. LEDiL has no liability for direct, indirect or consecutive damages arising from the LEDiL products being used outside of the recommended temperature range.

### MATERIALS:

As part of our continuous research and improvement processes, and to ensure the best possible quality and availability of our products, LEDiL reserves the right to change material grades without notice.

### PRODUCT DATA USER AGREEMENT AND DISCLAIMER:

The measured data in the provided downloadable LEDiL Product Datasheets and Mechanical 2D-Drawings is rounded and provided as reference for planning. LEDiL Oy's optical specifications have been verified by conducting performance testing of the products in accordance with the company's quality system. The reported data are averaged results of multiple measurements with typical variation. LEDiL Oy reserves the right to without prior notification make changes and improvements to its products.

LEDiL Oy assumes neither warranty, nor guarantee nor any other liability of any kind for the contents and correctness of the provided data. The provided data has been generated with highest diligence but the provided data may in reality not represent the complete possible variation range of all intrinsic parameters. Therefore, in certain cases a deviation from the provided data could occur.

LEDiL Oy reserves the right to undertake technical changes of its products without further notification which could lead to changes in the provided data. LEDiL Oy assumes no liability of any kind for the possible deviation from any provided data or any other damage resulting from the usage of the provided data.

The user agrees to this disclaimer and user agreement with the download or usage of the provided files.

#### LEDiL Oy

Joensuunkatu 7  
FI-24240 SALO  
Finland

#### LEDiL Inc.

228 West Page Street  
Suite D  
Sycamore IL 60178  
USA

#### Ledil Optics Technology (Shenzhen) Co., Ltd.

# 405 , Block B  
Casic Motor Building  
Shenzhen 518057  
P.R.CHINA

#### Local sales and technical support

[www.ledil.com/  
where\\_to\\_buy](http://www.ledil.com/where_to_buy)

#### Shipping locations

Poznan, Poland  
Hong Kong, China

#### Distribution Partners

[www.ledil.com/  
where\\_to\\_buy](http://www.ledil.com/where_to_buy)