

ANGELINA-W

~50° wide beam

SPECIFICATION:

Dimensions	Ø 82.0
Height	31 mm
Fastening	socket
ROHS compliant	yes ⓘ

MATERIALS:

Component	Type	Material	Colour	Finish	Coating
ANGELINA-W	Reflector	PC	metal		HMDS

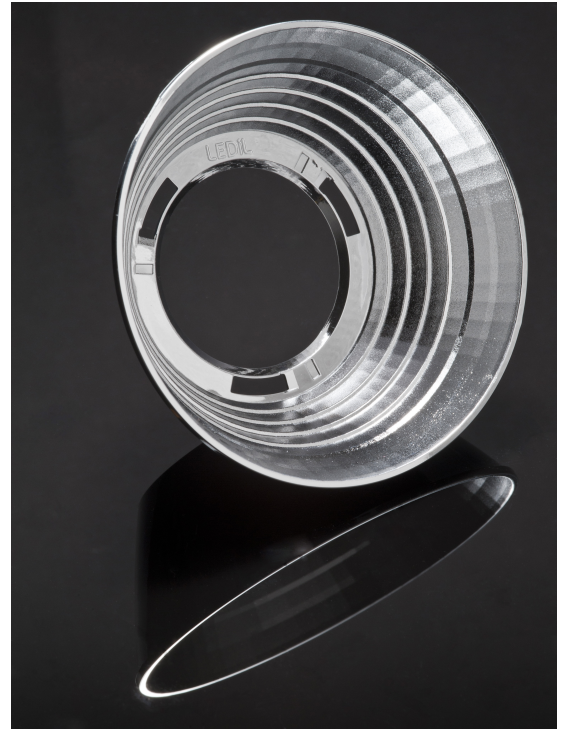

ORDERING INFORMATION:

Component	Qty in box	MOQ	MPQ	Box weight (kg)
F13402_ANGELINA-W » Box size: 480 x 280 x 300 mm	900	120	60	11.3

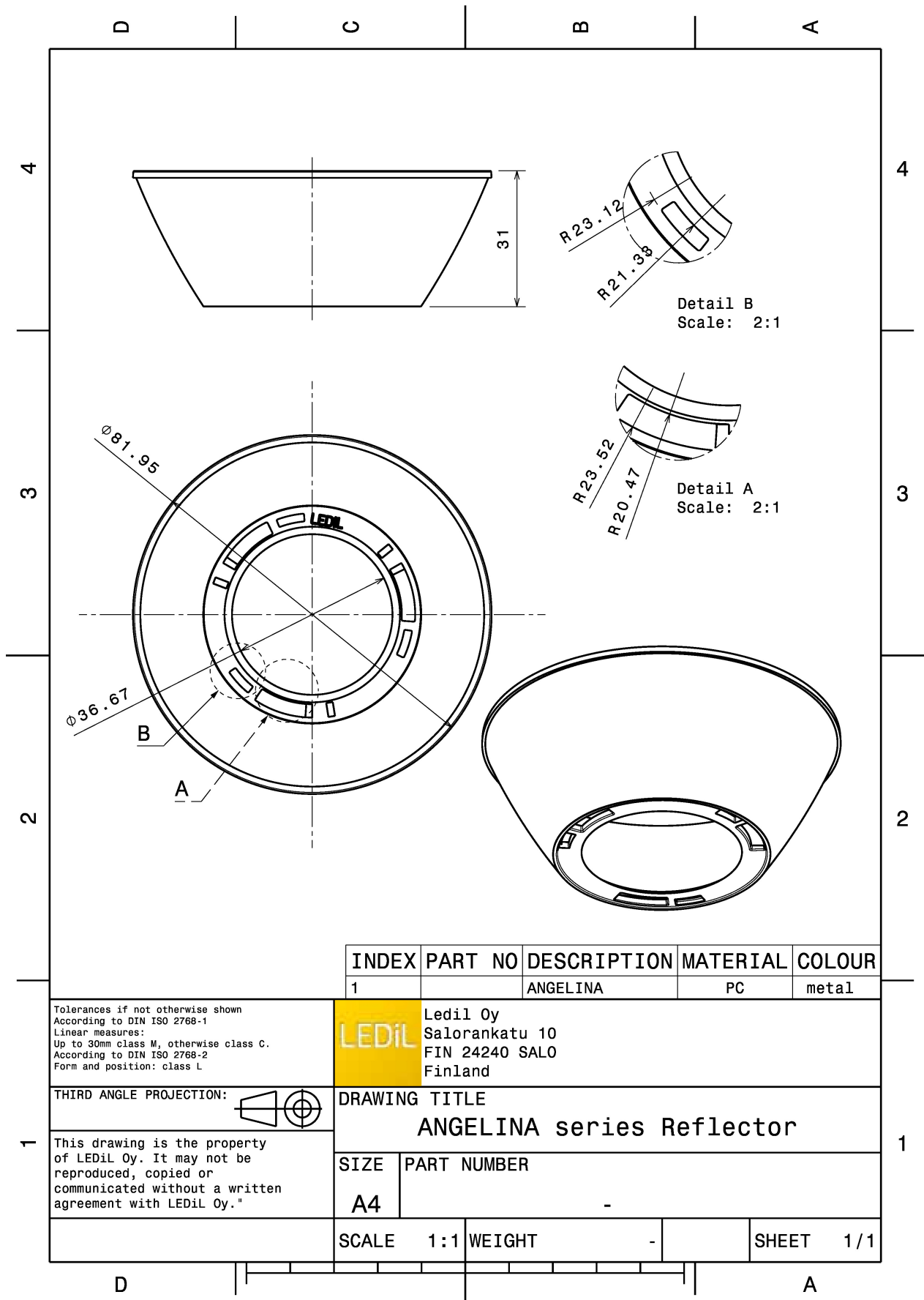

INDEX	PART NO	DESCRIPTION	MATERIAL	COLOUR
1		ANGELINA	PC	metal

Tolerances if not otherwise shown
According to DIN ISO 2768-1
Linear measures:
Up to 30mm class M, otherwise class C.
According to DIN ISO 2768-2
Form and position: class L

LEDiL Ledil Oy
Salorankatu 10
FIN 24240 SALO
Finland

THIRD ANGLE PROJECTION:

DRAWING TITLE
ANGELINA series Reflector

This drawing is the property of LEDiL Oy. It may not be reproduced, copied or communicated without a written agreement with LEDiL Oy."

SIZE	PART NUMBER
A4	-

SCALE	1:1	WEIGHT	-	SHEET	1/1
-------	-----	--------	---	-------	-----

See also our general installation guide: www.ledil.com/installation_guide

OPTICAL RESULTS (MEASURED):



LED BXRA ES Rectangle
FWHM / FWTM 43.0° / 95.0°
Efficiency 93 %
Peak intensity 1.2 cd/lm
LEDs/each optic 1
Light colour/type White
Required components:
 IDEAL: 50-2100BL + 50-2100AN

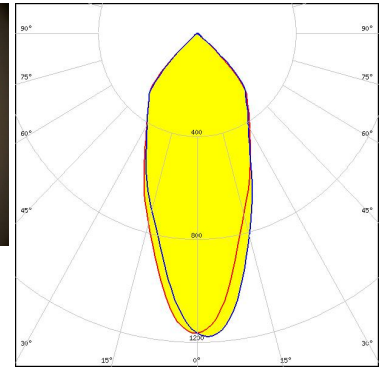
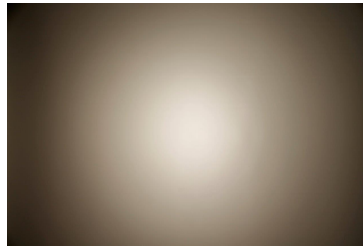

Light distribution files



LED V10 Gen7
FWHM / FWTM 47.0° / 98.0°
Efficiency 92 %
Peak intensity 1.1 cd/lm
LEDs/each optic 1
Light colour/type White
Required components:
 C13658_CLAMP-VERO13-18
 Bender Wirth: 434 Typ L1

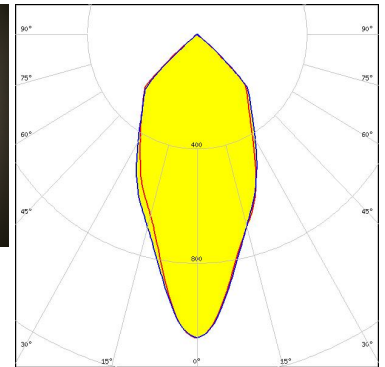
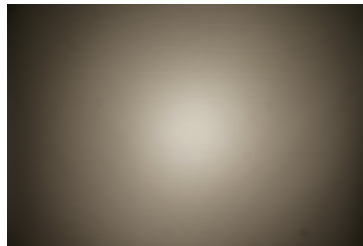

Light distribution files



LED V10 Gen7
FWHM / FWTM 54.0° / 100.0°
Efficiency 87 %
Peak intensity 0.9 cd/lm
LEDs/each optic 1
Light colour/type White
Required components:
 C13658_CLAMP-VERO13-18
 F13671_ANGE-RZ-LENS
 Bender Wirth: 434 Typ L1

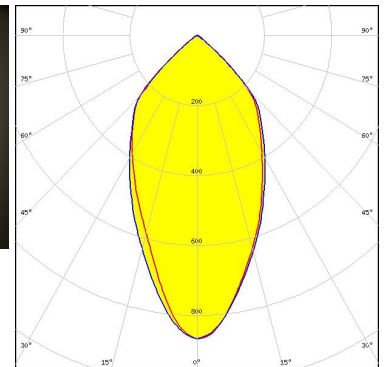
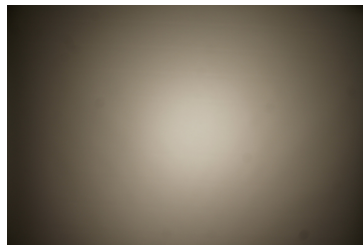

Light distribution files

OPTICAL RESULTS (MEASURED):



LED V13 Gen7
 FWHM / FWTM 50.0° / 98.0°
 Efficiency 92 %
 Peak intensity 1 cd/lm
 LEDs/each optic 1
 Light colour/type White

Required components:

TE Connectivity: 2213254-2 + OPTIC CLIP Z50 TYPE1 2213194-1

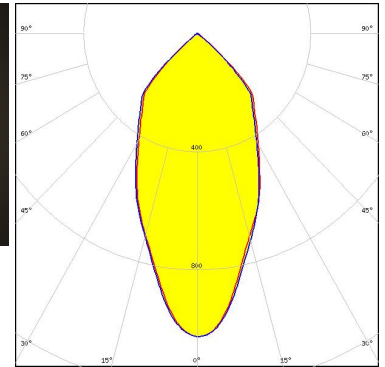
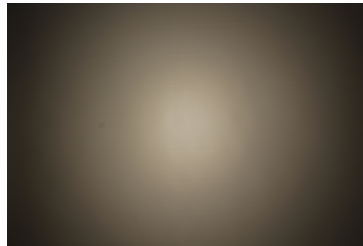

Light distribution files



LED V15 Gen6
 FWHM / FWTM 51.0° / 102.0°
 Efficiency 93 %
 Peak intensity 1.1 cd/lm
 LEDs/each optic 1
 Light colour/type White

Required components:

C13658_CLAMP-VERO13-18

Bender Wirth: 456 Typ L2

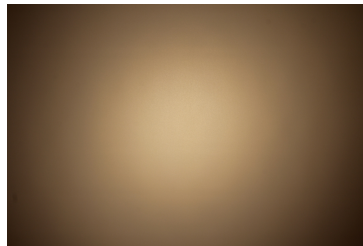

Light distribution files



LED V22 Gen6
 FWHM / FWTM 57.0° / 98.0°
 Efficiency 92 %
 Peak intensity 0.9 cd/lm
 LEDs/each optic 1
 Light colour/type White

Required components:

IDEAL: 50-2204-CT + 50-2100AN

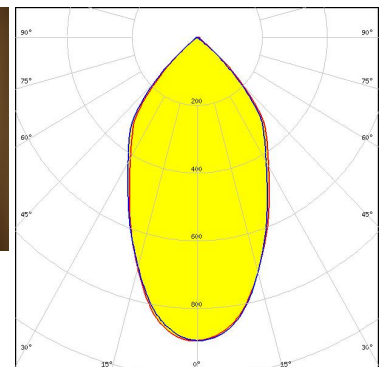

Light distribution files

OPTICAL RESULTS (MEASURED):



LED Vero SE 13
FWHM / FWTM 51.0° / 99.0°
Efficiency 93 %
Peak intensity 1 cd/lm
LEDs/each optic 1
Light colour/type White
Required components:
 C16402_CLAMP-VEROSE-13-18

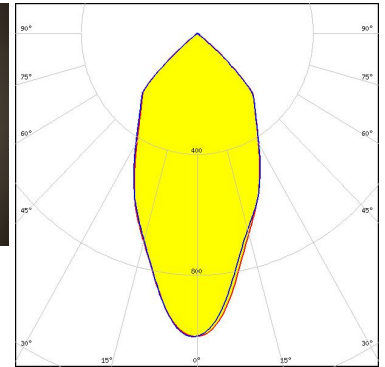
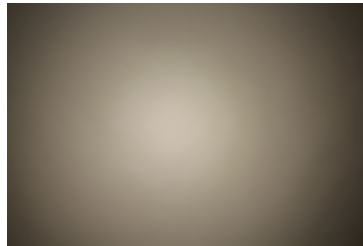

Light distribution files



LED Vero SE 18
FWHM / FWTM 57.0° / 100.0°
Efficiency 93 %
Peak intensity 0.9 cd/lm
LEDs/each optic 1
Light colour/type White
Required components:
 C16402_CLAMP-VEROSE-13-18

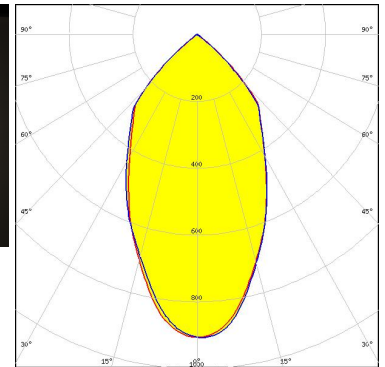
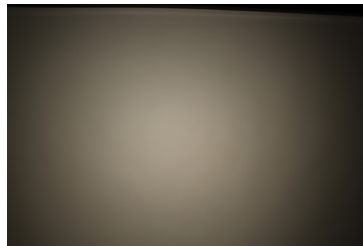

Light distribution files



LED VERO13
FWHM / FWTM 49.0° / 97.0°
Efficiency 92 %
Peak intensity 1.1 cd/lm
LEDs/each optic 1
Light colour/type White
Required components:
 C13658_CLAMP-VERO13-18

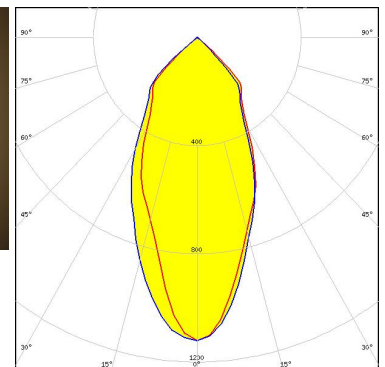
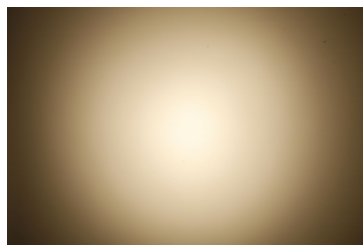

Light distribution files

OPTICAL RESULTS (MEASURED):



LED VERO13
FWHM / FWTM 53.0° / 101.0°
Efficiency 89 %
Peak intensity 0.9 cd/lm
LEDs/each optic 1
Light colour/type White
Required components:
 C13658_CLAMP-VERO13-18
 F13671_ANGE-RZ-LENS

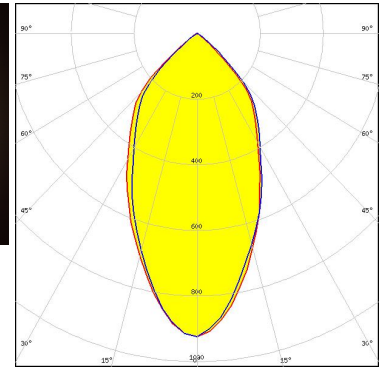

Light distribution files



LED VERO18
FWHM / FWTM 55.0° / 98.0°
Efficiency 92 %
Peak intensity 1 cd/lm
LEDs/each optic 1
Light colour/type White
Required components:
 C13658_CLAMP-VERO13-18

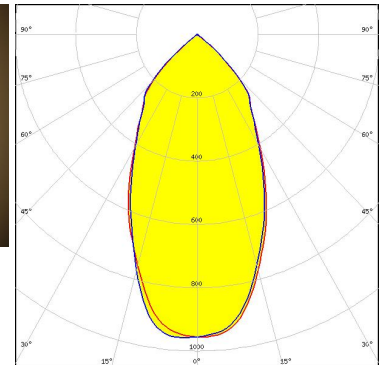
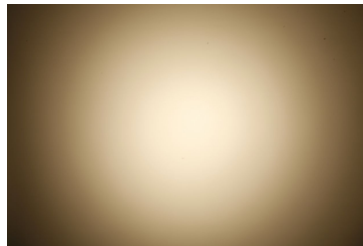

Light distribution files



LED VERO18
FWHM / FWTM 56.0° / 101.0°
Efficiency 90 %
Peak intensity 0.9 cd/lm
LEDs/each optic 1
Light colour/type White
Required components:
 C13658_CLAMP-VERO13-18
 F13671_ANGE-RZ-LENS

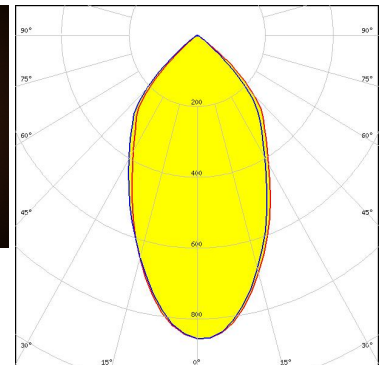
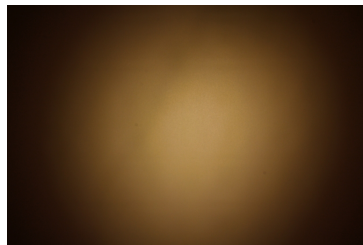

Light distribution files

OPTICAL RESULTS (MEASURED):



LED VERO29
FWHM / FWTM 64.0° / 102.0°
Efficiency 89 %
Peak intensity 0.8 cd/lm
LEDs/each optic 1
Light colour/type White
Required components:
 C13584_CLAMP-VERO29

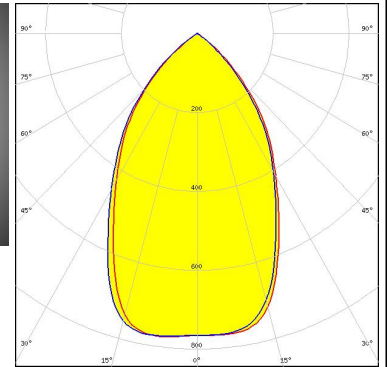

Light distribution files



LED VERO29
FWHM / FWTM 73.0° / 106.0°
Efficiency 88 %
Peak intensity 0.7 cd/lm
LEDs/each optic 1
Light colour/type White
Required components:
 C13584_CLAMP-VERO29
 F13671_ANGE-RZ-LENS

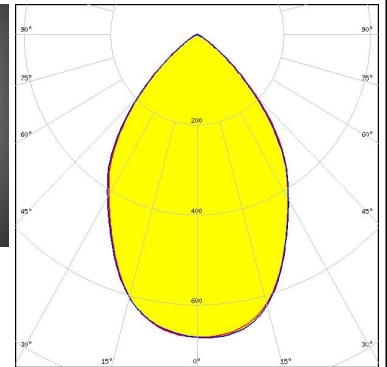

Light distribution files



LED Vesta TW 15mm DP
FWHM / FWTM 67.0° / 104.0°
Efficiency 88 %
Peak intensity 0.7 cd/lm
LEDs/each optic 1
Light colour/type Tunable White
Required components:
 C13658_CLAMP-VERO13-18
 F13671_ANGE-RZ-LENS
 Bender Wirth: 482 Typ L2

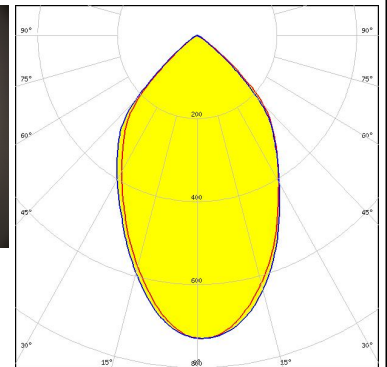
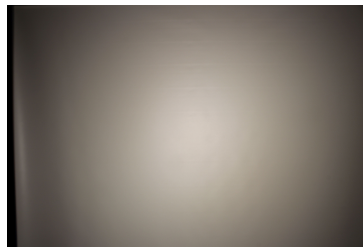

Light distribution files

OPTICAL RESULTS (MEASURED):



LED Vesta TW 15mm DP
FWHM / FWTM 62.0° / 101.0°
Efficiency 93 %
Peak intensity 0.9 cd/lm
LEDs/each optic 1
Light colour/type Tunable White
Required components:
 C13658_CLAMP-VERO13-18
 Bender Wirth: 482 Typ L2

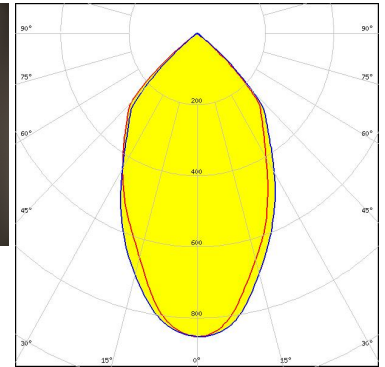
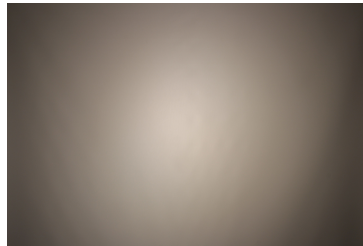

Light distribution files



LED Vesta TW 18mm (31W) DP
FWHM / FWTM 66.0° / 103.0°
Efficiency 88 %
Peak intensity 0.7 cd/lm
LEDs/each optic 1
Light colour/type Tunable White
Required components:
 C13584_CLAMP-VERO29
 F13671_ANGE-RZ-LENS
 Bender Wirth: 483 Typ L3

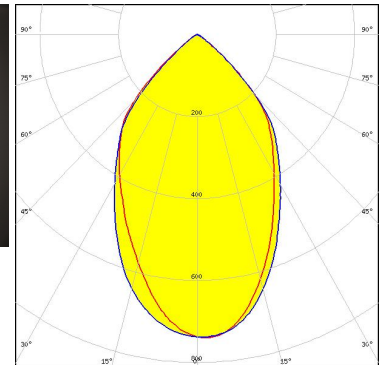
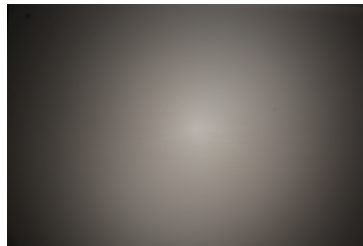

Light distribution files



LED Vesta TW 18mm (31W) DP
FWHM / FWTM 63.0° / 101.0°
Efficiency 93 %
Peak intensity 0.8 cd/lm
LEDs/each optic 1
Light colour/type Tunable White
Required components:
 C13584_CLAMP-VERO29
 Bender Wirth: 483 Typ L3

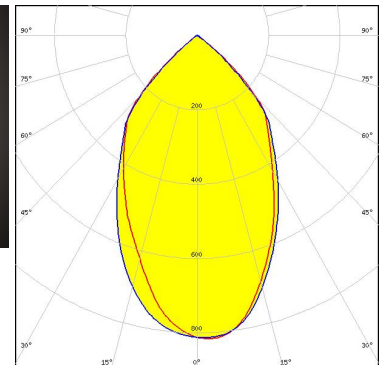
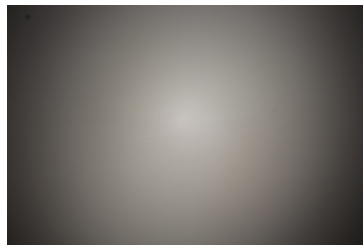

Light distribution files

OPTICAL RESULTS (MEASURED):



LED Vesta TW 22mm DP
FWHM / FWTM 65.0° / 102.0°
Efficiency 92 %
Peak intensity 0.8 cd/lm
LEDs/each optic 1
Light colour/type Tunable White
Required components:
 C13584_CLAMP-VERO29
 Bender Wirth: 494 Typ L3

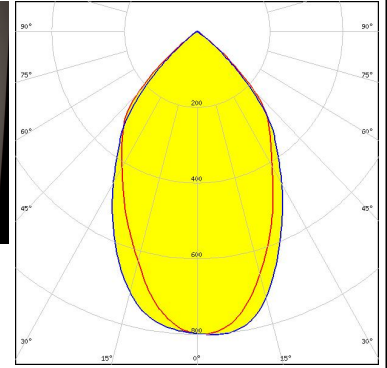

Light distribution files



LED Vesta TW 22mm DP
FWHM / FWTM 67.0° / 103.0°
Efficiency 88 %
Peak intensity 0.7 cd/lm
LEDs/each optic 1
Light colour/type Tunable White
Required components:
 C13584_CLAMP-VERO29
 F13671_ANGE-RZ-LENS
 Bender Wirth: 494 Typ L3

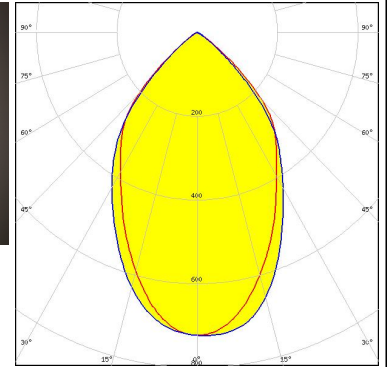

Light distribution files

CITIZEN

LED CLL02x/CLU02x (LES10)
FWHM / FWTM 45.0° / 98.0°
Efficiency 93 %
Peak intensity 1.1 cd/lm
LEDs/each optic 1
Light colour/type White
Required components:
 C13658_CLAMP-VERO13-18
 Bender Wirth: 434 Typ L1

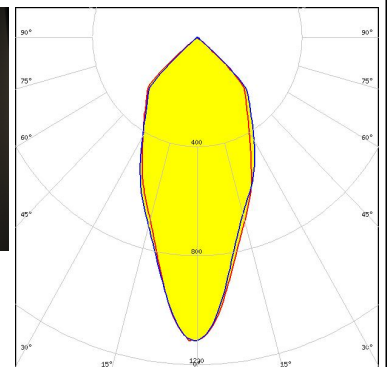
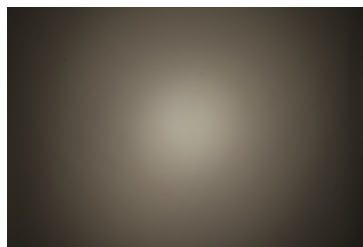

Light distribution files

OPTICAL RESULTS (MEASURED):

CITIZEN

LED CLL03x/CLU03x
 FWHM / FWTM 48.0° / 97.0°
 Efficiency 94 %
 Peak intensity 1.1 cd/lm
 LEDs/each optic 1
 Light colour/type White

Required components:

TE Connectivity: 2213254-2 + OPTIC CLIP Z50 TYPE1 2213194-1

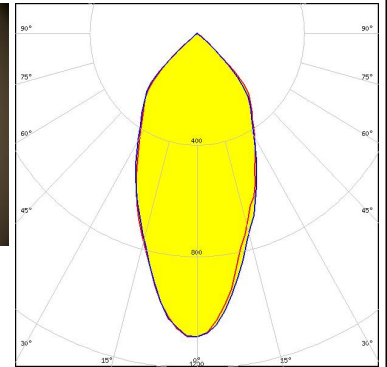
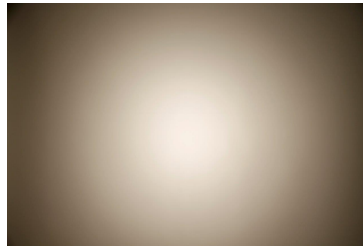

Light distribution files

CITIZEN

LED CLL03x/CLU03x
 FWHM / FWTM 57.0° / 98.0°
 Efficiency 94 %
 Peak intensity 0.9 cd/lm
 LEDs/each optic 1
 Light colour/type White

Required components:

C16791_CLAMP-Z45-A

TE Connectivity: 2325807-3

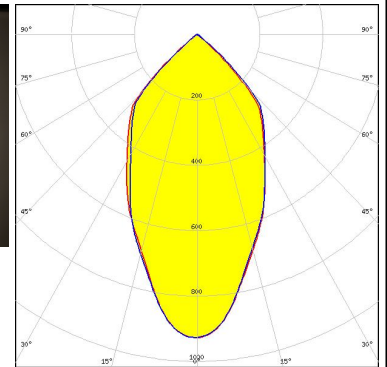
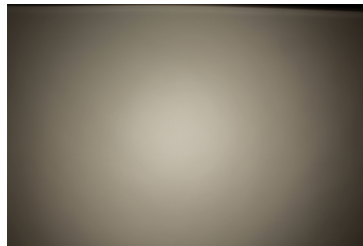

Light distribution files

CITIZEN

LED CLL03x/CLU03x
 FWHM / FWTM 52.0° / 98.0°
 Efficiency 92 %
 Peak intensity 1 cd/lm
 LEDs/each optic 1
 Light colour/type White

Required components:

C13658_CLAMP-VERO13-18

Bender Wirth: 433 Typ L1

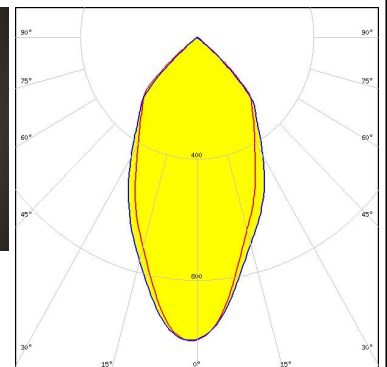
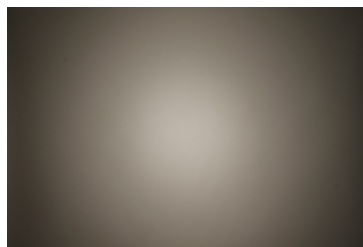

Light distribution files

OPTICAL RESULTS (MEASURED):

CITIZEN

LED CLL03x/CLU03x
 FWHM / FWTM 60.0° / 101.0°
 Efficiency 89 %
 Peak intensity 0.8 cd/lm
 LEDs/each optic 1
 Light colour/type White
 Required components:
 C16791_CLAMP-Z45-A
 F13671_ANGE-RZ-LENS
 TE Connectivity: 2325807-3

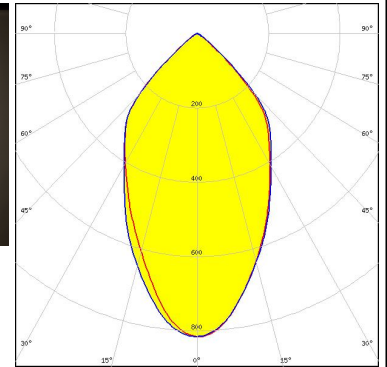

Light distribution files

CITIZEN

LED CLL03x/CLU03x
 FWHM / FWTM 43.0° / 94.0°
 Efficiency 93 %
 Peak intensity 1.2 cd/lm
 LEDs/each optic 1
 Light colour/type White
 Required components:
 IDEAL: 50-2103CT + 50-2100AN

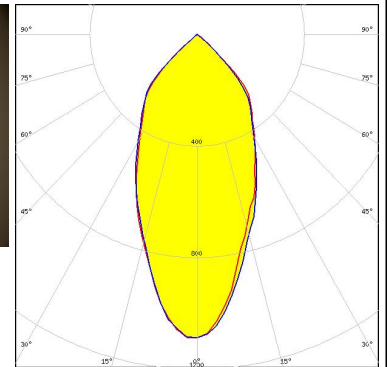
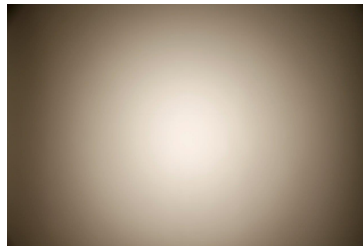

Light distribution files

CITIZEN

LED CLL04x/CLU04x
 FWHM / FWTM 43.0° / 96.0°
 Efficiency 91 %
 Peak intensity 1.1 cd/lm
 LEDs/each optic 1
 Light colour/type White
 Required components:
 IDEAL: 50-2204-CT + 50-2100AN

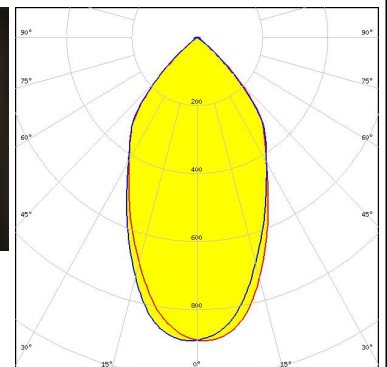
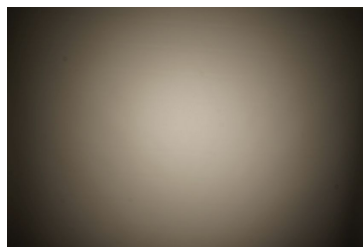

Light distribution files

OPTICAL RESULTS (MEASURED):

CITIZEN

LED CLL04x/CLU04x
FWHM / FWTM 54.0° / 97.0°
Efficiency 92 %
Peak intensity 1 cd/lm
LEDs/each optic 1
Light colour/type White
Required components:
C13584_CLAMP-VERO29
Bender Wirth: 431 Typ L3

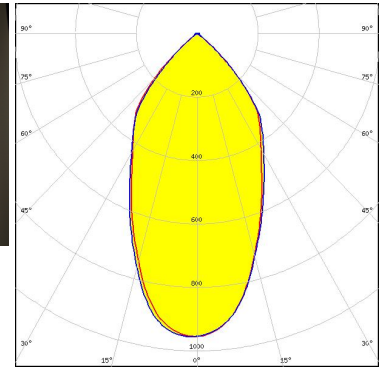
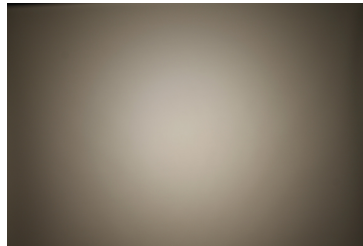

Light distribution files

CITIZEN

LED CLU700/701/702/703
FWHM / FWTM 42.0° / 97.0°
Efficiency 92 %
Peak intensity 1.2 cd/lm
LEDs/each optic 1
Light colour/type White
Required components:
C13658_CLAMP-VERO13-18
Bender Wirth: 434 Typ L1

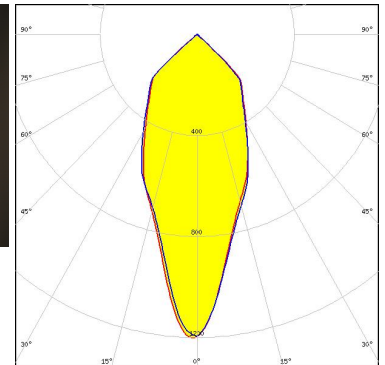
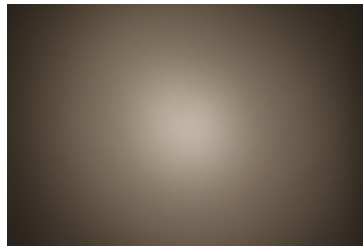

Light distribution files

CITIZEN

LED CLU720/721/723
FWHM / FWTM 45.0° / 97.0°
Efficiency 94 %
Peak intensity 1.1 cd/lm
LEDs/each optic 1
Light colour/type White
Required components:
TE Connectivity: 2213254-2 + OPTIC CLIP Z50 TYPE1 2213194-1

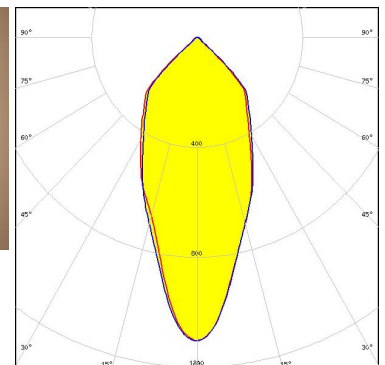
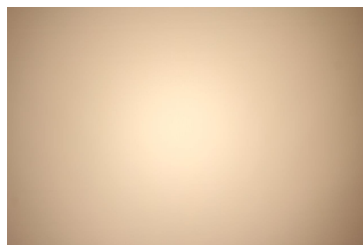

Light distribution files

OPTICAL RESULTS (MEASURED):

CITIZEN

LED CLU720/721/723
 FWHM / FWTM 38.0° / 94.0°
 Efficiency 93 %
 Peak intensity 1.2 cd/lm
 LEDs/each optic 1
 Light colour/type White
 Required components:
 IDEAL: 50-2103CT + 50-2100AN

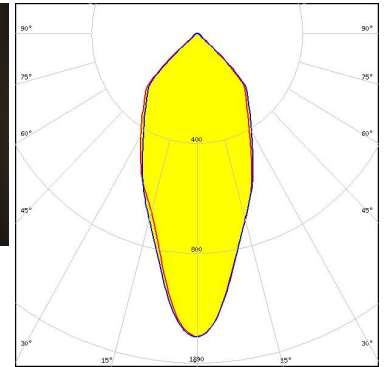

Light distribution files

CITIZEN

LED CLU720/721/723
 FWHM / FWTM 48.0° / 98.0°
 Efficiency 92 %
 Peak intensity 1.7 cd/lm
 LEDs/each optic 1
 Light colour/type White
 Required components:
 C13658_CLAMP-VERO13-18

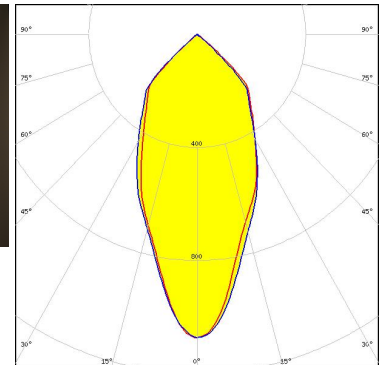
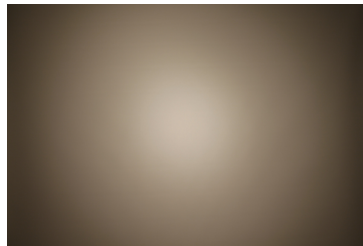

Light distribution files

CITIZEN

LED CLU730/731/733
 FWHM / FWTM 56.0° / 96.0°
 Efficiency 91 %
 Peak intensity 1.1 cd/lm
 LEDs/each optic 1
 Light colour/type White
 Required components:
 IDEAL: 50-2204-CT + 50-2100AN

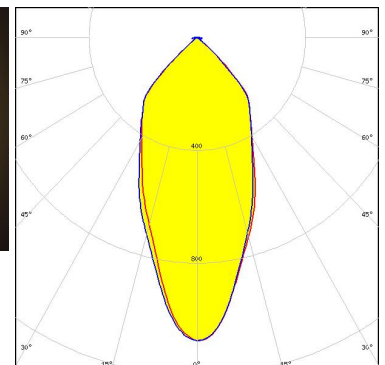
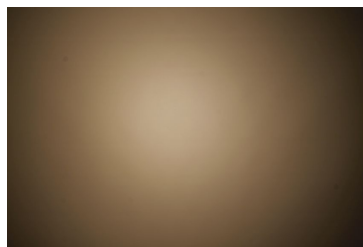

Light distribution files

OPTICAL RESULTS (MEASURED):



LED CMA1840
 FWHM / FWTM 53.0° / 100.0°
 Efficiency 95 %
 Peak intensity 1 cd/lm
 LEDs/each optic 1
 Light colour/type White
 Required components:
 C14123_CLAMP-CXA15-18

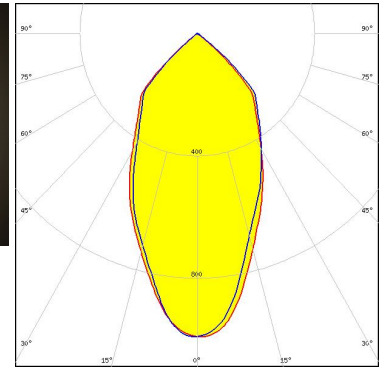
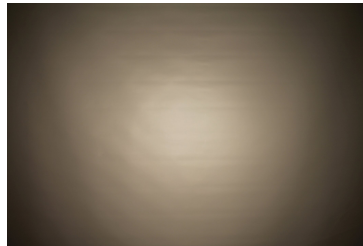

Light distribution files



LED CMA2550
 FWHM / FWTM 57.0° / 100.0°
 Efficiency 94 %
 Peak intensity 0.9 cd/lm
 LEDs/each optic 1
 Light colour/type White
 Required components:
 C14036_CLAMP_CXA25-30

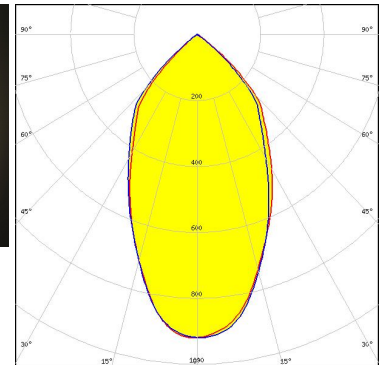
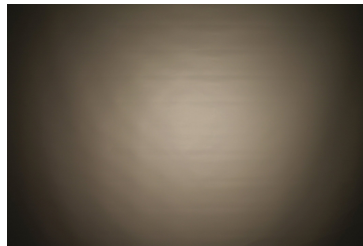

Light distribution files



LED CMA3090
 FWHM / FWTM 60.0° / 100.0°
 Efficiency 95 %
 Peak intensity 0.8 cd/lm
 LEDs/each optic 1
 Light colour/type White
 Required components:
 C14036_CLAMP_CXA25-30

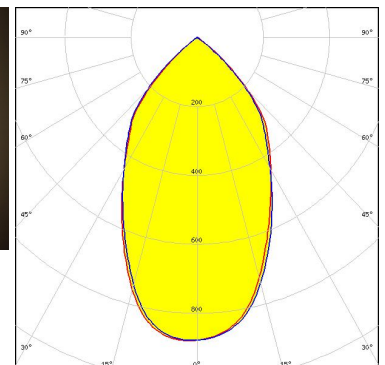
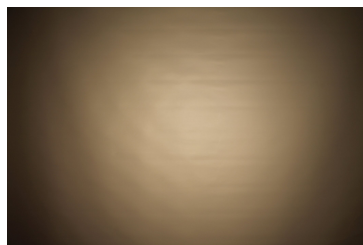

Light distribution files

OPTICAL RESULTS (MEASURED):



LED CMT14xx
FWHM / FWTM 47.0° / 98.0°
Efficiency 94 %
Peak intensity 1.1 cd/lm
LEDs/each optic 1
Light colour/type White
Required components:
 C13658_CLAMP-VERO13-18
 Bender Wirth: 434 Typ L1

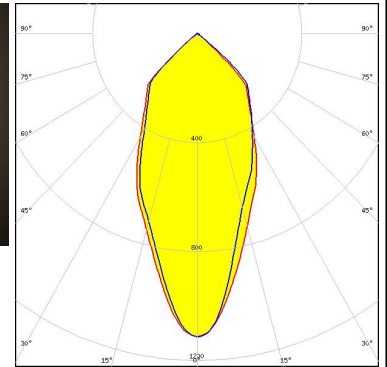

Light distribution files



LED CMT19xx
FWHM / FWTM 51.0° / 99.0°
Efficiency 94 %
Peak intensity 1 cd/lm
LEDs/each optic 1
Light colour/type White
Required components:
 C13658_CLAMP-VERO13-18
 Bender Wirth: 477 Typ L1

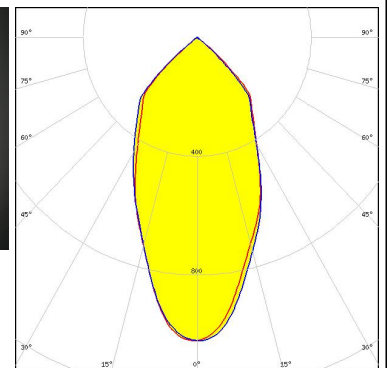
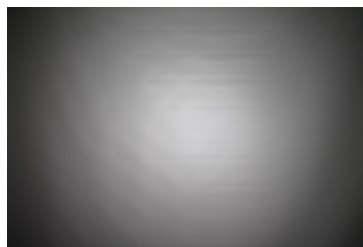

Light distribution files



LED CMT28xx
FWHM / FWTM 58.0° / 100.0°
Efficiency 94 %
Peak intensity 0.9 cd/lm
LEDs/each optic 1
Light colour/type White
Required components:
 C13584_CLAMP-VERO29
 Bender Wirth: 471 Typ L3

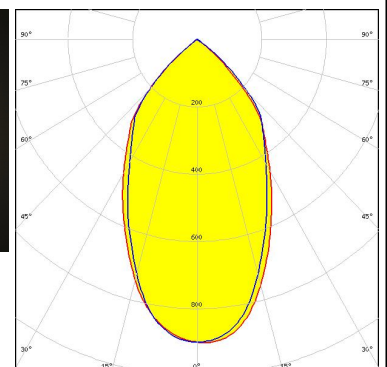
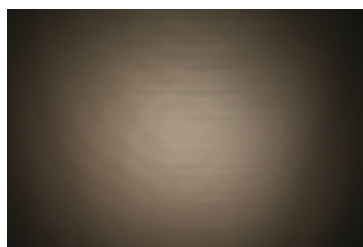

Light distribution files

OPTICAL RESULTS (MEASURED):



LED CXA/B 15xx
 FWHM / FWTM 42.0° / 97.0°
 Efficiency 93 %
 Peak intensity 1.2 cd/lm
 LEDs/each optic 1
 Light colour/type White
 Required components:
 C13658_CLAMP-VERO13-18
 Bender Wirth: 441 Typ L1

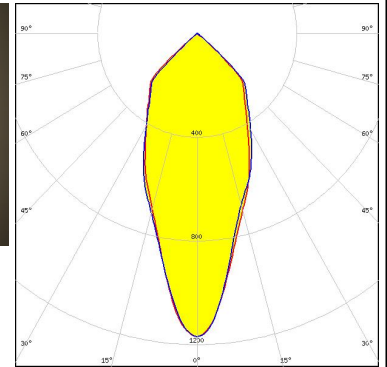
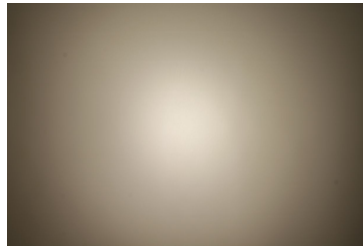

Light distribution files



LED CXA/B 15xx
 FWHM / FWTM 46.0° / 99.0°
 Efficiency 93 %
 Peak intensity 1.2 cd/lm
 LEDs/each optic 1
 Light colour/type White
 Required components:
 C14123_CLAMP-CXA15-18

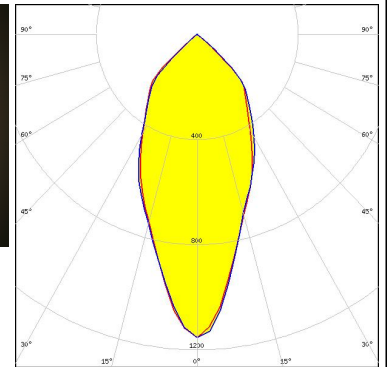
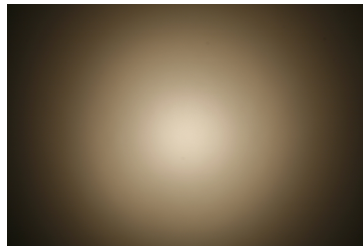

Light distribution files



LED CXA/B 1816 & CXA/B 1820 & CXA 1850
 FWHM / FWTM 39.0° / 94.0°
 Efficiency 94 %
 Peak intensity 1.3 cd/lm
 LEDs/each optic 1
 Light colour/type White
 Required components:
 IDEAL: 50-2101CR + 50-2100AN

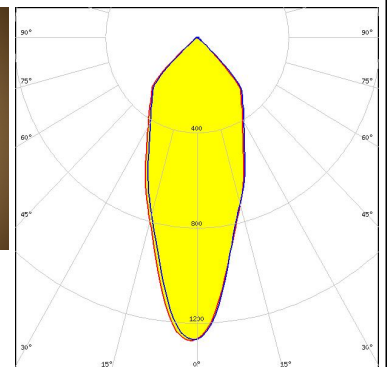
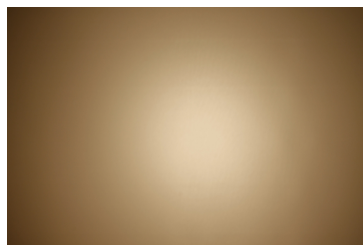

Light distribution files

OPTICAL RESULTS (MEASURED):



LED CXA/B 1816 & CXA/B 1820 & CXA 1850
FWHM / FWMTM 50.0° / 100.0°
Efficiency 94 %
Peak intensity 1.1 cd/lm
LEDs/each optic 1
Light colour/type White
Required components:
C14123_CLAMP-CXA15-18

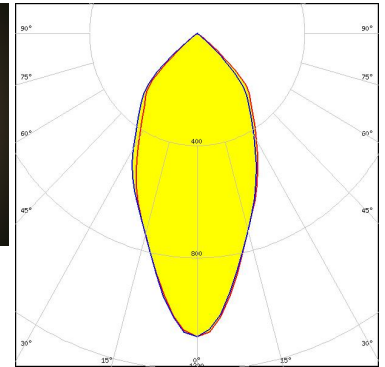
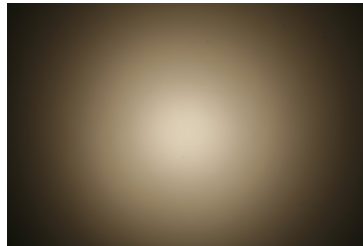

Light distribution files



LED CXA/B 1816 & CXA/B 1820 & CXA 1850
FWHM / FWMTM 49.0° / 98.0°
Efficiency 92 %
Peak intensity 1 cd/lm
LEDs/each optic 1
Light colour/type White
Required components:
TE Connectivity: 2213401-2 + OPTIC CLIP Z50 TYPE1 2213194-1

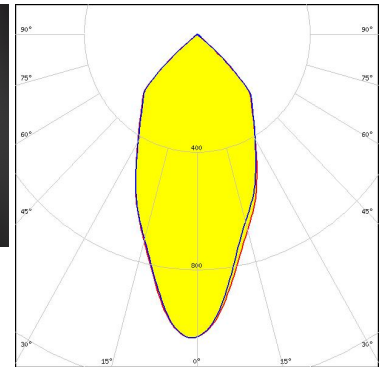
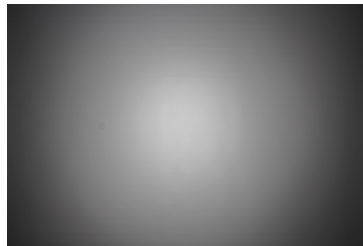

Light distribution files



LED CXA/B 1816 & CXA/B 1820 & CXA 1850
FWHM / FWMTM 50.0° / 98.0°
Efficiency 92 %
Peak intensity 1 cd/lm
LEDs/each optic 1
Light colour/type White
Required components:
C13658_CLAMP-VERO13-18
Bender Wirth: 437 Typ L1

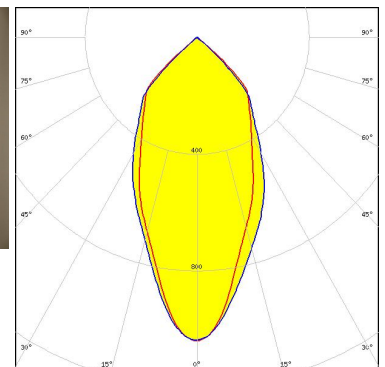
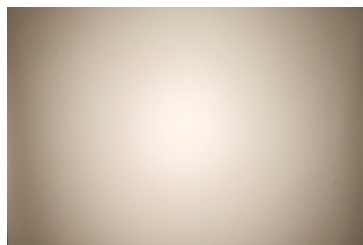

Light distribution files

OPTICAL RESULTS (MEASURED):



LED CXA/B 25xx
 FWHM / FWTM 56.0° / 100.0°
 Efficiency 93 %
 Peak intensity 0.9 cd/lm
 LEDs/each optic 1
 Light colour/type White
 Required components:
 C14036_CLAMP_CXA25-30

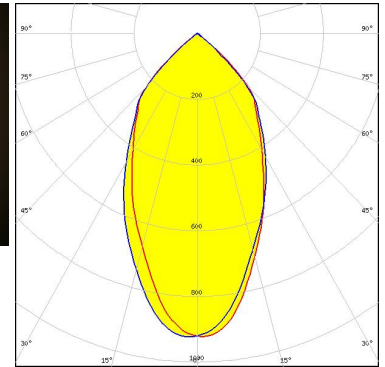
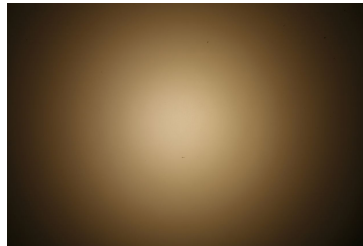

Light distribution files



LED CXA/B 25xx
 FWHM / FWTM 47.0° / 96.0°
 Efficiency 94 %
 Peak intensity 1.1 cd/lm
 LEDs/each optic 1
 Light colour/type White
 Required components:
 IDEAL: 50-2102CR + 50-2100AN

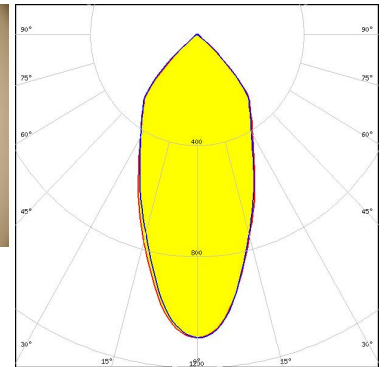
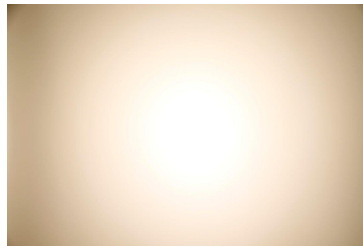

Light distribution files



LED CXA/B 30xx
 FWHM / FWTM 61.0° / 101.0°
 Efficiency 92 %
 Peak intensity 0.8 cd/lm
 LEDs/each optic 1
 Light colour/type White
 Required components:
 C14036_CLAMP_CXA25-30

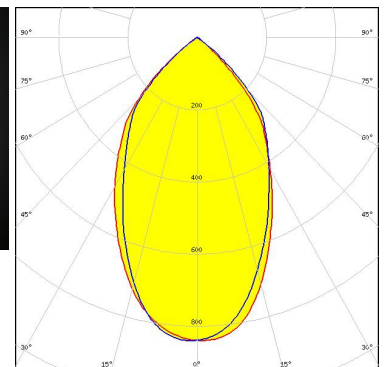
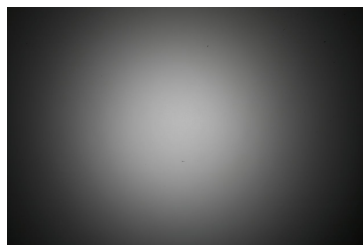

Light distribution files

OPTICAL RESULTS (MEASURED):



LED CXA/B 30xx
 FWHM / FWTM 52.0° / 97.0°
 Efficiency 93 %
 Peak intensity 1 cd/lm
 LEDs/each optic 1
 Light colour/type White
 Required components:
 IDEAL: 50-2234C + 50-2100AN

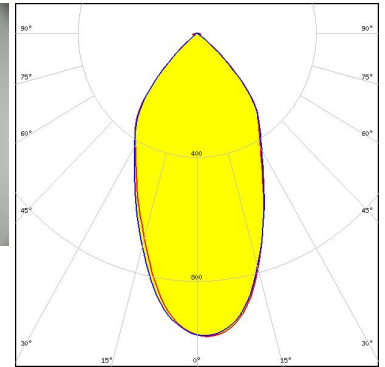
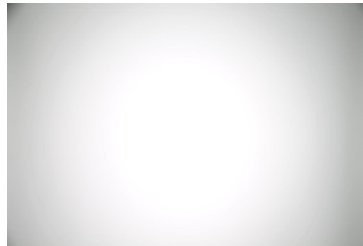

Light distribution files



LED CXA/B 3590
 FWHM / FWTM 66.0° / 103.0°
 Efficiency 93 %
 Peak intensity 0.8 cd/lm
 LEDs/each optic 1
 Light colour/type White
 Required components:
 IDEAL: 50-2303CR + 50-2300AN

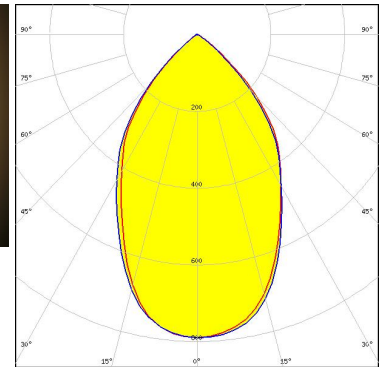
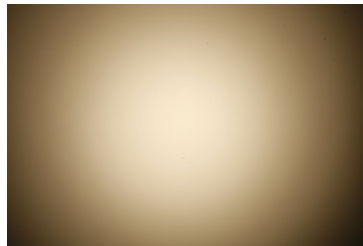

Light distribution files



LED CHI3030 19W
 FWHM / FWTM 54.0° / 100.0°
 Efficiency 88 %
 Peak intensity 0.9 cd/lm
 LEDs/each optic 1
 Light colour/type White
 Required components:
 C13584_CLAMP-VERO29
 F13671_ANGE-RZ-LENS
 Bender Wirth: 468 Typ L3

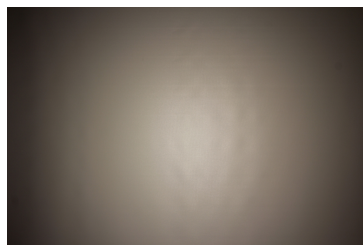

Light distribution files

OPTICAL RESULTS (MEASURED):

EVERLIGHT

LED CHI3030 29W
FWHM / FWTM 62.0° / 104.0°
Efficiency 87 %
Peak intensity 0.9 cd/lm
LEDs/each optic 1
Light colour/type White

Required components:

C13584_CLAMP-VERO29
F13671_ANGE-RZ-LENS
Bender Wirth: 468 Typ L3

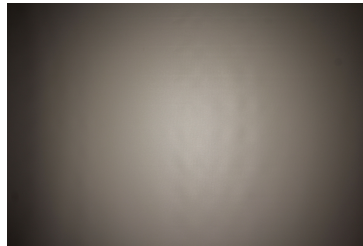

Light distribution files

inventronics

LED PrevaLED Core AC (LEP-2000)
FWHM / FWTM 49.0° / 96.0°
Efficiency 93 %
Peak intensity 1.1 cd/lm
LEDs/each optic 1
Light colour/type White

Required components:

TE Connectivity: OPTIC CLIP Z50 TYPE1 2213194-1

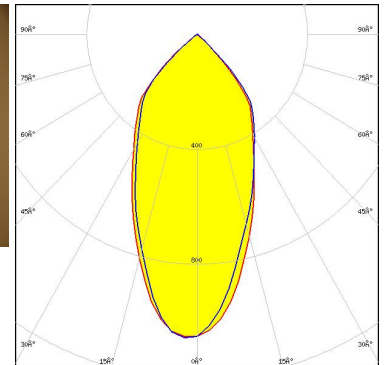

Light distribution files

inventronics

LED PrevaLED Core AC (LEP-800)
FWHM / FWTM 40.0° / 94.0°
Efficiency 93 %
Peak intensity 1.3 cd/lm
LEDs/each optic 1
Light colour/type White

Required components:

TE Connectivity: OPTIC CLIP Z50 TYPE1 2213194-1

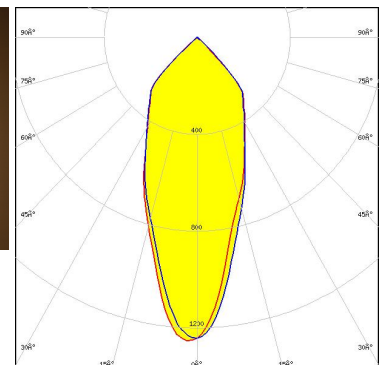

Light distribution files

OPTICAL RESULTS (MEASURED):

inventronics

LED PrevaLED Core G7 L15 H1
 FWHM / FWTM 60.0° / 101.0°
 Efficiency 90 %
 Peak intensity 0.8 cd/lm
 LEDs/each optic 1
 Light colour/type White
 Required components:
 C16685_CLAMP-PRV-A
 F13671_ANGE-RZ-LENS

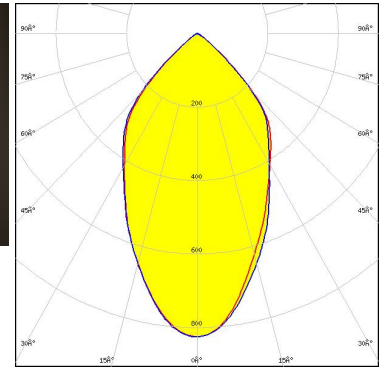

Light distribution files

inventronics

LED PrevaLED Core G7 L15 H1
 FWHM / FWTM 57.0° / 98.0°
 Efficiency 93 %
 Peak intensity 0.9 cd/lm
 LEDs/each optic 1
 Light colour/type White
 Required components:
 C16685_CLAMP-PRV-A

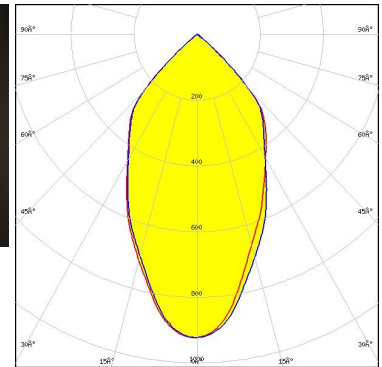
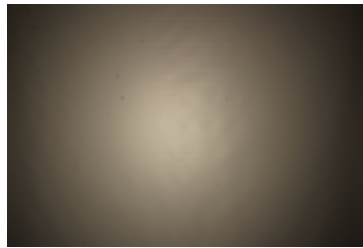

Light distribution files

inventronics

LED PrevaLED Core Z3 LES19
 FWHM / FWTM 50.0° / 98.0°
 Efficiency 94 %
 Peak intensity 1 cd/lm
 LEDs/each optic 1
 Light colour/type White
 Required components:
 TE Connectivity: OPTIC CLIP Z50 TYPE1 2213194-1

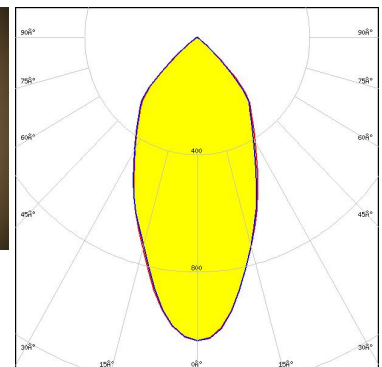
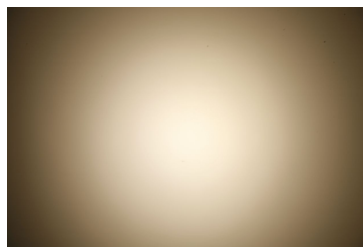

Light distribution files

OPTICAL RESULTS (MEASURED):

inventronics

LED PrevaLED Core Z3 LES23
 FWHM / FWTM 55.0° / 99.0°
 Efficiency 94 %
 Peak intensity 1 cd/lm
 LEDs/each optic 1
 Light colour/type White
 Required components:
 TE Connectivity: OPTIC CLIP Z50 TYPE1 2213194-1

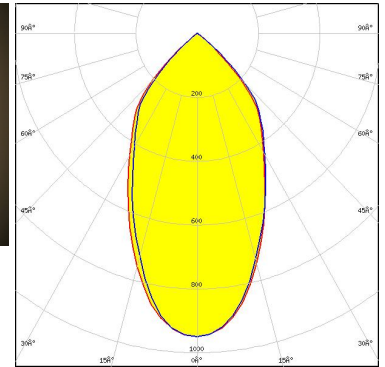
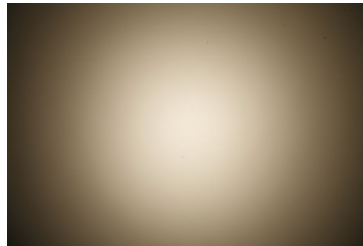

Light distribution files

inventronics

LED PrevaLED Core Z3 LES9
 FWHM / FWTM 38.0° / 96.0°
 Efficiency 93 %
 Peak intensity 1.3 cd/lm
 LEDs/each optic 1
 Light colour/type White
 Required components:
 TE Connectivity: OPTIC CLIP Z50 TYPE1 2213194-1

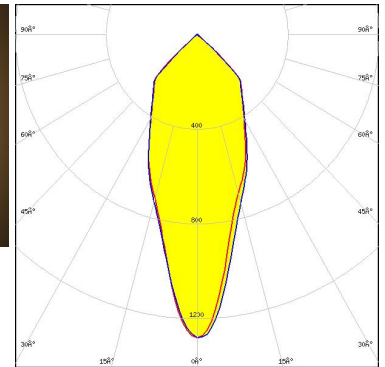
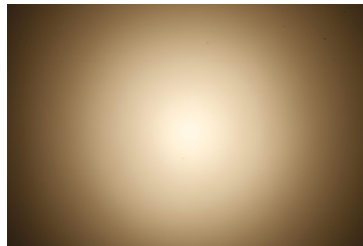

Light distribution files

inventronics

LED PrevaLED Core Z4 LES19
 FWHM / FWTM 55.0° / 100.0°
 Efficiency 88 %
 Peak intensity 0.9 cd/lm
 LEDs/each optic 1
 Light colour/type White
 Required components:
 F13671_ANGE-RZ-LENS
 TE Connectivity: OPTIC CLIP Z50 TYPE1 2213194-1

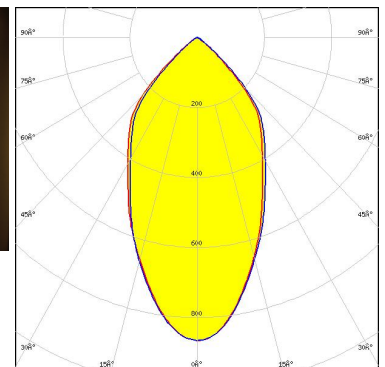
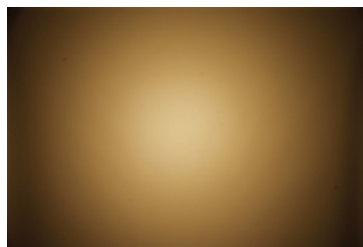

Light distribution files

OPTICAL RESULTS (MEASURED):

inventronics

LED PrevaLED Core Z4 LES19
FWHM / FWTM 47.0° / 96.0°
Efficiency 93 %
Peak intensity 1.1 cd/lm
LEDs/each optic 1
Light colour/type White
Required components:
TE Connectivity: OPTIC CLIP Z50 TYPE1 2213194-1

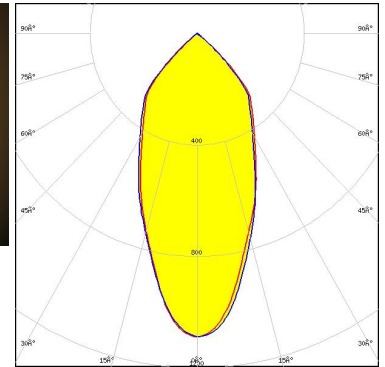
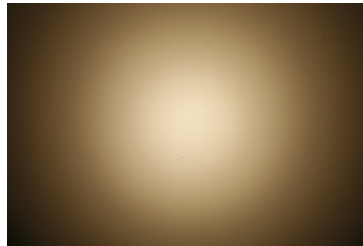

Light distribution files

LUMILEDS

LED LUXEON CoB 1202/1203
FWHM / FWTM 45.0° / 98.0°
Efficiency 93 %
Peak intensity 1.1 cd/lm
LEDs/each optic 1
Light colour/type White
Required components:
C13658_CLAMP-VERO13-18
Bender Wirth: 438 Typ L1

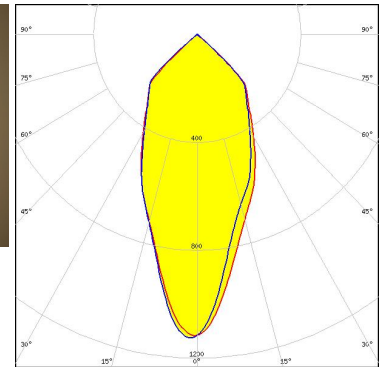
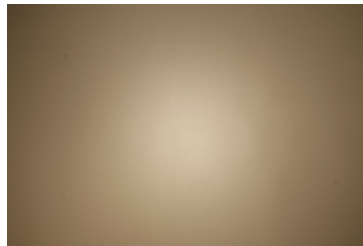

Light distribution files

LUMILEDS

LED LUXEON CoB 1204/1205
FWHM / FWTM 45.0° / 96.0°
Efficiency 94 %
Peak intensity 1.2 cd/lm
LEDs/each optic 1
Light colour/type White
Required components:
TE Connectivity: 2213130-2 + OPTIC CLIP Z50 TYPE1 2213194-1

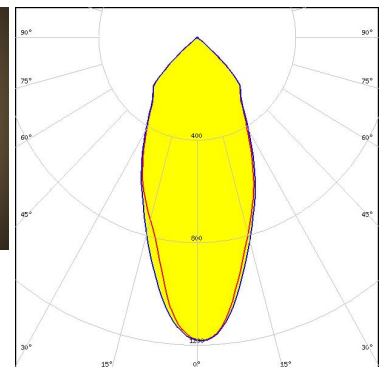
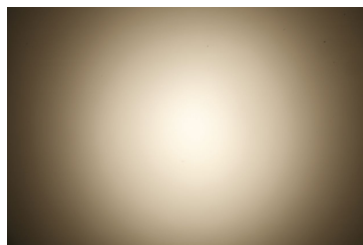

Light distribution files

OPTICAL RESULTS (MEASURED):



LED LUXEON CoB 1204/1205
FWHM / FWTM 40.0° / 94.0°
Efficiency 93 %
Peak intensity 1.2 cd/lm
LEDs/each optic 1
Light colour/type White
Required components:
 IDEAL: 50-2100SH + 50-2100AN

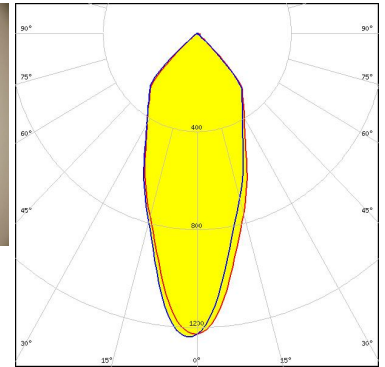
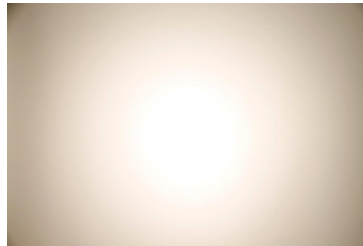

Light distribution files



LED LUXEON CoB 1204HD
FWHM / FWTM 43.0° / 97.0°
Efficiency 94 %
Peak intensity 1.2 cd/lm
LEDs/each optic 1
Light colour/type White
Required components:
 TE Connectivity: 2213382-2 + OPTIC CLIP Z50 TYPE1 2213194-1

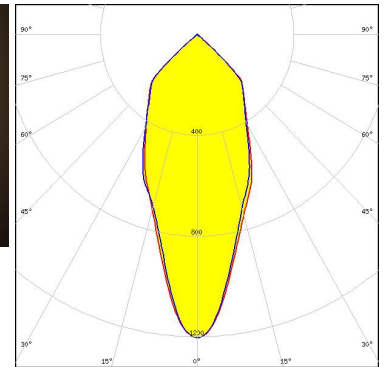
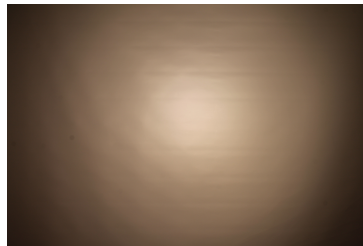

Light distribution files



LED LUXEON CoB 1205HD
FWHM / FWTM 46.0° / 97.0°
Efficiency 94 %
Peak intensity 1.1 cd/lm
LEDs/each optic 1
Light colour/type White
Required components:

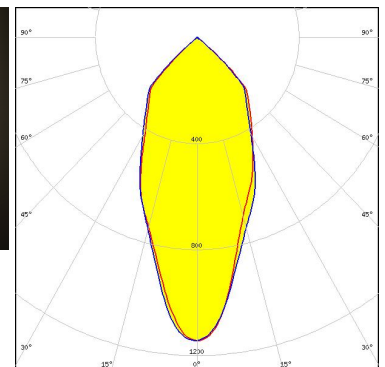
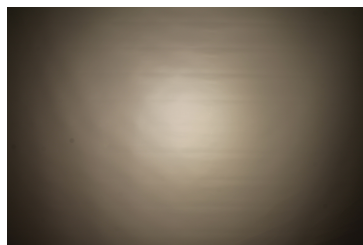

Light distribution files

OPTICAL RESULTS (MEASURED):



LED LUXEON CoB 1208
 FWHM / FWTM 44.0° / 95.0°
 Efficiency 93 %
 Peak intensity 1.2 cd/lm
 LEDs/each optic 1
 Light colour/type White
 Required components:
 IDEAL: 50-2100SH + 50-2100AN

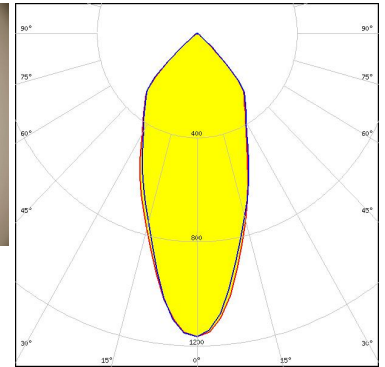
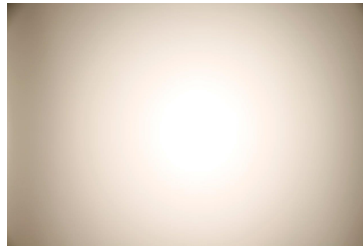

Light distribution files



LED LUXEON CoB 1208
 FWHM / FWTM 48.0° / 96.0°
 Efficiency 93 %
 Peak intensity 1.1 cd/lm
 LEDs/each optic 1
 Light colour/type White
 Required components:
 TE Connectivity: 2213130-2 + OPTIC CLIP Z50 TYPE1 2213194-1

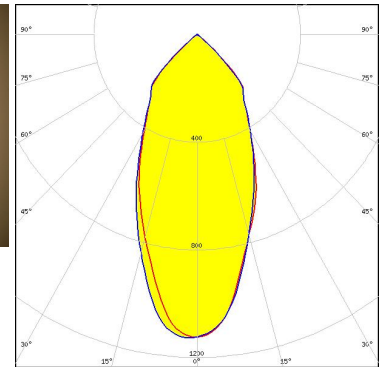
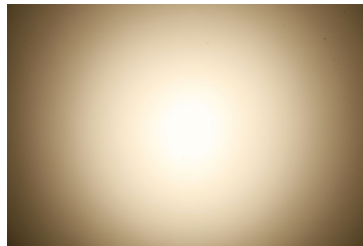

Light distribution files



LED LUXEON CoB 1211
 FWHM / FWTM 55.0° / 99.0°
 Efficiency 93 %
 Peak intensity 0.9 cd/lm
 LEDs/each optic 1
 Light colour/type White
 Required components:
 C13584_CLAMP-VERO29
 Bender Wirth: 431 Typ L3

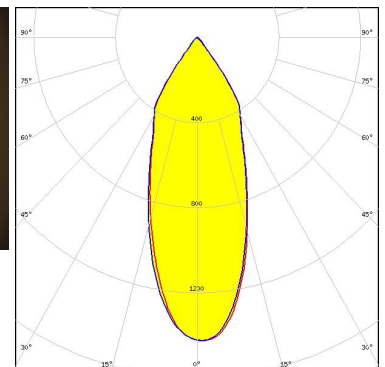
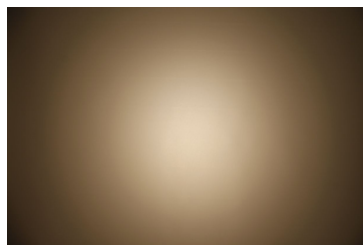

Light distribution files

OPTICAL RESULTS (MEASURED):



LED LUXEON CoB 1211
FWHM / FWTM 53.0° / 97.0°
Efficiency 91 %
Peak intensity 0.9 cd/lm
LEDs/each optic 1
Light colour/type White
Required components:
 IDEAL: 50-2204-CT + 50-2100AN

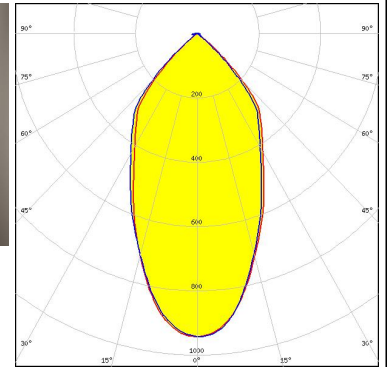

Light distribution files



LED LUXEON CoB 1213/1216/1812
FWHM / FWTM 58.0° / 99.0°
Efficiency 91 %
Peak intensity 0.9 cd/lm
LEDs/each optic 1
Light colour/type White
Required components:
 IDEAL: 50-2204-CT + 50-2100AN

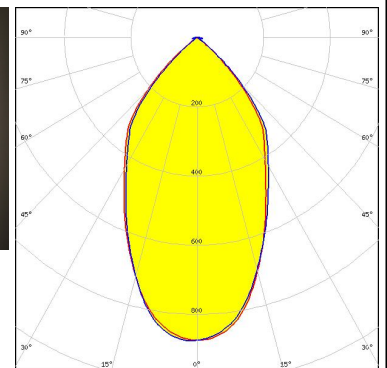

Light distribution files



LED LUXEON K12
FWHM / FWTM 54.0° / 100.0°
Efficiency 89 %
Peak intensity 1 cd/lm
LEDs/each optic 1
Light colour/type White
Required components:
 F13671_ANGE-RZ-LENS
 TE Connectivity: 2213134-2 + OPTIC CLIP Z50 TYPE1 2213194-1

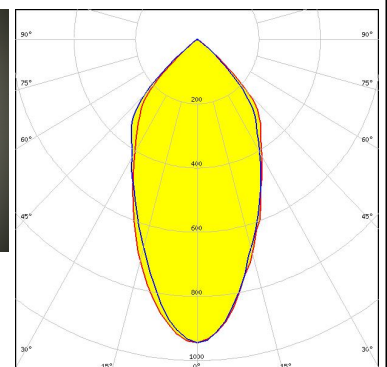
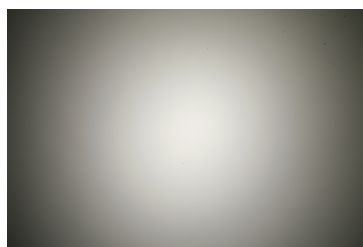

Light distribution files

OPTICAL RESULTS (MEASURED):



LED LUXEON K12
FWHM / FWTM 45.0° / 97.0°
Efficiency 94 %
Peak intensity 1.2 cd/lm
LEDs/each optic 1
Light colour/type White

Required components:

TE Connectivity: 2213134-2 + OPTIC CLIP Z50 TYPE1 2213194-1

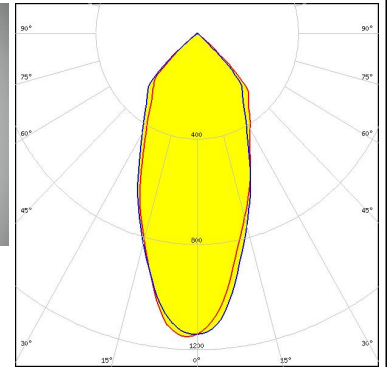
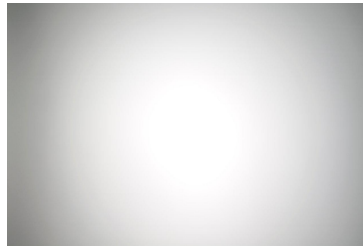

Light distribution files



LED LUXEON K16
FWHM / FWTM 54.0° / 100.0°
Efficiency 89 %
Peak intensity 0.9 cd/lm
LEDs/each optic 1
Light colour/type White

Required components:

F13671_ANGE-RZ-LENS

TE Connectivity: 2213134-2 + OPTIC CLIP Z50 TYPE1 2213194-1

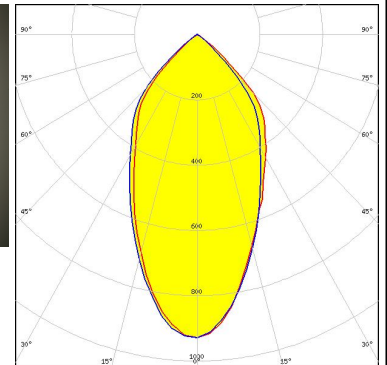
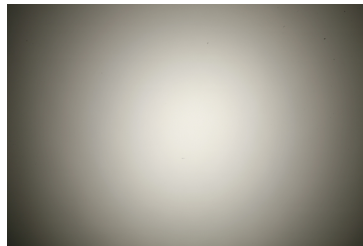

Light distribution files



LED LUXEON K16
FWHM / FWTM 48.0° / 97.0°
Efficiency 94 %
Peak intensity 1 cd/lm
LEDs/each optic 1
Light colour/type White

Required components:

TE Connectivity: 2213134-2 + OPTIC CLIP Z50 TYPE1 2213194-1

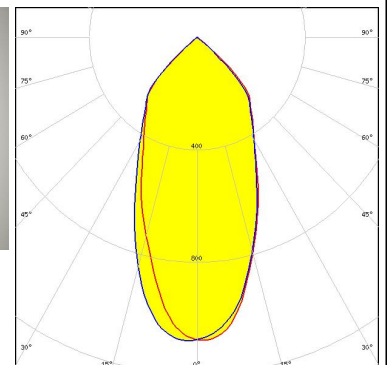
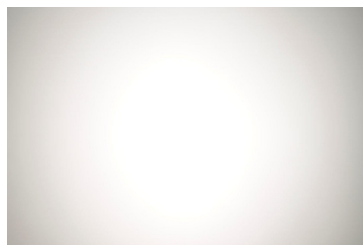

Light distribution files

OPTICAL RESULTS (MEASURED):



LED LUXEON S2000
FWHM / FWTM 42.0° / 96.0°
Efficiency 92 %
Peak intensity 1.3 cd/lm
LEDs/each optic 1
Light colour/type White
Required components:
C13395_CLAMP-S2000

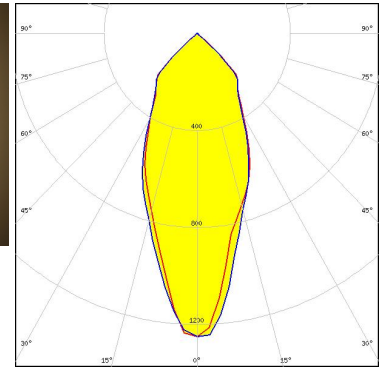
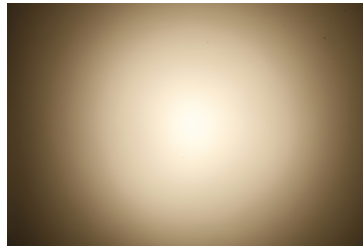

Light distribution files



LED LUXEON S3000
FWHM / FWTM 44.0° / 96.0°
Efficiency 92 %
Peak intensity 1.2 cd/lm
LEDs/each optic 1
Light colour/type White
Required components:
C13397_CLAMP-S3000

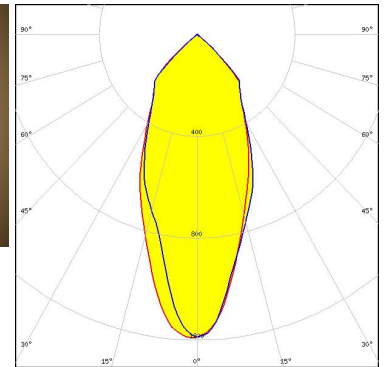
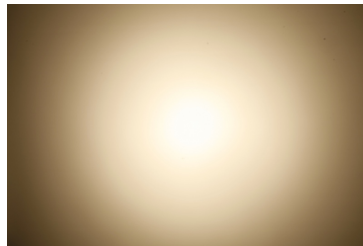

Light distribution files



LED LUXEON S5000
FWHM / FWTM 49.0° / 97.0°
Efficiency 92 %
Peak intensity 1 cd/lm
LEDs/each optic 1
Light colour/type White
Required components:
C13399_CLAMP-S5000

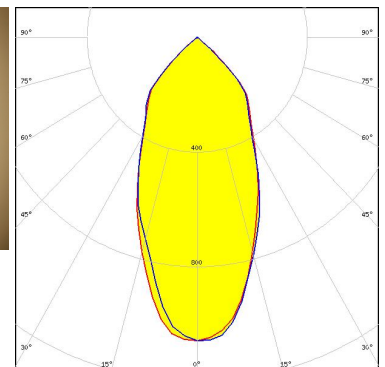

Light distribution files

OPTICAL RESULTS (MEASURED):



LED CDM-14 (Dim-To-Warm)
FWHM / FWTM 55.0° / 101.0°
Efficiency 89 %
Peak intensity 0.9 cd/lm
LEDs/each optic 1
Light colour/type White
Required components:
 C13658_CLAMP-VERO13-18
 F13671_ANGE-RZ-LENS
 Bender Wirth: 491 Typ L2

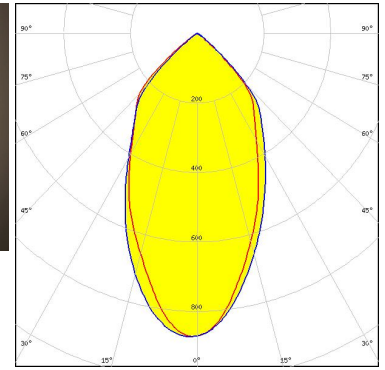
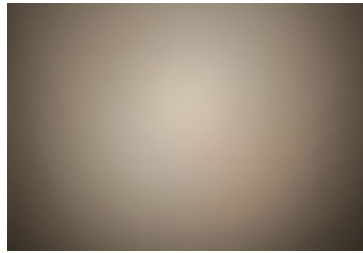

Light distribution files



LED CDM-14 (Dim-To-Warm)
FWHM / FWTM 53.0° / 99.0°
Efficiency 93 %
Peak intensity 1 cd/lm
LEDs/each optic 1
Light colour/type White
Required components:
 C13658_CLAMP-VERO13-18
 Bender Wirth: 491 Typ L2

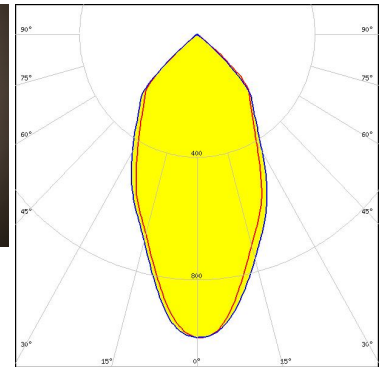
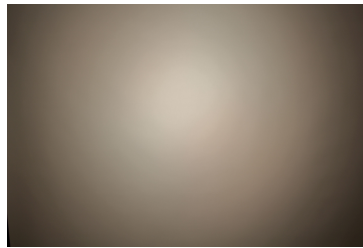

Light distribution files



LED CDM-18 (Dim-To-Warm)
FWHM / FWTM 58.0° / 101.0°
Efficiency 90 %
Peak intensity 0.8 cd/lm
LEDs/each optic 1
Light colour/type White
Required components:
 C13658_CLAMP-VERO13-18
 F13671_ANGE-RZ-LENS
 Bender Wirth: 491 Typ L2

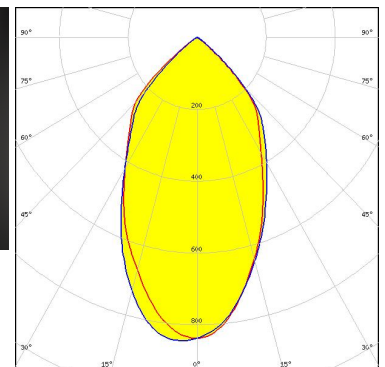
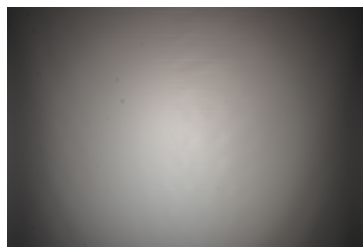

Light distribution files

OPTICAL RESULTS (MEASURED):



LED CDM-18 (Dim-To-Warm)
FWHM / FWTM 56.0° / 100.0°
Efficiency 94 %
Peak intensity 0.9 cd/lm
LEDs/each optic 1
Light colour/type White
Required components:
 C13658_CLAMP-VERO13-18
 Bender Wirth: 491 Typ L2

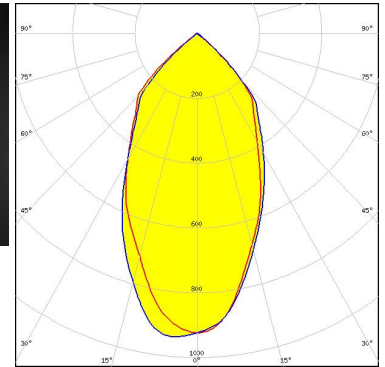
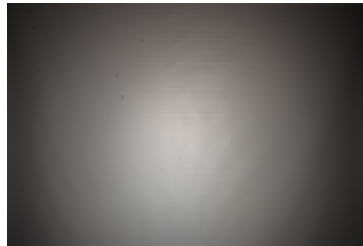

Light distribution files



LED CDM-9 (Dim-To-Warm)
FWHM / FWTM 46.0° / 98.0°
Efficiency 91 %
Peak intensity 1.1 cd/lm
LEDs/each optic 1
Light colour/type White
Required components:
 C13658_CLAMP-VERO13-18
 Bender Wirth: 490 Typ L1

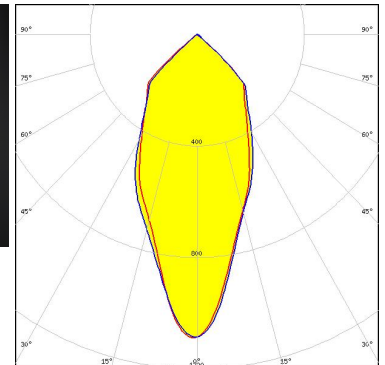
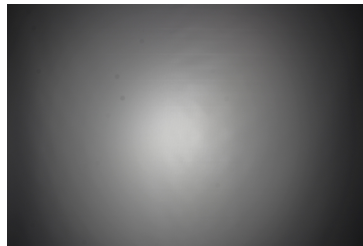

Light distribution files



LED CDM-9 (Dim-To-Warm)
FWHM / FWTM 51.0° / 100.0°
Efficiency 87 %
Peak intensity 0.9 cd/lm
LEDs/each optic 1
Light colour/type White
Required components:
 C13658_CLAMP-VERO13-18
 F13671_ANGE-RZ-LENS
 Bender Wirth: 490 Typ L1

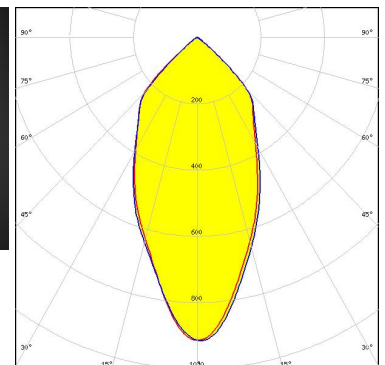
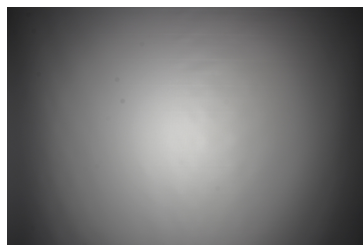

Light distribution files

OPTICAL RESULTS (MEASURED):



LED CTM-14 (Tunable White)
FWHM / FWTM 51.0° / 98.0°
Efficiency 91 %
Peak intensity 1 cd/lm
LEDs/each optic 1
Light colour/type White
Required components:
 C13584_CLAMP-VERO29
 Bender Wirth: 442 Typ L3

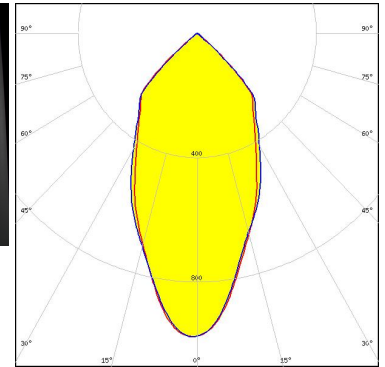
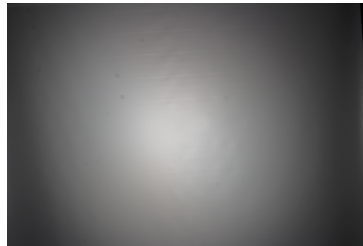

Light distribution files



LED CTM-14 (Tunable White)
FWHM / FWTM 54.0° / 100.0°
Efficiency 87 %
Peak intensity 0.9 cd/lm
LEDs/each optic 1
Light colour/type White
Required components:
 C13584_CLAMP-VERO29
 F13671_ANGE-RZ-LENS
 Bender Wirth: 442 Typ L3

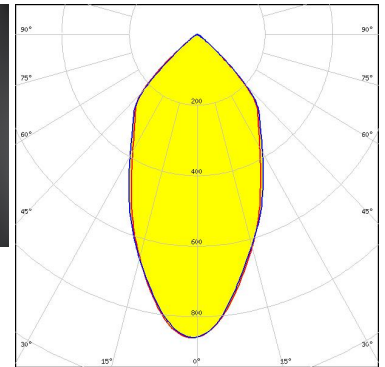
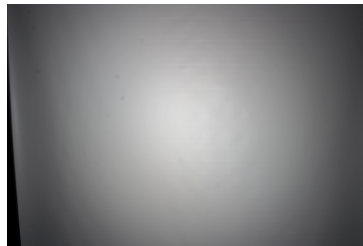

Light distribution files



LED CTM-14 RGBW
FWHM / FWTM 52.0° / 99.0°
Efficiency 90 %
Peak intensity 0.9 cd/lm
LEDs/each optic 1
Light colour/type RGBW
Required components:
 C13584_CLAMP-VERO29
 F13671_ANGE-RZ-LENS
 Bender Wirth: 500 Typ L3-1

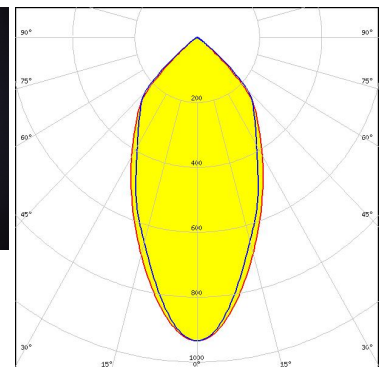
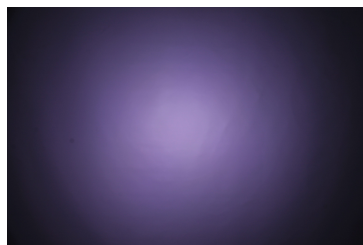

Light distribution files

OPTICAL RESULTS (MEASURED):



LED CTM-14 RGBW
FWHM / FWTM 48.0° / 98.0°
Efficiency 94 %
Peak intensity 1.1 cd/lm
LEDs/each optic 1
Light colour/type RGBW
Required components:
 C13584_CLAMP-VERO29
 Bender Wirth: 500 Typ L3-1

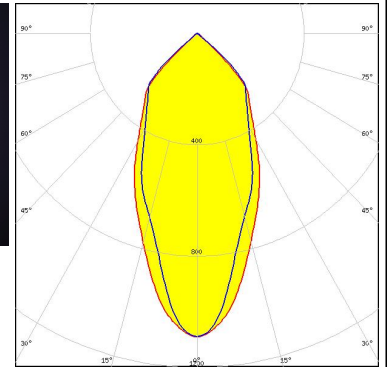

Light distribution files



LED CTM-22 (Tunable White)
FWHM / FWTM 60.0° / 101.0°
Efficiency 90 %
Peak intensity 0.8 cd/lm
LEDs/each optic 1
Light colour/type White
Required components:
 C13584_CLAMP-VERO29
 Bender Wirth: 494 Typ L3

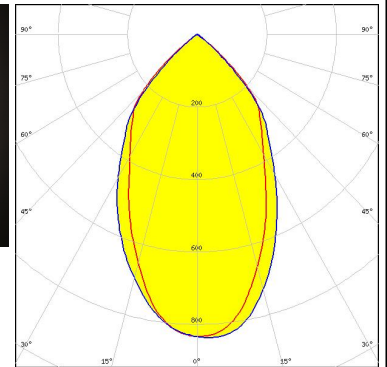
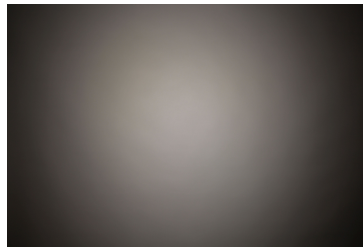

Light distribution files



LED CTM-22 (Tunable White)
FWHM / FWTM 61.0° / 102.0°
Efficiency 86 %
Peak intensity 0.8 cd/lm
LEDs/each optic 1
Light colour/type White
Required components:
 C13584_CLAMP-VERO29
 F13671_ANGE-RZ-LENS
 Bender Wirth: 494 Typ L3

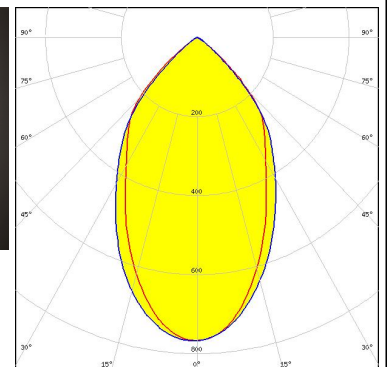
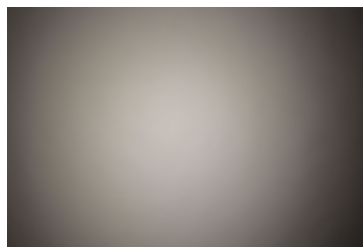

Light distribution files

OPTICAL RESULTS (MEASURED):



LED CxM-14 (19x19)
 FWHM / FWTM 48.0° / 98.0°
 Efficiency 93 %
 Peak intensity 1.1 cd/lm
 LEDs/each optic 1
 Light colour/type White

Required components:

TE Connectivity: 2213254-2 + OPTIC CLIP Z50 TYPE1 2213194-1

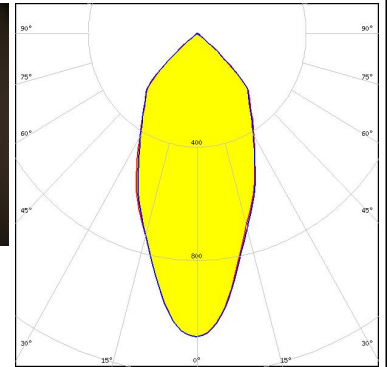
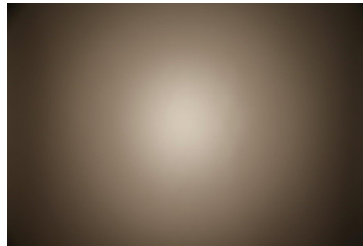

Light distribution files



LED COB J-Type
 FWHM / FWTM 51.0° / 99.0°
 Efficiency 93 %
 Peak intensity 1 cd/lm
 LEDs/each optic 1
 Light colour/type White

Required components:

C13658_CLAMP-VERO13-18

Bender Wirth: 463 Typ L2

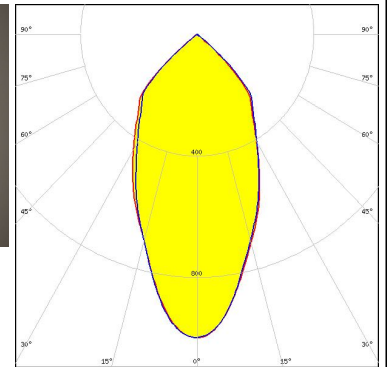
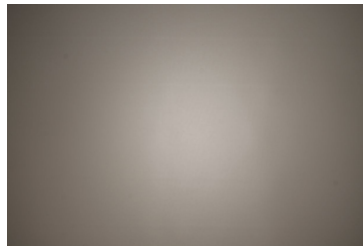

Light distribution files



LED COB J-Type
 FWHM / FWTM 43.0° / 95.0°
 Efficiency 94 %
 Peak intensity 1.2 cd/lm
 LEDs/each optic 1
 Light colour/type White

Required components:

IDEAL: 50-2103NC + 50-2100AN

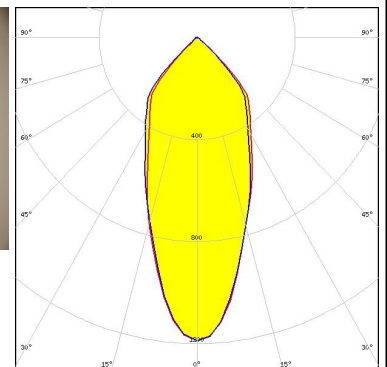
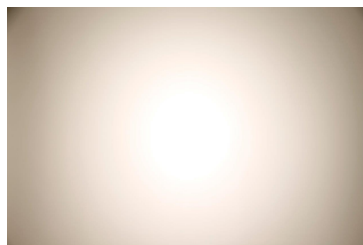

Light distribution files

OPTICAL RESULTS (MEASURED):



LED COB J-Type
FWHM / FWTM 48.0° / 98.0°
Efficiency 87 %
Peak intensity 0.9 cd/lm
LEDs/each optic 1
Light colour/type White
Required components:
 F13671_ANGE-RZ-LENS
 IDEAL: 50-2103NC + 50-2100AN

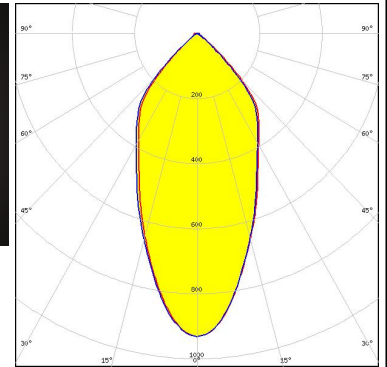

Light distribution files



LED COB L-Type (LES 11)
FWHM / FWTM 39.0° / 94.0°
Efficiency 91 %
Peak intensity 1.2 cd/lm
LEDs/each optic 1
Light colour/type White
Required components:
 IDEAL: 50-2100NC + 50-2100AN

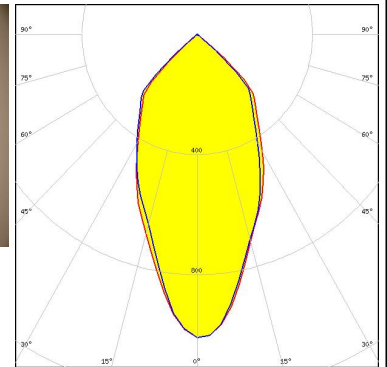
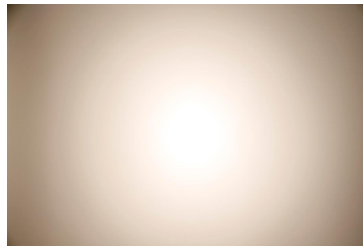

Light distribution files



LED COB L-Type (LES 11)
FWHM / FWTM 48.0° / 97.0°
Efficiency 92 %
Peak intensity 1.1 cd/lm
LEDs/each optic 1
Light colour/type White
Required components:
 TE Connectivity: 2213382-2 + OPTIC CLIP Z50 TYPE1 2213194-1

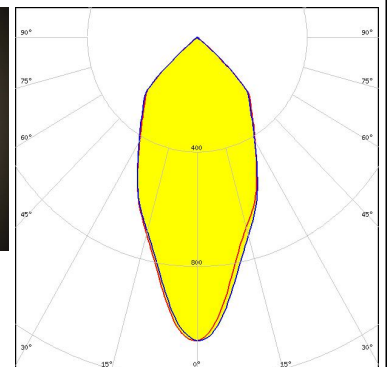
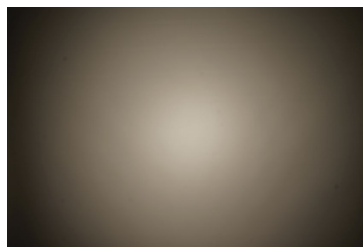

Light distribution files

OPTICAL RESULTS (MEASURED):



LED COB L-Type (LES 11)
 FWHM / FWTM 48.0° / 97.0°
 Efficiency 92 %
 Peak intensity 1.1 cd/lm
 LEDs/each optic 1
 Light colour/type White

Required components:

TE Connectivity: 2213382-2 + OPTIC CLIP Z50 TYPE1 2213194-1

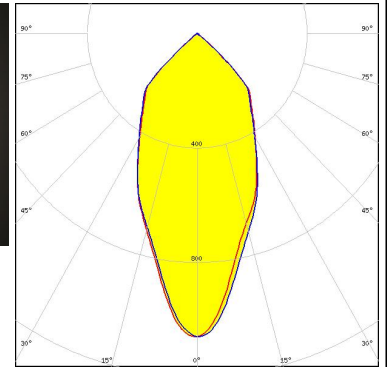

Light distribution files



LED COB L-Type (LES 11)
 FWHM / FWTM 47.0° / 98.0°
 Efficiency 92 %
 Peak intensity 1.1 cd/lm
 LEDs/each optic 1
 Light colour/type White

Required components:

C13658_CLAMP-VERO13-18

Bender Wirth: 438 Typ L1

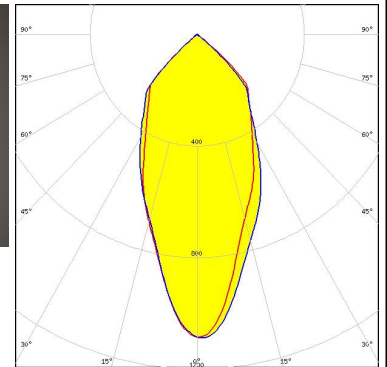
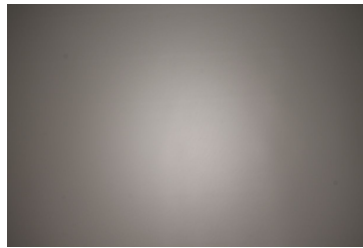

Light distribution files



LED COB L-Type (LES 11)
 FWHM / FWTM 51.0° / 99.0°
 Efficiency 94 %
 Peak intensity 1 cd/lm
 LEDs/each optic 1
 Light colour/type White

Required components:

Molex: 180580-0005

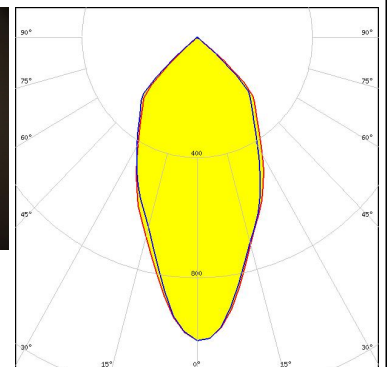
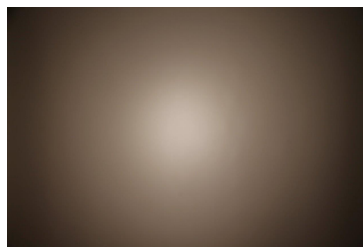

Light distribution files

OPTICAL RESULTS (MEASURED):



LED NVCWJ024Z-V1MT: COB J-Type Tunable White
 FWHM / FWTM 57.0° / 102.0°
 Efficiency 87 %
 Peak intensity 0.9 cd/lm
 LEDs/each optic 1
 Light colour/type White
 Required components:
 C13658_CLAMP-VERO13-18
 F13671_ANGE-RZ-LENS
 Bender Wirth: 498 Typ L2

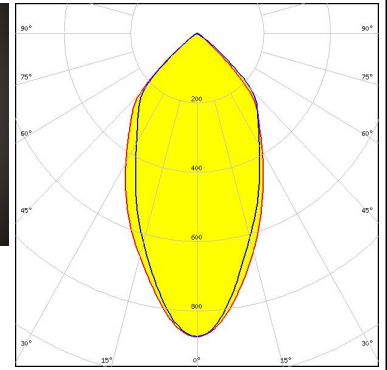

Light distribution files



LED NVCWJ024Z-V1MT: COB J-Type Tunable White
 FWHM / FWTM 53.0° / 100.0°
 Efficiency 92 %
 Peak intensity 1 cd/lm
 LEDs/each optic 1
 Light colour/type White
 Required components:
 C13658_CLAMP-VERO13-18
 Bender Wirth: 498 Typ L2

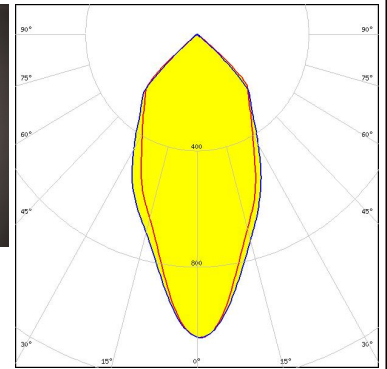
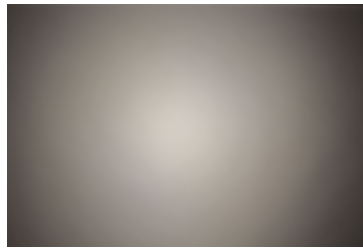

Light distribution files



LED Soleriq S13
 FWHM / FWTM 49.0° / 97.0°
 Efficiency 92 %
 Peak intensity 1.1 cd/lm
 LEDs/each optic 1
 Light colour/type White
 Required components:
 C13658_CLAMP-VERO13-18
 Bender Wirth: 437 Typ L1

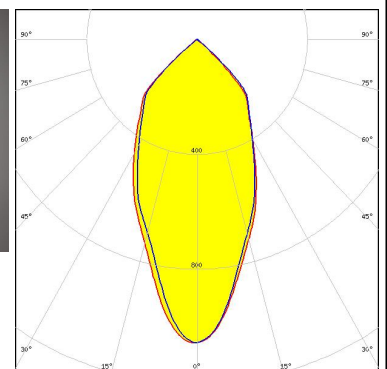
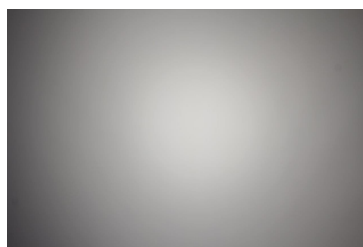

Light distribution files

OPTICAL RESULTS (MEASURED):

OSRAM
Opto Semiconductors

LED Soleriq S13
FWHM / FWTM 47.0° / 98.0°
Efficiency 94 %
Peak intensity 1.2 cd/lm
LEDs/each optic 1
Light colour/type White

Required components:

TE Connectivity: 2213401-2 + OPTIC CLIP Z50 TYPE1 2213194-1

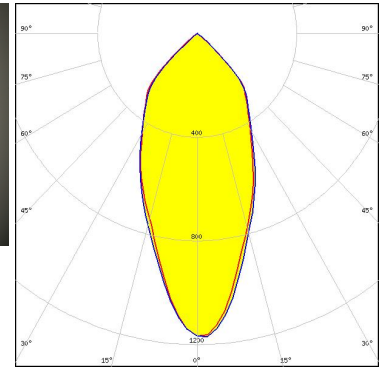
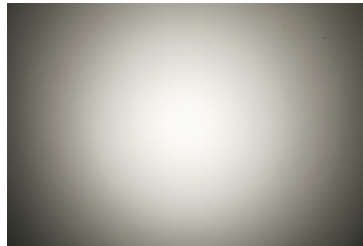

Light distribution files

OSRAM
Opto Semiconductors

LED Soleriq S13 19x19
FWHM / FWTM 45.0° / 96.0°
Efficiency 91 %
Peak intensity 1.1 cd/lm
LEDs/each optic 1
Light colour/type White

Required components:

IDEAL: 50-2103CT + 50-2100AN

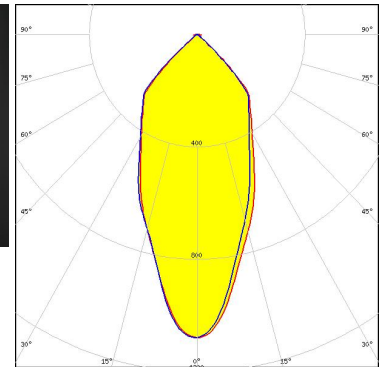
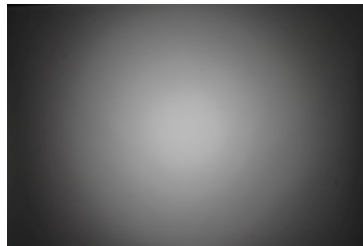

Light distribution files

OSRAM
Opto Semiconductors

LED Soleriq S13 19x19
FWHM / FWTM 51.0° / 98.0°
Efficiency 92 %
Peak intensity 1 cd/lm
LEDs/each optic 1
Light colour/type White

Required components:

TE Connectivity: 2213254-2 + OPTIC CLIP Z50 TYPE1 2213194-1

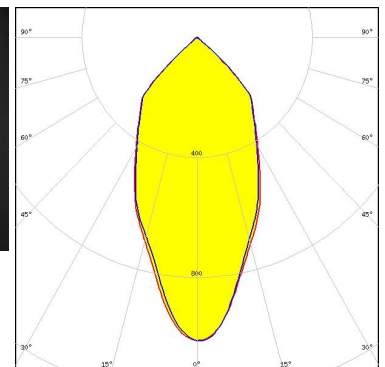
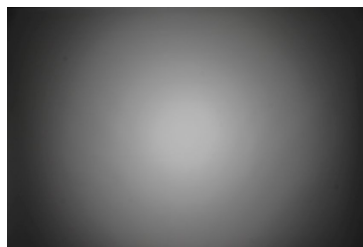

Light distribution files

OPTICAL RESULTS (MEASURED):

OSRAM
Opto Semiconductors

LED Soleriq S19
FWHM / FWTM 49.0° / 97.0°
Efficiency 94 %
Peak intensity 1.1 cd/lm
LEDs/each optic 1
Light colour/type White

Required components:

TE Connectivity: 2213407-2 + OPTIC CLIP Z50 TYPE1 2213194-1

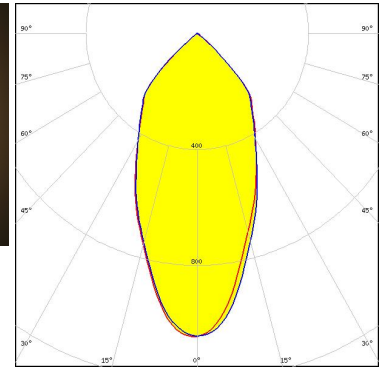
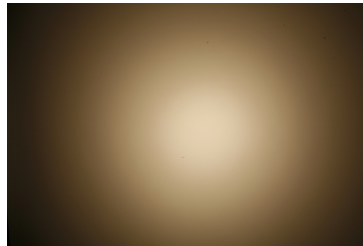

Light distribution files

OSRAM
Opto Semiconductors

LED Soleriq S19
FWHM / FWTM 48.0° / 96.0°
Efficiency 91 %
Peak intensity 1 cd/lm
LEDs/each optic 1
Light colour/type White

Required components:

C13584_CLAMP-VERO29

Bender Wirth: 462 Typ L3

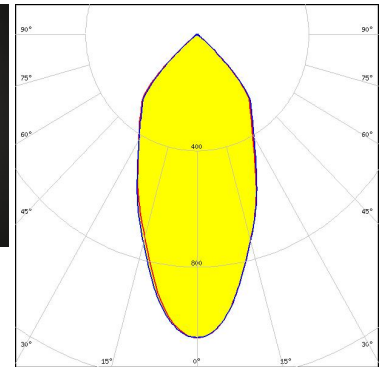
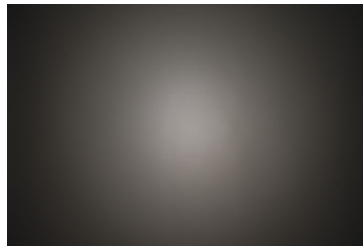

Light distribution files

PHILIPS

LED Fortimo SLM L09 + SLM holder
FWHM / FWTM 42.0° / 96.0°
Efficiency 92 %
Peak intensity 1.2 cd/lm
LEDs/each optic 1
Light colour/type White

Required components:

TE Connectivity: OPTIC CLIP Z50 TYPE1 2213194-1

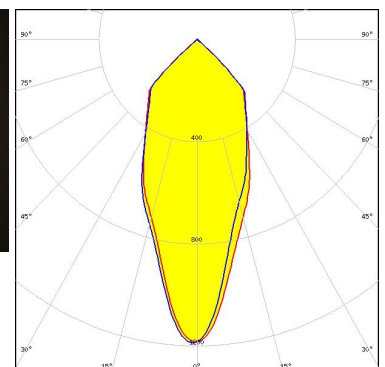
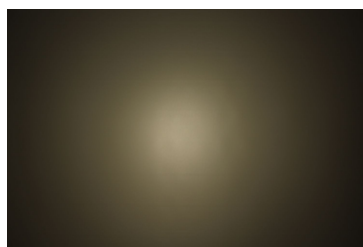

Light distribution files

OPTICAL RESULTS (MEASURED):

PHILIPS

LED Fortimo SLM L13 + SLM holder
 FWHM / FWTM 48.0° / 96.0°
 Efficiency 92 %
 Peak intensity 1.1 cd/lm
 LEDs/each optic 1
 Light colour/type White
 Required components:
 TE Connectivity: OPTIC CLIP Z50 TYPE1 2213194-1

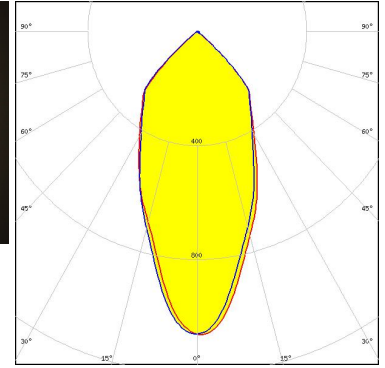
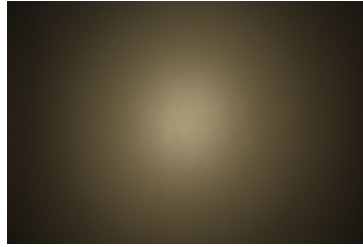

Light distribution files

PHILIPS

LED Fortimo SLM L13 CoB
 FWHM / FWTM 49.0° / 98.0°
 Efficiency 94 %
 Peak intensity 1.1 cd/lm
 LEDs/each optic 1
 Light colour/type White
 Required components:
 TE Connectivity: 2213130-2 + OPTIC CLIP Z50 TYPE1 2213194-1

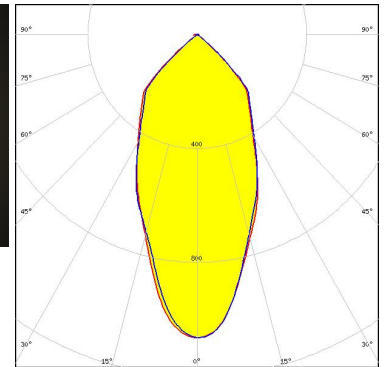
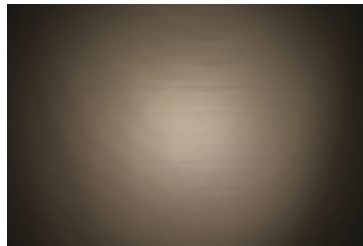

Light distribution files

PHILIPS

LED Fortimo SLM L13 CoB
 FWHM / FWTM 54.0° / 100.0°
 Efficiency 88 %
 Peak intensity 0.9 cd/lm
 LEDs/each optic 1
 Light colour/type White
 Required components:
 F13671_ANGE-RZ-LENS
 TE Connectivity: 2213130-2 + OPTIC CLIP Z50 TYPE1 2213194-1

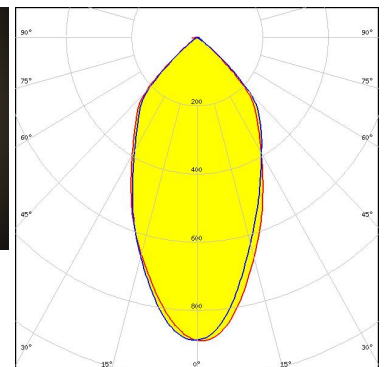
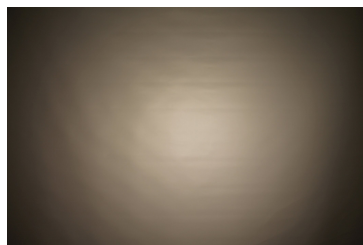

Light distribution files

OPTICAL RESULTS (MEASURED):

PHILIPS

LED Fortimo SLM L15 + SLM holder
FWHM / FWTM 57.0° / 100.0°
Efficiency 87 %
Peak intensity 0.8 cd/lm
LEDs/each optic 1
Light colour/type White
Required components:
F13671_ANGE-RZ-LENS
TE Connectivity: OPTIC CLIP Z50 TYPE1 2213194-1

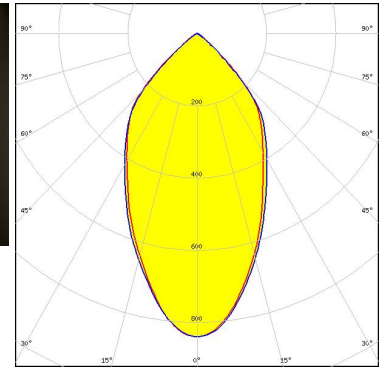
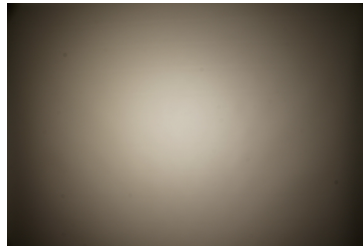

Light distribution files

PHILIPS

LED Fortimo SLM L15 + SLM holder
FWHM / FWTM 51.0° / 97.0°
Efficiency 90 %
Peak intensity 1 cd/lm
LEDs/each optic 1
Light colour/type White
Required components:
TE Connectivity: OPTIC CLIP Z50 TYPE1 2213194-1

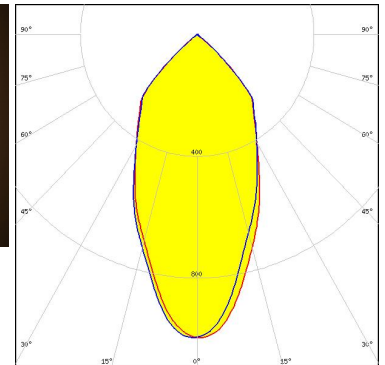
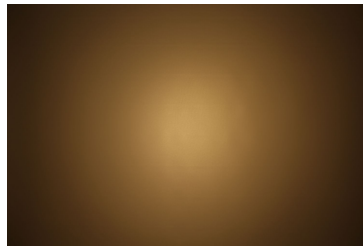

Light distribution files

PHILIPS

LED Fortimo SLM L15 CoB
FWHM / FWTM 53.0° / 100.0°
Efficiency 89 %
Peak intensity 0.9 cd/lm
LEDs/each optic 1
Light colour/type White
Required components:
F13671_ANGE-RZ-LENS
TE Connectivity: 2213130-2 + OPTIC CLIP Z50 TYPE1 2213194-1

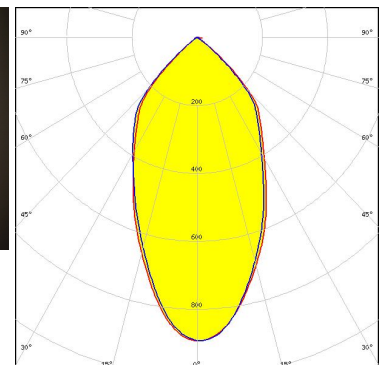
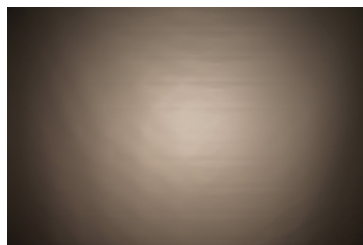

Light distribution files

OPTICAL RESULTS (MEASURED):

PHILIPS

LED Fortimo SLM L15 CoB
 FWHM / FWTM 50.0° / 98.0°
 Efficiency 94 %
 Peak intensity 1 cd/lm
 LEDs/each optic 1
 Light colour/type White

Required components:

TE Connectivity: 2213130-2 + OPTIC CLIP Z50 TYPE1 2213194-1

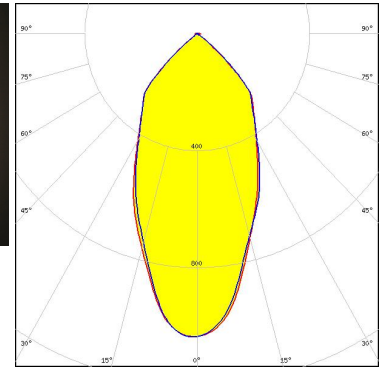
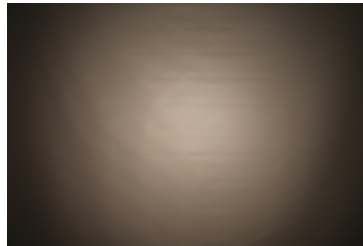

Light distribution files

PHILIPS

LED Fortimo SLM L19 + SLM holder
 FWHM / FWTM 54.0° / 98.0°
 Efficiency 89 %
 Peak intensity 0.9 cd/lm
 LEDs/each optic 1
 Light colour/type White

Required components:

TE Connectivity: OPTIC CLIP Z50 TYPE1 2213194-1

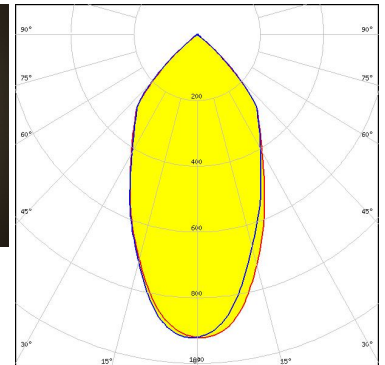
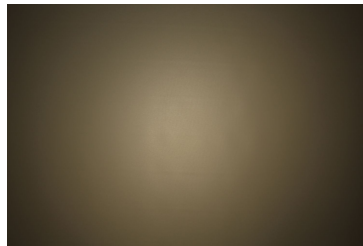

Light distribution files

SAMSUNG

LED LC026B / 033B / 040B
 FWHM / FWTM 54.0° / 99.0°
 Efficiency 92 %
 Peak intensity 1 cd/lm
 LEDs/each optic 1
 Light colour/type White

Required components:

C13658_CLAMP-VERO13-18

Bender Wirth: 450 Typ L2

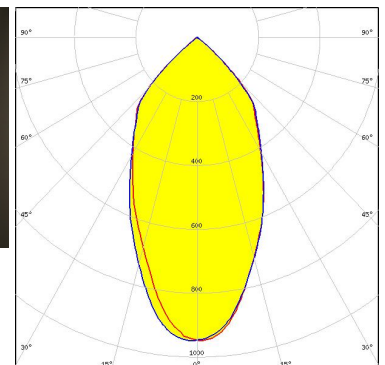
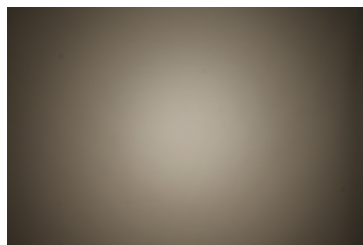

Light distribution files

OPTICAL RESULTS (MEASURED):

SAMSUNG

LED LC026B / 033B / 040B
FWHM / FWTM 51.0° / 98.0°
Efficiency 92 %
Peak intensity 1 cd/lm
LEDs/each optic 1
Light colour/type White

Required components:

TE Connectivity: 2213258-2 + OPTIC CLIP Z50 TYPE1 2213194-1

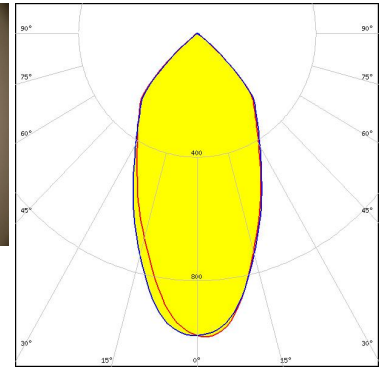
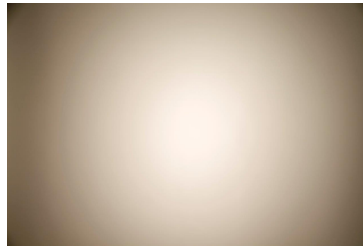

Light distribution files

SAMSUNG

LED LC035T (Tunable white)
FWHM / FWTM 69.0° / 105.0°
Efficiency 88 %
Peak intensity 0.7 cd/lm
LEDs/each optic 1
Light colour/type Tunable White

Required components:

C13584_CLAMP-VERO29
F13671_ANGE-RZ-LENS
Bender Wirth: 502 Typ L3

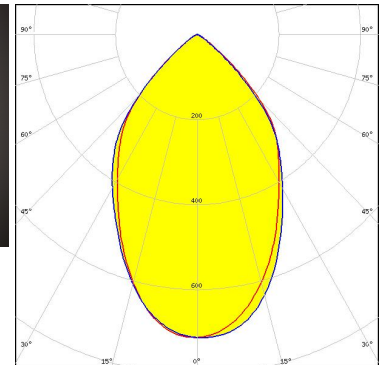
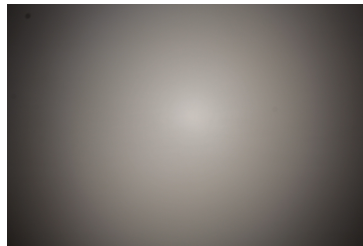

Light distribution files

SAMSUNG

LED LC035T (Tunable white)
FWHM / FWTM 66.0° / 102.0°
Efficiency 93 %
Peak intensity 0.8 cd/lm
LEDs/each optic 1
Light colour/type Tunable White

Required components:

C13584_CLAMP-VERO29
Bender Wirth: 502 Typ L3

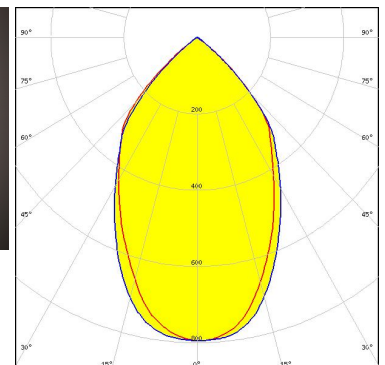
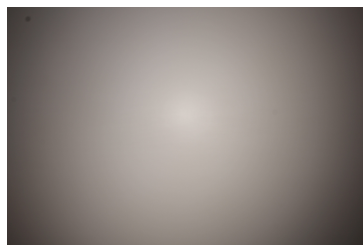

Light distribution files

OPTICAL RESULTS (MEASURED):

SAMSUNG

LED LC040C
 FWHM / FWTM 46.0° / 96.0°
 Efficiency 90 %
 Peak intensity 1.1 cd/lm
 LEDs/each optic 1
 Light colour/type White

Required components:

TE Connectivity: 2213382-2 + OPTIC CLIP Z50 TYPE1 2213194-1

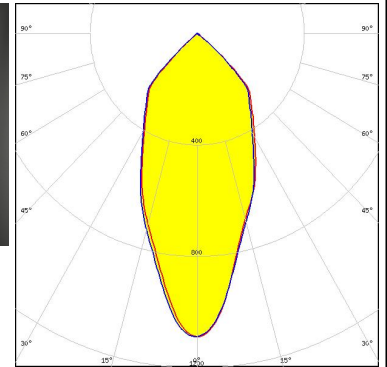
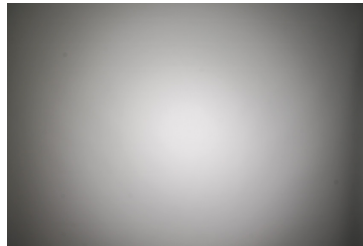

Light distribution files



SEOUL SEMICONDUCTOR

LED AC Zhaga COB
 FWHM / FWTM 64.0° / 103.0°
 Efficiency 89 %
 Peak intensity 0.8 cd/lm
 LEDs/each optic 1
 Light colour/type White

Required components:

F13671_ANGE-RZ-LENS
 Optosource: SEHSMJD-A

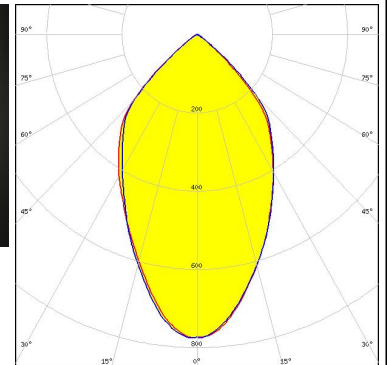
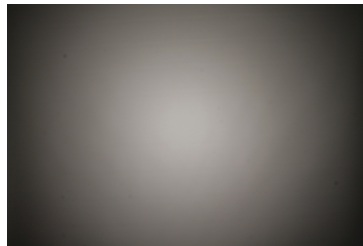

Light distribution files



SEOUL SEMICONDUCTOR

LED MJT COB LES 14.5
 FWHM / FWTM 54.0° / 98.0°
 Efficiency 92 %
 Peak intensity 1 cd/lm
 LEDs/each optic 1
 Light colour/type White

Required components:

TE Connectivity: 2213254-2 + OPTIC CLIP Z50 TYPE1 2213194-1

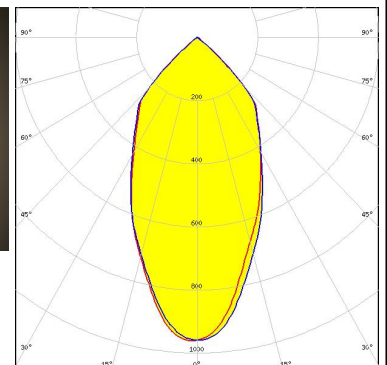
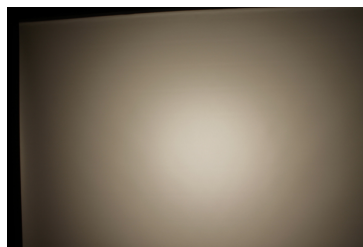

Light distribution files

OPTICAL RESULTS (MEASURED):



SEUL SEMICONDUCTOR

LED MJT COB LES 22

FWHM / FWTM 58.0° / 99.0°

Efficiency 90 %

Peak intensity 0.9 cd/lm

LEDs/each optic 1

Light colour/type White

Required components:
C13584_CLAMP-VERO29
Bender Wirth: 431 Typ L3

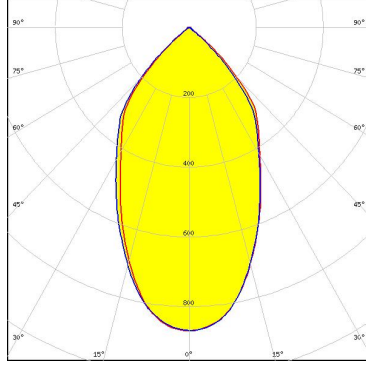

Light distribution files



LED Mega Zenigata (GW6DME)

FWHM / FWTM 47.0° / 96.0°

Efficiency 92 %

Peak intensity 1.1 cd/lm

LEDs/each optic 1

Light colour/type White

Required components:
TE Connectivity: 2213130-2 + OPTIC CLIP Z50 TYPE1 2213194-1



Light distribution files



LED Mega Zenigata (GW6DME)

FWHM / FWTM 43.0° / 95.0°

Efficiency 93 %

Peak intensity 1.2 cd/lm

LEDs/each optic 1

Light colour/type White

Required components:
IDEAL: 50-2100SH + 50-2100AN

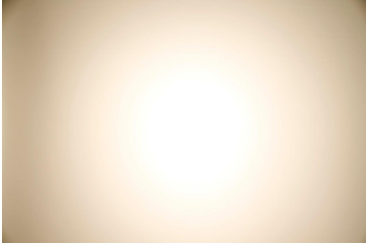
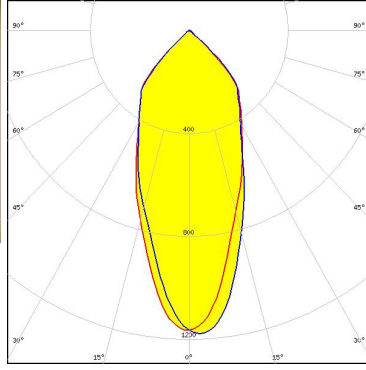



Light distribution files

OPTICAL RESULTS (MEASURED):

SHARP

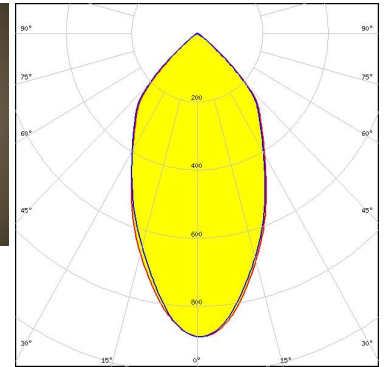
LED Mega Zenigata (GW6DME)
 FWHM / FWTM 55.0° / 99.0°
 Efficiency 89 %
 Peak intensity 0.9 cd/lm
 LEDs/each optic 1
 Light colour/type White
 Required components:
 F13671_ANGE-RZ-LENS
 TE Connectivity: 2213130-2 + OPTIC CLIP Z50 TYPE1 2213194-1



Light distribution files

VS LIGHTING SOLUTIONS

LED WU-M-461
 FWHM / FWTM 50.0° / 98.0°
 Efficiency 93 %
 Peak intensity 1.1 cd/lm
 LEDs/each optic 1
 Light colour/type White
 Required components:
 TE Connectivity: OPTIC CLIP Z50 TYPE1 2213194-1

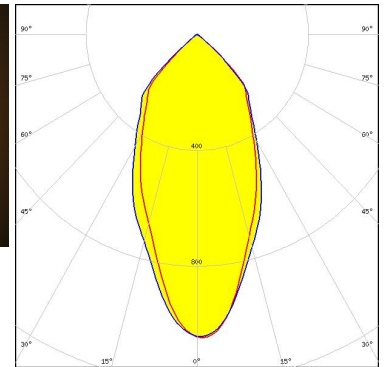
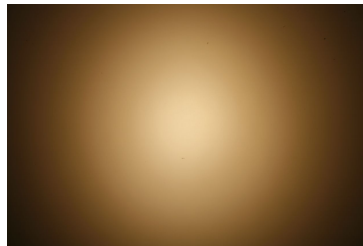

Light distribution files

VS LIGHTING SOLUTIONS

LED WU-M-462
 FWHM / FWTM 55.0° / 99.0°
 Efficiency 93 %
 Peak intensity 0.9 cd/lm
 LEDs/each optic 1
 Light colour/type White
 Required components:
 TE Connectivity: OPTIC CLIP Z50 TYPE1 2213194-1

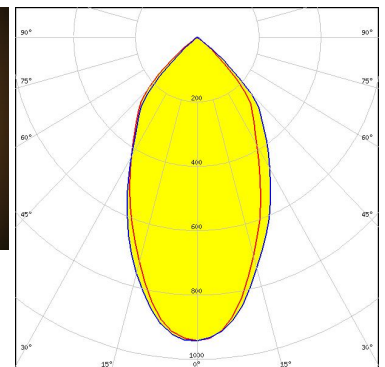
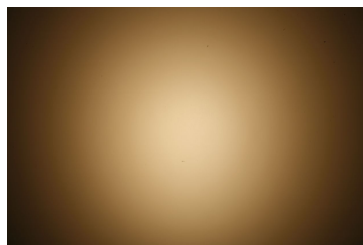

Light distribution files

OPTICAL RESULTS (MEASURED):



LED WU-M-464
 FWHM / FWTM 55.0° / 99.0°
 Efficiency 93 %
 Peak intensity 0.9 cd/lm
 LEDs/each optic 1
 Light colour/type White

Required components:

TE Connectivity: OPTIC CLIP Z50 TYPE1 2213194-1

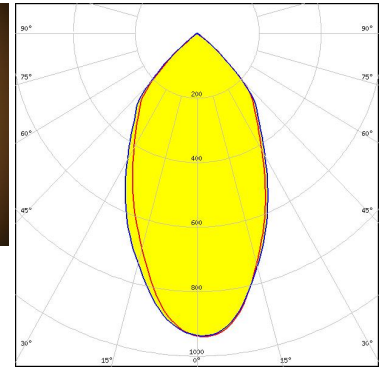
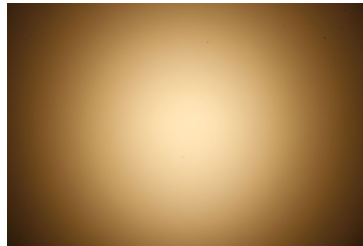

Light distribution files



LED WU-M-484
 FWHM / FWTM 51.0° / 98.0°
 Efficiency 93 %
 Peak intensity 1 cd/lm
 LEDs/each optic 1
 Light colour/type White

Required components:

TE Connectivity: OPTIC CLIP Z50 TYPE1 2213194-1

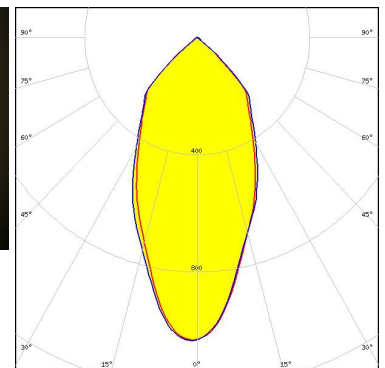
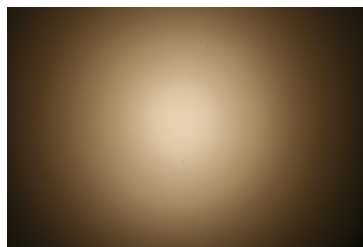

Light distribution files



LED WU-M-485
 FWHM / FWTM 57.0° / 100.0°
 Efficiency 93 %
 Peak intensity 0.9 cd/lm
 LEDs/each optic 1
 Light colour/type White

Required components:

TE Connectivity: OPTIC CLIP Z50 TYPE1 2213194-1

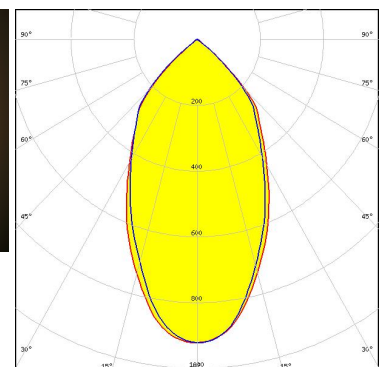
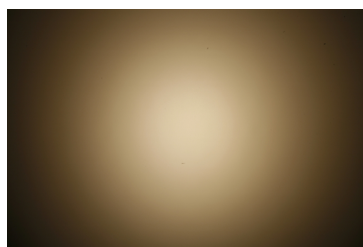

Light distribution files

OPTICAL RESULTS (MEASURED):



LED WU-M-486
FWHM / FWTM 56.0° / 100.0°
Efficiency 93 %
Peak intensity 0.9 cd/lm
LEDs/each optic 1
Light colour/type White
Required components:
TE Connectivity: OPTIC CLIP Z50 TYPE1 2213194-1

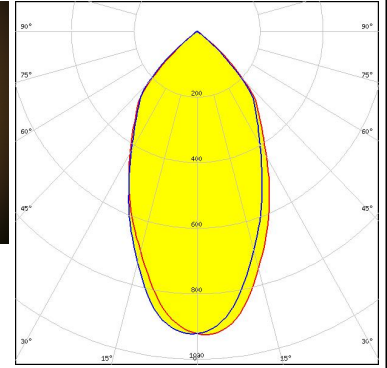

Light distribution files

OPTICAL RESULTS (SIMULATED):



LED V10 Gen7
 FWHM / FWTM 50.0° / 97.0°
 Efficiency 93 %
 Peak intensity 1.2 cd/lm
 LEDs/each optic 1
 Light colour/type White

Required components:

C13658_CLAMP-VERO13-18

Bender Wirth: 486 Typ L1

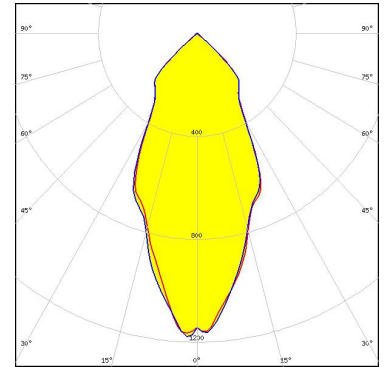

Light distribution files



LED V13 Gen7
 FWHM / FWTM 38.0° / 90.0°
 Efficiency 93 %
 Peak intensity 1.5 cd/lm
 LEDs/each optic 1
 Light colour/type White

Required components:

IDEAL: 50-2103CT + 50-2100AN

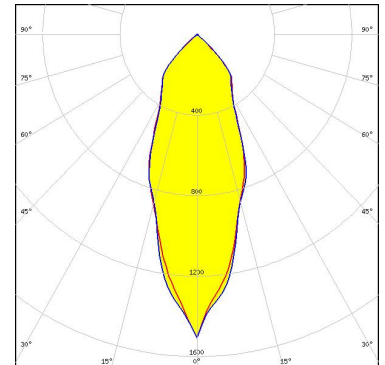

Light distribution files



LED V22 Gen7
 FWHM / FWTM 43.0° / 92.0°
 Efficiency 94 %
 Peak intensity 1.3 cd/lm
 LEDs/each optic 1
 Light colour/type White

Required components:

IDEAL: 50-2204-CT + 50-2100AN

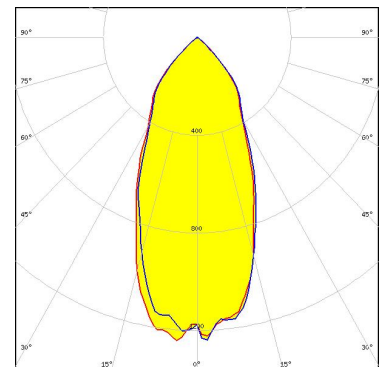

Light distribution files

OPTICAL RESULTS (SIMULATED):

	
LED	CxM-14 (19x19)
FWHM / FWTM	52.0° / 98.0°
Efficiency	92 %
Peak intensity	1 cd/lm
LEDs/each optic	1
Light colour/type	White
Required components: C13658_CLAMP-VERO13-18	
Bender Wirth: 433 Typ L1	Light distribution files

	
LED	CxM-9 (13.5x13.5)
FWHM / FWTM	45.0° / 98.0°
Efficiency	93 %
Peak intensity	1.1 cd/lm
LEDs/each optic	1
Light colour/type	White
Required components: C13658_CLAMP-VERO13-18	
Bender Wirth: 434 Typ L1	Light distribution files

 SEOUL SEMICONDUCTOR	
LED	ZC12/18
FWHM / FWTM	52.0° / 98.0°
Efficiency	92 %
Peak intensity	1 cd/lm
LEDs/each optic	1
Light colour/type	White
Required components: C13658_CLAMP-VERO13-18	
Bender Wirth: 433 Typ L1	

OPTICAL RESULTS (SIMULATED):



SEOUL SEMICONDUCTOR

LED	ZC4/6
FWHM / FWTM	45.0° / 98.0°
Efficiency	93 %
Peak intensity	1.1 cd/lm
LEDs/each optic	1
Light colour/type	White

Required components:

C13658_CLAMP-VERO13-18

Bender Wirth: 434 Typ L1

GENERAL INFORMATION:

NOTE: The typical beam angle will be changed by different color, chip size and chip position tolerance. The typical total beam angle is the full angle measured where the luminous intensity is half of the peak value.

Due to use of high power COB's with this product, special attention to proper thermal design is highly recommended. LEDiL has no liability for direct, indirect or consecutive damages arising from the LEDiL products being used outside of the recommended temperature range.

MATERIALS:

As part of our continuous research and improvement processes, and to ensure the best possible quality and availability of our products, LEDiL reserves the right to change material grades without notice.

PRODUCT DATA USER AGREEMENT AND DISCLAIMER:

The measured data in the provided downloadable LEDiL Product Datasheets and Mechanical 2D-Drawings is rounded and provided as reference for planning. LEDiL Oy's optical specifications have been verified by conducting performance testing of the products in accordance with the company's quality system. The reported data are averaged results of multiple measurements with typical variation. LEDiL Oy reserves the right to without prior notification make changes and improvements to its products.

LEDiL Oy assumes neither warranty, nor guarantee nor any other liability of any kind for the contents and correctness of the provided data. The provided data has been generated with highest diligence but the provided data may in reality not represent the complete possible variation range of all intrinsic parameters. Therefore, in certain cases a deviation from the provided data could occur.

LEDiL Oy reserves the right to undertake technical changes of its products without further notification which could lead to changes in the provided data. LEDiL Oy assumes no liability of any kind for the possible deviation from any provided data or any other damage resulting from the usage of the provided data.

The user agrees to this disclaimer and user agreement with the download or usage of the provided files.

LEDiL Oy

Joensuunkatu 7
FI-24240 SALO
Finland

LEDiL Inc.

228 West Page Street
Suite D
Sycamore IL 60178
USA

Ledil Optics Technology (Shenzhen) Co., Ltd.

405 , Block B
Casic Motor Building
Shenzhen 518057
P.R.CHINA

Local sales and technical support

[www.ledil.com/
where_to_buy](http://www.ledil.com/where_to_buy)

Shipping locations

Poznan, Poland
Hong Kong, China

Distribution Partners

[www.ledil.com/
where_to_buy](http://www.ledil.com/where_to_buy)