

BARBARA-XW-PF

White version with ~75° wide beam

SPECIFICATION:

Dimensions	Ø 70.0
Height	41.7 mm
Fastening	socket
ROHS compliant	yes ⓘ

MATERIALS:

Component	Type	Material	Colour	Finish	Coating
BARBARA-XW-PF	Reflector	HRPC	white		

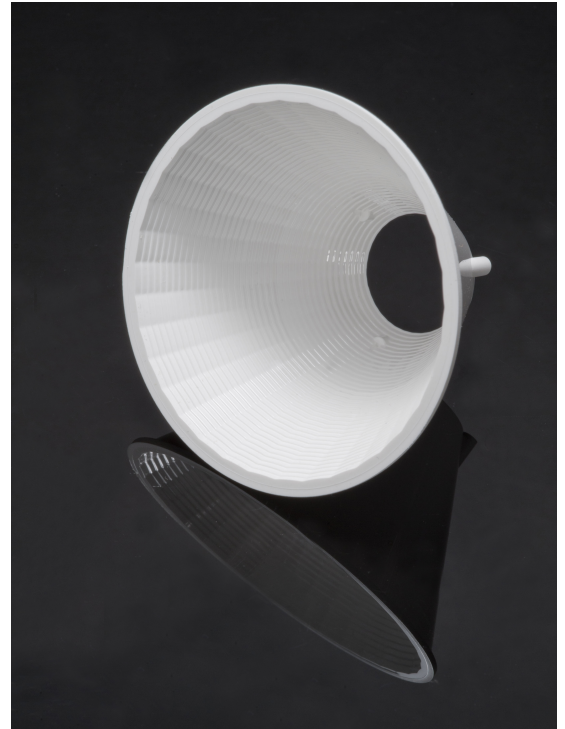

ORDERING INFORMATION:

Component	Qty in box	MOQ	MPQ	Box weight (kg)
F13703_BARBARA-XW-PF » Box size: 480 x 280 x 300 mm	288	90	18	6.1

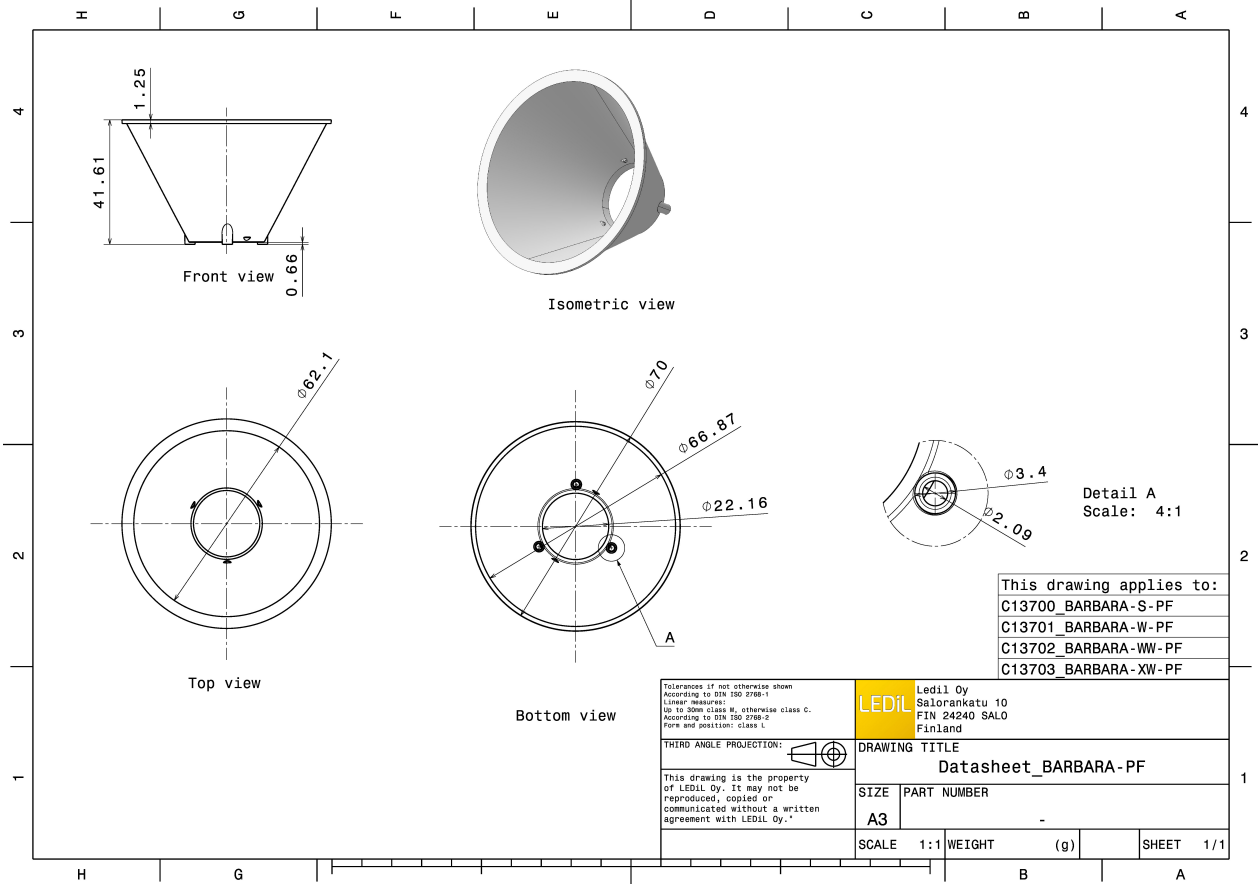

See also our general installation guide: www.ledil.com/installation_guide

OPTICAL RESULTS (MEASURED):

bridgelux

LED V10 Gen7
 FWHM / FWTM 70.0° / 111.0°
 Efficiency 90 %
 Peak intensity 0.7 cd/lm
 LEDs/each optic 1
 Light colour/type White

Required components:

C13709_PF-SOCKET-VERO13-18
 Bender Wirth: 434 Typ L1

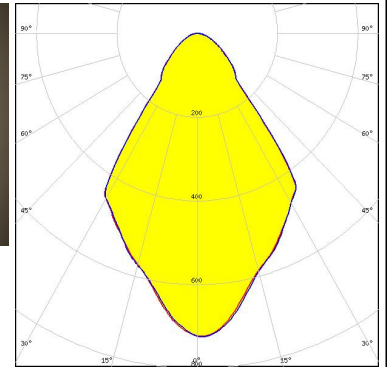
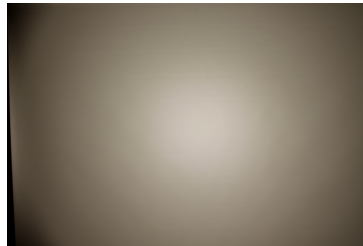

Light distribution files

bridgelux

LED V15 Gen6
 FWHM / FWTM 71.0° / 116.0°
 Efficiency 89 %
 Peak intensity 0.7 cd/lm
 LEDs/each optic 1
 Light colour/type White

Required components:

C13709_PF-SOCKET-VERO13-18
 Bender Wirth: 456 Typ L2

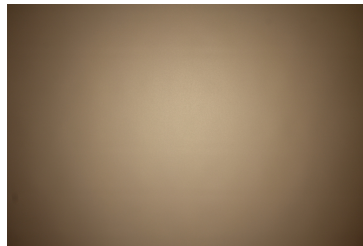

Light distribution files

bridgelux

LED V8 Gen6
 FWHM / FWTM 74.0° / 119.0°
 Efficiency 90 %
 Peak intensity 0.6 cd/lm
 LEDs/each optic 1
 Light colour/type White

Required components:

C13761_PF-SOCKET-CXA15

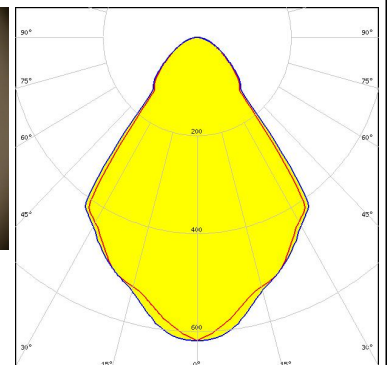
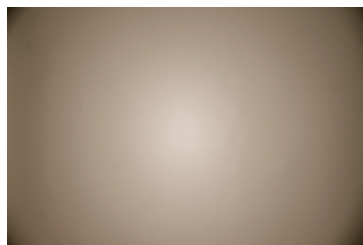

Light distribution files

OPTICAL RESULTS (MEASURED):



LED VERO13
FWHM / FWTM 72.0° / 116.0°
Efficiency 93 %
Peak intensity 0.7 cd/lm
LEDs/each optic 1
Light colour/type White
Required components:
 C13709_PF-SOCKET-VERO13-18

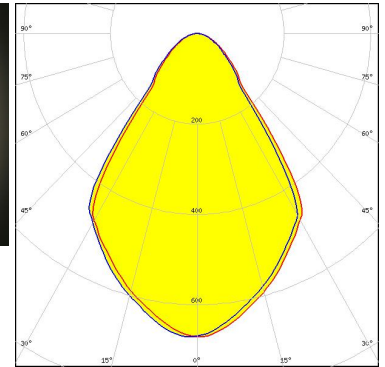
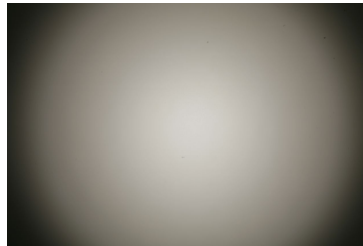

Light distribution files



LED VERO18
FWHM / FWTM 72.0° / 116.0°
Efficiency 93 %
Peak intensity 0.6 cd/lm
LEDs/each optic 1
Light colour/type White
Required components:
 C13709_PF-SOCKET-VERO13-18

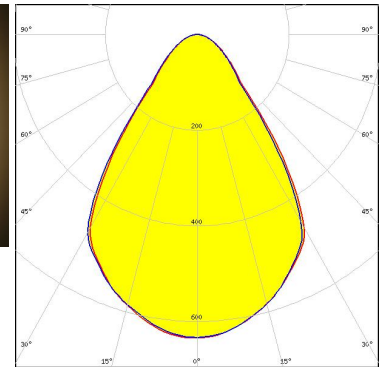
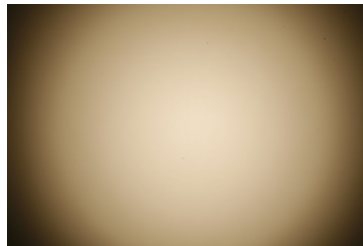

Light distribution files



LED Xenio Point 13mm
FWHM / FWTM 71.0° / 114.0°
Efficiency 92 %
Peak intensity 0.7 cd/lm
LEDs/each optic 1
Light colour/type White
Required components:
 C13709_PF-SOCKET-VERO13-18

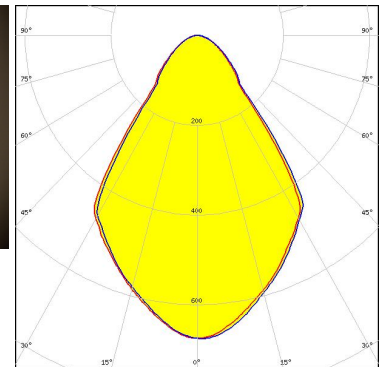
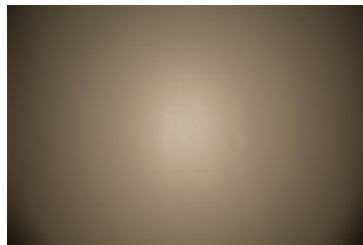

Light distribution files

OPTICAL RESULTS (MEASURED):



LED Xenio Point 18mm
FWHM / FWTM 72.0° / 115.0°
Efficiency 91 %
Peak intensity 0.6 cd/lm
LEDs/each optic 1
Light colour/type White
Required components:
 C13709_PF-SOCKET-VERO13-18

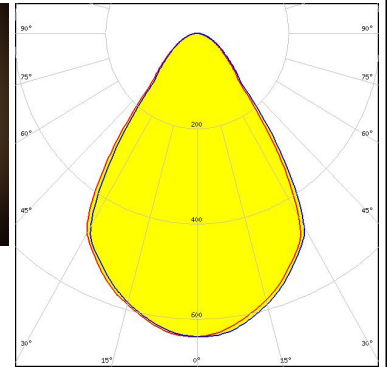
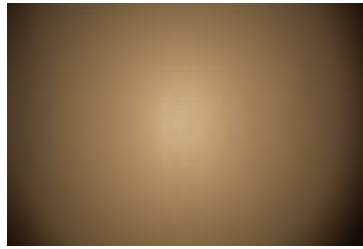

Light distribution files

CITIZEN

LED CLL02x/CLU02x (LES10)
FWHM / FWTM 70.0° / 111.0°
Efficiency 90 %
Peak intensity 0.7 cd/lm
LEDs/each optic 1
Light colour/type White
Required components:
 C13709_PF-SOCKET-VERO13-18
 Bender Wirth: 434 Typ L1

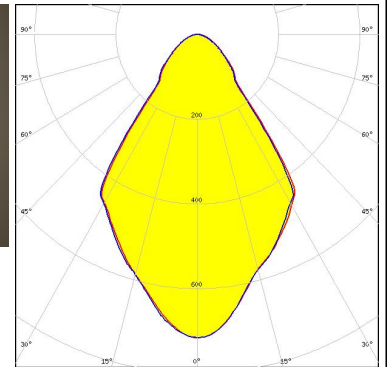

Light distribution files

CITIZEN

LED CLU700/701/702/703
FWHM / FWTM 70.0° / 109.0°
Efficiency 90 %
Peak intensity 0.8 cd/lm
LEDs/each optic 1
Light colour/type White
Required components:
 C13709_PF-SOCKET-VERO13-18
 Bender Wirth: 434 Typ L1

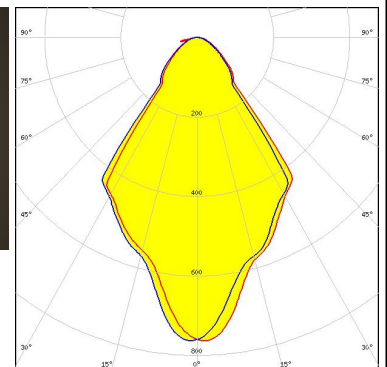
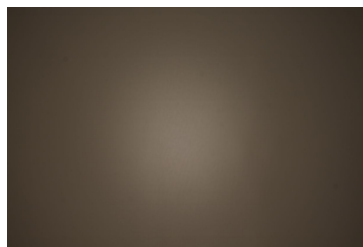

Light distribution files

OPTICAL RESULTS (MEASURED):



LED CXA/B 15xx
FWHM / FWTM 73.0° / 117.0°
Efficiency 85 %
Peak intensity 0.6 cd/lm
LEDs/each optic 1
Light colour/type White
Required components:
C13083_PF-SOCKET
C14658_BARBARA-RZ-LENS

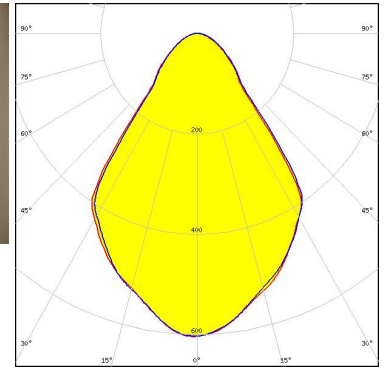
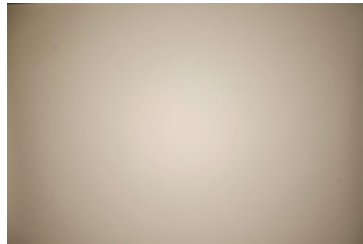

Light distribution files



LED CXA/B 15xx
FWHM / FWTM 70.0° / 110.0°
Efficiency 92 %
Peak intensity 0.8 cd/lm
LEDs/each optic 1
Light colour/type White
Required components:
C14115_PF-SOCKET-CXA15-18



LED CXA/B 15xx
FWHM / FWTM 70.0° / 111.0°
Efficiency 90 %
Peak intensity 0.7 cd/lm
LEDs/each optic 1
Light colour/type White
Required components:
C13709_PF-SOCKET-VERO13-18
Bender Wirth: 441 Typ L1

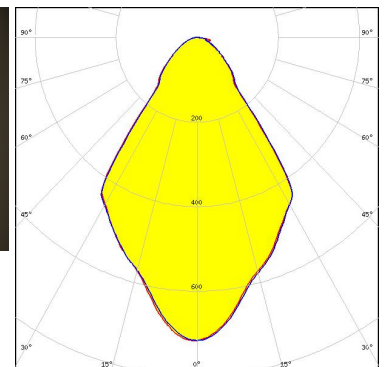
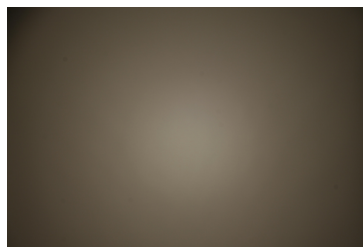

Light distribution files

OPTICAL RESULTS (MEASURED):



LED CXA/B 1816 & CXA/B 1820 & CXA 1850
 FWHM / FWTM 70.0° / 112.0°
 Efficiency 93 %
 Peak intensity 0.7 cd/lm
 LEDs/each optic 1
 Light colour/type White
 Required components:
 C14115_PF-SOCKET-CXA15-18

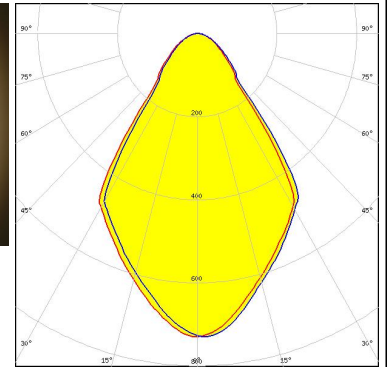
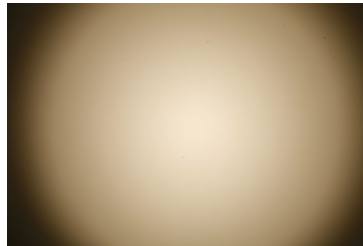

Light distribution files



LED CXA/B 1816 & CXA/B 1820 & CXA 1850
 FWHM / FWTM 67.0° / 106.0°
 Efficiency 82 %
 Peak intensity 0.7 cd/lm
 LEDs/each optic 1
 Light colour/type White
 Required components:
 C13709_PF-SOCKET-VERO13-18
 Bender Wirth: 437 Typ L1

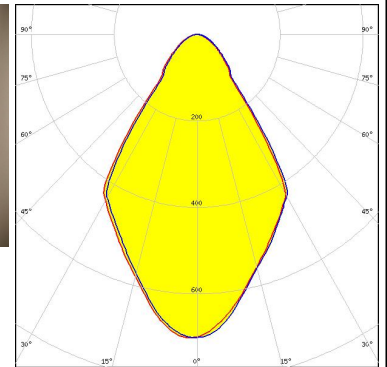
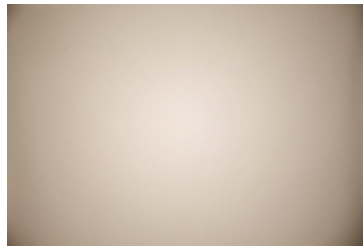

Light distribution files



LED LUXEON CoB 1202/1203
 FWHM / FWTM 71.0° / 112.0°
 Efficiency 92 %
 Peak intensity 0.7 cd/lm
 LEDs/each optic 1
 Light colour/type White
 Required components:
 C14037_PF-NSX-SOCKET

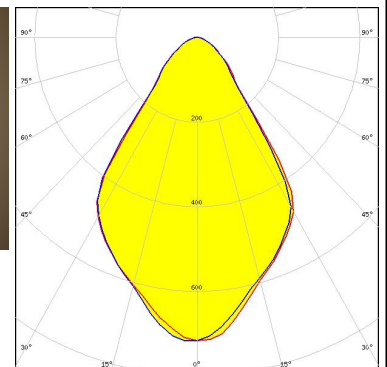
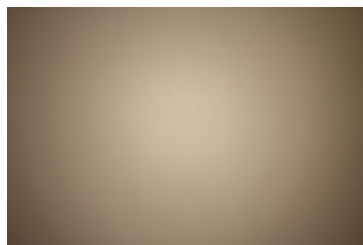

Light distribution files

OPTICAL RESULTS (MEASURED):



LED LUXEON CoB 1202/1203
FWHM / FWTM 71.0° / 112.0°
Efficiency 90 %
Peak intensity 0.7 cd/lm
LEDs/each optic 1
Light colour/type White
Required components:
C13709_PF-SOCKET-VERO13-18
Bender Wirth: 438 Typ L1

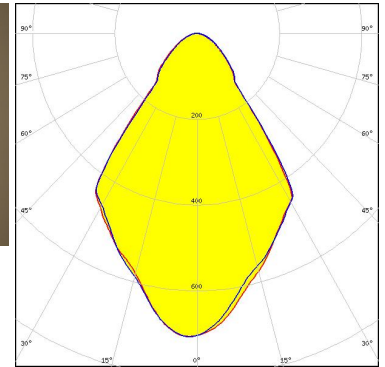
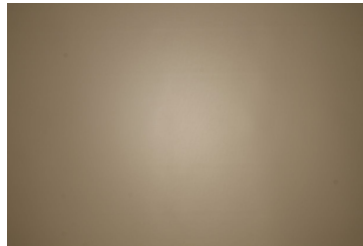

Light distribution files



LED LUXEON CoB 1202s
FWHM / FWTM 75.0° / 120.0°
Efficiency 92 %
Peak intensity 0.7 cd/lm
LEDs/each optic 1
Light colour/type White
Required components:
C13761_PF-SOCKET-CXA15

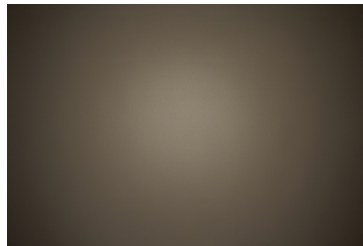

Light distribution files



LED COB J-Type
FWHM / FWTM 72.0° / 116.0°
Efficiency 93 %
Peak intensity 0.7 cd/lm
LEDs/each optic 1
Light colour/type White
Required components:
C14037_PF-NSX-SOCKET

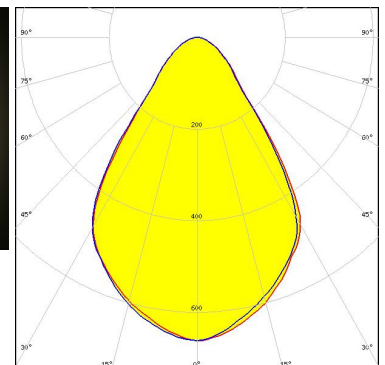
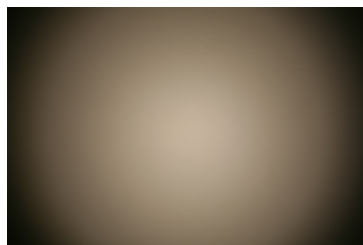

Light distribution files

OPTICAL RESULTS (MEASURED):



LED COB J-Type
FWHM / FWTM 70.0° / 112.0°
Efficiency 89 %
Peak intensity 0.7 cd/lm
LEDs/each optic 1
Light colour/type White
Required components:
C13709_PF-SOCKET-VERO13-18
Bender Wirth: 463 Typ L2

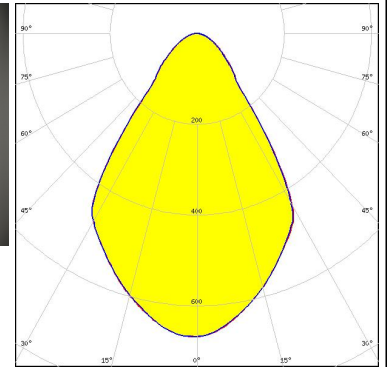

Light distribution files



LED COB L-Type (LES 11)
FWHM / FWTM 70.0° / 113.0°
Efficiency 90 %
Peak intensity 0.7 cd/lm
LEDs/each optic 1
Light colour/type White
Required components:
C13709_PF-SOCKET-VERO13-18
Bender Wirth: 438 Typ L1

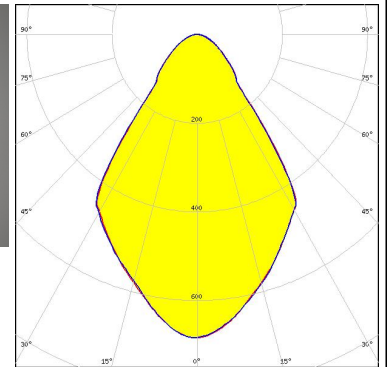

Light distribution files



LED COB L-Type (LES 11)
FWHM / FWTM 72.0° / 115.0°
Efficiency 93 %
Peak intensity 0.7 cd/lm
LEDs/each optic 1
Light colour/type White
Required components:
C14037_PF-NSX-SOCKET

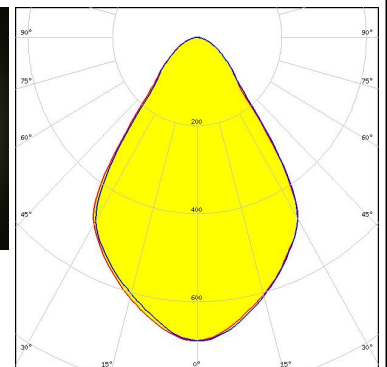
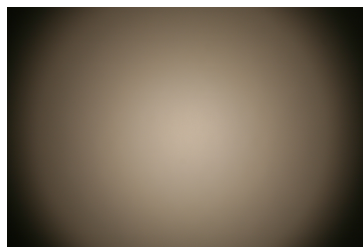

Light distribution files

OPTICAL RESULTS (MEASURED):



LED COB L-Type (LES 9)
FWHM / FWTM 72.0° / 112.0°
Efficiency 93 %
Peak intensity 0.7 cd/lm
LEDs/each optic 1
Light colour/type White
Required components:
C14037_PF-NSX-SOCKET

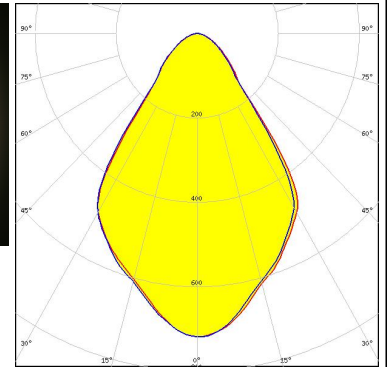

Light distribution files



LED COB L-Type (LES 9)
FWHM / FWTM 70.0° / 112.0°
Efficiency 90 %
Peak intensity 0.7 cd/lm
LEDs/each optic 1
Light colour/type White
Required components:
C13709_PF-SOCKET-VERO13-18
Bender Wirth: 438 Typ L1

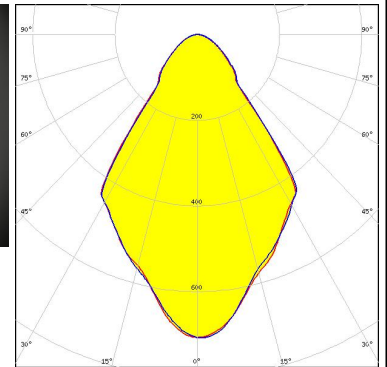
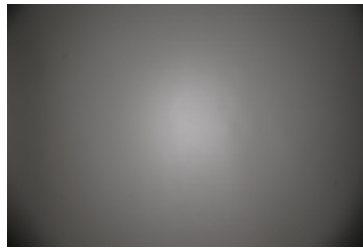

Light distribution files



LED NSCxL036A
FWHM / FWTM 71.0° / 112.0°
Efficiency 91 %
Peak intensity 0.7 cd/lm
LEDs/each optic 1
Light colour/type White
Required components:
C14037_PF-NSX-SOCKET

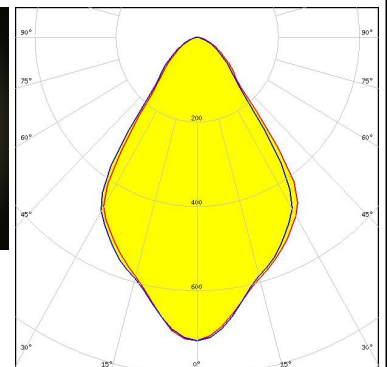
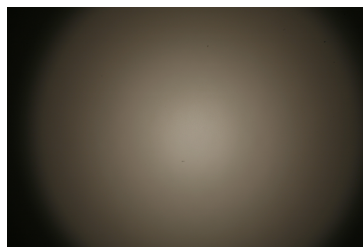

Light distribution files

OPTICAL RESULTS (MEASURED):

OSRAM
Opto Semiconductors

LED OSTAR Stage (S2WP)
FWHM / FWTM 74.0° / 120.0°
Efficiency 83 %
Peak intensity 0.6 cd/lm
LEDs/each optic 1
Light colour/type White
Required components:
C13083_PF-SOCKET
C14658_BARBARA-RZ-LENS

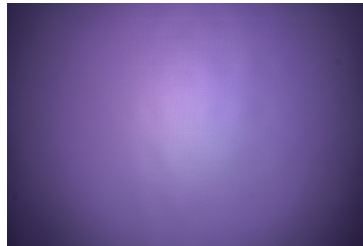

Light distribution files

OSRAM
Opto Semiconductors

LED Soleriq S13
FWHM / FWTM 70.0° / 113.0°
Efficiency 90 %
Peak intensity 0.7 cd/lm
LEDs/each optic 1
Light colour/type White
Required components:
C13709_PF-SOCKET-VERO13-18
Bender Wirth: 437 Typ L1

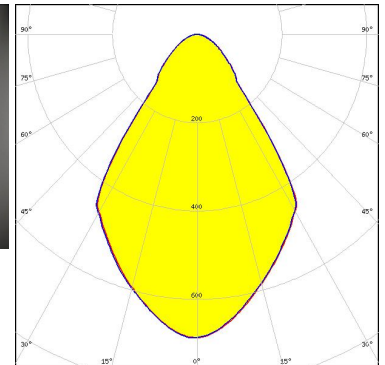
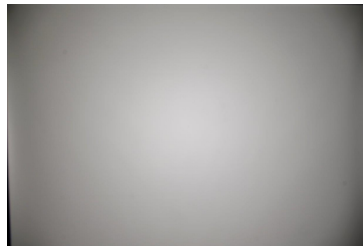

Light distribution files

SAMSUNG

LED LC026B / 033B / 040B
FWHM / FWTM 70.0° / 113.0°
Efficiency 90 %
Peak intensity 0.6 cd/lm
LEDs/each optic 1
Light colour/type White
Required components:
C13709_PF-SOCKET-VERO13-18
Bender Wirth: 450 Typ L2

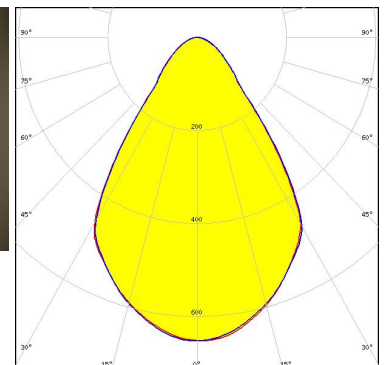
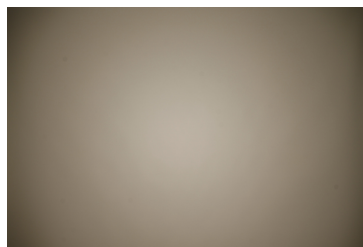

Light distribution files

OPTICAL RESULTS (MEASURED):

XICATO

LED XTM - 19mm LES
FWHM / FWTM 70.0° / 112.0°
Efficiency 83 %
Peak intensity 0.6 cd/lm
LEDs/each optic 1
Light colour/type White
Required components:
C14636_XTM-PF-ADAPTER

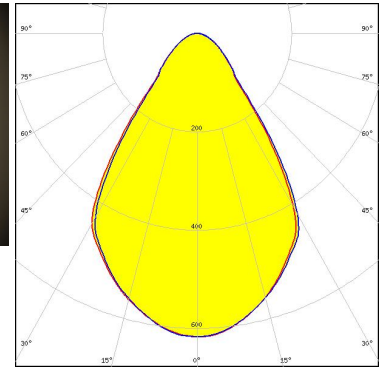
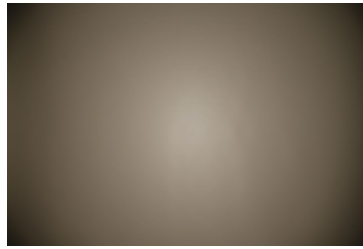

Light distribution files

XICATO

LED XTM - 9mm LES
FWHM / FWTM 70.0° / 111.0°
Efficiency 86 %
Peak intensity 0.7 cd/lm
LEDs/each optic 1
Light colour/type White
Required components:
C14636_XTM-PF-ADAPTER

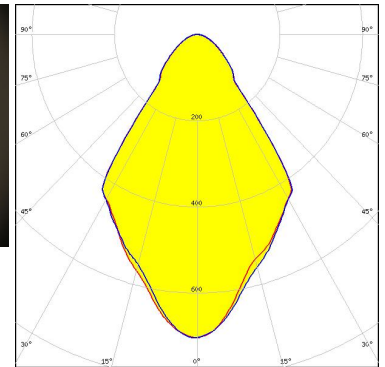
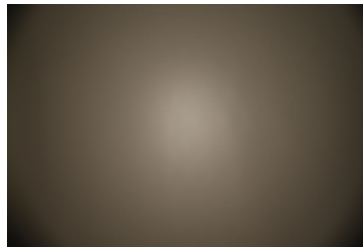

Light distribution files

OPTICAL RESULTS (SIMULATED):



LED V10 Gen7
FWHM / FWTM 66.0° / 93.0°
Efficiency 88 %
Peak intensity 0.9 cd/lm
LEDs/each optic 1
Light colour/type White

Required components:

C13709_PF-SOCKET-VERO13-18

Bender Wirth: 486 Typ L1

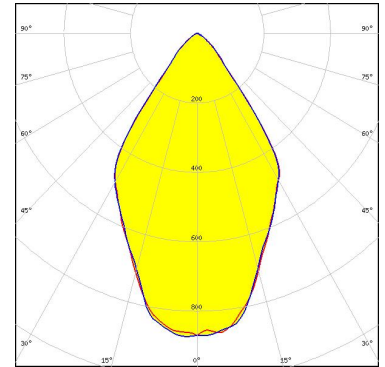

Light distribution files



LED LUXEON CoB Compact
FWHM / FWTM 75.0° / 120.0°
Efficiency 92 %
Peak intensity 0.7 cd/lm
LEDs/each optic 1
Light colour/type White

Required components:

C13761_PF-SOCKET-CXA15

Light distribution files



LED CxM-14 (19x19)
FWHM / FWTM 70.0° / 113.0°
Efficiency 90 %
Peak intensity 0.7 cd/lm
LEDs/each optic 1
Light colour/type White

Required components:

C13709_PF-SOCKET-VERO13-18

Bender Wirth: 433 Typ L1

Light distribution files

OPTICAL RESULTS (SIMULATED):



LED CxM-9 (13.5x13.5)
FWHM / FWTM 70.0° / 111.0°
Efficiency 90 %
Peak intensity 0.7 cd/lm
LEDs/each optic 1
Light colour/type White

Required components:

C13709_PF-SOCKET-VERO13-18

Bender Wirth: 434 Typ L1

[Light distribution files](#)



LED Soleriq S15
FWHM / FWTM 74.0° / 112.0°
Efficiency 95 %
Peak intensity 0.7 cd/lm
LEDs/each optic 1
Light colour/type White

Required components:

C13709_PF-SOCKET-VERO13-18

Bender Wirth: 433 Typ L1

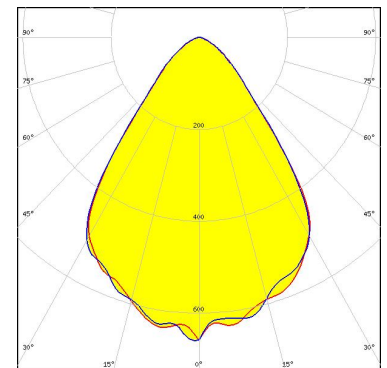

[Light distribution files](#)



LED LC010C
FWHM / FWTM 66.0° / 91.0°
Efficiency 89 %
Peak intensity 0.9 cd/lm
LEDs/each optic 1
Light colour/type White

Required components:

C13709_PF-SOCKET-VERO13-18

Bender Wirth: 479 Typ L1

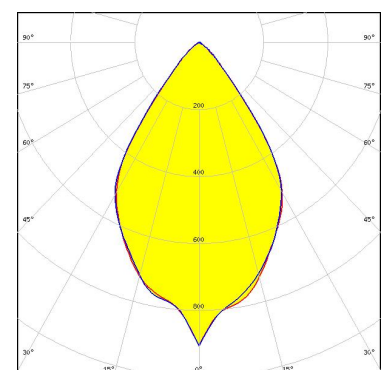

[Light distribution files](#)

OPTICAL RESULTS (SIMULATED):

SAMSUNG

LED LC020C
FWHM / FWTM 70.0° / 95.0°
Efficiency 88 %
Peak intensity 0.8 cd/lm
LEDs/each optic 1
Light colour/type White

Required components:

C13709_PF-SOCKET-VERO13-18

Bender Wirth: 479 Typ L1

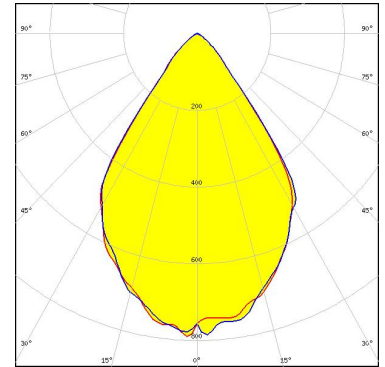

Light distribution files

SAMSUNG

LED LC040C
FWHM / FWTM 70.0° / 96.0°
Efficiency 84 %
Peak intensity 0.7 cd/lm
LEDs/each optic 1
Light colour/type White

Required components:

C13709_PF-SOCKET-VERO13-18

Bender Wirth: 480 Typ L1

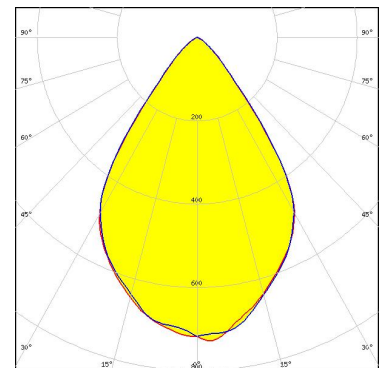

Light distribution files



SEOUL SEMICONDUCTOR

LED ZC12/18
FWHM / FWTM 70.0° / 113.0°
Efficiency 90 %
Peak intensity 0.7 cd/lm
LEDs/each optic 1
Light colour/type White

Required components:

C13709_PF-SOCKET-VERO13-18

Bender Wirth: 433 Typ L1

OPTICAL RESULTS (SIMULATED):

 SEUL SEMICONDUCTOR	
LED	ZC4/6
FWHM / FWTM	70.0° / 111.0°
Efficiency	90 %
Peak intensity	0.7 cd/lm
LEDs/each optic	1
Light colour/type	White
Required components: C13709_PF-SOCKET-VERO13-18	
Bender Wirth: 434 Typ L1	

GENERAL INFORMATION:

NOTE: The typical beam angle will be changed by different color, chip size and chip position tolerance. The typical total beam angle is the full angle measured where the luminous intensity is half of the peak value.

Due to use of high power COB's with this product, special attention to proper thermal design is highly recommended. LEDiL has no liability for direct, indirect or consecutive damages arising from the LEDiL products being used outside of the recommended temperature range.

MATERIALS:

As part of our continuous research and improvement processes, and to ensure the best possible quality and availability of our products, LEDiL reserves the right to change material grades without notice.

PRODUCT DATA USER AGREEMENT AND DISCLAIMER:

The measured data in the provided downloadable LEDiL Product Datasheets and Mechanical 2D-Drawings is rounded and provided as reference for planning. LEDiL Oy's optical specifications have been verified by conducting performance testing of the products in accordance with the company's quality system. The reported data are averaged results of multiple measurements with typical variation. LEDiL Oy reserves the right to without prior notification make changes and improvements to its products.

LEDiL Oy assumes neither warranty, nor guarantee nor any other liability of any kind for the contents and correctness of the provided data. The provided data has been generated with highest diligence but the provided data may in reality not represent the complete possible variation range of all intrinsic parameters. Therefore, in certain cases a deviation from the provided data could occur.

LEDiL Oy reserves the right to undertake technical changes of its products without further notification which could lead to changes in the provided data. LEDiL Oy assumes no liability of any kind for the possible deviation from any provided data or any other damage resulting from the usage of the provided data.

The user agrees to this disclaimer and user agreement with the download or usage of the provided files.

LEDiL Oy

Joensuunkatu 7
FI-24240 SALO
Finland

LEDiL Inc.

228 West Page Street
Suite D
Sycamore IL 60178
USA

Ledil Optics Technology (Shenzhen) Co., Ltd.

405 , Block B
Casic Motor Building
Shenzhen 518057
P.R.CHINA

Local sales and technical support

[www.ledil.com/
where_to_buy](http://www.ledil.com/where_to_buy)

Shipping locations

Poznan, Poland
Hong Kong, China

Distribution Partners

[www.ledil.com/
where_to_buy](http://www.ledil.com/where_to_buy)