

## CARMEN-SS-C

~12° smooth spot beam. Assembly with holder C compatible with LEDiL HEKLA. Updated version with good colour mixing capability.

### SPECIFICATION:

Dimensions	Ø 69.5 mm
Height	41.5 mm
Fastening	socket
ROHS compliant	yes ⓘ



### MATERIALS:

Component	Type	Material	Colour	Finish	Length
CARMEN-SS	Single lens	PMMA	clear		66.4
CARMEN-HLD-C	Holder	PC	black		69.5

### ORDERING INFORMATION:

Component		Qty in box	MOQ	MPQ	Box weight (kg)
CP16601_CARMEN-SS-C	Single lens	150	150	15	8.4
» Box size: 480 x 280 x 300 mm					

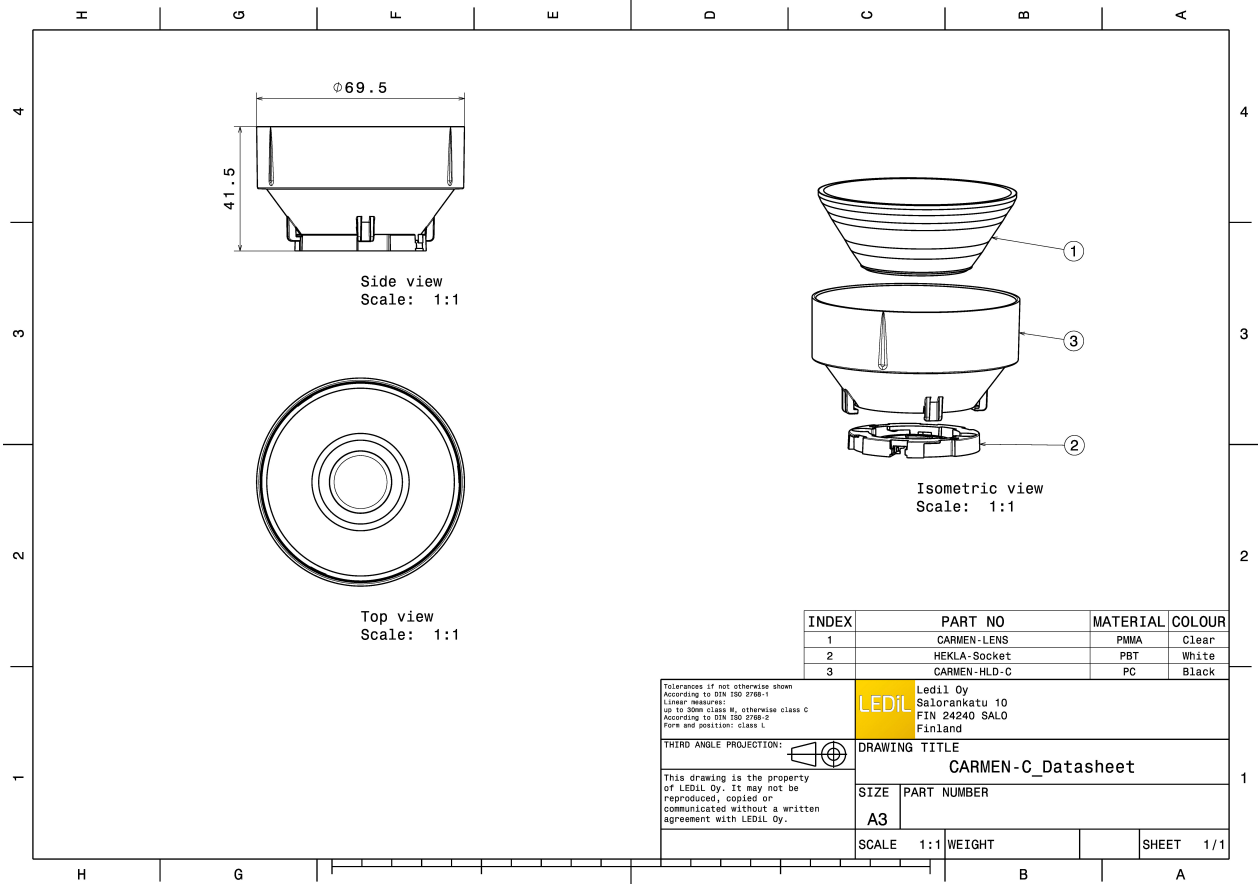

See also our general installation guide: [www.ledil.com/installation\\_guide](http://www.ledil.com/installation_guide)

### OPTICAL RESULTS (MEASURED):



**LED** Vesta TW 6mm DP  
**FWHM / FWTM** 11.0° / 21.0°  
**Efficiency** 60 %  
**Peak intensity** 11 cd/lm  
**LEDs/each optic** 1  
**Light colour/type** White  
**Required components:**  
 C16142\_HEKLA-SOCKET-K  
 Bender Wirth: 504 Typ L8

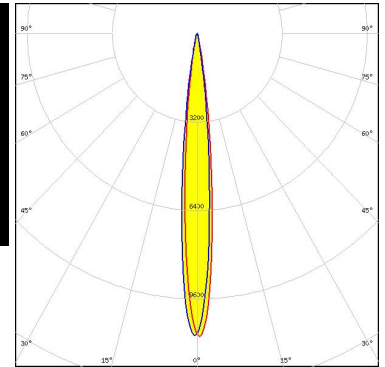

Light distribution files



**LED** Vesta TW 9mm (9W) DP  
**FWHM / FWTM** 13.0° / 25.0°  
**Efficiency** 58 %  
**Peak intensity** 7 cd/lm  
**LEDs/each optic** 1  
**Light colour/type** White  
**Required components:**  
 C16142\_HEKLA-SOCKET-K  
 Bender Wirth: 489 Typ L8

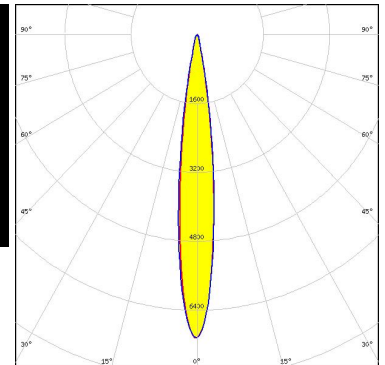

Light distribution files

### CITIZEN

**LED** CLL02x/CLU02x (LES10)  
**FWHM / FWTM** 13.0° / 25.0°  
**Efficiency** 61 %  
**Peak intensity** 8 cd/lm  
**LEDs/each optic** 1  
**Light colour/type** White  
**Required components:**  
 F15255\_HEKLA-SOCKET-C

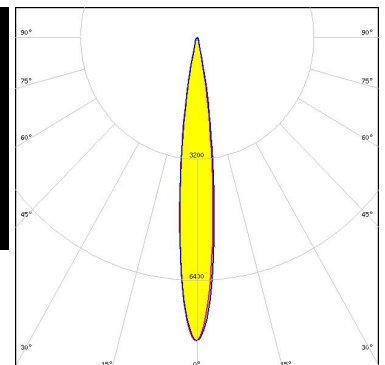
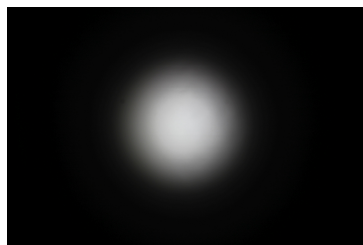

Light distribution files

### OPTICAL RESULTS (MEASURED):

#### CITIZEN

LED CLU700/701/702/703  
FWHM / FWTM 10.0° / 20.0°  
Efficiency 64 %  
Peak intensity 13.9 cd/lm  
LEDs/each optic 1  
Light colour/type White  
Required components:  
F15255\_HEKLA-SOCKET-C

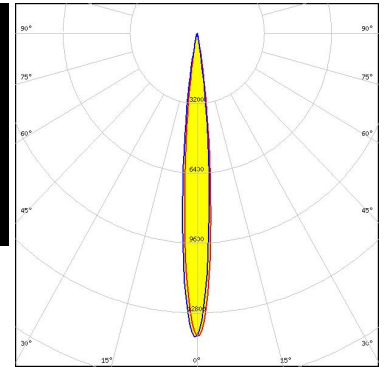
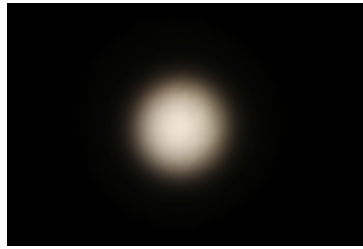

Light distribution files

#### CITIZEN

LED CLU710/711  
FWHM / FWTM 12.0° / 24.0°  
Efficiency 60 %  
Peak intensity 8.8 cd/lm  
LEDs/each optic 1  
Light colour/type White  
Required components:  
F15859\_HEKLA-SOCKET-I

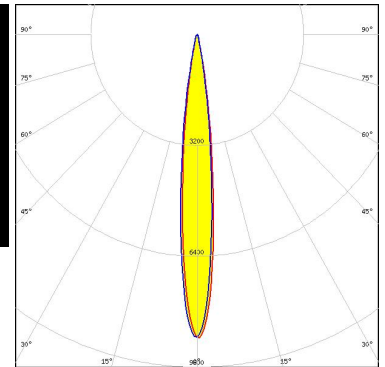
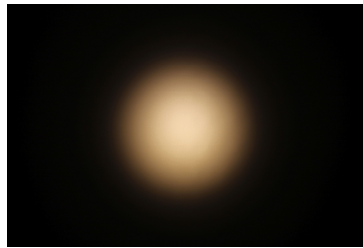

Light distribution files

#### CITIZEN

LED CLU7B2  
FWHM / FWTM 10.0° / 18.0°  
Efficiency 66 %  
Peak intensity 15.6 cd/lm  
LEDs/each optic 1  
Light colour/type White  
Required components:  
F15255\_HEKLA-SOCKET-C

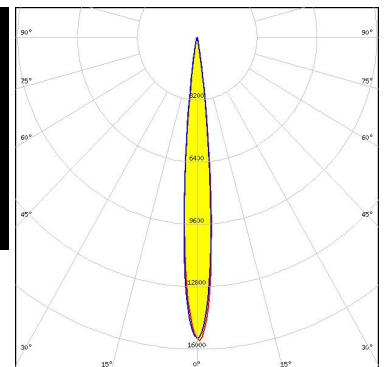
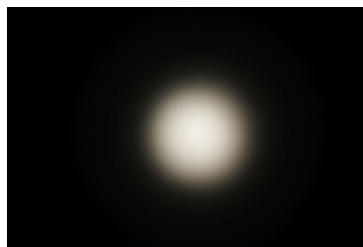

Light distribution files



### OPTICAL RESULTS (MEASURED):



LED CXA/B 13xx  
FWHM / FWTM 11.0° / 20.0°  
Efficiency 66 %  
Peak intensity 13.8 cd/lm  
LEDs/each optic 1  
Light colour/type White  
Required components:  
F15956\_HEKLA-SOCKET-J

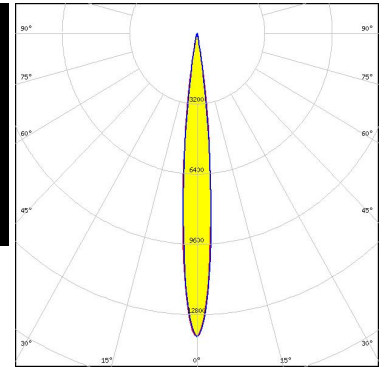
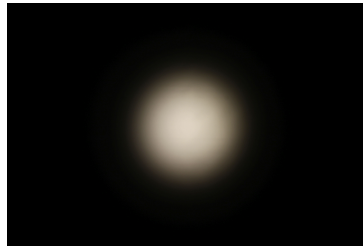

Light distribution files



LED LUXEON CX Plus CoB L08 (Gen2)  
FWHM / FWTM 19.0° / 32.0°  
Efficiency 57 %  
Peak intensity 4 cd/lm  
LEDs/each optic 1  
Light colour/type White  
Required components:  
Bender Wirth: 637a Hekla

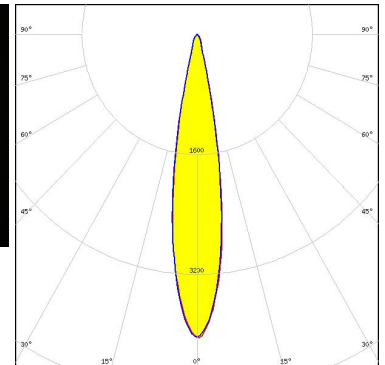
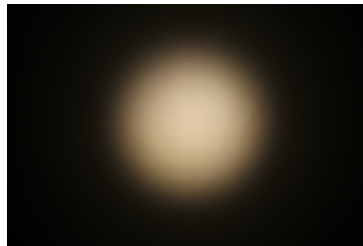

Light distribution files



LED LUXEON CX Plus CoB - HD S01H4  
FWHM / FWTM 11.0° / 19.0°  
Efficiency 65 %  
Peak intensity 14.6 cd/lm  
LEDs/each optic 1  
Light colour/type White  
Required components:  
Bender Wirth: 634c Hekla

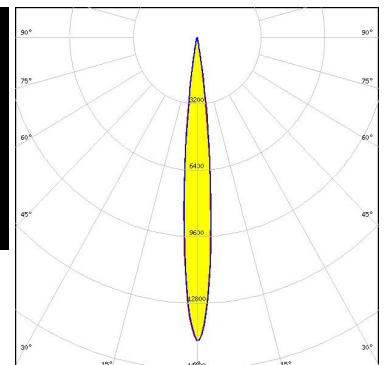

Light distribution files

#### OPTICAL RESULTS (MEASURED):



LED LUXEON CX Plus CoB - HD S02H6  
 FWHM / FWTM 11.0° / 19.0°  
 Efficiency 64 %  
 Peak intensity 14.2 cd/lm  
 LEDs/each optic 1  
 Light colour/type White  
 Required components:  
 Bender Wirth: 634c Hekla

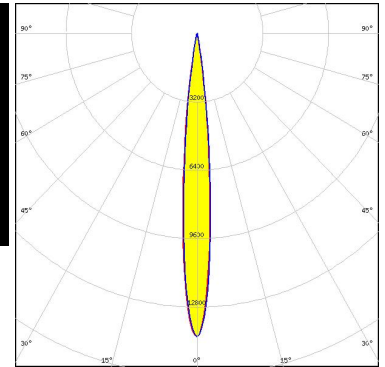
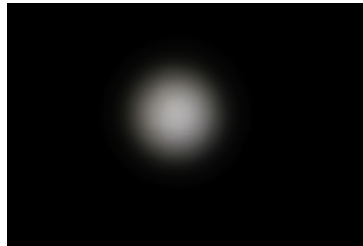

Light distribution files



LED LUXEON CX Plus CoB - HD S04H9  
 FWHM / FWTM 13.0° / 24.0°  
 Efficiency 61 %  
 Peak intensity 8.9 cd/lm  
 LEDs/each optic 1  
 Light colour/type White  
 Required components:  
 Bender Wirth: 634c Hekla

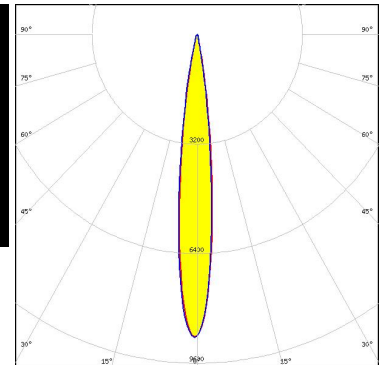

Light distribution files



LED LUXEON CX Plus CoB L04 / L05 (Gen2)  
 FWHM / FWTM 16.0° / 27.0°  
 Efficiency 60 %  
 Peak intensity 6.1 cd/lm  
 LEDs/each optic 1  
 Light colour/type White  
 Required components:  
 Bender Wirth: 637a Hekla

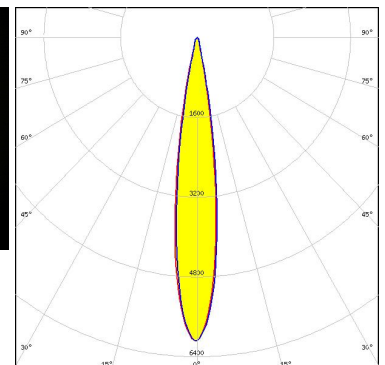

Light distribution files

#### OPTICAL RESULTS (MEASURED):



LED LUXEON CX Plus CoB M02 / M03 (Gen2)  
 FWHM / FWTM 12.0° / 23.0°  
 Efficiency 62 %  
 Peak intensity 9.8 cd/lm  
 LEDs/each optic 1  
 Light colour/type White  
 Required components:  
 Bender Wirth: 641a Hekla

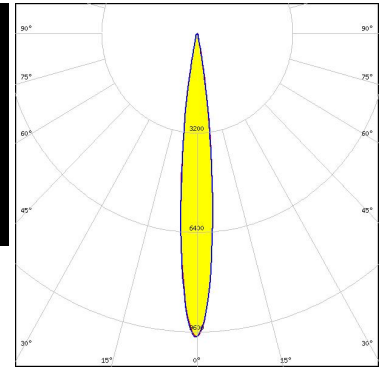

Light distribution files



LED LUXEON CX Plus CoB S01 (Gen2)  
 FWHM / FWTM 10.0° / 19.0°  
 Efficiency 65 %  
 Peak intensity 14.8 cd/lm  
 LEDs/each optic 1  
 Light colour/type White  
 Required components:  
 Bender Wirth: 634c Hekla

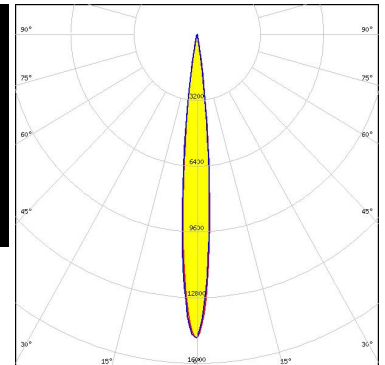
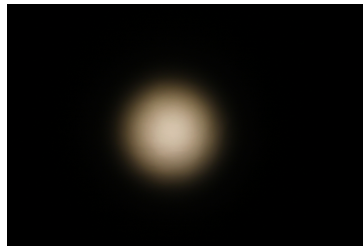

Light distribution files



LED CDM-9 (Dim-To-Warm)  
 FWHM / FWTM 13.0° / 23.0°  
 Efficiency 60 %  
 Peak intensity 8.9 cd/lm  
 LEDs/each optic 1  
 Light colour/type White  
 Required components:  
 C16142\_HEKLA-SOCKET-K  
 Bender Wirth: 490 Typ L8

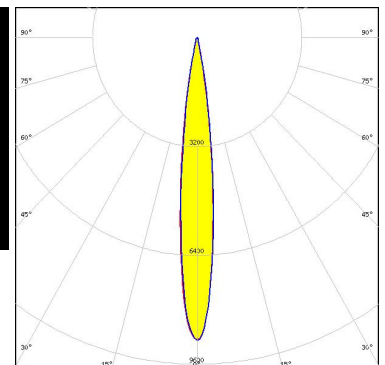

Light distribution files

### OPTICAL RESULTS (MEASURED):



LED CxM-11 (19x19)  
 FWHM / FWTM 16.0° / 29.0°  
 Efficiency 58 %  
 Peak intensity 5.3 cd/lm  
 LEDs/each optic 1  
 Light colour/type White  
 Required components:  
 F15859\_HEKLA-SOCKET-I

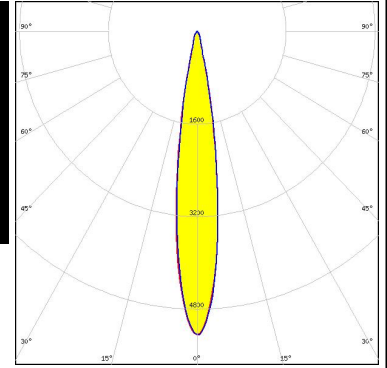

Light distribution files



LED CXM-3  
 FWHM / FWTM 10.0° / 18.0°  
 Efficiency 66 %  
 Peak intensity 15.2 cd/lm  
 LEDs/each optic 1  
 Light colour/type White  
 Required components:  
 F15255\_HEKLA-SOCKET-C

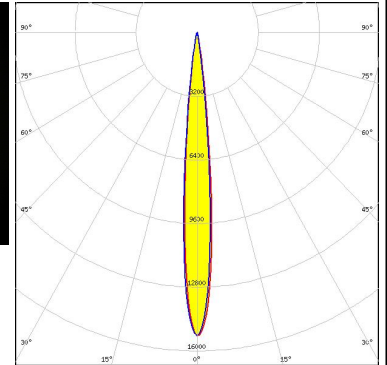

Light distribution files



LED CXM-4  
 FWHM / FWTM 10.0° / 19.0°  
 Efficiency 63 %  
 Peak intensity 13.4 cd/lm  
 LEDs/each optic 1  
 Light colour/type White  
 Required components:  
 F15255\_HEKLA-SOCKET-C

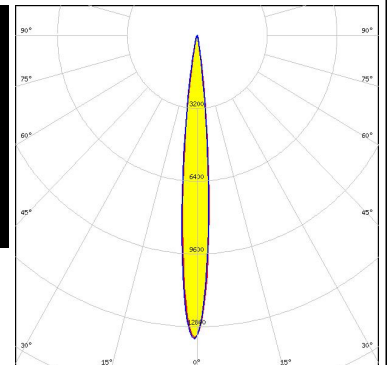

Light distribution files

#### OPTICAL RESULTS (MEASURED):



LED NJCWL024Z-V1MT: COB L-Type Tunable White  
FWHM / FWTM 11.0° / 21.0°  
Efficiency 58 %  
Peak intensity 11 cd/lm  
LEDs/each optic 1  
Light colour/type White  
Required components:  
C16142\_HEKLA-SOCKET-K  
Bender Wirth: 497 Typ L8

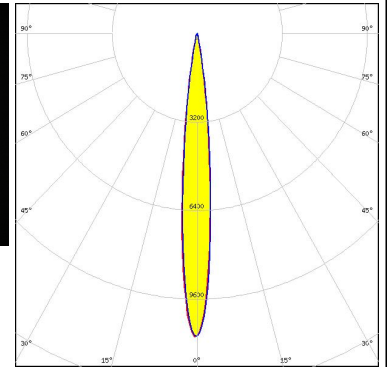

Light distribution files

#### XICATO

LED XOB 6 mm  
FWHM / FWTM 10.0° / 20.0°  
Efficiency 62 %  
Peak intensity 12.5 cd/lm  
LEDs/each optic 1  
Light colour/type White  
Required components:  
F15255\_HEKLA-SOCKET-C

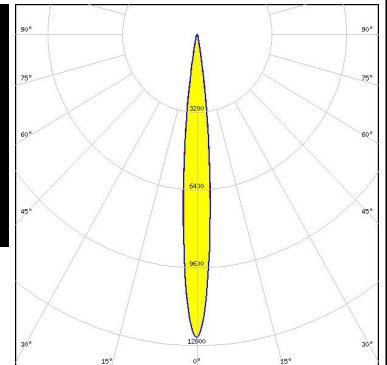
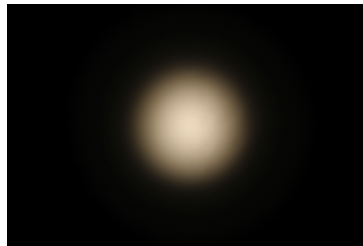

Light distribution files

#### XICATO

LED XOB 9.8 mm  
FWHM / FWTM 13.0° / 24.0°  
Efficiency 60 %  
Peak intensity 8.2 cd/lm  
LEDs/each optic 1  
Light colour/type White  
Required components:  
F15255\_HEKLA-SOCKET-C

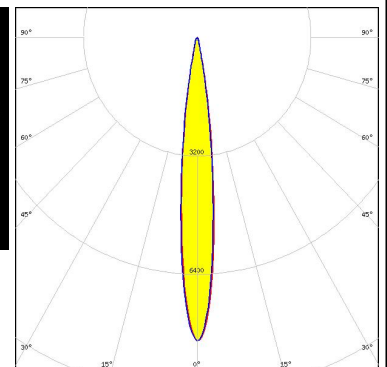

Light distribution files

#### OPTICAL RESULTS (SIMULATED):



**LED** VERO13  
**FWHM / FWTM** 16.0° / 34.0°  
**Efficiency** 65 %  
**Peak intensity** 4.6 cd/lm  
**LEDs/each optic** 1  
**Light colour/type** White  
**Required components:**  
 C16142\_HEKLA-SOCKET-K

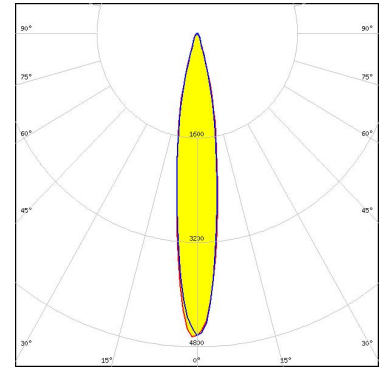

Light distribution files

#### CITIZEN

**LED** CLL02x/CLU02x (LES10)  
**FWHM / FWTM** 14.0° / 26.0°  
**Efficiency** 45 %  
**Peak intensity** 6.8 cd/lm  
**LEDs/each optic** 1  
**Light colour/type** White  
**Required components:**  
 F15859\_HEKLA-SOCKET-I  
 C16752\_CARMEN-70-SHD

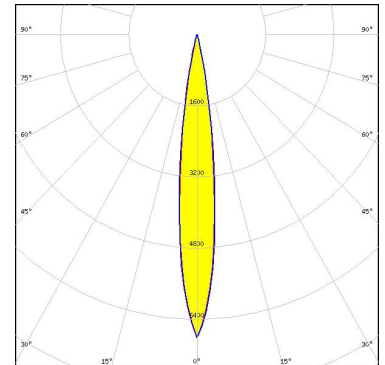

Light distribution files

#### CITIZEN

**LED** CLU700/701/702/703  
**FWHM / FWTM** 10.0° / 19.0°  
**Efficiency** 51 %  
**Peak intensity** 14.2 cd/lm  
**LEDs/each optic** 1  
**Light colour/type** White  
**Required components:**  
 F15255\_HEKLA-SOCKET-C  
 C16752\_CARMEN-70-SHD

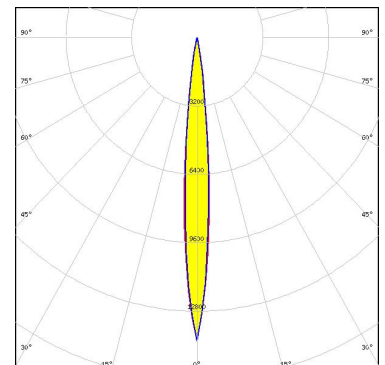

Light distribution files

#### OPTICAL RESULTS (SIMULATED):

### CITIZEN

LED CLU700/701/702/703  
FWHM / FWTM 10.0° / 20.0°  
Efficiency 69 %  
Peak intensity 17.4 cd/lm  
LEDs/each optic 1  
Light colour/type White  
Required components:  
F15255\_HEKLA-SOCKET-C

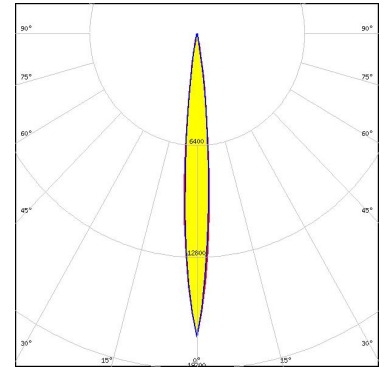

Light distribution files

### CITIZEN

LED CLU712/713  
FWHM / FWTM 12.0° / 24.0°  
Efficiency 65 %  
Peak intensity 9.8 cd/lm  
LEDs/each optic 1  
Light colour/type White  
Required components:  
F15859\_HEKLA-SOCKET-I

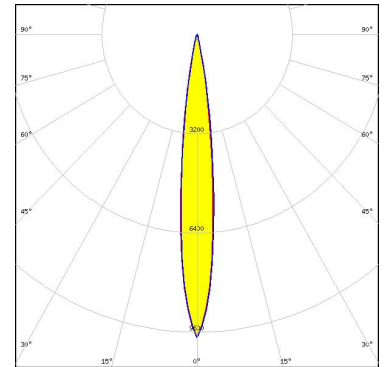

Light distribution files

### CITIZEN

LED CLU712/713  
FWHM / FWTM 12.0° / 24.0°  
Efficiency 47 %  
Peak intensity 8.1 cd/lm  
LEDs/each optic 1  
Light colour/type White  
Required components:  
F15859\_HEKLA-SOCKET-I  
C16752\_CARMEN-70-SHD

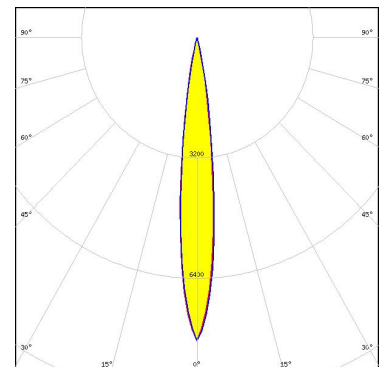

Light distribution files



#### OPTICAL RESULTS (SIMULATED):



LED CMA1825  
 FWHM / FWTM 17.0° / 32.0°  
 Efficiency 69 %  
 Peak intensity 5.4 cd/lm  
 LEDs/each optic 1  
 Light colour/type White  
 Required components:

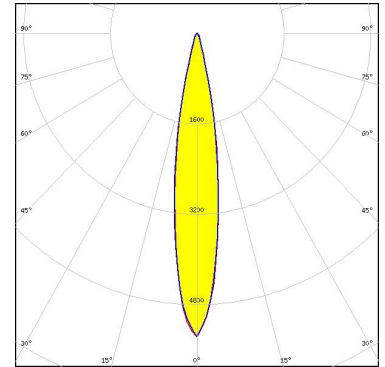

Light distribution files



LED CMA1840  
 FWHM / FWTM 19.0° / 37.0°  
 Efficiency 66 %  
 Peak intensity 4 cd/lm  
 LEDs/each optic 1  
 Light colour/type White  
 Required components:

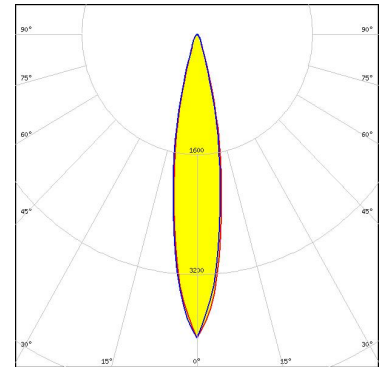

Light distribution files



LED CXA/B 15xx  
 FWHM / FWTM 12.0° / 23.0°  
 Efficiency 68 %  
 Peak intensity 11.1 cd/lm  
 LEDs/each optic 1  
 Light colour/type White  
 Required components:  
 F15256\_HEKLA-SOCKET-D

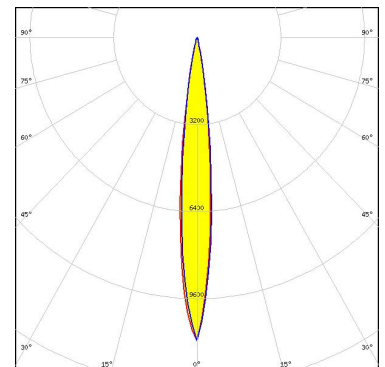

Light distribution files

### OPTICAL RESULTS (SIMULATED):



LED CXM-4  
FWHM / FWTM 8.0° / 18.0°  
Efficiency 52 %  
Peak intensity 16.8 cd/lm  
LEDs/each optic 1  
Light colour/type White

Required components:

F17435\_HEKLA-G2-C  
C16752\_CARMEN-70-SHD

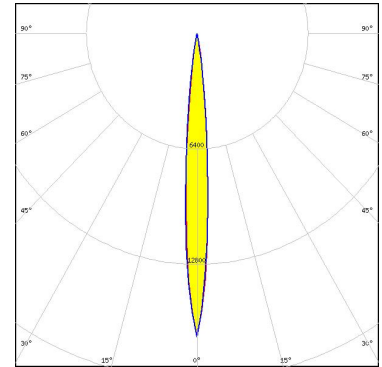

Light distribution files



LED CxM-6 (13.5x13.5)  
FWHM / FWTM 10.0° / 20.0°  
Efficiency 68 %  
Peak intensity 14.7 cd/lm  
LEDs/each optic 1  
Light colour/type White

Required components:

F17435\_HEKLA-G2-C

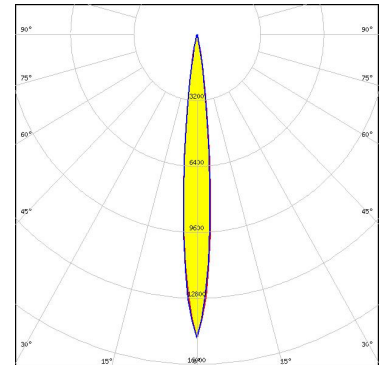

Light distribution files



LED LC003D / LC006D / LC009D / LC013D  
FWHM / FWTM 14.0° / 26.0°  
Efficiency 63 %  
Peak intensity 8 cd/lm  
LEDs/each optic 1  
Light colour/type White

Required components:

F17435\_HEKLA-G2-C

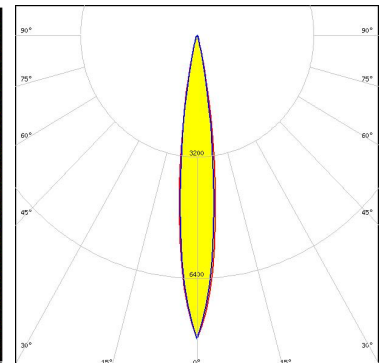

Light distribution files

#### OPTICAL RESULTS (SIMULATED):

### SAMSUNG

LED LC003D / LC006D / LC009D / LC013D  
FWHM / FWTM 14.0° / 26.0°  
Efficiency 62 %  
Peak intensity 7.5 cd/lm  
LEDs/each optic 1  
Light colour/type White  
Required components:  
F17435\_HEKLA-G2-C

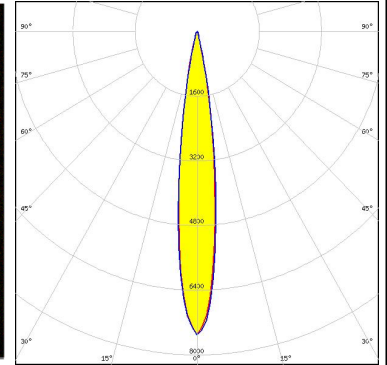
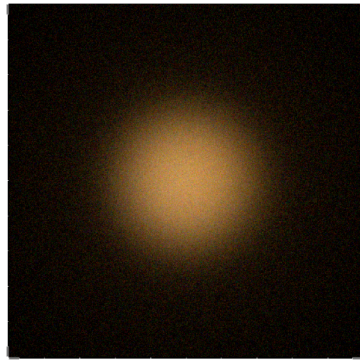

Light distribution files

### SAMSUNG

LED LC010C  
FWHM / FWTM 10.0° / 20.0°  
Efficiency 68 %  
Peak intensity 15 cd/lm  
LEDs/each optic 1  
Light colour/type White  
Required components:  
F17435\_HEKLA-G2-C

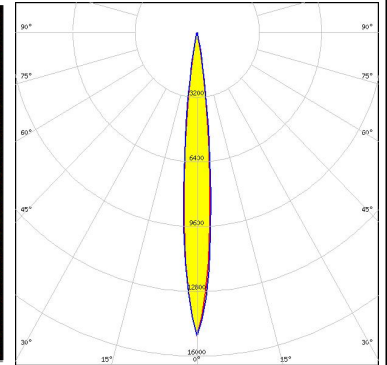

Light distribution files

### GENERAL INFORMATION:

NOTE: The typical beam angle will be changed by different color, chip size and chip position tolerance. The typical total beam angle is the full angle measured where the luminous intensity is half of the peak value.

Due to use of high power COB's with this product, special attention to proper thermal design is highly recommended. LEDiL has no liability for direct, indirect or consecutive damages arising from the LEDiL products being used outside of the recommended temperature range.

### MATERIALS:

As part of our continuous research and improvement processes, and to ensure the best possible quality and availability of our products, LEDiL reserves the right to change material grades without notice.

### PRODUCT DATA USER AGREEMENT AND DISCLAIMER:

The measured data in the provided downloadable LEDiL Product Datasheets and Mechanical 2D-Drawings is rounded and provided as reference for planning. LEDiL Oy's optical specifications have been verified by conducting performance testing of the products in accordance with the company's quality system. The reported data are averaged results of multiple measurements with typical variation. LEDiL Oy reserves the right to without prior notification make changes and improvements to its products.

LEDiL Oy assumes neither warranty, nor guarantee nor any other liability of any kind for the contents and correctness of the provided data. The provided data has been generated with highest diligence but the provided data may in reality not represent the complete possible variation range of all intrinsic parameters. Therefore, in certain cases a deviation from the provided data could occur.

LEDiL Oy reserves the right to undertake technical changes of its products without further notification which could lead to changes in the provided data. LEDiL Oy assumes no liability of any kind for the possible deviation from any provided data or any other damage resulting from the usage of the provided data.

The user agrees to this disclaimer and user agreement with the download or usage of the provided files.

#### LEDiL Oy

Joensuunkatu 13  
FI-24240 SALO  
Finland

#### LEDiL Inc.

228 West Page Street  
Suite D  
Sycamore IL 60178  
USA

#### Ledil Optics Technology (Shenzhen) Co., Ltd.

# 405 , Block B  
Casic Motor Building  
Shenzhen 518057  
P.R.CHINA

#### Local sales and technical support

[www.ledil.com/  
where\\_to\\_buy](http://www.ledil.com/where_to_buy)

#### Shipping locations

Poznan, Poland  
Hong Kong, China

#### Distribution Partners

[www.ledil.com/  
where\\_to\\_buy](http://www.ledil.com/where_to_buy)