

EMILY-SS

~11° smooth spot beam. 14.82 mm high lens.

SPECIFICATION:

Dimensions	Ø 26.0
Height	14.8 mm
Fastening	tape, pin
ROHS compliant	yes ⓘ



MATERIALS:

Component	Type	Material	Colour	Finish	Length (mm)
EMILY-SS	Single lens	PMMA	clear		
SPUTNIK-TAPE	Tape	Acryl tape	black		

ORDERING INFORMATION:

Component		Qty in box	MOQ	MPQ	Box weight (kg)
CA11387_EMILY-SS	Single lens	1690	260	130	10.4
» Box size: 480 x 280 x 300 mm					

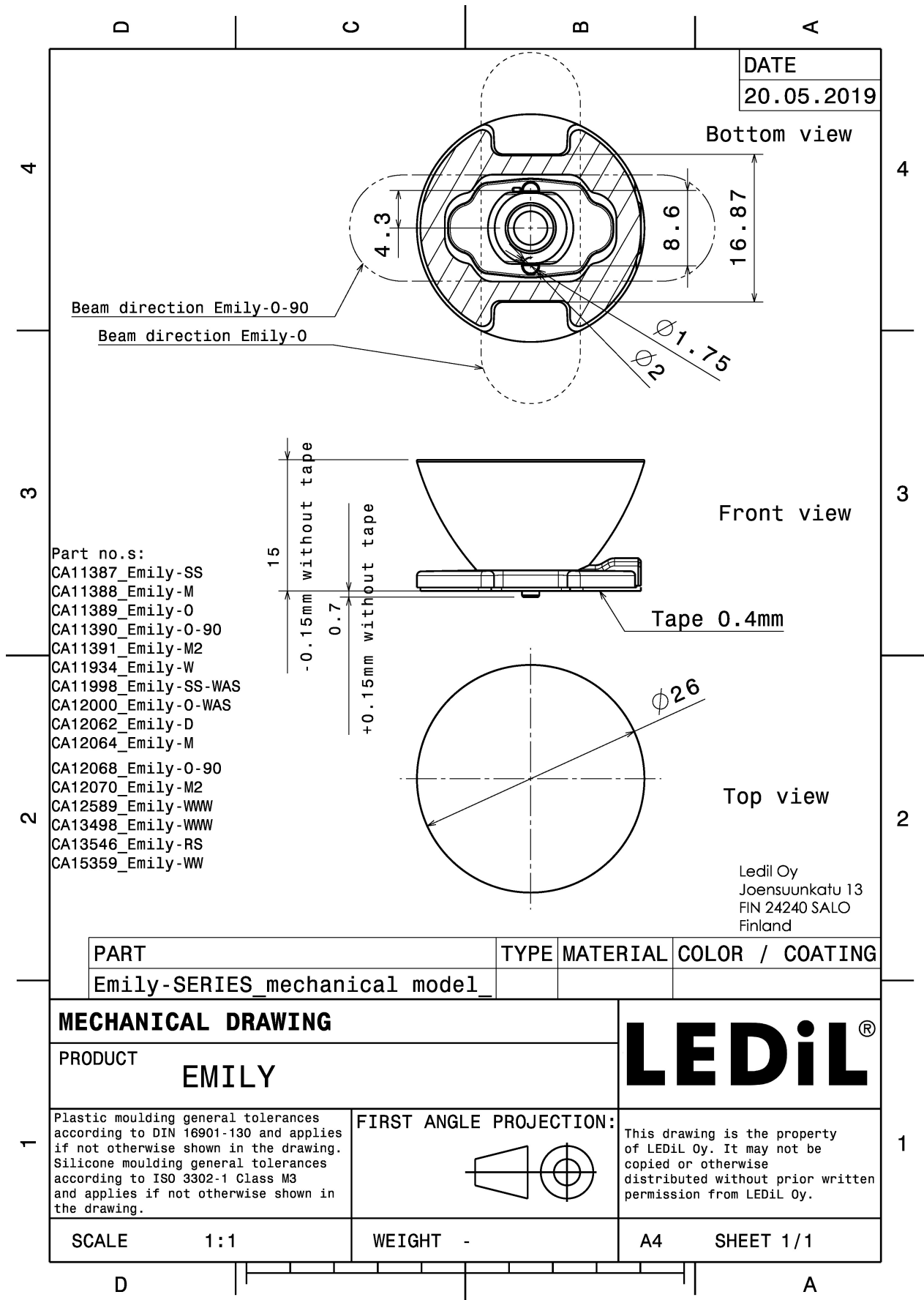

See also our general installation guide: www.ledil.com/installation_guide

OPTICAL RESULTS (MEASURED):



LED XP-E
FWHM / FWTM 10.0° / 18.0°
Efficiency 93 %
Peak intensity 17.7 cd/lm
LEDs/each optic 1
Light colour/type White
Required components:

Light distribution files



LED XP-G
FWHM / FWTM 11.0° / 21.0°
Efficiency 93 %
Peak intensity 15.5 cd/lm
LEDs/each optic 1
Light colour/type White
Required components:

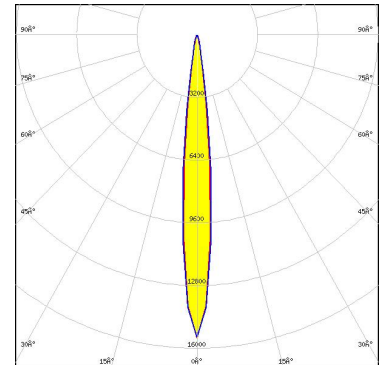

Light distribution files



LED LUXEON Rebel
FWHM / FWTM 10.0° / 20.0°
Efficiency 93 %
Peak intensity 15.9 cd/lm
LEDs/each optic 1
Light colour/type White
Required components:

Light distribution files

OPTICAL RESULTS (MEASURED):



LED NCSxx19A
FWHM / FWTM 11.0°
Efficiency 91 %
LEDs/each optic 1
Light colour/type White
Required components:

Light distribution files



LED NCSxx19B
FWHM / FWTM 12.0° / 23.0°
Efficiency 87 %
Peak intensity 15.3 cd/lm
LEDs/each optic 1
Light colour/type White
Required components:

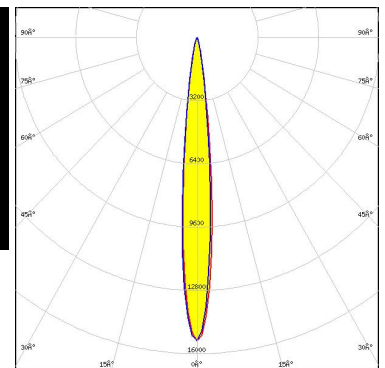

Light distribution files



LED NVSxx19A
FWHM / FWTM 13.0° / 25.0°
Efficiency 91 %
Peak intensity 11.5 cd/lm
LEDs/each optic 1
Light colour/type White
Required components:

Light distribution files

OPTICAL RESULTS (MEASURED):

OSRAM
Opto Semiconductors

LED OSLON SSL 150
FWHM / FWTM 12.0°
Efficiency %
LEDs/each optic 1
Light colour/type White
Required components:

Light distribution files

OSRAM
Opto Semiconductors

LED OSLON SSL 80
FWHM / FWTM 11.0° / 28.0°
Efficiency 88 %
Peak intensity 6.7 cd/m
LEDs/each optic 1
Light colour/type White
Required components:

Light distribution files

SEOL
SEOUL SEMICONDUCTOR

LED Z5
FWHM / FWTM 10.0°
Efficiency %
LEDs/each optic 1
Light colour/type White
Required components:

Light distribution files

OPTICAL RESULTS (MEASURED):

SHARP

LED	Double Dome (GM2BB)
FWHM / FWTM	10.0°
Efficiency	94 %
LEDs/each optic	1
Light colour/type	White
Required components:	

[Light distribution files](#)

OPTICAL RESULTS (SIMULATED):



LED XE-G
FWHM / FWTM 12.0° / 20.0°
Efficiency 96 %
Peak intensity 19 cd/lm
LEDs/each optic 1
Light colour/type White
Required components:

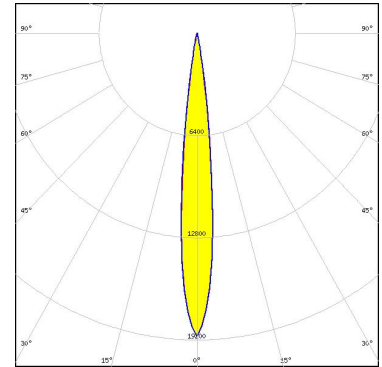

Light distribution files



LED LUXEON C
FWHM / FWTM 12.0° / 20.0°
Efficiency 91 %
Peak intensity 18.2 cd/lm
LEDs/each optic 1
Light colour/type White
Required components:

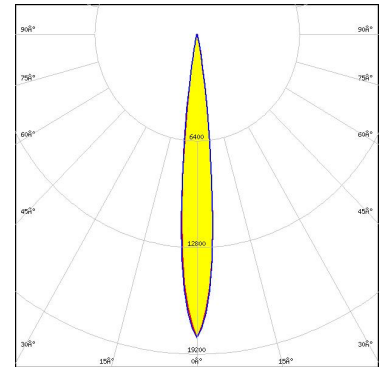

Light distribution files



LED LUXEON HL2Z
FWHM / FWTM 12.0° / 24.0°
Efficiency 95 %
Peak intensity 14.8 cd/lm
LEDs/each optic 1
Light colour/type White
Required components:

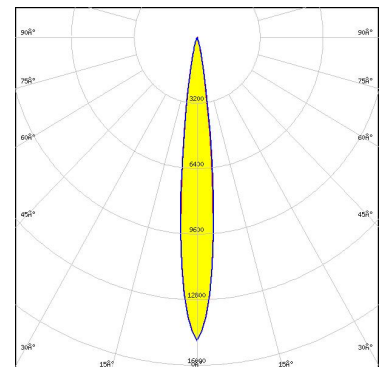

Light distribution files

OPTICAL RESULTS (SIMULATED):



LED	LUXEON SunPlus 20 Line (120 deg)
FWHM / FWTM	12.0° / 20.0°
Efficiency	95 %
Peak intensity	19.9 cd/m
LEDs/each optic	1
Light colour/type	White
Required components:	

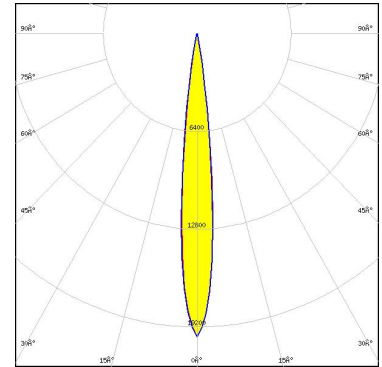

Light distribution files



LED	LUXEON Z ES
FWHM / FWTM	12.0° / 20.0°
Efficiency	96 %
Peak intensity	20.5 cd/m
LEDs/each optic	1
Light colour/type	White
Required components:	

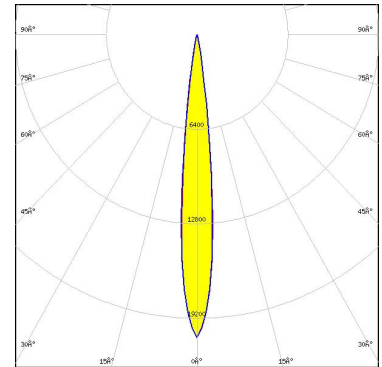

Light distribution files



LED	NCSxE17A
FWHM / FWTM	12.0° / 22.0°
Efficiency	93 %
Peak intensity	16.5 cd/m
LEDs/each optic	1
Light colour/type	White
Required components:	

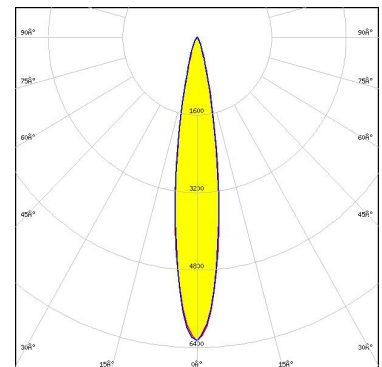

Light distribution files

OPTICAL RESULTS (SIMULATED):

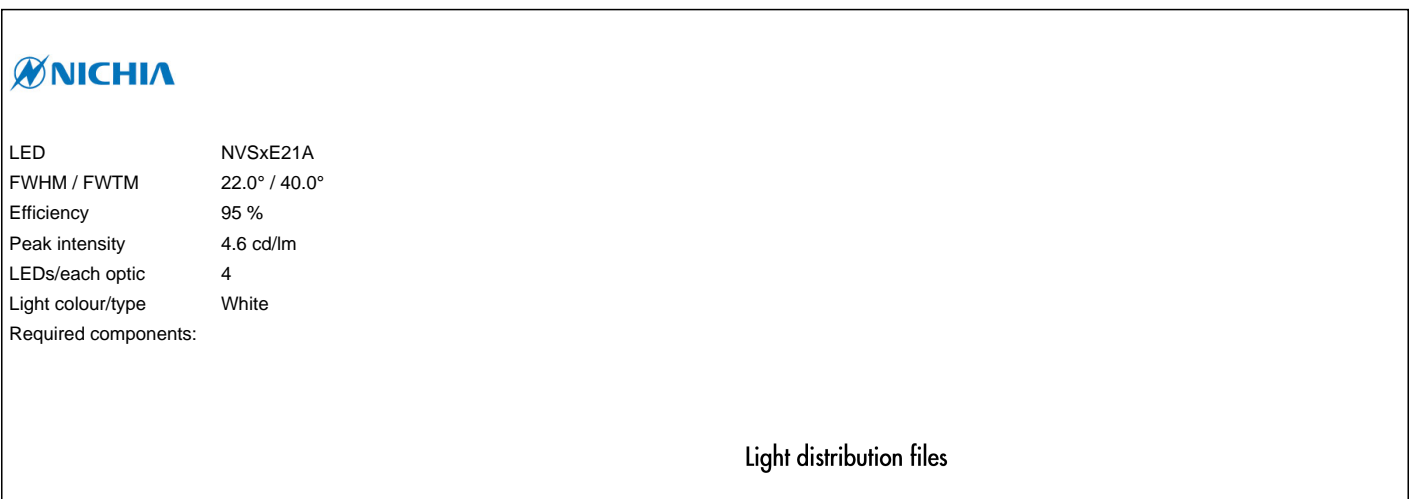
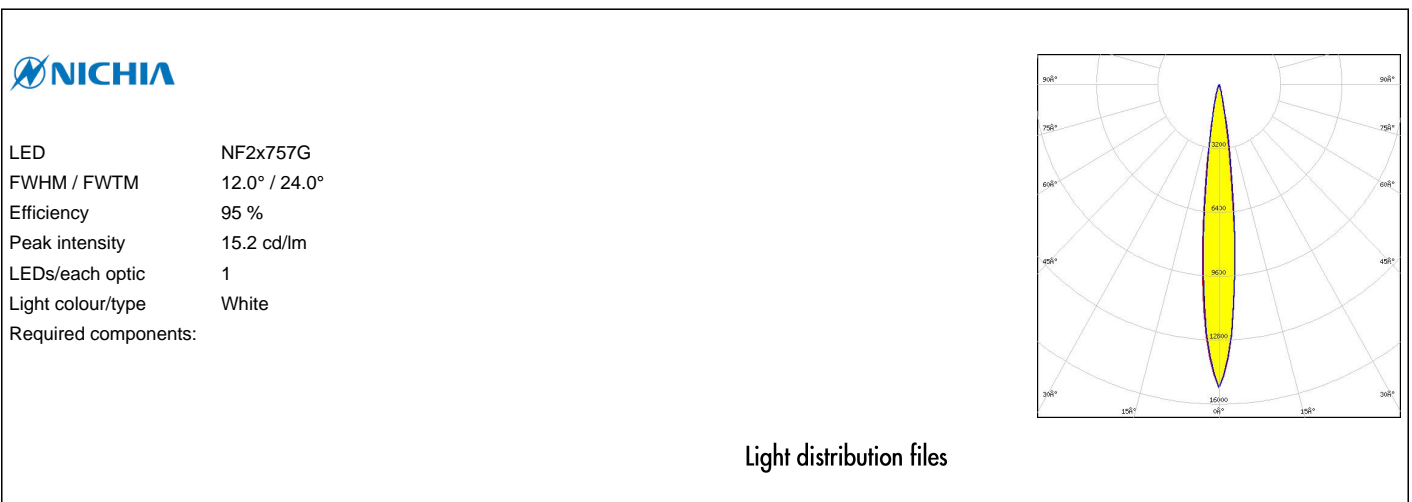
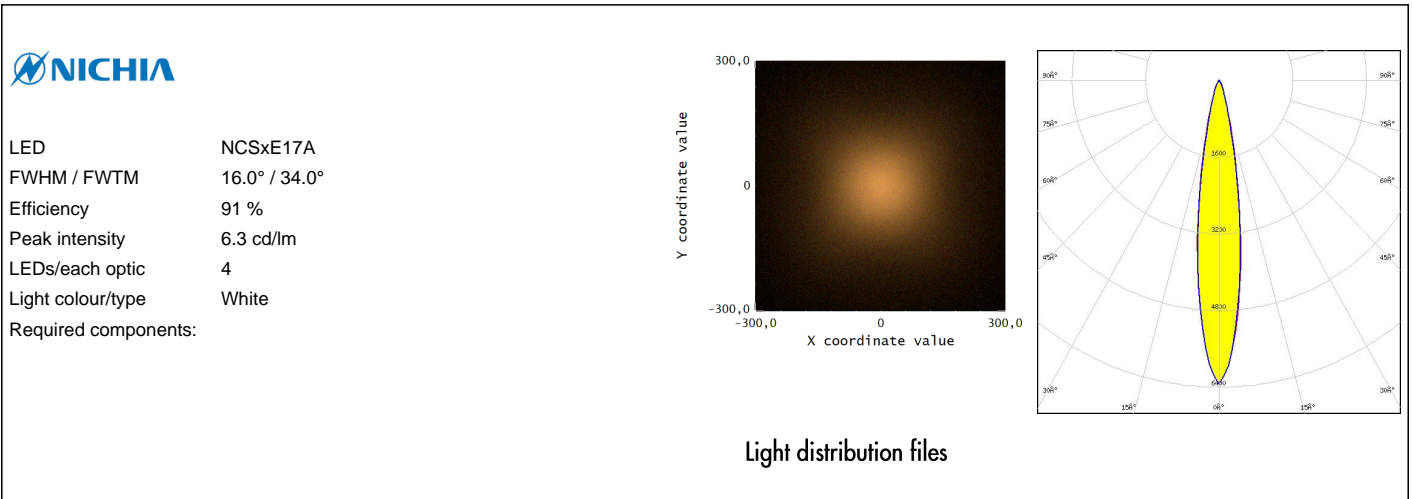

OPTICAL RESULTS (SIMULATED):

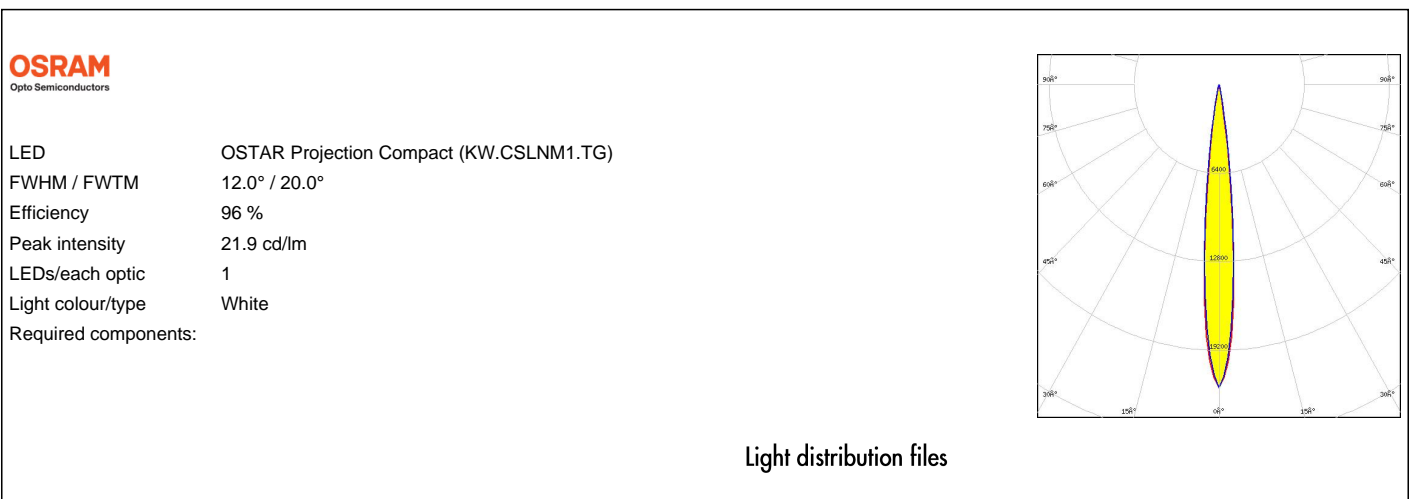
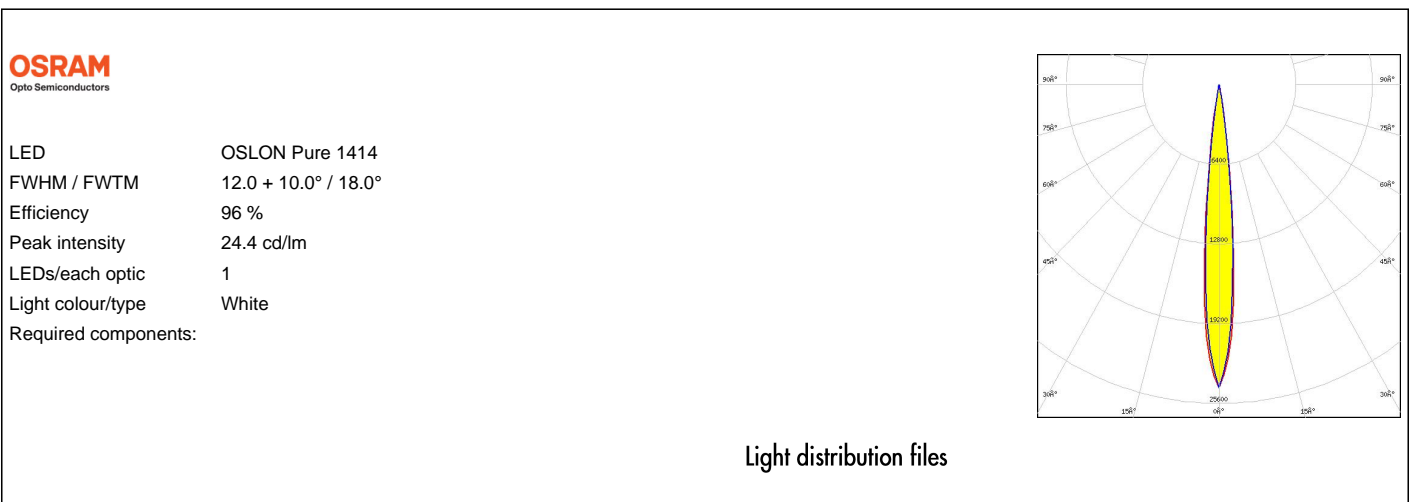
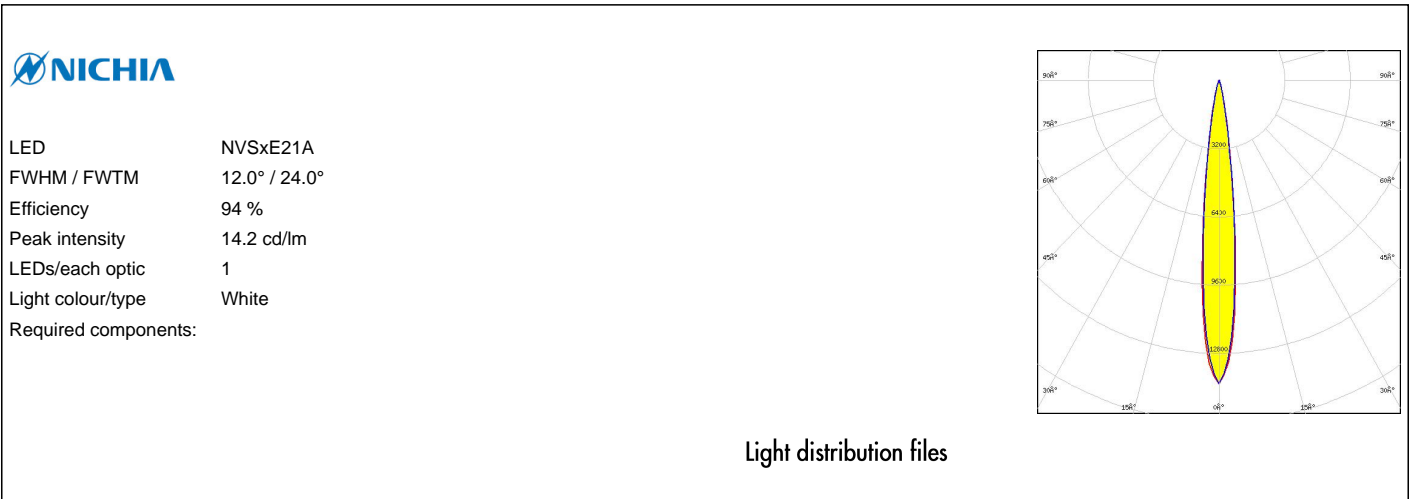

OPTICAL RESULTS (SIMULATED):

SAMSUNG

LED	LH351B
FWHM / FWTM	12.0° / 24.0°
Efficiency	94 %
Peak intensity	14.9 cd/m
LEDs/each optic	1
Light colour/type	White
Required components:	

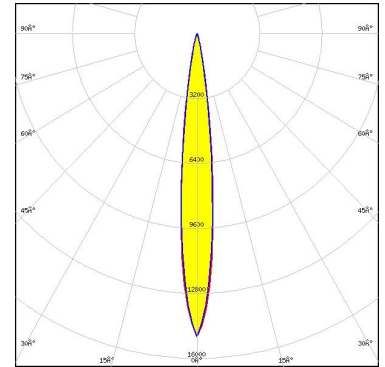

Light distribution files

GENERAL INFORMATION:

NOTE: The typical beam angle will be changed by different color, chip size and chip position tolerance. The typical total beam angle is the full angle measured where the luminous intensity is half of the peak value.

MATERIALS:

As part of our continuous research and improvement processes, and to ensure the best possible quality and availability of our products, LEDiL reserves the right to change material grades without notice.

PRODUCT DATA USER AGREEMENT AND DISCLAIMER:

The measured data in the provided downloadable LEDiL Product Datasheets and Mechanical 2D-Drawings is rounded and provided as reference for planning. LEDiL Oy's optical specifications have been verified by conducting performance testing of the products in accordance with the company's quality system. The reported data are averaged results of multiple measurements with typical variation. LEDiL Oy reserves the right to without prior notification make changes and improvements to its products.

LEDiL Oy assumes neither warranty, nor guarantee nor any other liability of any kind for the contents and correctness of the provided data. The provided data has been generated with highest diligence but the provided data may in reality not represent the complete possible variation range of all intrinsic parameters. Therefore, in certain cases a deviation from the provided data could occur.

LEDiL Oy reserves the right to undertake technical changes of its products without further notification which could lead to changes in the provided data. LEDiL Oy assumes no liability of any kind for the possible deviation from any provided data or any other damage resulting from the usage of the provided data.

The user agrees to this disclaimer and user agreement with the download or usage of the provided files.

LEDiL Oy

Joensuunkatu 7
FI-24100 SALO
Finland

LEDiL Inc.

228 West Page Street
Suite D
Sycamore IL 60178
USA

Ledil Optics Technology (Shenzhen) Co., Ltd.

405 , Block B
Casic Motor Building
Shenzhen 518057
P.R.CHINA

Local sales and technical support

[www.ledil.com/
where_to_buy](http://www.ledil.com/where_to_buy)

Shipping locations

Poznan, Poland
Hong Kong, China

Distribution Partners

[www.ledil.com/
where_to_buy](http://www.ledil.com/where_to_buy)