

EMILY-M

~20° medium beam. 14.85 mm high lens.

SPECIFICATION:

Dimensions	Ø 26.0
Height	14.9 mm
Fastening	tape, pin
ROHS compliant	yes ⓘ



MATERIALS:

Component	Type	Material	Colour	Finish	Length (mm)
EMILY-M	Single lens	PMMA	clear		
SPUTNIK-TAPE	Tape	Acryl tape	black		

ORDERING INFORMATION:

Component		Qty in box	MOQ	MPQ	Box weight (kg)
CA12064_EMILY-M	Single lens	1690	260	130	10.7
» Box size: 480 x 280 x 300 mm					

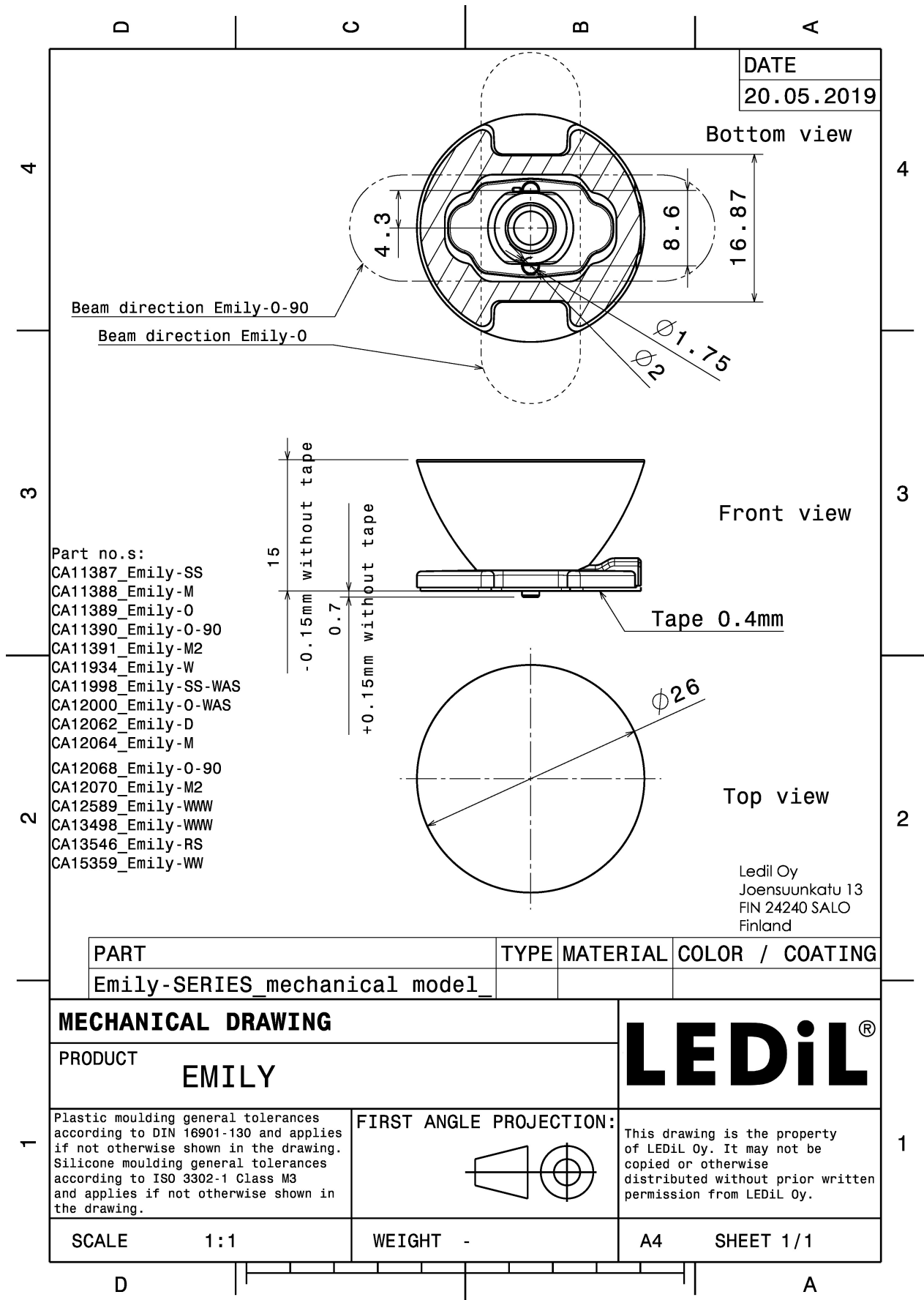

See also our general installation guide: www.ledil.com/installation_guide

OPTICAL RESULTS (MEASURED):



LED XM-L
 FWHM / FWTM 18.0°
 Efficiency 93 %
 LEDs/each optic 1
 Light colour/type White
 Required components:

Light distribution files



LED XM-L2
 FWHM / FWTM 18.0° / 33.0°
 Efficiency 90 %
 Peak intensity 7.9 cd/lm
 LEDs/each optic 1
 Light colour/type White
 Required components:

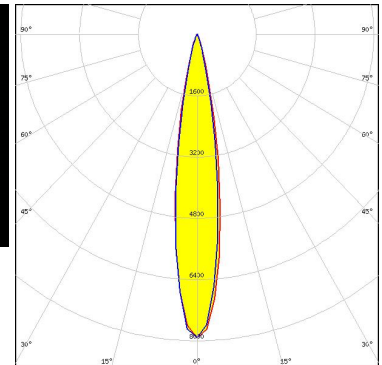

Light distribution files



LED XP-E2
 FWHM / FWTM 17.0° / 27.0°
 Efficiency 87 %
 Peak intensity 9.2 cd/lm
 LEDs/each optic 1
 Light colour/type White
 Required components:

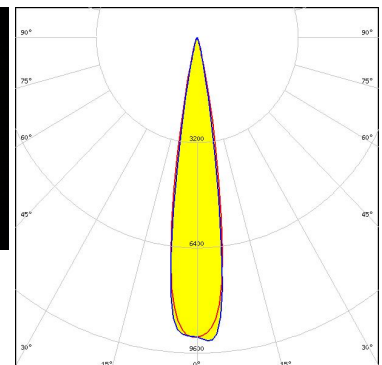

Light distribution files

OPTICAL RESULTS (MEASURED):



LED XP-G2
 FWHM / FWTM 18.0° / 29.0°
 Efficiency 90 %
 Peak intensity 10.1 cd/lm
 LEDs/each optic 1
 Light colour/type White
 Required components:

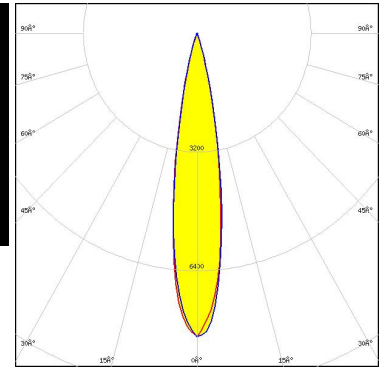
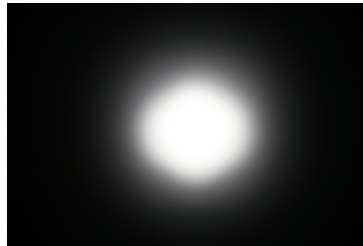

Light distribution files



LED XP-G3
 FWHM / FWTM 17.0° / 30.0°
 Efficiency 94 %
 Peak intensity 8 cd/lm
 LEDs/each optic 1
 Light colour/type White
 Required components:

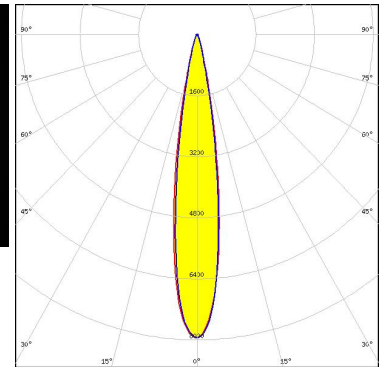

Light distribution files



LED XP-L HI
 FWHM / FWTM 17.0° / 27.0°
 Efficiency 88 %
 Peak intensity 9 cd/lm
 LEDs/each optic 1
 Light colour/type White
 Required components:

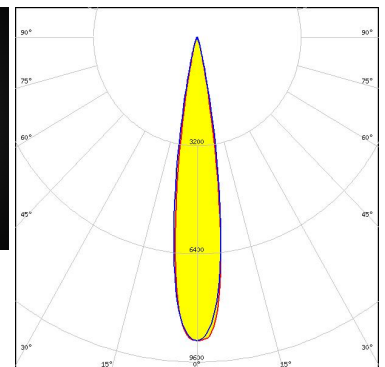
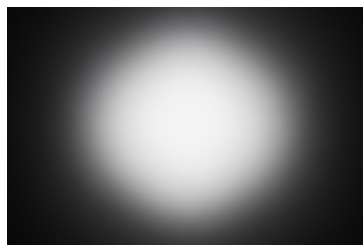

Light distribution files

OPTICAL RESULTS (MEASURED):



LED XT-E
FWHM / FWTM 17.0°
Efficiency %
Peak intensity 6.9 cd/m
LEDs/each optic 1
Light colour/type White
Required components:

Light distribution files



LED LUXEON A
FWHM / FWTM 18.0°
Efficiency 90 %
LEDs/each optic 1
Light colour/type White
Required components:

Light distribution files



LED LUXEON Rebel ES
FWHM / FWTM 18.0°
Efficiency 90 %
LEDs/each optic 1
Light colour/type White
Required components:

Light distribution files

OPTICAL RESULTS (MEASURED):



LED NS9x383
FWHM / FWTM 18.0° / 35.0°
Efficiency 90 %
Peak intensity 6.1 cd/lm
LEDs/each optic 1
Light colour/type White
Required components:

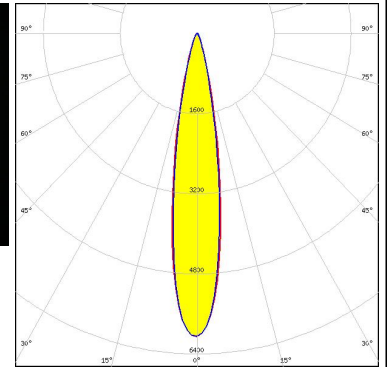

Light distribution files



LED LH351B
FWHM / FWTM 17.0° / 30.0°
Efficiency 88 %
Peak intensity 8.7 cd/lm
LEDs/each optic 1
Light colour/type White
Required components:

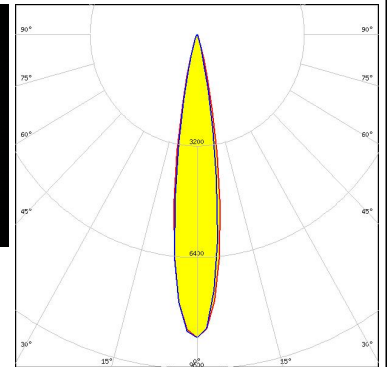

Light distribution files



LED LH351Z
FWHM / FWTM 18.0° / 29.0°
Efficiency 89 %
Peak intensity 9.4 cd/lm
LEDs/each optic 1
Light colour/type White
Required components:

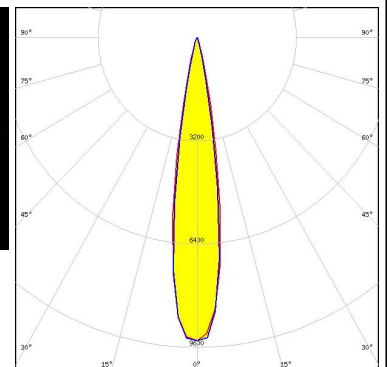

Light distribution files

OPTICAL RESULTS (MEASURED):

 SEOL SEMICONDUCTOR		
LED	Z8Y22P	
FWHM / FWTM	17.0° / 32.0°	
Efficiency	94 %	
Peak intensity	7 cd/lm	
LEDs/each optic	1	
Light colour/type	White	
Required components:		

Light distribution files

OPTICAL RESULTS (SIMULATED):



LED XM-L HVW
FWHM / FWTM 19.0°
Efficiency %
LEDs/each optic 1
Light colour/type White
Required components:

Light distribution files



LED XP-G2 HE
FWHM / FWTM 18.0° / 33.0°
Efficiency 94 %
Peak intensity 7.3 cd/lm
LEDs/each optic 1
Light colour/type White
Required components:

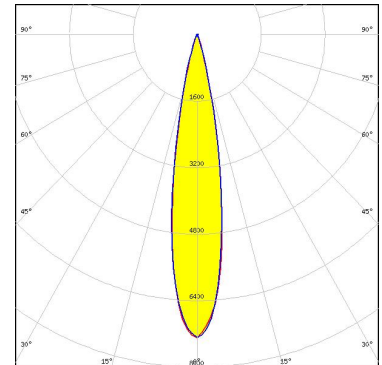

Light distribution files



LED XP-L2
FWHM / FWTM 20.0° / 36.0°
Efficiency 94 %
Peak intensity 6.3 cd/lm
LEDs/each optic 1
Light colour/type White
Required components:

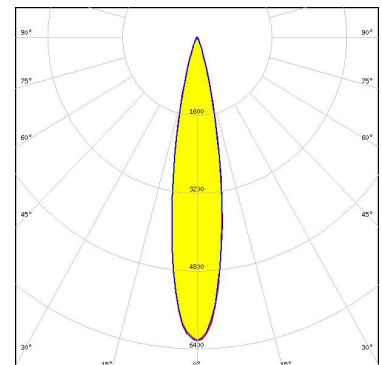

Light distribution files

OPTICAL RESULTS (SIMULATED):



LED LUXEON MZ
FWHM / FWTM 19.0° / 36.0°
Efficiency 96 %
Peak intensity 6.5 cd/lm
LEDs/each optic 1
Light colour/type White
Required components:

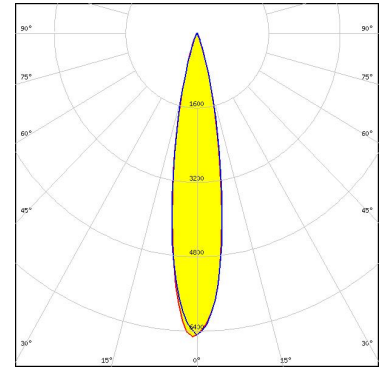

Light distribution files



LED NVSxE21A
FWHM / FWTM 22.0° / 44.0°
Efficiency 94 %
Peak intensity 4.2 cd/lm
LEDs/each optic 4
Light colour/type White
Required components:

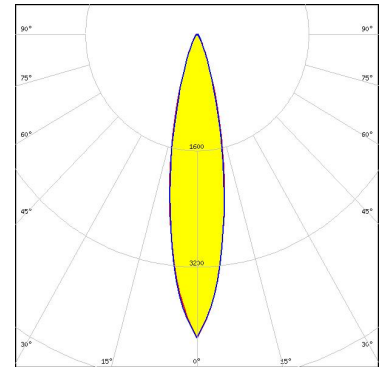

Light distribution files



LED OSOLON Black
FWHM / FWTM 15.0° / 27.0°
Efficiency 94 %
Peak intensity 10.9 cd/lm
LEDs/each optic 1
Light colour/type White
Required components:

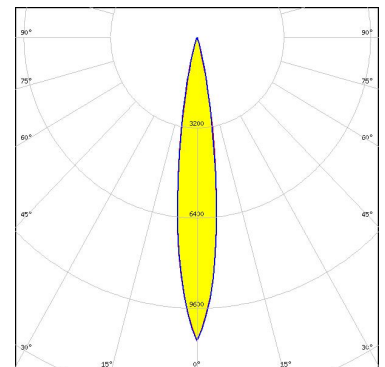

Light distribution files

OPTICAL RESULTS (SIMULATED):

OSRAM
Opto Semiconductors

LED OSLON Black Flat (LUW HWQP)
 FWHM / FWTM 17.0° / 28.0°
 Efficiency 94 %
 Peak intensity 10 cd/lm
 LEDs/each optic 1
 Light colour/type White
 Required components:

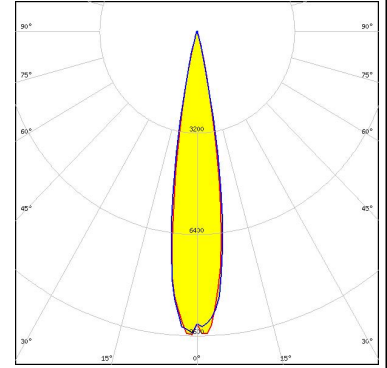

Light distribution files

OSRAM
Opto Semiconductors

LED SFH 4725AS
 FWHM / FWTM 18.0° / 32.0°
 Efficiency 94 %
 LEDs/each optic 1
 Light colour/type IR
 Required components:

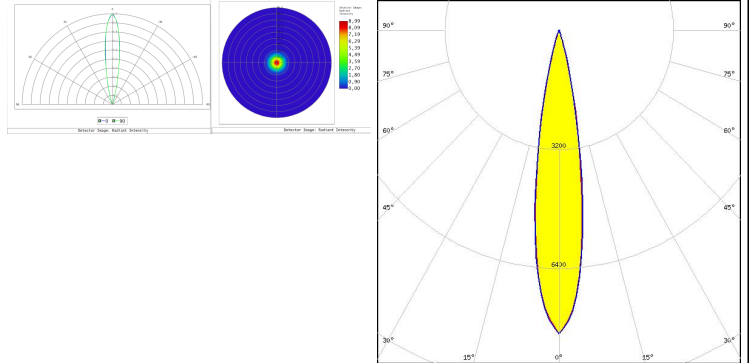

Light distribution files

GENERAL INFORMATION:

NOTE: The typical beam angle will be changed by different color, chip size and chip position tolerance. The typical total beam angle is the full angle measured where the luminous intensity is half of the peak value.

MATERIALS:

As part of our continuous research and improvement processes, and to ensure the best possible quality and availability of our products, LEDiL reserves the right to change material grades without notice.

PRODUCT DATA USER AGREEMENT AND DISCLAIMER:

The measured data in the provided downloadable LEDiL Product Datasheets and Mechanical 2D-Drawings is rounded and provided as reference for planning. LEDiL Oy's optical specifications have been verified by conducting performance testing of the products in accordance with the company's quality system. The reported data are averaged results of multiple measurements with typical variation. LEDiL Oy reserves the right to without prior notification make changes and improvements to its products.

LEDiL Oy assumes neither warranty, nor guarantee nor any other liability of any kind for the contents and correctness of the provided data. The provided data has been generated with highest diligence but the provided data may in reality not represent the complete possible variation range of all intrinsic parameters. Therefore, in certain cases a deviation from the provided data could occur.

LEDiL Oy reserves the right to undertake technical changes of its products without further notification which could lead to changes in the provided data. LEDiL Oy assumes no liability of any kind for the possible deviation from any provided data or any other damage resulting from the usage of the provided data.

The user agrees to this disclaimer and user agreement with the download or usage of the provided files.

LEDiL Oy

Joensuunkatu 7
FI-24100 SALO
Finland

LEDiL Inc.

228 West Page Street
Suite D
Sycamore IL 60178
USA

Ledil Optics Technology (Shenzhen) Co., Ltd.

405 , Block B
Casic Motor Building
Shenzhen 518057
P.R.CHINA

Local sales and technical support

[www.ledil.com/
where_to_buy](http://www.ledil.com/where_to_buy)

Shipping locations

Poznan, Poland
Hong Kong, China

Distribution Partners

[www.ledil.com/
where_to_buy](http://www.ledil.com/where_to_buy)