

EMILY-RS

~8° spot beam. 14.74 mm high lens.

SPECIFICATION:

| | |
|----------------|---------|
| Dimensions | Ø 26.0 |
| Height | 14.7 mm |
| Fastening | tape |
| ROHS compliant | yes ⓘ |

MATERIALS:

| Component | Type | Material | Colour | Finish | Length (mm) |
|--------------|-------------|------------|--------|--------|-------------|
| EMILY-RS | Single lens | PMMA | clear | | |
| SPUTNIK-TAPE | Tape | Acryl tape | black | | |



ORDERING INFORMATION:

| Component | | Qty in box | MOQ | MPQ | Box weight (kg) |
|--------------------------------|-------------|------------|-----|-----|-----------------|
| CA13546_EMILY-RS | Single lens | 1690 | 260 | 130 | 10.3 |
| » Box size: 480 x 280 x 300 mm | | | | | |

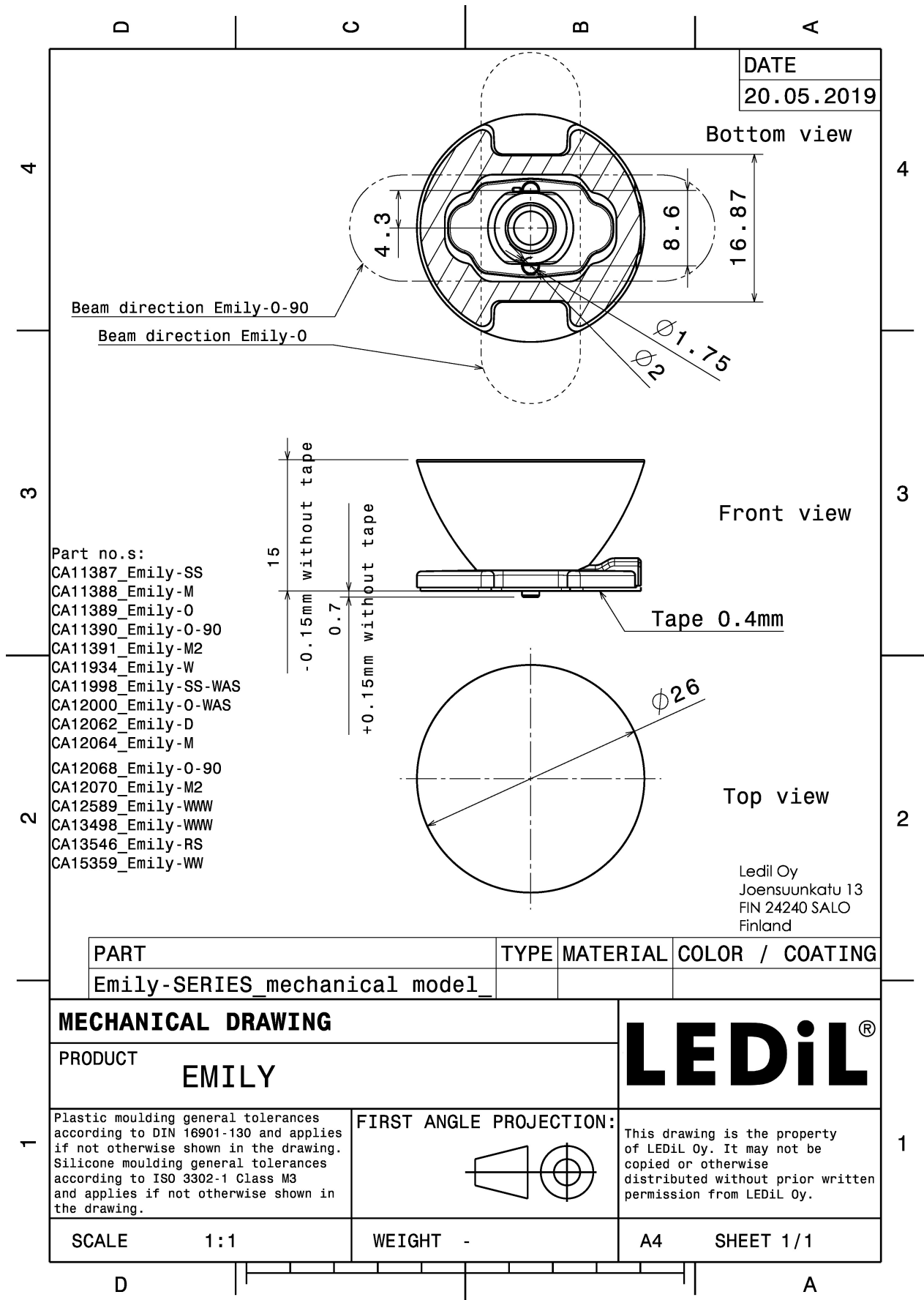

See also our general installation guide: www.ledil.com/installation_guide

OPTICAL RESULTS (MEASURED):



LED XB-H
FWHM / FWTM 9.0° / 17.0°
Efficiency 88 %
Peak intensity 24.7 cd/lm
LEDs/each optic 1
Light colour/type White
Required components:

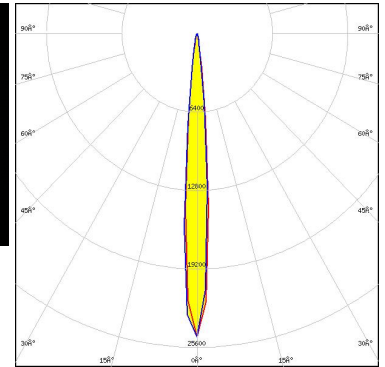

Light distribution files



LED XP-E2
FWHM / FWTM 6.0° / 11.0°
Efficiency 96 %
Peak intensity 57.6 cd/lm
LEDs/each optic 1
Light colour/type White
Required components:

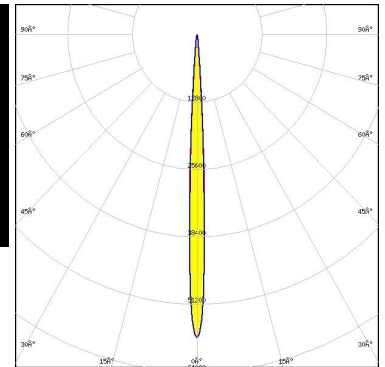
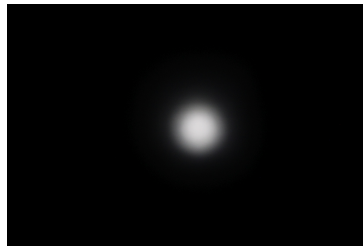

Light distribution files



LED XP-G3
FWHM / FWTM 10.0° / 18.0°
Efficiency 94 %
Peak intensity 18 cd/lm
LEDs/each optic 1
Light colour/type White
Required components:

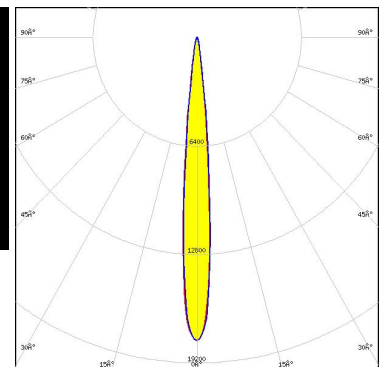

Light distribution files

OPTICAL RESULTS (MEASURED):



LED XP-L HD
 FWHM / FWTM 13.0° / 23.0°
 Efficiency 89 %
 Peak intensity 13.1 cd/lm
 LEDs/each optic 1
 Light colour/type White
 Required components:

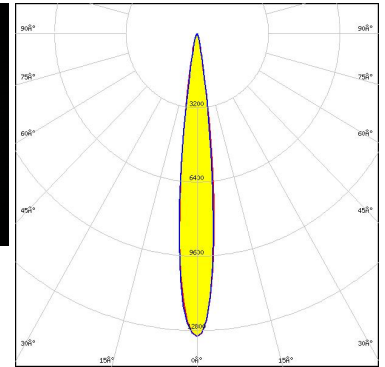
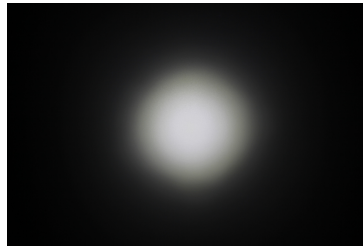

Light distribution files



LED XP-L HI
 FWHM / FWTM 8.0° / 15.0°
 Efficiency 88 %
 Peak intensity 28 cd/lm
 LEDs/each optic 1
 Light colour/type White
 Required components:

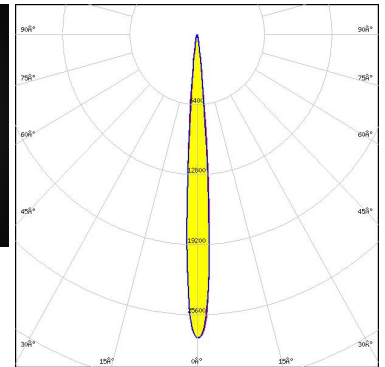

Light distribution files



LED XP-L2
 FWHM / FWTM 13.0° / 25.0°
 Efficiency 93 %
 Peak intensity 10 cd/lm
 LEDs/each optic 1
 Light colour/type White
 Required components:

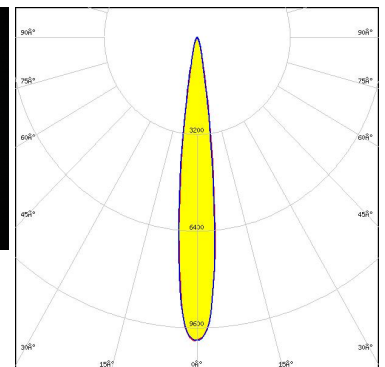

Light distribution files

OPTICAL RESULTS (MEASURED):



LED XQ-E HI
 FWHM / FWTM 4.0° / 9.0°
 Efficiency 94 %
 Peak intensity 71.1 cd/lm
 LEDs/each optic 1
 Light colour/type White
 Required components:

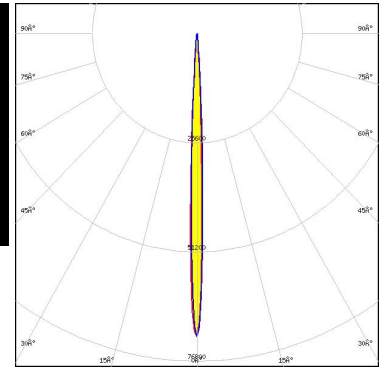

Light distribution files



LED XT-E
 FWHM / FWTM 8.0° / 16.0°
 Efficiency 91 %
 Peak intensity 23.9 cd/lm
 LEDs/each optic 1
 Light colour/type White
 Required components:

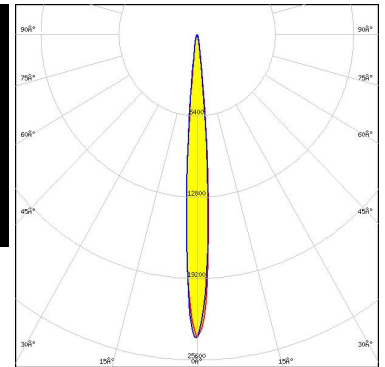
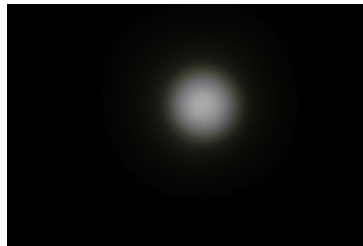

Light distribution files



LED LUXEON Z ES
 FWHM / FWTM 5.0° / 11.0°
 Efficiency 91 %
 Peak intensity 52 cd/lm
 LEDs/each optic 1
 Light colour/type White
 Required components:

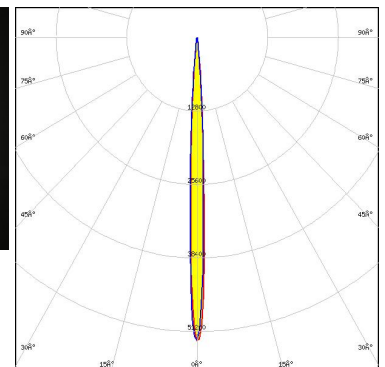

Light distribution files

OPTICAL RESULTS (MEASURED):

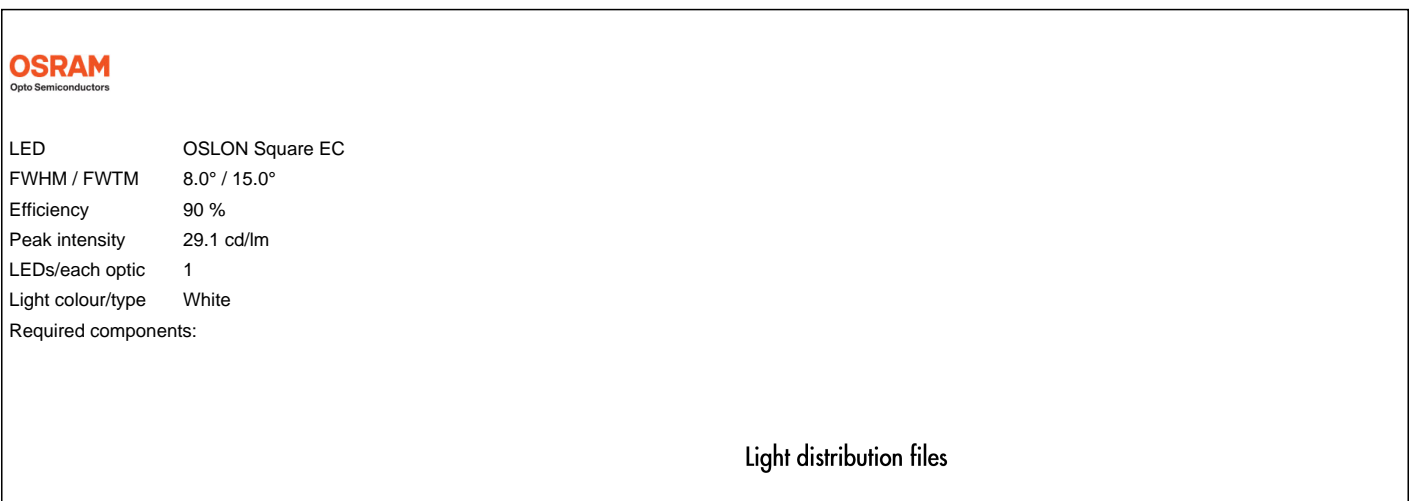
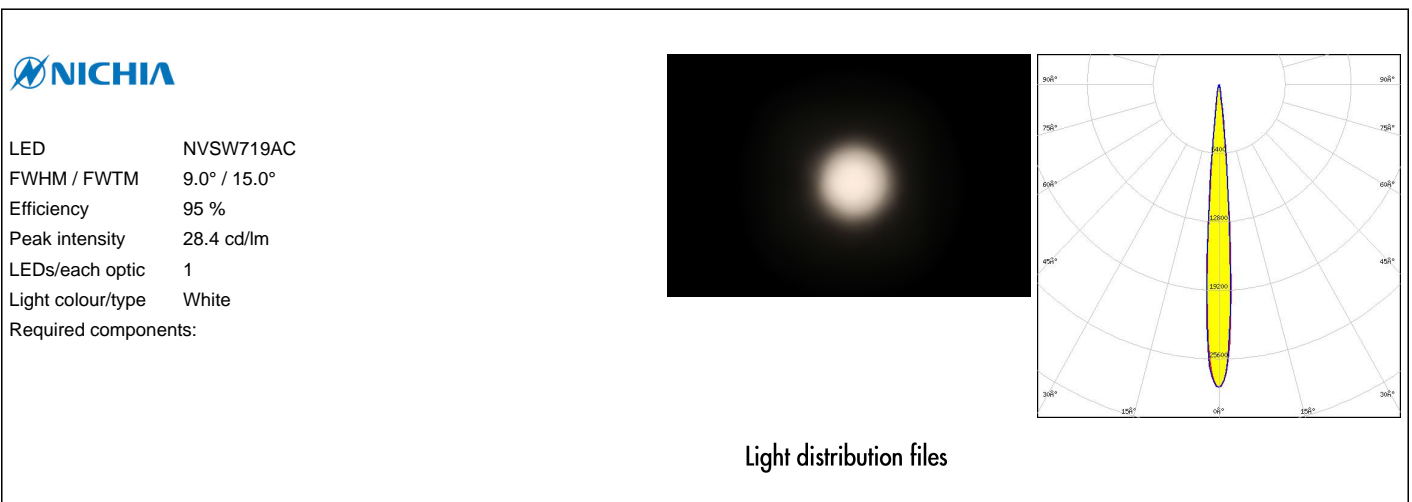
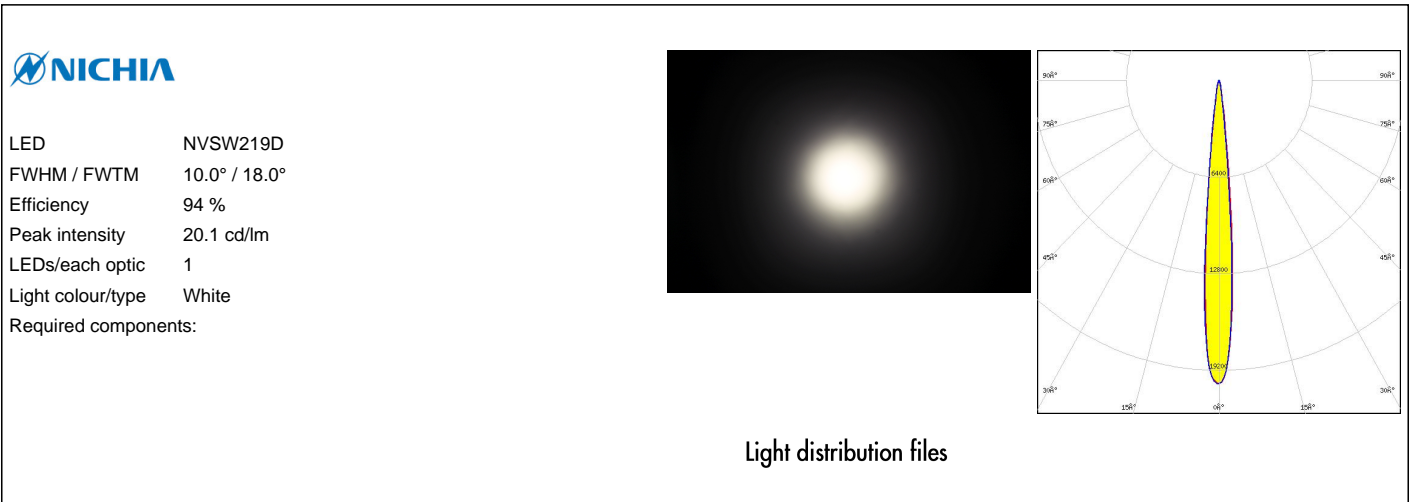

OPTICAL RESULTS (MEASURED):

OSRAM
Opto Semiconductors

LED PLPVEC2 850A
FWHM / FWTM 4.0° / 11.0°
Efficiency %
LEDs/each optic 1
Light colour/type IR
Required components:

Light distribution files

SEOL
SEOUL SEMICONDUCTOR

LED nPola
FWHM / FWTM 5.0°
Efficiency 94 %
Peak intensity 81.2 cd/lm
LEDs/each optic 1
Light colour/type White
Required components:

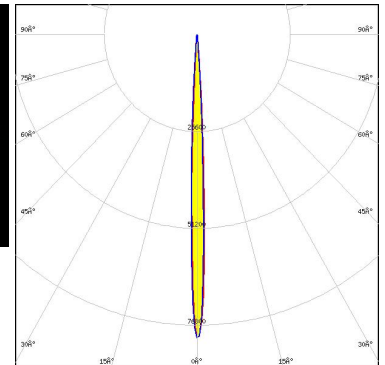

Light distribution files

SEOL
SEOUL SEMICONDUCTOR

LED Z5M1/Z5M2
FWHM / FWTM 9.0° / 15.0°
Efficiency 91 %
Peak intensity 23.7 cd/lm
LEDs/each optic 1
Light colour/type White
Required components:

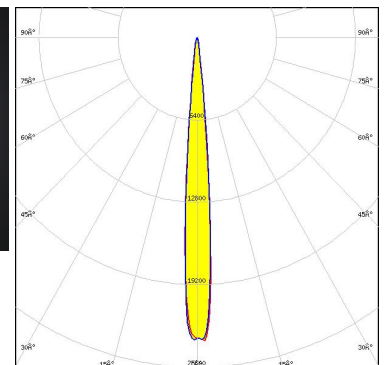
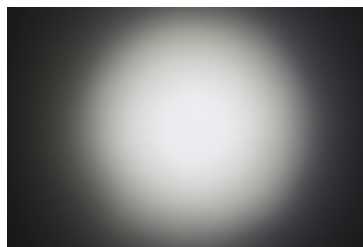

Light distribution files

OPTICAL RESULTS (SIMULATED):



LED XE-G
FWHM / FWTM 8.0° / 14.0°
Efficiency 95 %
Peak intensity 41.3 cd/lm
LEDs/each optic 1
Light colour/type Red
Required components:

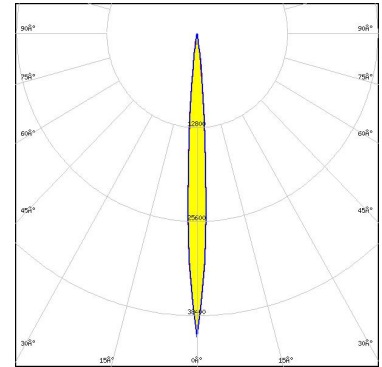

Light distribution files



LED XHP35 HI
FWHM / FWTM 10.0° / 18.0°
Efficiency 96 %
Peak intensity 22 cd/lm
LEDs/each optic 1
Light colour/type White
Required components:

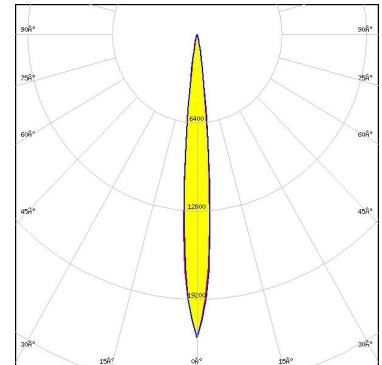

Light distribution files



LED XP-E2
FWHM / FWTM 6.0° / 14.0°
Efficiency 94 %
Peak intensity 51.8 cd/lm
LEDs/each optic 1
Light colour/type White
Required components:

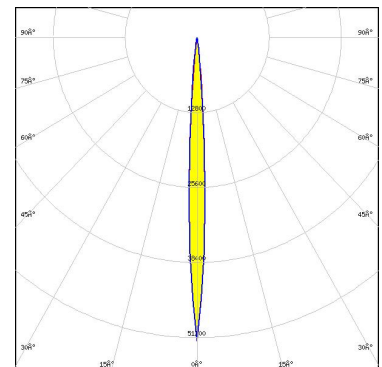

Light distribution files

OPTICAL RESULTS (SIMULATED):



LED XP-G2
 FWHM / FWTM 8.0° / 16.0°
 Efficiency 94 %
 Peak intensity 30.4 cd/lm
 LEDs/each optic 1
 Light colour/type White
 Required components:

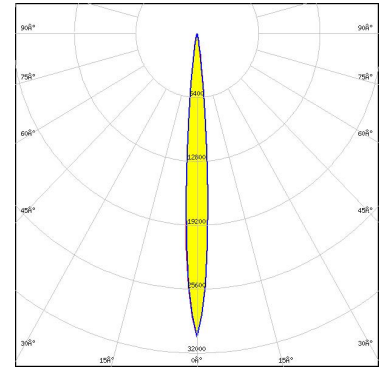

Light distribution files



LED XP-G2 HE
 FWHM / FWTM 10.0° / 20.0°
 Efficiency 95 %
 Peak intensity 19.1 cd/lm
 LEDs/each optic 1
 Light colour/type White
 Required components:

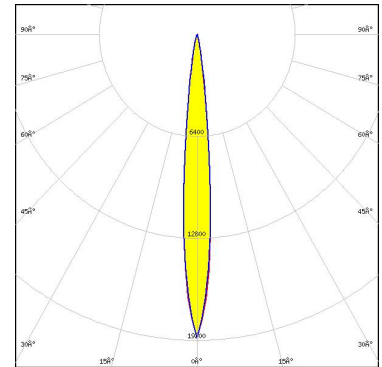

Light distribution files



LED XP-GR
 FWHM / FWTM 6.0° / 12.0°
 Efficiency 96 %
 Peak intensity 67.1 cd/lm
 LEDs/each optic 1
 Light colour/type White
 Required components:

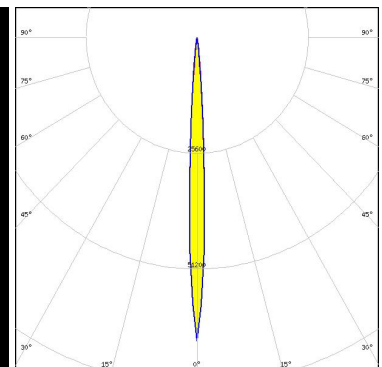
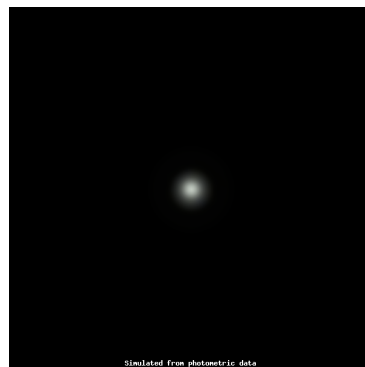

Light distribution files

OPTICAL RESULTS (SIMULATED):



LED XP-LR
 FWHM / FWTM 6.0° / 14.0°
 Efficiency 96 %
 Peak intensity 51.3 cd/lm
 LEDs/each optic 1
 Light colour/type White
 Required components:

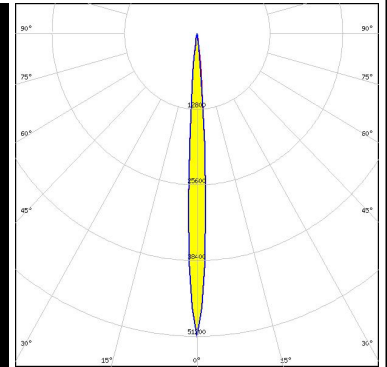

Light distribution files



LED XP-P
 FWHM / FWTM 6.0° / 12.0°
 Efficiency 96 %
 Peak intensity 63.8 cd/lm
 LEDs/each optic 1
 Light colour/type White
 Required components:

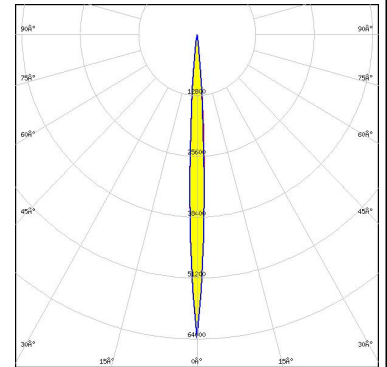

Light distribution files



LED LUXEON C
 FWHM / FWTM 7.0° / 16.0°
 Efficiency 94 %
 Peak intensity 37.3 cd/lm
 LEDs/each optic 1
 Light colour/type Royal Blue
 Required components:

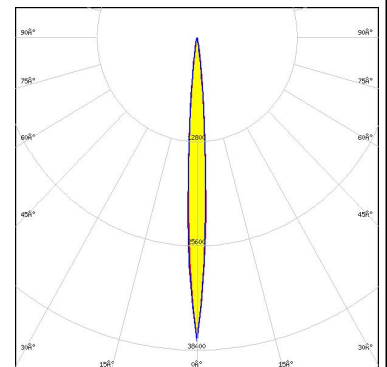

Light distribution files

OPTICAL RESULTS (SIMULATED):



LED LUXEON HL2Z
FWHM / FWTM 8.0° / 18.0°
Efficiency 96 %
Peak intensity 27.7 cd/lm
LEDs/each optic 1
Light colour/type White
Required components:

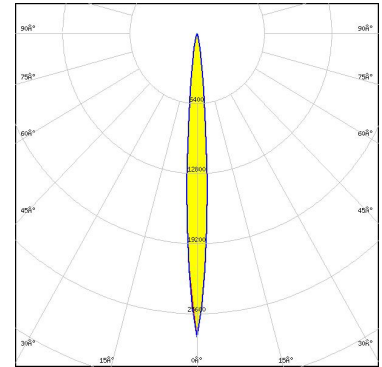

Light distribution files



LED LUXEON MZ
FWHM / FWTM 14.0° / 26.0°
Efficiency 95 %
Peak intensity 10.7 cd/lm
LEDs/each optic 1
Light colour/type White
Required components:

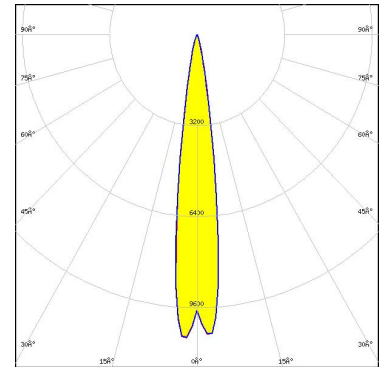

Light distribution files



LED LUXEON Rebel
FWHM / FWTM 6.0° / 14.0°
Efficiency 94 %
Peak intensity 41.5 cd/lm
LEDs/each optic 1
Light colour/type White
Required components:

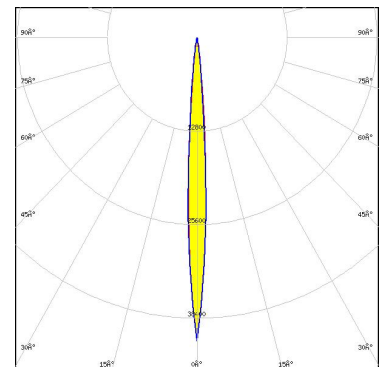

Light distribution files

OPTICAL RESULTS (SIMULATED):



LED LUXEON Rebel Plus
FWHM / FWTM 6.0° / 14.0°
Efficiency 94 %
Peak intensity 42.1 cd/lm
LEDs/each optic 1
Light colour/type White
Required components:

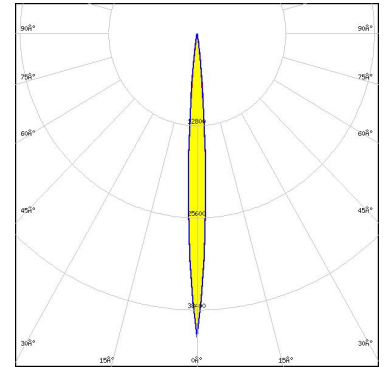

Light distribution files



LED LUXEON Rubix
FWHM / FWTM 6.0° / 12.0°
Efficiency 96 %
Peak intensity 63.9 cd/lm
LEDs/each optic 1
Light colour/type Blue
Required components:

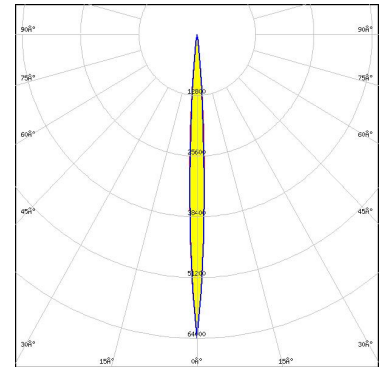

Light distribution files



LED LUXEON Rubix
FWHM / FWTM 6.0° / 12.0°
Efficiency 96 %
Peak intensity 67.4 cd/lm
LEDs/each optic 1
Light colour/type Red
Required components:

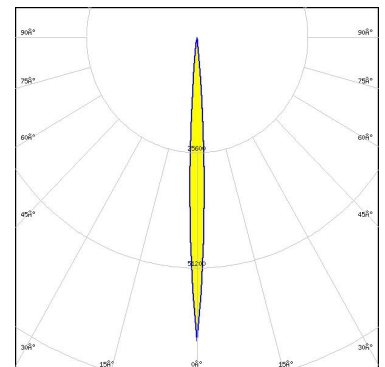

Light distribution files

OPTICAL RESULTS (SIMULATED):



LED LUXEON Rubix
 FWHM / FWTM 6.0° / 12.0°
 Efficiency 96 %
 Peak intensity 64.5 cd/lm
 LEDs/each optic 1
 Light colour/type Green
 Required components:

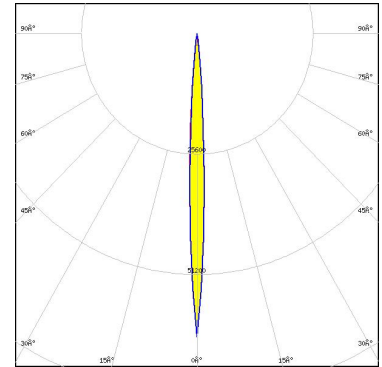

Light distribution files



LED LUXEON Rubix
 FWHM / FWTM 6.0° / 12.0°
 Efficiency 96 %
 Peak intensity 62.6 cd/lm
 LEDs/each optic 1
 Light colour/type White
 Required components:

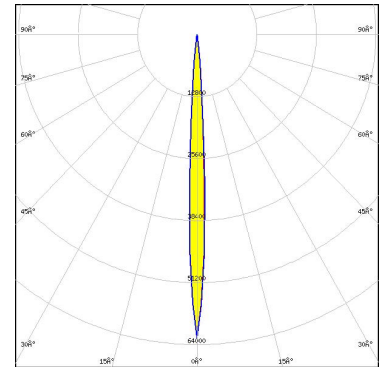

Light distribution files



LED LUXEON SunPlus 20 Line (120 deg)
 FWHM / FWTM 6.0° / 13.0°
 Efficiency 96 %
 Peak intensity 50.8 cd/lm
 LEDs/each optic 1
 Light colour/type White
 Required components:

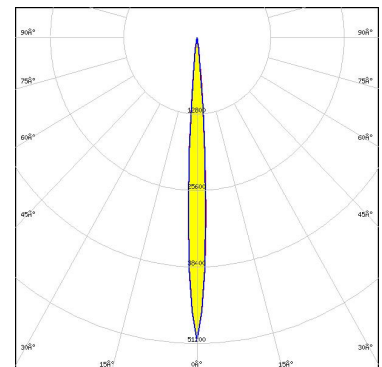

Light distribution files

OPTICAL RESULTS (SIMULATED):



LED LUXEON Z
 FWHM / FWTM 5.9° / 12.0°
 Efficiency 94 %
 Peak intensity 65.3 cd/lm
 LEDs/each optic 1
 Light colour/type White
 Required components:

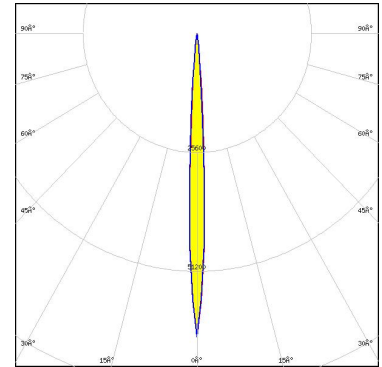

Light distribution files



LED NCSxE17A
 FWHM / FWTM 6.0° / 16.0°
 Efficiency 93 %
 Peak intensity 35.5 cd/lm
 LEDs/each optic 1
 Light colour/type White
 Required components:

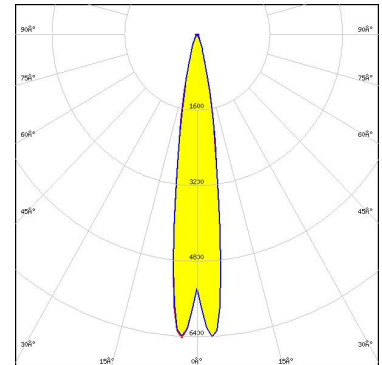

Light distribution files



LED NCSxE17A
 FWHM / FWTM 8.0° / 16.0°
 Efficiency 92 %
 Peak intensity 32.5 cd/lm
 LEDs/each optic 1
 Light colour/type White
 Required components:

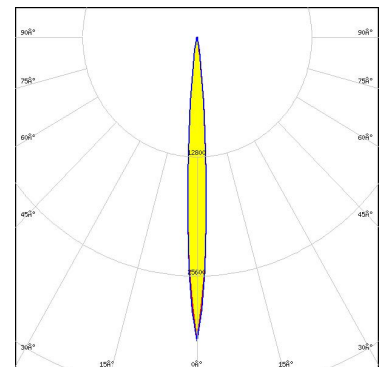

Light distribution files

OPTICAL RESULTS (SIMULATED):

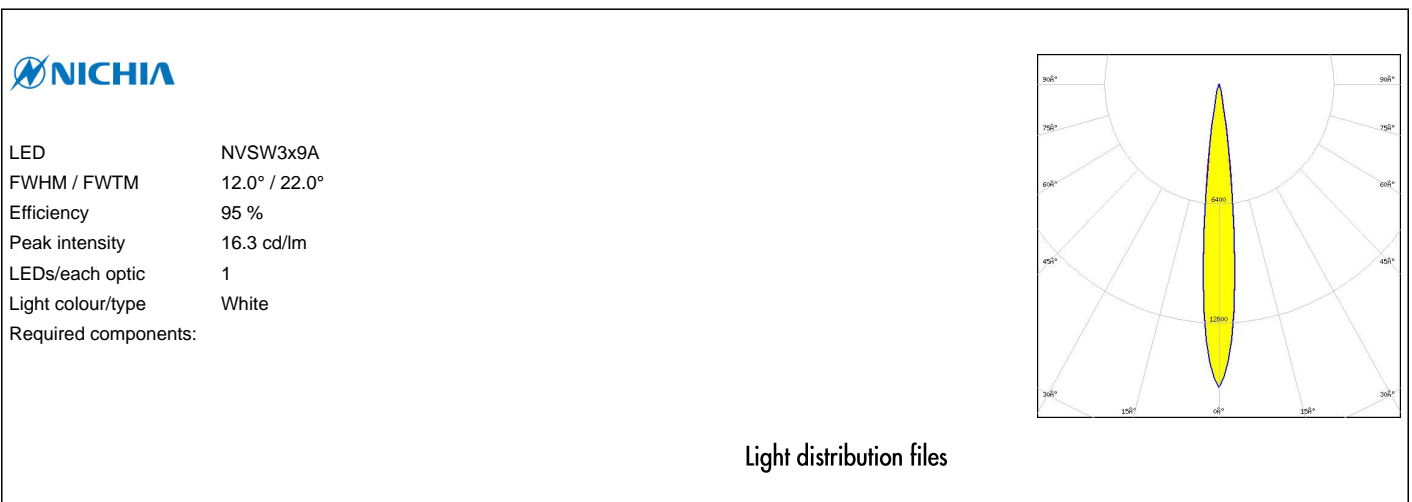
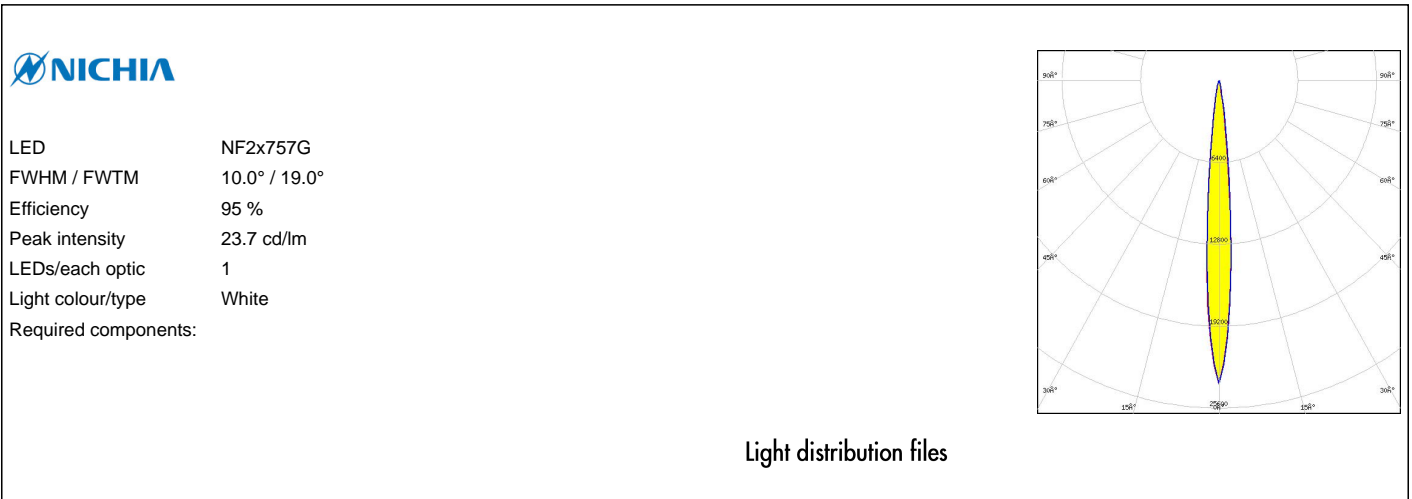

OPTICAL RESULTS (SIMULATED):

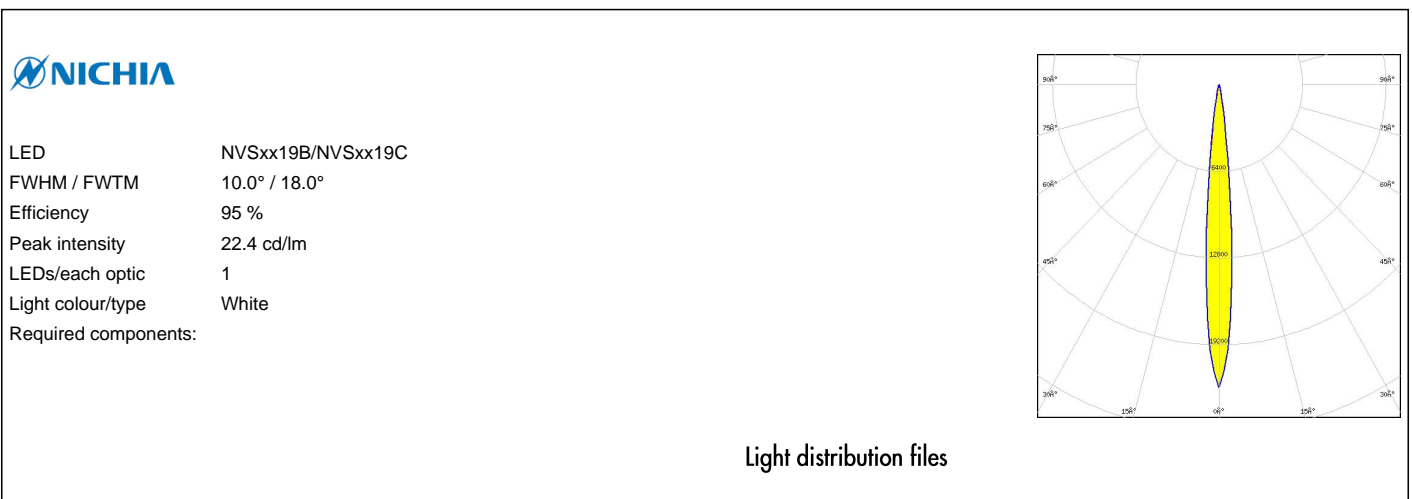
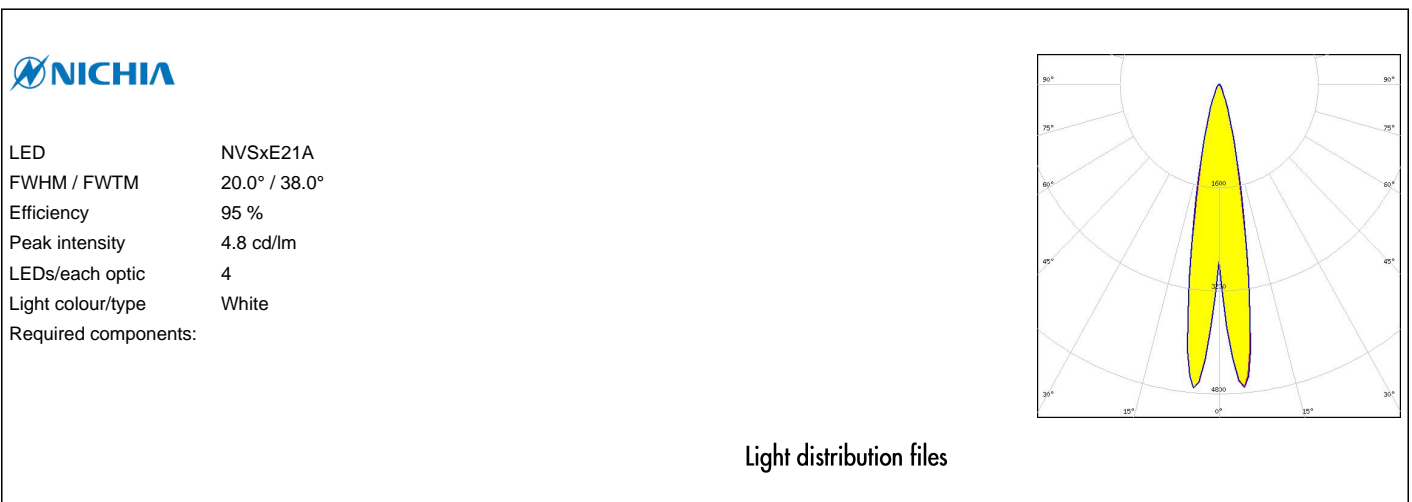
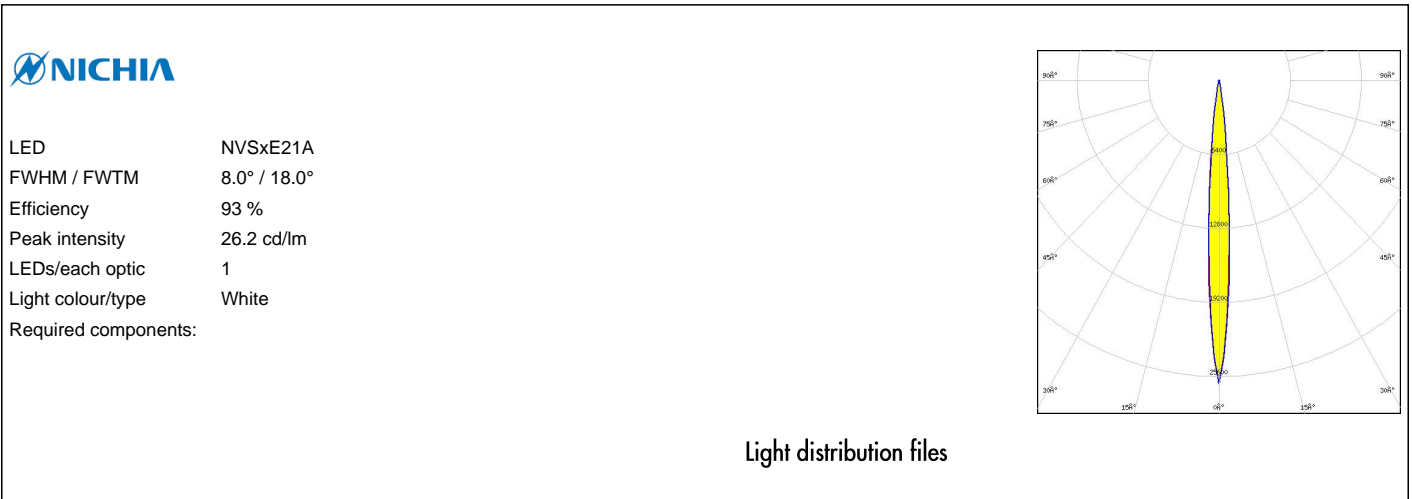

OPTICAL RESULTS (SIMULATED):

OSRAM
Opto Semiconductors

LED Duris S5 (Single chip)
 FWHM / FWTM 8.0° / 18.0°
 Efficiency 96 %
 Peak intensity 25.4 cd/lm
 LEDs/each optic 1
 Light colour/type White
 Required components:

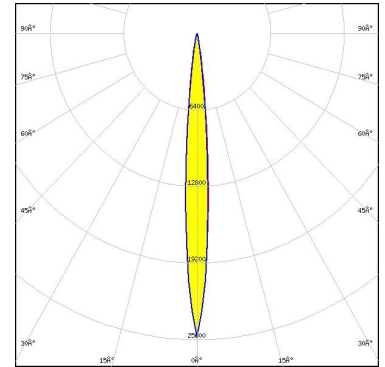

Light distribution files

OSRAM
Opto Semiconductors

LED Duris S5 (Single chip)
 FWHM / FWTM 9.0° / 18.0°
 Efficiency 89 %
 Peak intensity 23.2 cd/lm
 LEDs/each optic 1
 Light colour/type Purple
 Required components:

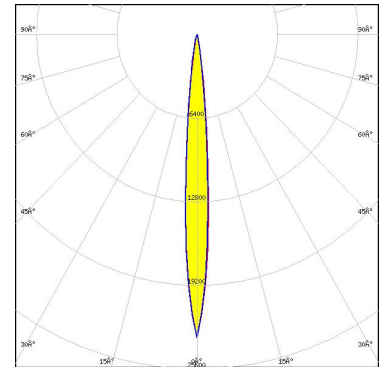

Light distribution files

OSRAM
Opto Semiconductors

LED OSCONIQ C 2424
 FWHM / FWTM 8.0° / 16.0°
 Efficiency 96 %
 Peak intensity 36.2 cd/lm
 LEDs/each optic 1
 Light colour/type White
 Required components:

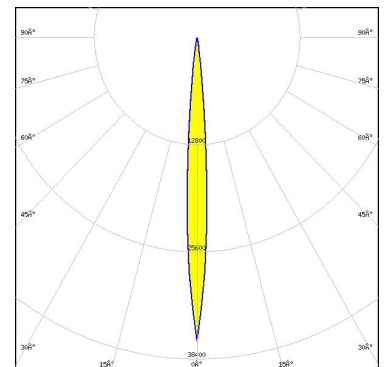

Light distribution files

OPTICAL RESULTS (SIMULATED):

OSRAM
Opto Semiconductors

LED OSCONIQ P 3030
FWHM / FWTM 10.0° / 20.0°
Efficiency 96 %
Peak intensity 20.8 cd/lm
LEDs/each optic 1
Light colour/type White
Required components:

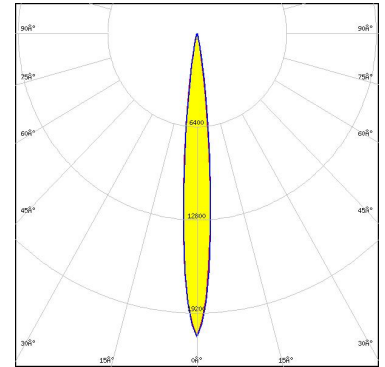

Light distribution files

OSRAM
Opto Semiconductors

LED OSLOM Black
FWHM / FWTM 11.0° / 20.0°
Efficiency 94 %
Peak intensity 19.7 cd/lm
LEDs/each optic 1
Light colour/type White
Required components:

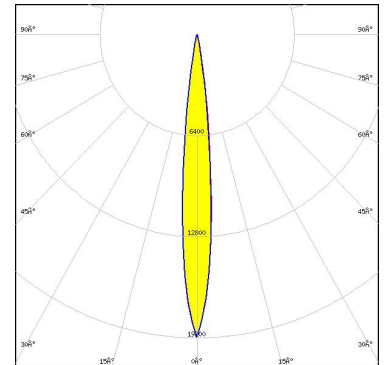

Light distribution files

OSRAM
Opto Semiconductors

LED OSLOM Black Flat (LUW HWQP)
FWHM / FWTM 6.3° / 14.0°
Efficiency 94 %
Peak intensity 50.4 cd/lm
LEDs/each optic 1
Light colour/type White
Required components:

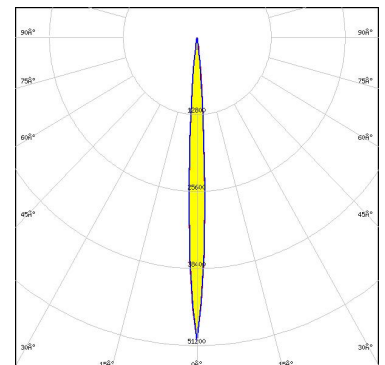

Light distribution files

OPTICAL RESULTS (SIMULATED):

OSRAM
Opto Semiconductors

LED OSLON PURE 1010
 FWHM / FWTM 8.0° / 16.0°
 Efficiency 93 %
 Peak intensity 29.8 cd/lm
 LEDs/each optic 1
 Light colour/type White
 Required components:

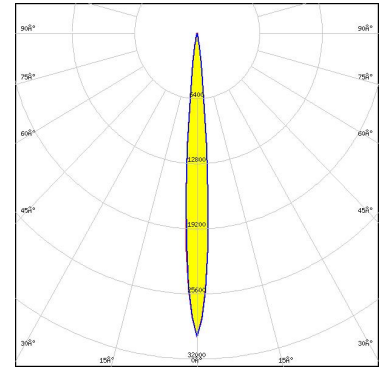

Light distribution files

OSRAM
Opto Semiconductors

LED OSLON Pure 1414
 FWHM / FWTM 6.0° / 12.0°
 Efficiency 96 %
 Peak intensity 61.2 cd/lm
 LEDs/each optic 1
 Light colour/type White
 Required components:

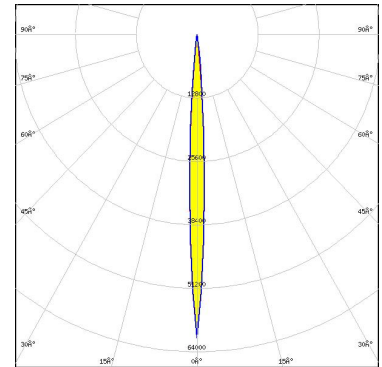

Light distribution files

OSRAM
Opto Semiconductors

LED OSLON Square CSSRM2/CSSRM3
 FWHM / FWTM 11.0° / 21.0°
 Efficiency 94 %
 Peak intensity 19.4 cd/lm
 LEDs/each optic 1
 Light colour/type White
 Required components:

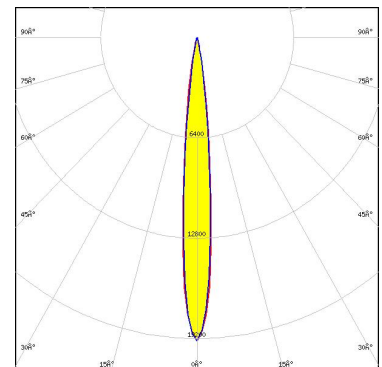

Light distribution files

OPTICAL RESULTS (SIMULATED):

OSRAM
Opto Semiconductors

LED OSLON SSL 120
FWHM / FWTM 7.0° / 14.0°
Efficiency 96 %
Peak intensity 45.5 cd/lm
LEDs/each optic 1
Light colour/type Amber
Required components:

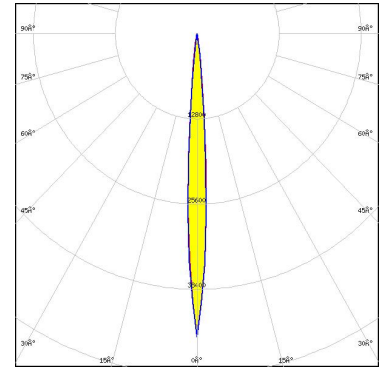

Light distribution files

OSRAM
Opto Semiconductors

LED OSLON SSL 150
FWHM / FWTM 7.0° / 14.0°
Efficiency 96 %
Peak intensity 44.5 cd/lm
LEDs/each optic 1
Light colour/type Amber
Required components:

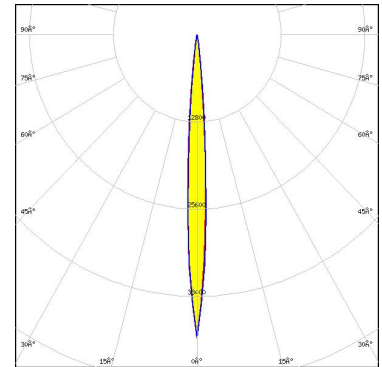

Light distribution files

OSRAM
Opto Semiconductors

LED OSLON SSL 150
FWHM / FWTM 6.0° / 14.0°
Efficiency 96 %
Peak intensity 47.7 cd/lm
LEDs/each optic 1
Light colour/type White
Required components:

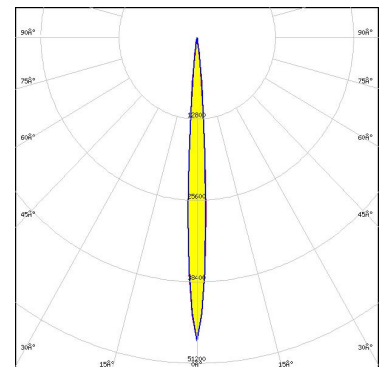

Light distribution files

OPTICAL RESULTS (SIMULATED):

OSRAM
Opto Semiconductors

LED OSLON SSL 80
FWHM / FWTM 7.0° / 14.0°
Efficiency 94 %
Peak intensity 38 cd/lm
LEDs/each optic 1
Light colour/type White
Required components:

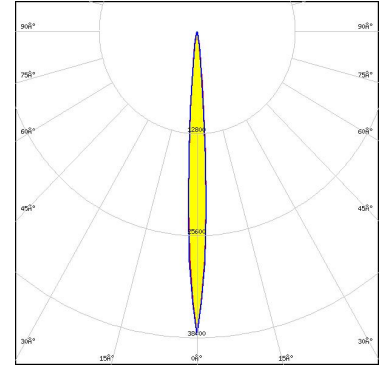

Light distribution files

OSRAM
Opto Semiconductors

LED SFH 4170S
FWHM / FWTM 6.0° / 11.0°
Efficiency 87 %
LEDs/each optic 1
Light colour/type IR
Required components:

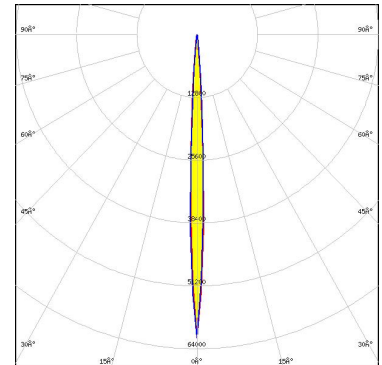

Light distribution files

OSRAM
Opto Semiconductors

LED SFH 4715AS
FWHM / FWTM 6.0° / 16.0°
Efficiency 96 %
LEDs/each optic 1
Light colour/type IR
Required components:

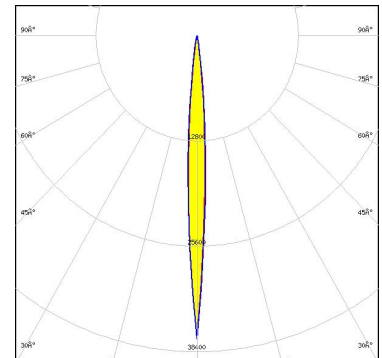
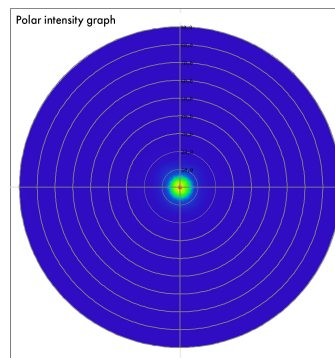

Light distribution files

OPTICAL RESULTS (SIMULATED):

OSRAM
Opto Semiconductors

LED SFH 4716AS
FWHM / FWTM 8.0° / 14.0°
Efficiency 96 %
LEDs/each optic 1
Light colour/type IR
Required components:

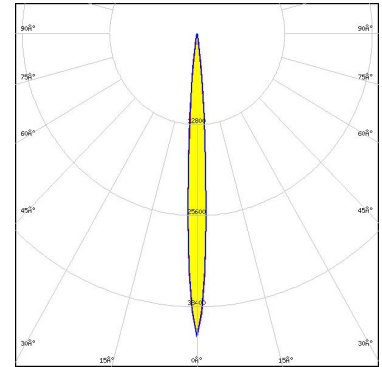

Light distribution files

OSRAM
Opto Semiconductors

LED SFH 4725AS
FWHM / FWTM 8.0° / 18.0°
Efficiency 95 %
LEDs/each optic 1
Light colour/type IR
Required components:

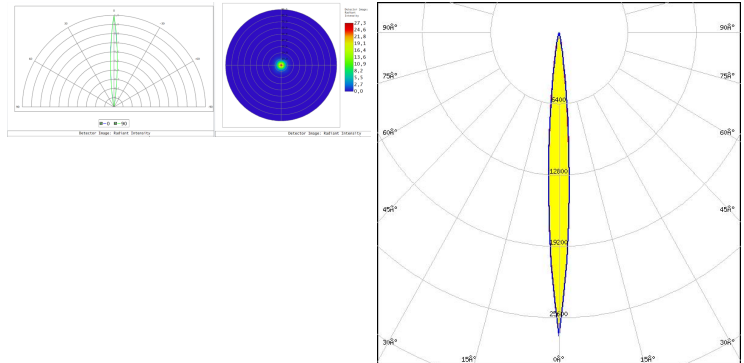

Light distribution files

SAMSUNG

LED LM301B
FWHM / FWTM 9.0° / 18.0°
Efficiency 94 %
Peak intensity 28.5 cd/lm
LEDs/each optic 1
Light colour/type White
Required components:

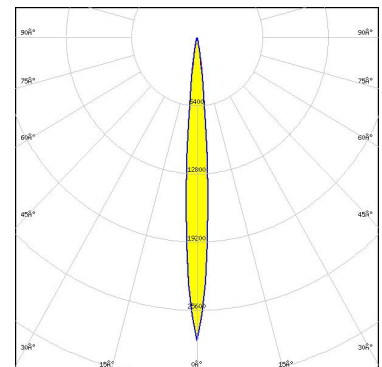

Light distribution files

GENERAL INFORMATION:

NOTE: The typical beam angle will be changed by different color, chip size and chip position tolerance. The typical total beam angle is the full angle measured where the luminous intensity is half of the peak value.

MATERIALS:

As part of our continuous research and improvement processes, and to ensure the best possible quality and availability of our products, LEDiL reserves the right to change material grades without notice.

PRODUCT DATA USER AGREEMENT AND DISCLAIMER:

The measured data in the provided downloadable LEDiL Product Datasheets and Mechanical 2D-Drawings is rounded and provided as reference for planning. LEDiL Oy's optical specifications have been verified by conducting performance testing of the products in accordance with the company's quality system. The reported data are averaged results of multiple measurements with typical variation. LEDiL Oy reserves the right to without prior notification make changes and improvements to its products.

LEDiL Oy assumes neither warranty, nor guarantee nor any other liability of any kind for the contents and correctness of the provided data. The provided data has been generated with highest diligence but the provided data may in reality not represent the complete possible variation range of all intrinsic parameters. Therefore, in certain cases a deviation from the provided data could occur.

LEDiL Oy reserves the right to undertake technical changes of its products without further notification which could lead to changes in the provided data. LEDiL Oy assumes no liability of any kind for the possible deviation from any provided data or any other damage resulting from the usage of the provided data.

The user agrees to this disclaimer and user agreement with the download or usage of the provided files.

LEDiL Oy

Joensuunkatu 7
FI-24100 SALO
Finland

LEDiL Inc.

228 West Page Street
Suite D
Sycamore IL 60178
USA

Ledil Optics Technology (Shenzhen) Co., Ltd.

405 , Block B
Casic Motor Building
Shenzhen 518057
P.R.CHINA

Local sales and technical support

[www.ledil.com/
where_to_buy](http://www.ledil.com/where_to_buy)

Shipping locations

Poznan, Poland
Hong Kong, China

Distribution Partners

[www.ledil.com/
where_to_buy](http://www.ledil.com/where_to_buy)