

EVA-D

~16° diffused spot beam. Assembly with holder including location pins and installation tape.

SPECIFICATION:

Dimensions	Ø 37.7 mm
Height	17.2 mm
Fastening	tape, pin
ROHS compliant	yes ⓘ



LEDiL

MATERIALS:

Component	Type	Material	Colour	Finish	Length
EVA-D	Single lens	PMMA	clear		35.0
EVA-HLD-PIN	Holder	PC	black		37.6
SPUTNIK-TAPE3	Tape	Acrylic foam	black		25.0

ORDERING INFORMATION:

Component	Qty in box	MOQ	MPQ	Box weight (kg)
CA14308_EVA-D » Box size: 480 x 280 x 300 mm	675	90	45	0.0

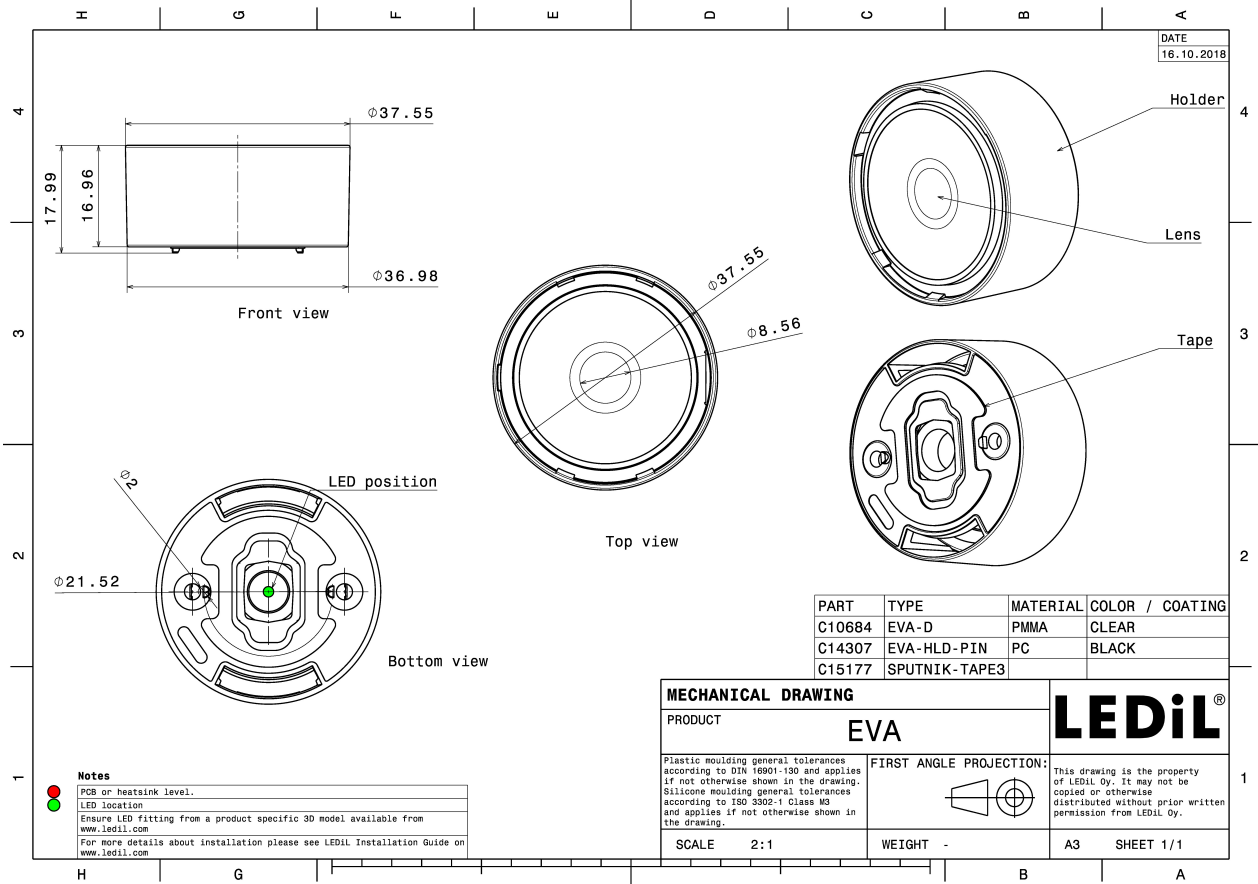

See also our general installation guide: www.ledil.com/installation_guide

OPTICAL RESULTS (MEASURED):

LUMILEDS

LED LUXEON M/MX
FWHM / FWTM 21.0° / 43.0°
Efficiency 89 %
Peak intensity 4.2 cd/lm
LEDs/each optic 1
Light colour/type White
Required components:

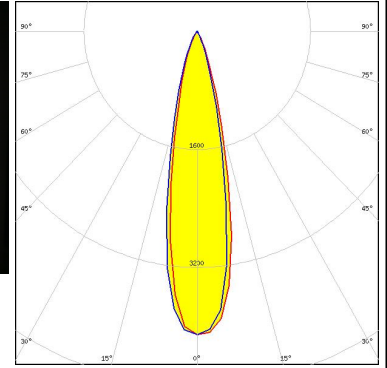

Light distribution files

NICHIA

LED NVSW219F
FWHM / FWTM 14.0° / 29.0°
Efficiency 90 %
Peak intensity 9.7 cd/lm
LEDs/each optic 1
Light colour/type White
Required components:

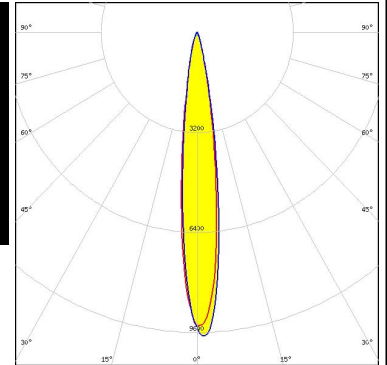
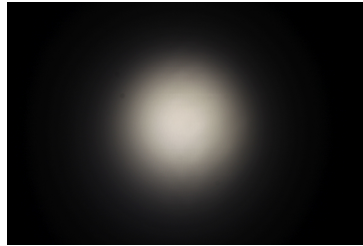

Light distribution files

OPTICAL RESULTS (SIMULATED):



LED XE-G
FWHM / FWTM 16.0° / 26.0°
Efficiency 93 %
Peak intensity 10.5 cd/lm
LEDs/each optic 1
Light colour/type White
Required components:

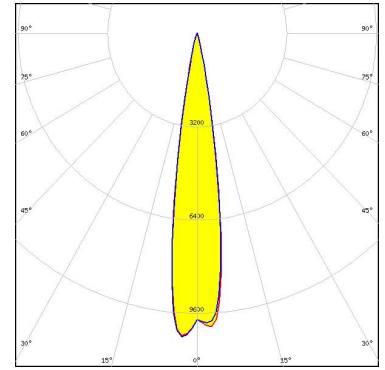

Light distribution files



LED XHP35 HI
FWHM / FWTM 15.0° / 28.0°
Efficiency 94 %
Peak intensity 11 cd/lm
LEDs/each optic 1
Light colour/type White
Required components:

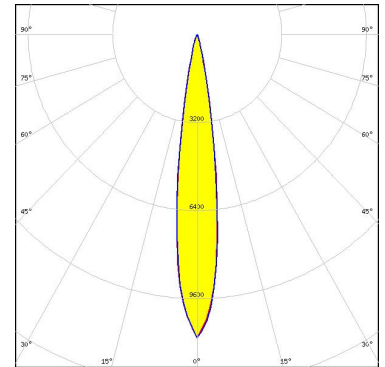

Light distribution files



LED XHP35.2 HD
FWHM / FWTM 24.0° / 39.0°
Efficiency 89 %
Peak intensity 4.9 cd/lm
LEDs/each optic 1
Light colour/type White
Required components:

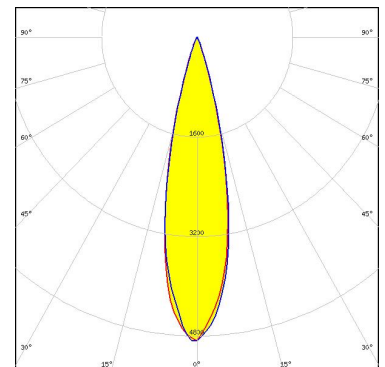

Light distribution files

OPTICAL RESULTS (SIMULATED):



LED XP-E2
FWHM / FWTM 16.0° / 26.0°
Efficiency 94 %
Peak intensity 10.7 cd/lm
LEDs/each optic 1
Light colour/type White

Required components:

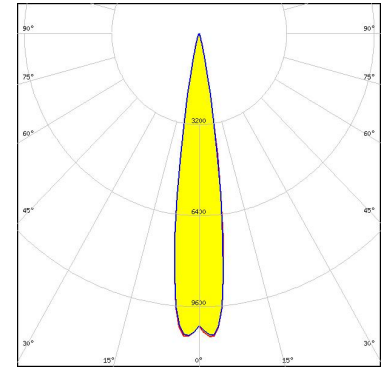

Light distribution files



LED LUXEON M/MX
FWHM / FWTM 20.0° / 37.0°
Efficiency 92 %
Peak intensity 5.9 cd/lm
LEDs/each optic 1
Light colour/type White

Required components:

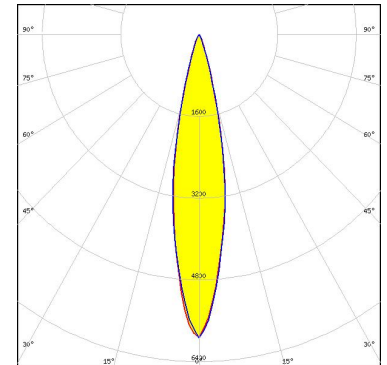

Light distribution files



LED OSCONIQ C 2424
FWHM / FWTM 22.0° / 38.0°
Efficiency 94 %
Peak intensity 5.6 cd/lm
LEDs/each optic 4
Light colour/type White

Required components:

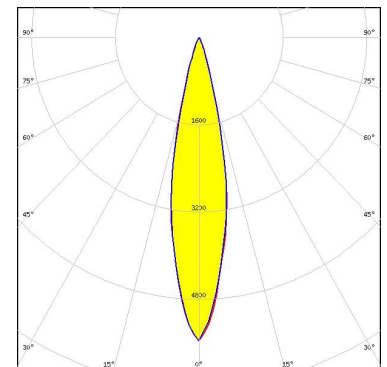

Light distribution files

OPTICAL RESULTS (SIMULATED):

 SEOUL SEMICONDUCTOR	
LED	Z8Y22P
FWHM / FWTM	17.0° / 30.0°
Efficiency	98 %
Peak intensity	9.5 cd/lm
LEDs/each optic	1
Light colour/type	White
Required components:	

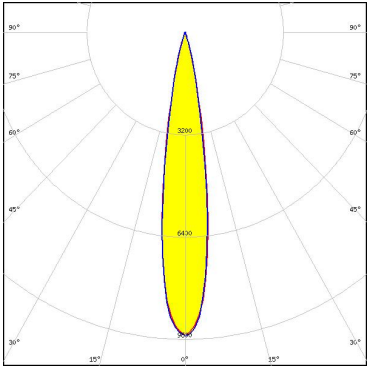

Light distribution files

GENERAL INFORMATION:

NOTE: The typical beam angle will be changed by different color, chip size and chip position tolerance. The typical total beam angle is the full angle measured where the luminous intensity is half of the peak value.

MATERIALS:

As part of our continuous research and improvement processes, and to ensure the best possible quality and availability of our products, LEDiL reserves the right to change material grades without notice.

PRODUCT DATA USER AGREEMENT AND DISCLAIMER:

The measured data in the provided downloadable LEDiL Product Datasheets and Mechanical 2D-Drawings is rounded and provided as reference for planning. LEDiL Oy's optical specifications have been verified by conducting performance testing of the products in accordance with the company's quality system. The reported data are averaged results of multiple measurements with typical variation. LEDiL Oy reserves the right to without prior notification make changes and improvements to its products.

LEDiL Oy assumes neither warranty, nor guarantee nor any other liability of any kind for the contents and correctness of the provided data. The provided data has been generated with highest diligence but the provided data may in reality not represent the complete possible variation range of all intrinsic parameters. Therefore, in certain cases a deviation from the provided data could occur.

LEDiL Oy reserves the right to undertake technical changes of its products without further notification which could lead to changes in the provided data. LEDiL Oy assumes no liability of any kind for the possible deviation from any provided data or any other damage resulting from the usage of the provided data.

The user agrees to this disclaimer and user agreement with the download or usage of the provided files.

LEDiL Oy

Joensuunkatu 13
FI-24240 SALO
Finland

LEDiL Inc.

228 West Page Street
Suite D
Sycamore IL 60178
USA

Ledil Optics Technology (Shenzhen) Co., Ltd.

405 , Block B
Casic Motor Building
Shenzhen 518057
P.R.CHINA

Local sales and technical support

[www.ledil.com/
where_to_buy](http://www.ledil.com/where_to_buy)

Shipping locations

Poznan, Poland
Hong Kong, China

Distribution Partners

[www.ledil.com/
where_to_buy](http://www.ledil.com/where_to_buy)