

FLARE-MAXI-D

34 x 33 mm lens with ~110° x 15° diffused oval beam

SPECIFICATION:

Dimensions	33.9 x 33.3
Height	16.5 mm
Fastening	glue, pin
ROHS compliant	yes ⓘ



MATERIALS:

Component	Type	Material	Colour	Finish	Length (mm)
FLARE-MAXI-D	Single lens	PMMA	clear		

ORDERING INFORMATION:

Component	Qty in box	MOQ	MPQ	Box weight (kg)
C13012_FLARE-MAXI-D » Box size: 451 x 254 x 197 mm	840		168	9.7

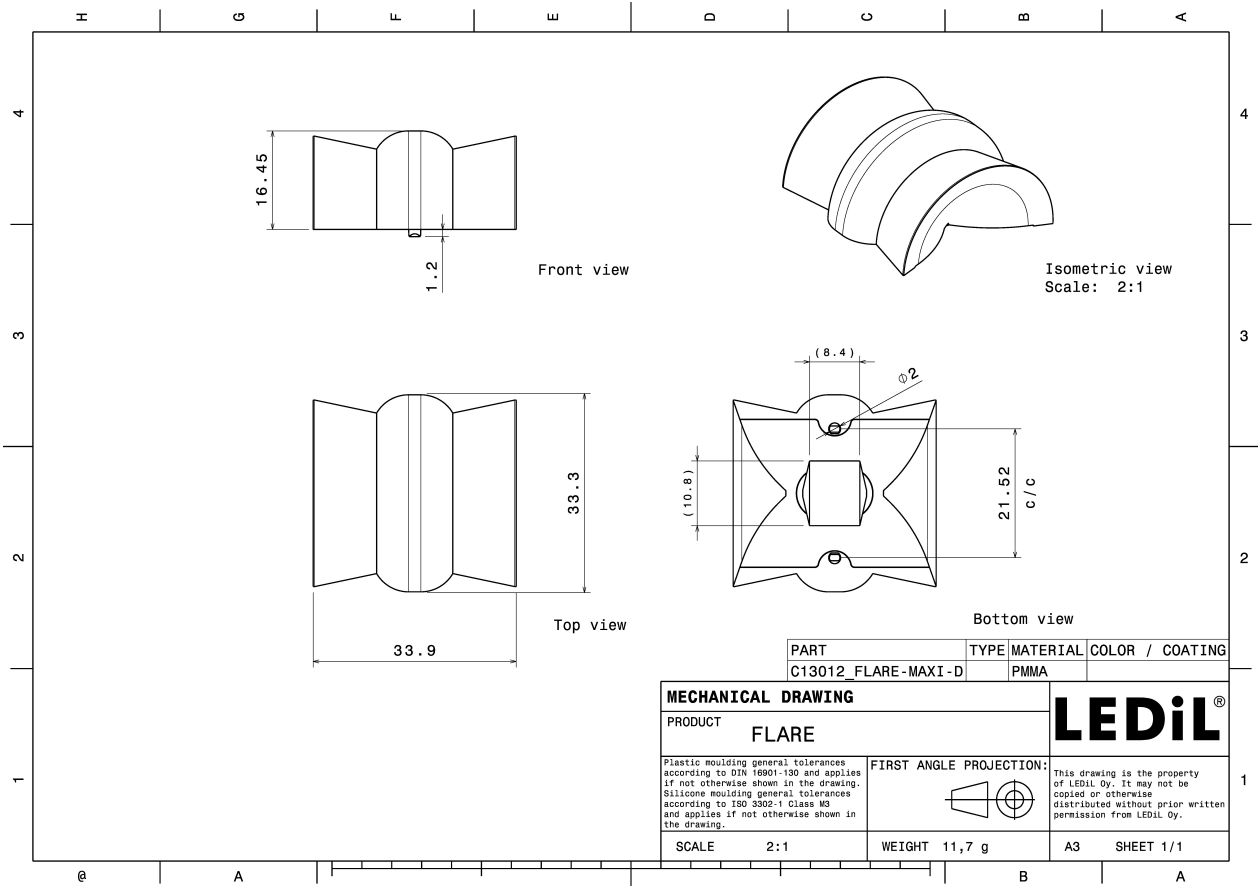

See also our general installation guide: www.ledil.com/installation_guide

OPTICAL RESULTS (MEASURED):



LED MK-R
 FWHM / FWTM 100.0 + 23.0° / 148.0 + 36.0°
 Efficiency 92 %
 Peak intensity 1.2 cd/lm
 LEDs/each optic 1
 Light colour/type White
 Required components:

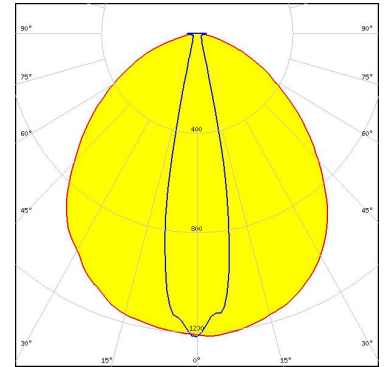

Light distribution files



LED XHP50
 FWHM / FWTM 104.0 + 19.0° / 151.0 + 35.0°
 Efficiency 92 %
 Peak intensity 1.3 cd/lm
 LEDs/each optic 1
 Light colour/type White
 Required components:

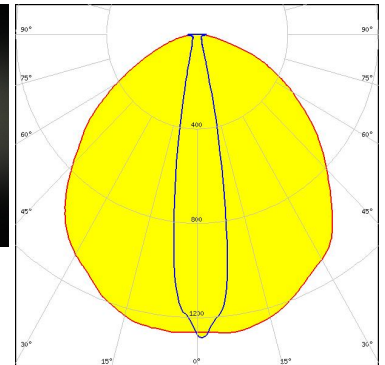
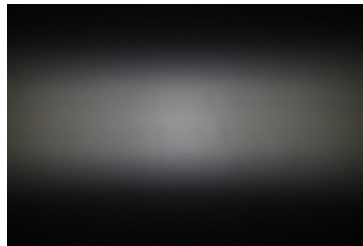

Light distribution files



LED XHP70
 FWHM / FWTM 104.0 + 28.0° / 153.0 + 44.0°
 Efficiency 92 %
 Peak intensity 0.9 cd/lm
 LEDs/each optic 1
 Light colour/type White
 Required components:

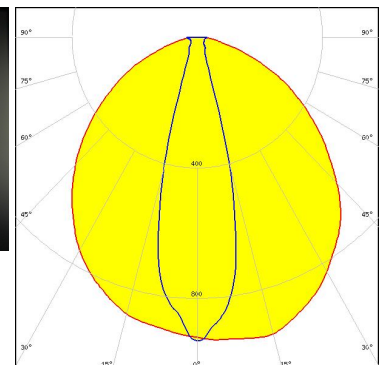
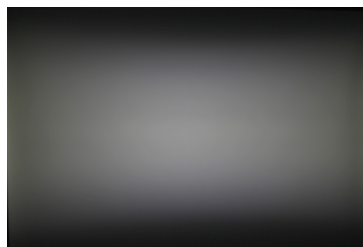

Light distribution files

OPTICAL RESULTS (MEASURED):



LED XM-L
 FWHM / FWTM 110.0 + 15.0° / 151.0 + 27.0°
 Efficiency 94 %
 Peak intensity 1.7 cd/lm
 LEDs/each optic 1
 Light colour/type White
 Required components:

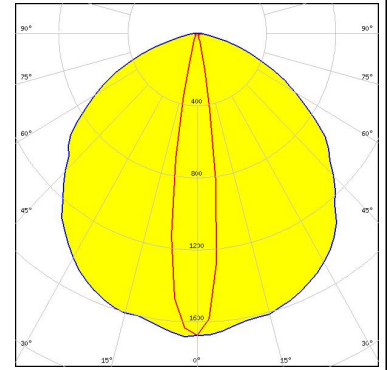

Light distribution files



LED XM-L2
 FWHM / FWTM 101.0 + 17.0° / 146.0 + 28.0°
 Efficiency 94 %
 Peak intensity 1.9 cd/lm
 LEDs/each optic 1
 Light colour/type White
 Required components:

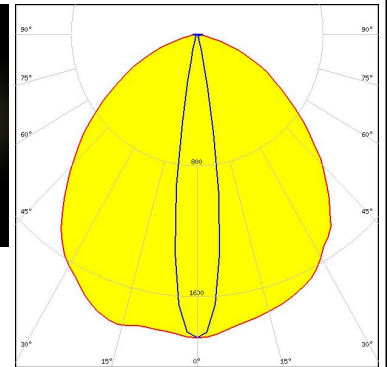
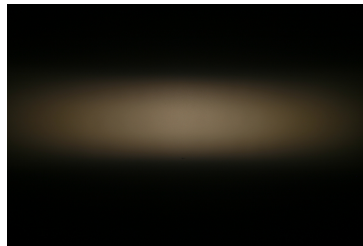

Light distribution files



LED XP-G
 FWHM / FWTM 115.0 + 15.0° / 155.0 + 23.0°
 Efficiency 94 %
 Peak intensity 1.9 cd/lm
 LEDs/each optic 1
 Light colour/type White
 Required components:

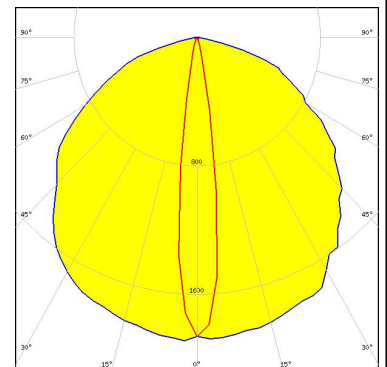

Light distribution files

OPTICAL RESULTS (MEASURED):



LED XP-G2
 FWHM / FWTM 106.0 + 14.0° / 150.0 + 24.0°
 Efficiency 94 %
 Peak intensity 2 cd/lm
 LEDs/each optic 1
 Light colour/type White
 Required components:

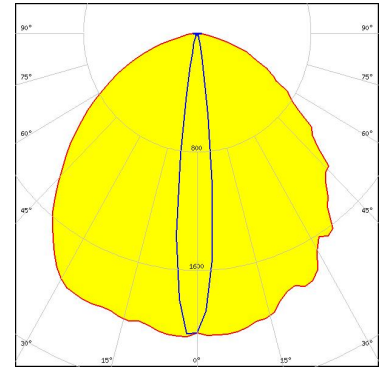

Light distribution files



LED XP-L HD
 FWHM / FWTM 119.0 + 16.0° / 154.0 + 27.0°
 Efficiency 94 %
 Peak intensity 1.5 cd/lm
 LEDs/each optic 1
 Light colour/type White
 Required components:

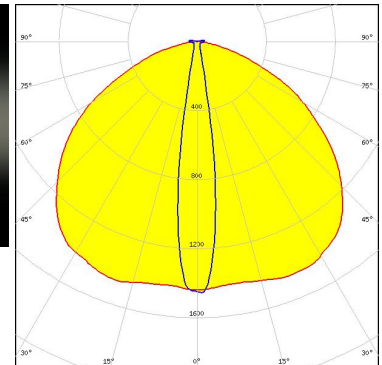
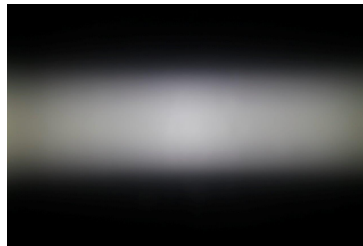

Light distribution files



LED XP-L2
 FWHM / FWTM 107.0 + 16.0° / 159.0 + 28.0°
 Efficiency 94 %
 Peak intensity 1.5 cd/lm
 LEDs/each optic 1
 Light colour/type White
 Required components:

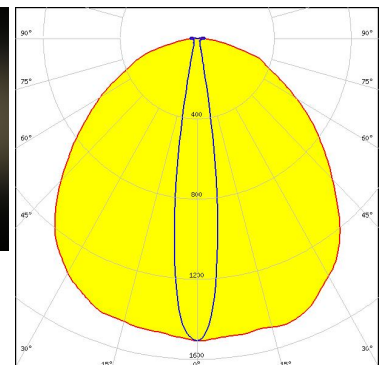
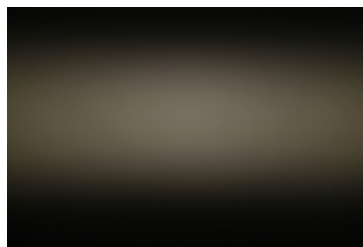

Light distribution files

OPTICAL RESULTS (MEASURED):



LED XT-E
 FWHM / FWTM 117.0 + 14.0° / 159.0 + 26.0°
 Efficiency 94 %
 Peak intensity 1.9 cd/lm
 LEDs/each optic 1
 Light colour/type White
 Required components:

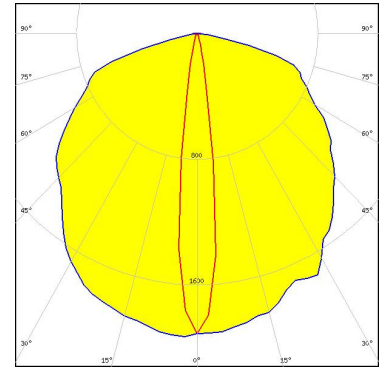

Light distribution files



LED LUXEON A
 FWHM / FWTM 104.0 + 12.0° / 147.0 + 25.0°
 Efficiency 94 %
 Peak intensity 2.1 cd/lm
 LEDs/each optic 1
 Light colour/type White
 Required components:

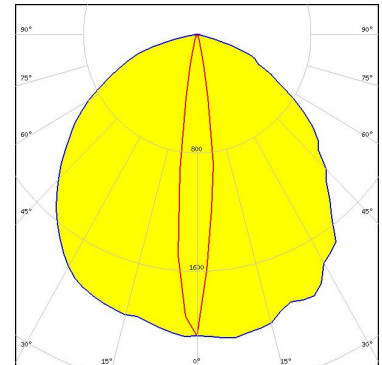

Light distribution files



LED LUXEON M/MX
 FWHM / FWTM 102.0 + 25.0° / 146.0 + 39.0°
 Efficiency 94 %
 Peak intensity 1.4 cd/lm
 LEDs/each optic 1
 Light colour/type White
 Required components:

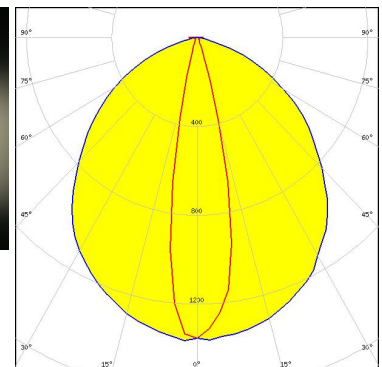
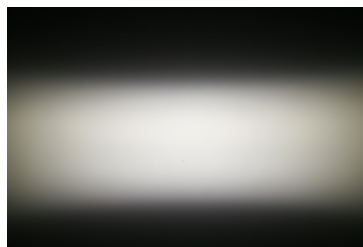

Light distribution files

OPTICAL RESULTS (MEASURED):



LED LUXEON MZ
FWHM / FWTM 101.0 + 16.0° / 146.0 + 27.0°
Efficiency 94 %
Peak intensity 1.9 cd/lm
LEDs/each optic 1
Light colour/type White
Required components:

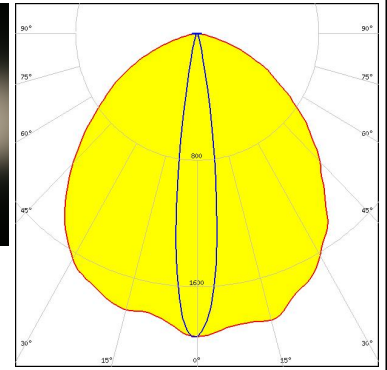

Light distribution files



LED LUXEON Rebel ES
FWHM / FWTM 104.0 + 13.0° / 150.0 + 25.0°
Efficiency 94 %
Peak intensity 2 cd/lm
LEDs/each optic 1
Light colour/type White
Required components:

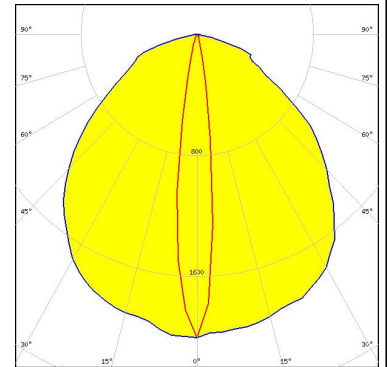

Light distribution files



LED LUXEON T
FWHM / FWTM 102.0 + 13.0° / 149.0 + 25.0°
Efficiency 92 %
Peak intensity 1.8 cd/lm
LEDs/each optic 1
Light colour/type White
Required components:

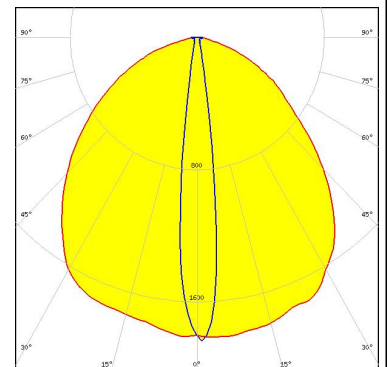

Light distribution files

OPTICAL RESULTS (MEASURED):



LED LUXEON TX
 FWHM / FWTM 103.0 + 13.0° / 143.0 + 22.0°
 Efficiency 93 %
 Peak intensity 2.1 cd/lm
 LEDs/each optic 1
 Light colour/type White
 Required components:

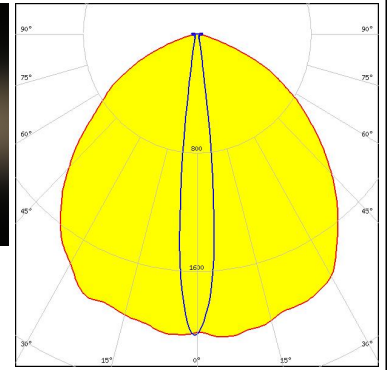
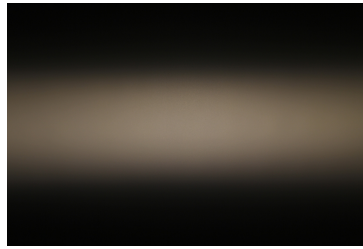

Light distribution files



LED NCSxx19B
 FWHM / FWTM 107.0 + 13.0° / 156.0 + 23.0°
 Efficiency 94 %
 Peak intensity 2.1 cd/lm
 LEDs/each optic 1
 Light colour/type White
 Required components:

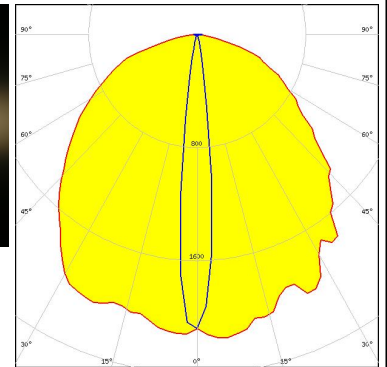
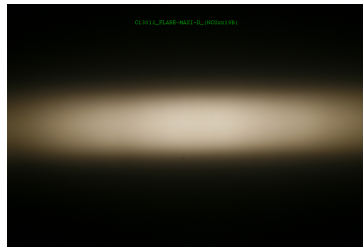

Light distribution files



LED NS9x383
 FWHM / FWTM 110.0 + 16.0° / 152.0 + 30.0°
 Efficiency 93 %
 Peak intensity 1.5 cd/lm
 LEDs/each optic 1
 Light colour/type White
 Required components:

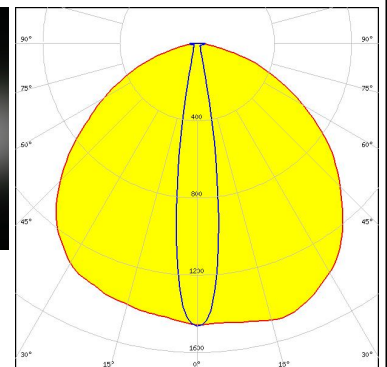
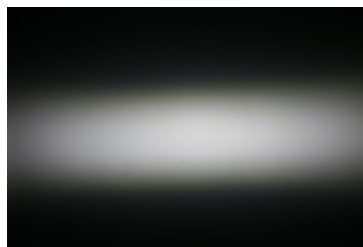

Light distribution files

OPTICAL RESULTS (MEASURED):

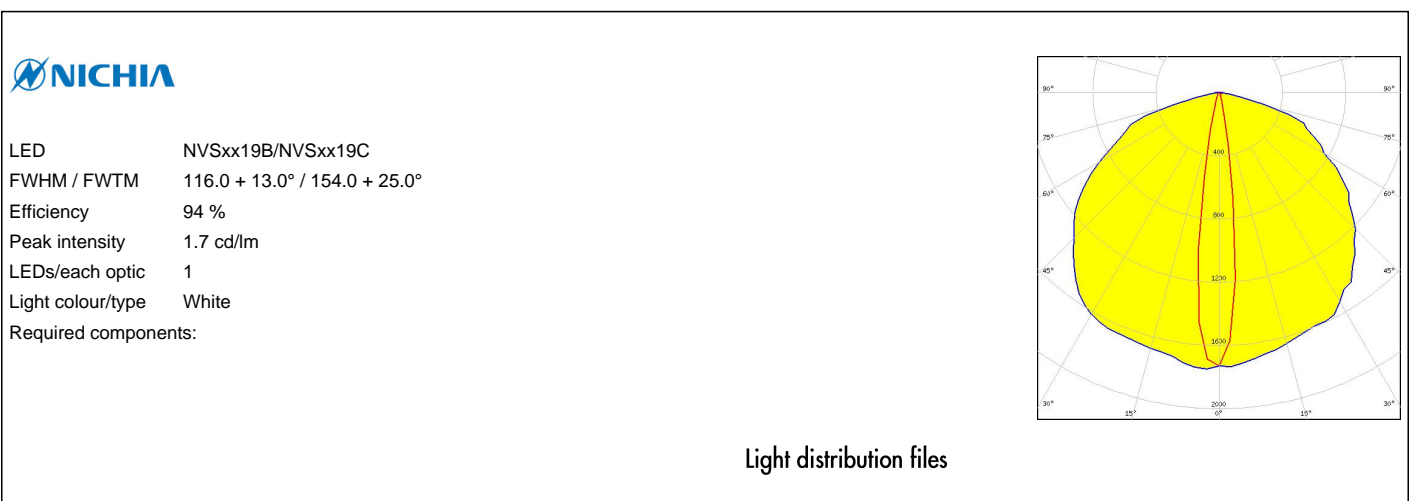
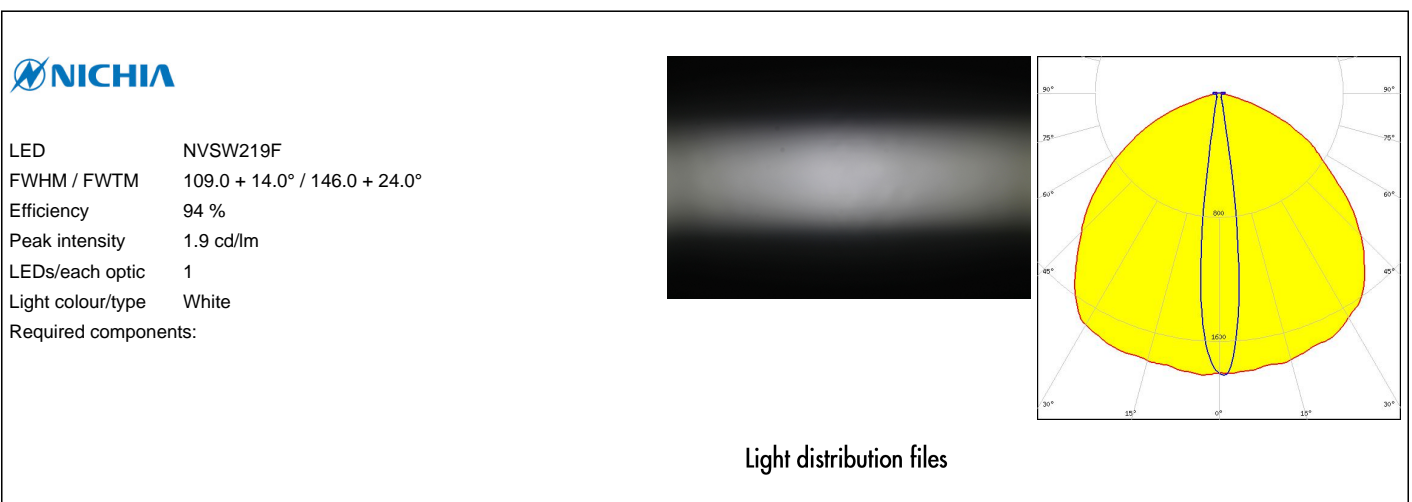
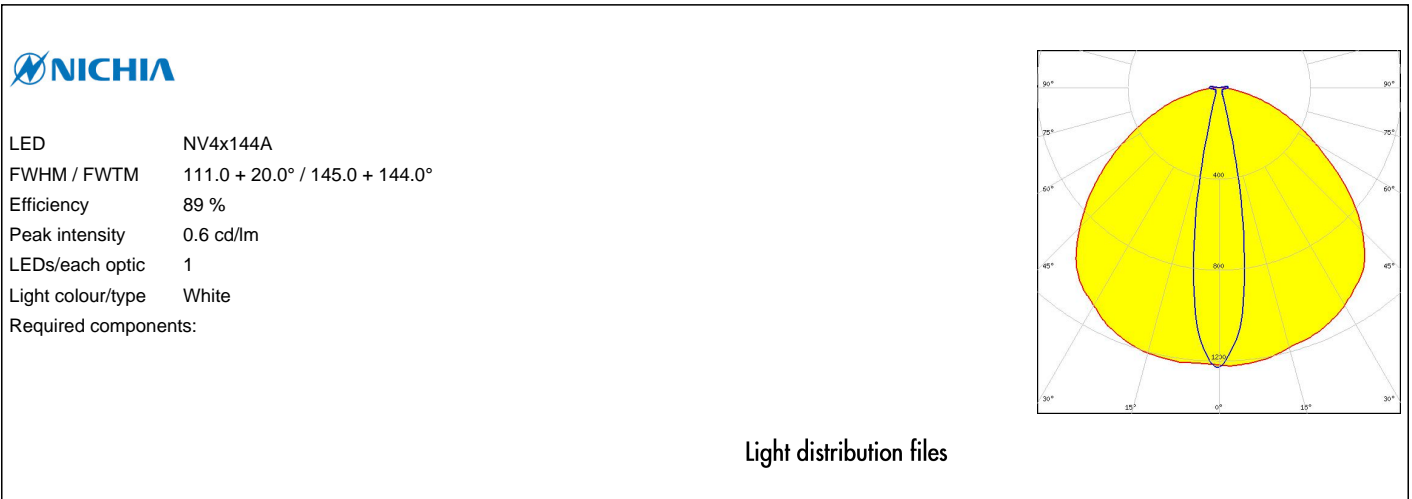

OPTICAL RESULTS (MEASURED):

NICHIA

LED	NWSx229A
FWHM / FWTM	117.0 + 15.0° / 151.0 + 26.0°
Efficiency	92 %
Peak intensity	1.6 cd/lm
LEDs/each optic	1
Light colour/type	White
Required components:	

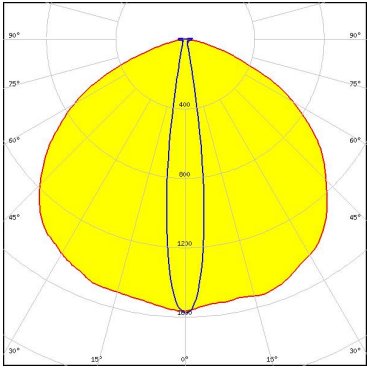
Light distribution files

OSRAM
Opto Semiconductors

LED	Duris S10
FWHM / FWTM	92.0 + 20.0° / 144.0 + 36.0°
Efficiency	93 %
Peak intensity	1.6 cd/lm
LEDs/each optic	1
Light colour/type	White
Required components:	



Light distribution files

OSRAM
Opto Semiconductors

LED	OSLON Square EC
FWHM / FWTM	99.0 + 14.0° / 149.0 + 27.0°
Efficiency	94 %
Peak intensity	2 cd/lm
LEDs/each optic	1
Light colour/type	White
Required components:	

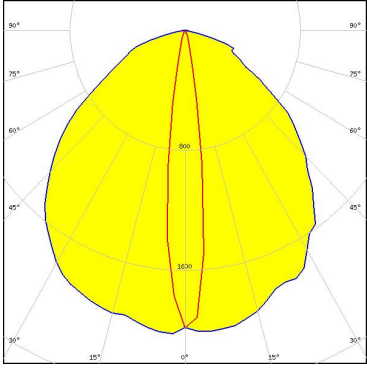

Light distribution files

OPTICAL RESULTS (MEASURED):

OSRAM
Opto Semiconductors

LED OSLON Square PC
FWHM / FWTM 104.0 + 12.0° / 150.0 + 25.0°
Efficiency 94 %
Peak intensity 2 cd/lm
LEDs/each optic 1
Light colour/type White
Required components:

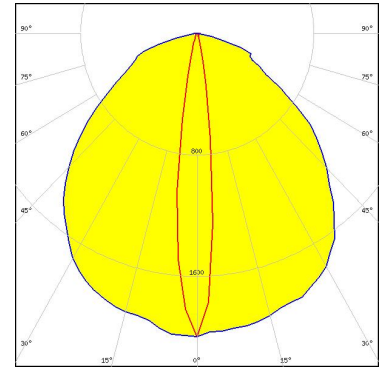

Light distribution files

OSRAM
Opto Semiconductors

LED OSLON SSL 150
FWHM / FWTM 128.0 + 13.0° / 152.0 + 23.0°
Efficiency 94 %
Peak intensity 2 cd/lm
LEDs/each optic 1
Light colour/type White
Required components:

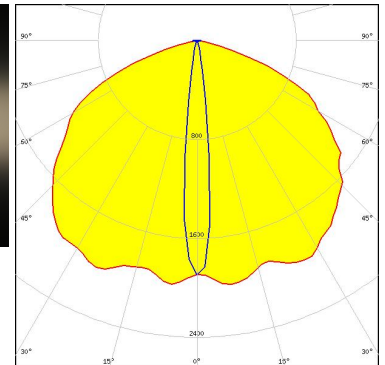
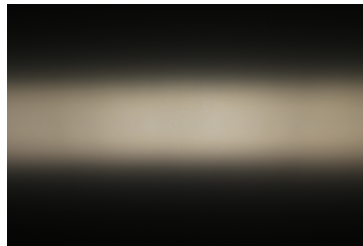

Light distribution files

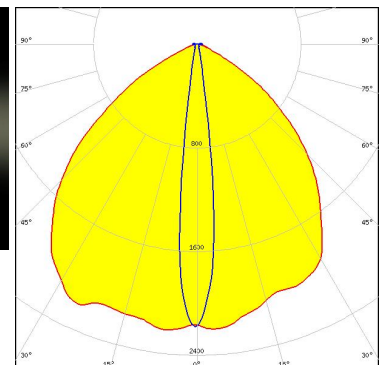
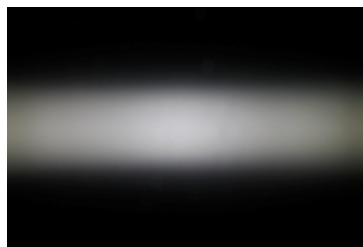

SAMSUNG

LED LH351Z
FWHM / FWTM 98.0 + 13.0° / 128.0 + 22.0°
Efficiency 94 %
Peak intensity 2.2 cd/lm
LEDs/each optic 1
Light colour/type White
Required components:



Light distribution files

OPTICAL RESULTS (MEASURED):

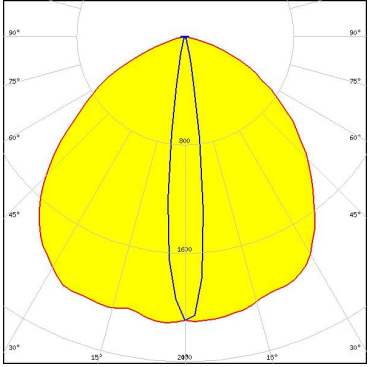
 <small>SEOUL SEMICONDUCTOR</small>			
LED	Z5M1/Z5M2		
FWHM / FWTM	104.0 + 14.0° / 144.0 + 25.0°		
Efficiency	94 %		
Peak intensity	2.1 cd/m		
LEDs/each optic	1		
Light colour/type	White		
Required components:		<p>Light distribution files</p>	

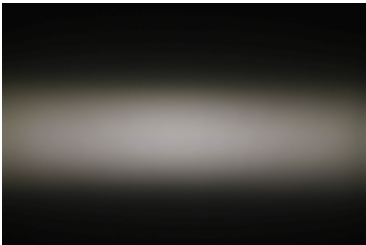
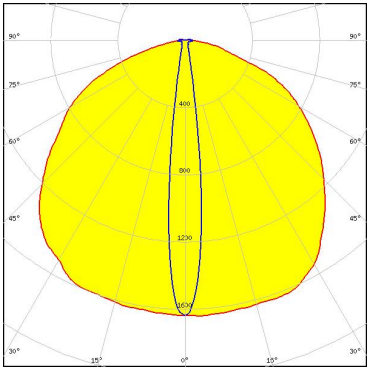
 <small>SEOUL SEMICONDUCTOR</small>			
LED	Z8Y22P		
FWHM / FWTM	117.0 + 13.0° / 158.0 + 25.0°		
Efficiency	94 %		
Peak intensity	1.6 cd/m		
LEDs/each optic	1		
Light colour/type	White		
Required components:		<p>Light distribution files</p>	

OPTICAL RESULTS (SIMULATED):



LED XHP50.2
 FWHM / FWTM 92.0 + 20.0° / 144.0 + 34.0°
 Efficiency 94 %
 Peak intensity 1.5 cd/lm
 LEDs/each optic 1
 Light colour/type White
 Required components:

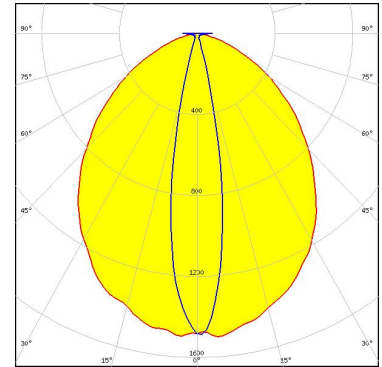

Light distribution files



LED XHP50.3 HD
 FWHM / FWTM 88.0 + 18.0° / 139.0 + 30.0°
 Efficiency 95 %
 Peak intensity 1.7 cd/lm
 LEDs/each optic 1
 Light colour/type White
 Required components:

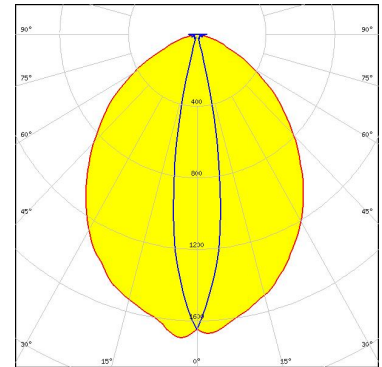

Light distribution files



LED XP-G2 HE
 FWHM / FWTM 84.0 + 13.0° / 140.0 + 21.0°
 Efficiency 95 %
 Peak intensity 2.3 cd/lm
 LEDs/each optic 1
 Light colour/type White
 Required components:

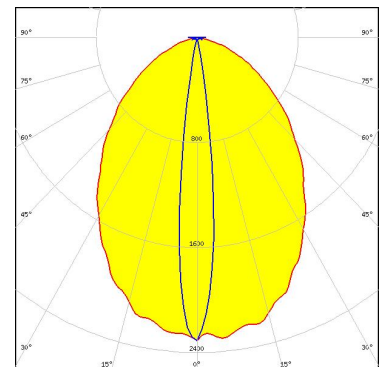

Light distribution files

OPTICAL RESULTS (SIMULATED):



LED XP-G3
 FWHM / FWTM 82.0 + 12.0° / 145.0 + 20.0°
 Efficiency 95 %
 Peak intensity 2.4 cd/lm
 LEDs/each optic 1
 Light colour/type White
 Required components:

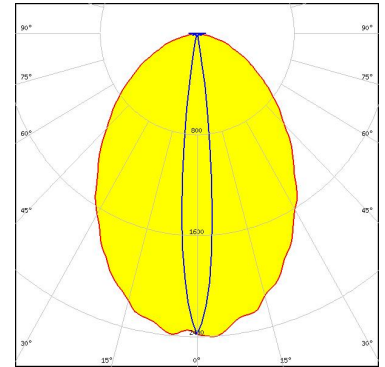

Light distribution files



LED LUXEON 7070
 FWHM / FWTM 89.0 + 22.0° / 144.0 + 38.0°
 Efficiency 95 %
 Peak intensity 1.4 cd/lm
 LEDs/each optic 1
 Light colour/type White
 Required components:

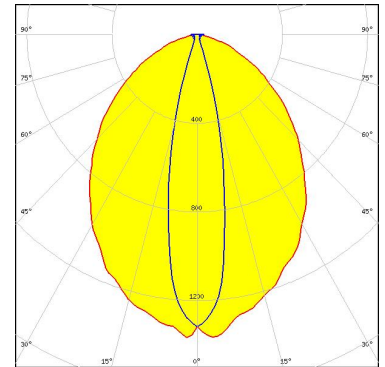

Light distribution files



LED LUXEON H50-2
 FWHM / FWTM 10.0 + 65.0° / 18.0 + 126.0°
 Efficiency 92 %
 Peak intensity 3.3 cd/lm
 LEDs/each optic 1
 Light colour/type White
 Required components:

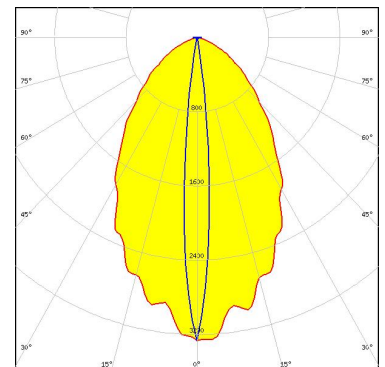

Light distribution files

OPTICAL RESULTS (SIMULATED):

OSRAM
Opto Semiconductors

LED OSCONIQ P 7070
FWHM / FWTM 86.0 + 18.0° / 142.0 + 28.0°
Efficiency 92 %
Peak intensity 1.7 cd/lm
LEDs/each optic 1
Light colour/type White
Required components:

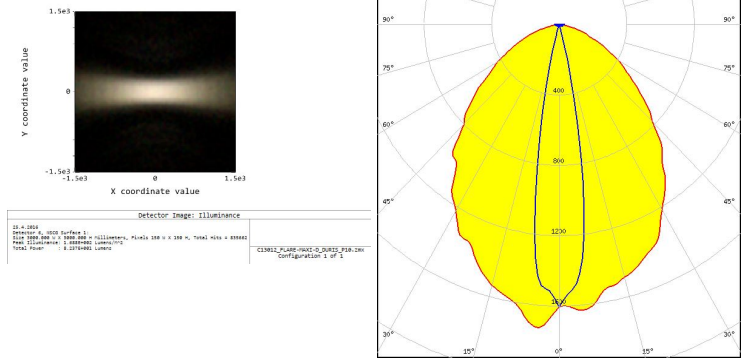

Light distribution files

GENERAL INFORMATION:

NOTE: The typical beam angle will be changed by different color, chip size and chip position tolerance. The typical total beam angle is the full angle measured where the luminous intensity is half of the peak value.

MATERIALS:

As part of our continuous research and improvement processes, and to ensure the best possible quality and availability of our products, LEDiL reserves the right to change material grades without notice.

PRODUCT DATA USER AGREEMENT AND DISCLAIMER:

The measured data in the provided downloadable LEDiL Product Datasheets and Mechanical 2D-Drawings is rounded and provided as reference for planning. LEDiL Oy's optical specifications have been verified by conducting performance testing of the products in accordance with the company's quality system. The reported data are averaged results of multiple measurements with typical variation. LEDiL Oy reserves the right to without prior notification make changes and improvements to its products.

LEDiL Oy assumes neither warranty, nor guarantee nor any other liability of any kind for the contents and correctness of the provided data. The provided data has been generated with highest diligence but the provided data may in reality not represent the complete possible variation range of all intrinsic parameters. Therefore, in certain cases a deviation from the provided data could occur.

LEDiL Oy reserves the right to undertake technical changes of its products without further notification which could lead to changes in the provided data. LEDiL Oy assumes no liability of any kind for the possible deviation from any provided data or any other damage resulting from the usage of the provided data.

The user agrees to this disclaimer and user agreement with the download or usage of the provided files.

LEDiL Oy

Joensuunkatu 7
FI-24240 SALO
Finland

LEDiL Inc.

228 West Page Street
Suite D
Sycamore IL 60178
USA

Ledil Optics Technology (Shenzhen) Co., Ltd.

405 , Block B
Casic Motor Building
Shenzhen 518057
P.R.CHINA

Local sales and technical support

[www.ledil.com/
where_to_buy](http://www.ledil.com/where_to_buy)

Shipping locations

Poznan, Poland
Hong Kong, China

Distribution Partners

[www.ledil.com/
where_to_buy](http://www.ledil.com/where_to_buy)