

FLORENCE-1R-Z90

~90° + 110° wide beam

SPECIFICATION:

Dimensions	19.5 x 286.0 mm
Height	7 mm
Fastening	clips
ROHS compliant	yes ⓘ

MATERIALS:

Component	Type	Material	Colour	Finish	Length
FLORENCE-1R-Z90	Linear lens	PMMA	clear		19.5

ORDERING INFORMATION:

Component	Qty in box	MOQ	MPQ	Box weight (kg)
F14304_FLORENCE-1R-Z90 » Box size: 398 x 298 x 265 mm	165	45	15	7.5

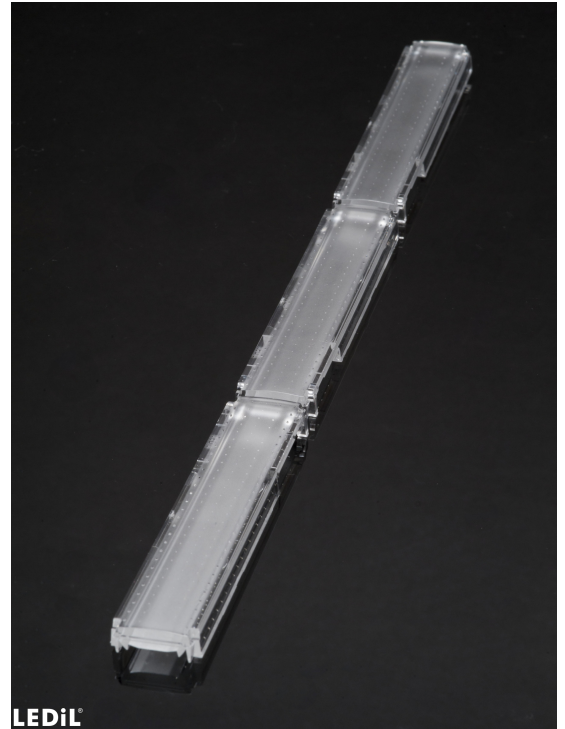

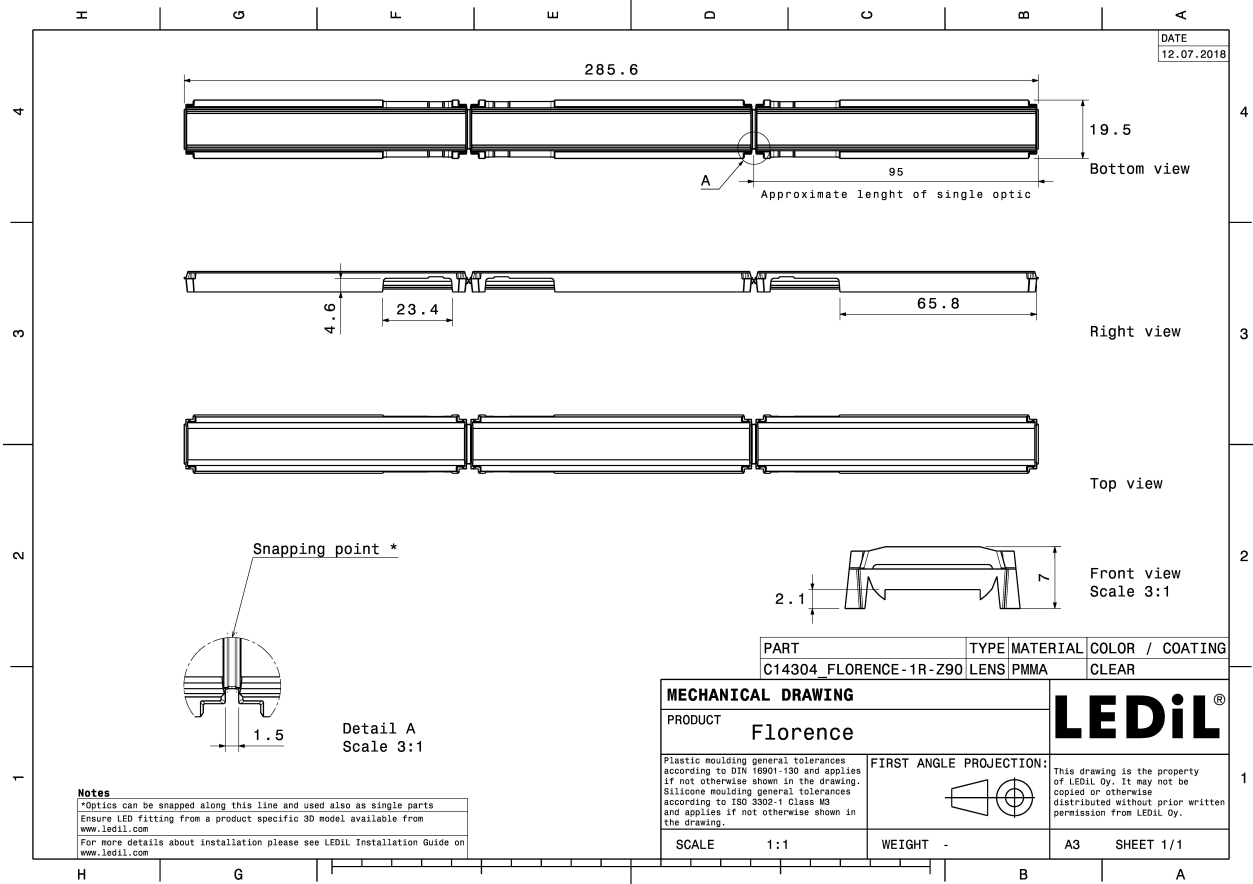

See also our general installation guide: www.ledil.com/installation_guide

OPTICAL RESULTS (MEASURED):



LED CALGD0414-M8W1
 FWHM / FWTM 89.0 + 115.0° / 151.0 + 159.0°
 Efficiency 93 %
 Peak intensity 0.4 cd/lm
 LEDs/each optic 1
 Light colour/type White
 Required components:

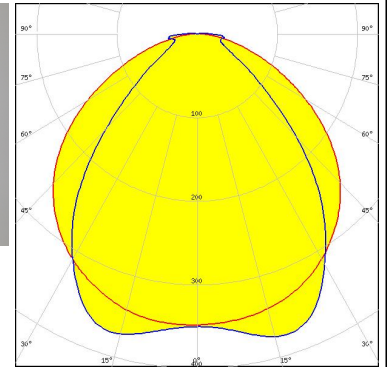

Light distribution files



LED CALGD0814-M17W1
 FWHM / FWTM 90.0 + 114.0° / 137.0 + 159.0°
 Efficiency 93 %
 Peak intensity 0.4 cd/lm
 LEDs/each optic 1
 Light colour/type White
 Required components:

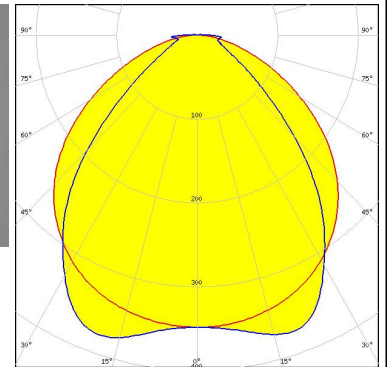

Light distribution files



LED L0-280024-xxx-C0800-L267
 FWHM / FWTM 88.0 + 106.0° / 131.0 + 156.0°
 Efficiency 92 %
 Peak intensity 0.4 cd/lm
 LEDs/each optic 1
 Light colour/type White
 Required components:

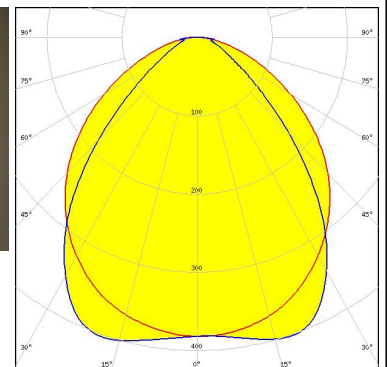
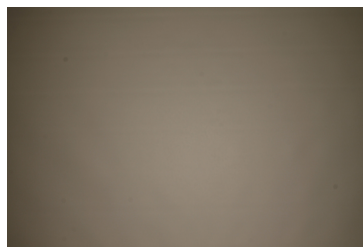

Light distribution files

OPTICAL RESULTS (MEASURED):



LED XH-B/G
 FWHM / FWTM 97.0 + 117.0° / 139.0 + 165.0°
 Efficiency 90 %
 Peak intensity 0.4 cd/lm
 LEDs/each optic 1
 Light colour/type White
 Required components:

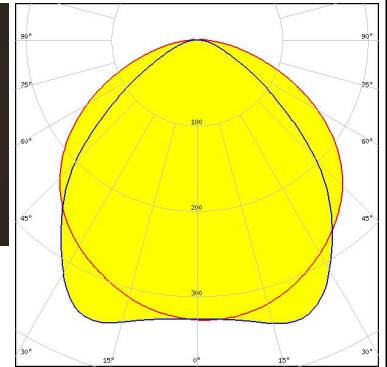
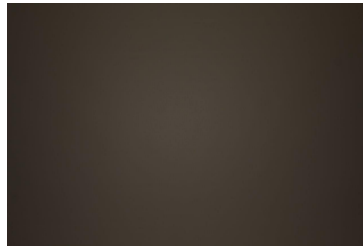

Light distribution files



LED LUXEON 3014
 FWHM / FWTM 91.0 + 109.0° / 125.0 + 156.0°
 Efficiency 94 %
 Peak intensity 0.4 cd/lm
 LEDs/each optic 1
 Light colour/type White
 Required components:

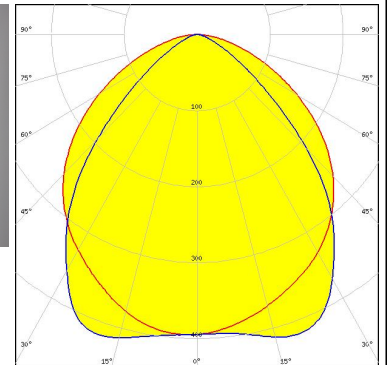

Light distribution files



LED LUXEON 3020
 FWHM / FWTM 89.0 + 108.0° / 123.0 + 157.0°
 Efficiency 94 %
 Peak intensity 0.4 cd/lm
 LEDs/each optic 1
 Light colour/type White
 Required components:

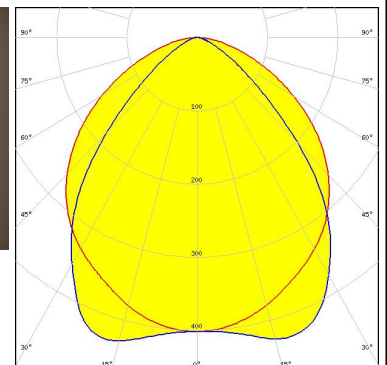
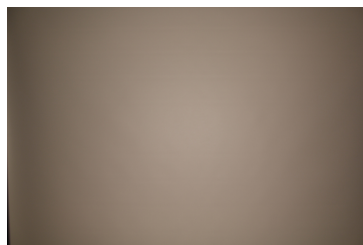

Light distribution files

OPTICAL RESULTS (MEASURED):



LED LUXEON 3030 2D (Round LES)
FWHM / FWTM 88.0 + 108.0° / 125.0 + 157.0°
Efficiency 92 %
Peak intensity 0.4 cd/lm
LEDs/each optic 1
Light colour/type White
Required components:

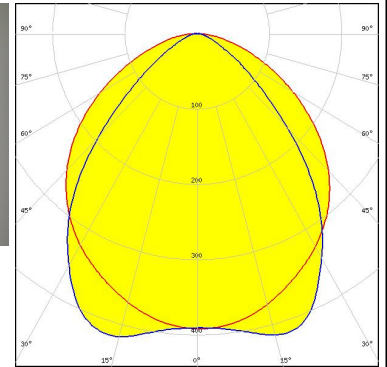
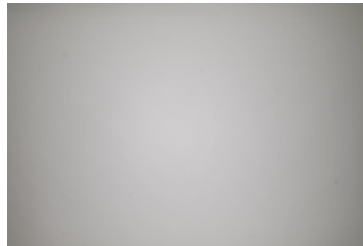

Light distribution files



LED LUXEON 3535 2D
FWHM / FWTM 92.0 + 110.0° / 133.0 + 160.0°
Efficiency 93 %
Peak intensity 0.4 cd/lm
LEDs/each optic 1
Light colour/type White
Required components:

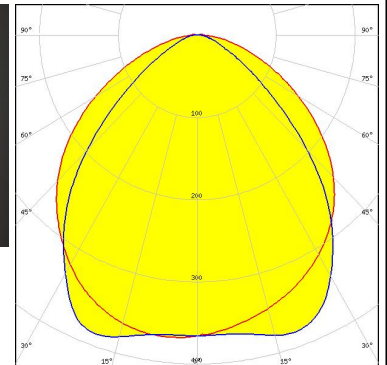
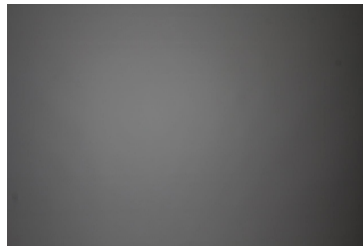

Light distribution files



LED LUXEON 3535L
FWHM / FWTM 92.0 + 109.0° / 128.0 + 157.0°
Efficiency 94 %
Peak intensity 0.4 cd/lm
LEDs/each optic 1
Light colour/type White
Required components:

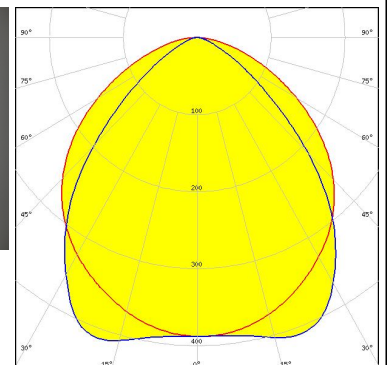

Light distribution files

OPTICAL RESULTS (MEASURED):



LED MP-2016
FWHM / FWTM 89.0 + 108.0° / 125.0 + 157.0°
Efficiency 93 %
Peak intensity 0.4 cd/lm
LEDs/each optic 1
Light colour/type White
Required components:

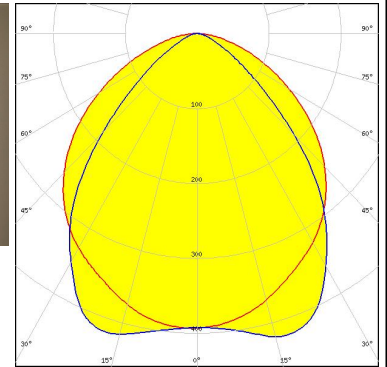
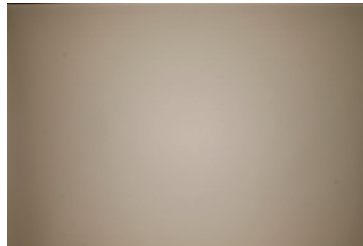

Light distribution files



LED NF2x757D
FWHM / FWTM 90.0 + 110.0° / 131.0 + 160.0°
Efficiency 93 %
Peak intensity 0.4 cd/lm
LEDs/each optic 1
Light colour/type White
Required components:

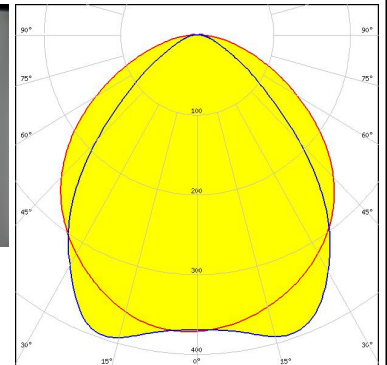

Light distribution files



LED NF2x757G
FWHM / FWTM 90.0 + 108.0° / 127.0 + 158.0°
Efficiency 92 %
Peak intensity 0.4 cd/lm
LEDs/each optic 1
Light colour/type White
Required components:

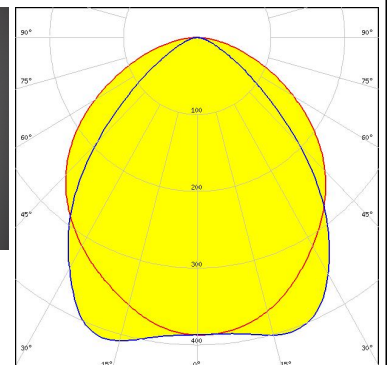
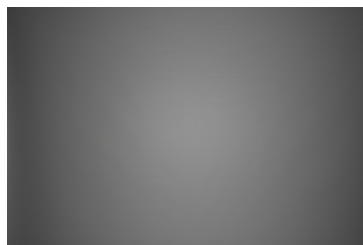

Light distribution files

OPTICAL RESULTS (MEASURED):



LED NFSW757H
FWHM / FWTM 104.0 + 89.0° / 156.0 + 140.0°
Efficiency 94 %
Peak intensity 0.4 cd/lm
LEDs/each optic 1
Light colour/type White
Required components:
 C14353_FLORENCE-1R-CLIP-A

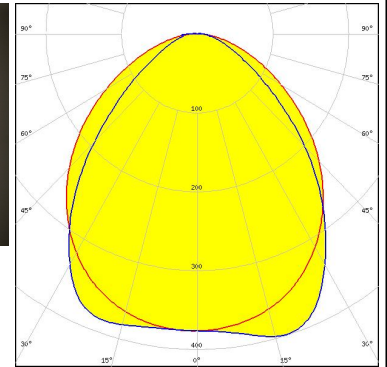

Light distribution files



LED Duris S5 (2 chip)
FWHM / FWTM 90.0 + 113.0° / 131.0 + 161.0°
Efficiency 94 %
Peak intensity 0.4 cd/lm
LEDs/each optic 1
Light colour/type White
Required components:

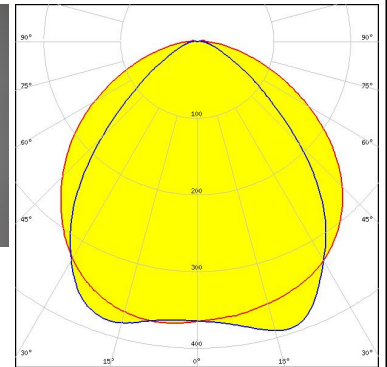

Light distribution files



LED Fortimo LED Line 1ft HF 1R HV5
FWHM / FWTM 113.0 + 90.0° / 157.0 + 122.0°
Efficiency 96 %
Peak intensity 0.4 cd/lm
LEDs/each optic 1
Light colour/type White
Required components:
 C14353_FLORENCE-1R-CLIP-A

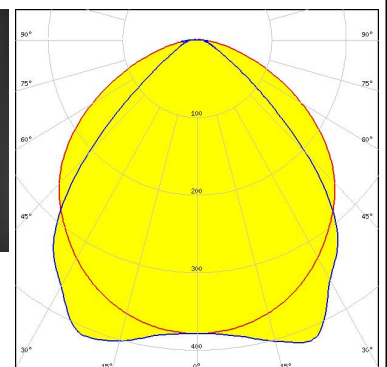
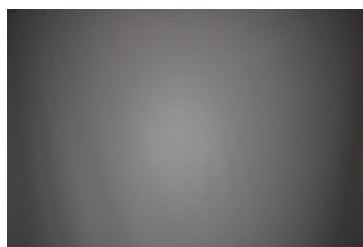

Light distribution files

OPTICAL RESULTS (MEASURED):

PHILIPS

LED Fortimo LED Line 1ft MF 1R HV5 & LV5
 FWHM / FWTM 113.0 + 91.0° / 157.0 + 122.0°
 Efficiency 96 %
 Peak intensity 0.4 cd/lm
 LEDs/each optic 1
 Light colour/type White
 Required components:
 C14353_FLORENCE-1R-CLIP-A

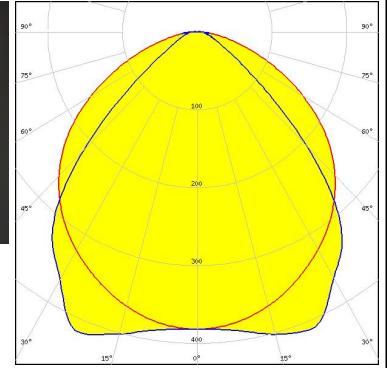
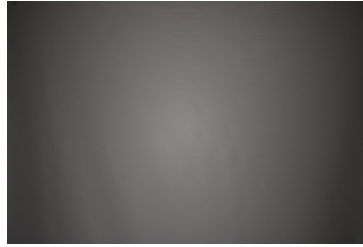

Light distribution files

SAMSUNG

LED LM28xB Series
 FWHM / FWTM 91.0 + 111.0° / 127.0 + 158.0°
 Efficiency 94 %
 Peak intensity 0.4 cd/lm
 LEDs/each optic 1
 Light colour/type White
 Required components:

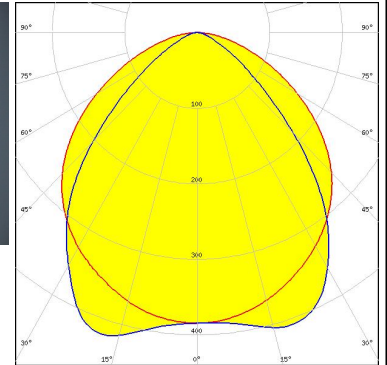
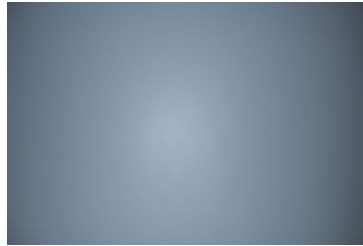

Light distribution files

SAMSUNG

LED LM301A
 FWHM / FWTM 89.0 + 109.0° / 125.0 + 158.0°
 Efficiency 94 %
 Peak intensity 0.4 cd/lm
 LEDs/each optic 1
 Light colour/type White
 Required components:

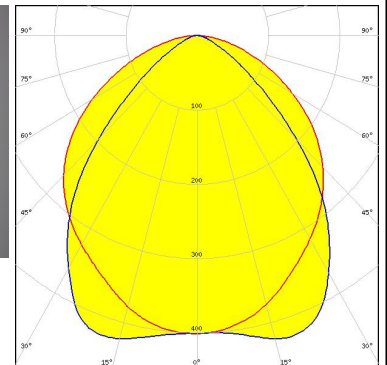
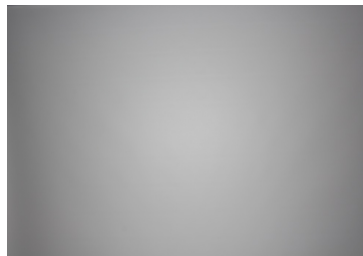

Light distribution files

OPTICAL RESULTS (MEASURED):

SAMSUNG

LED LM302A
FWHM / FWTM 90.0 + 108.0° / 128.0 + 159.0°
Efficiency 93 %
Peak intensity 0.4 cd/lm
LEDs/each optic 1
Light colour/type White
Required components:

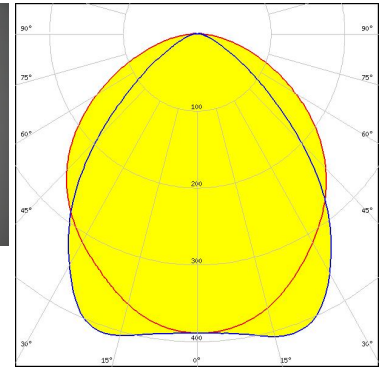
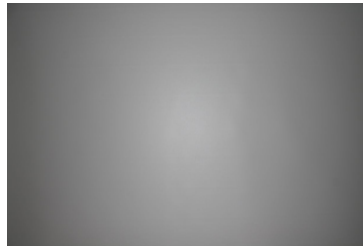

Light distribution files

SAMSUNG

LED LM561B
FWHM / FWTM 91.0 + 109.0° / 131.0 + 159.0°
Efficiency 93 %
Peak intensity 0.4 cd/lm
LEDs/each optic 1
Light colour/type White
Required components:

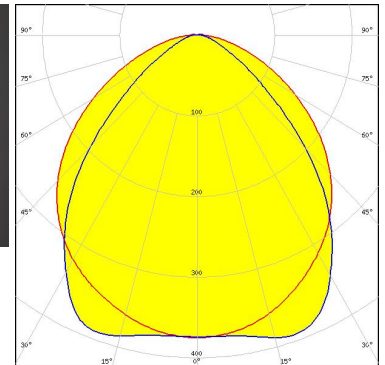
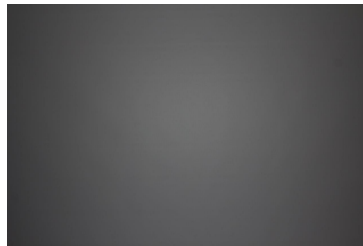

Light distribution files

SAMSUNG

LED LM561C
FWHM / FWTM 90.0 + 110.0° / 126.0 + 157.0°
Efficiency 94 %
Peak intensity 0.4 cd/lm
LEDs/each optic 1
Light colour/type White
Required components:

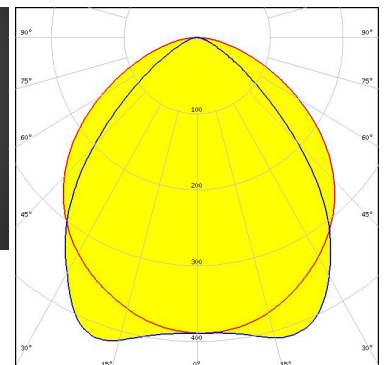
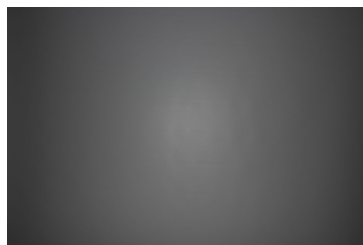

Light distribution files

OPTICAL RESULTS (MEASURED):

SAMSUNG

LED LT-S282N
 FWHM / FWTM 91.0 + 109.0° / 156.0 + 131.0°
 Efficiency 94 %
 Peak intensity 0.4 cd/lm
 LEDs/each optic 1
 Light colour/type White
 Required components:

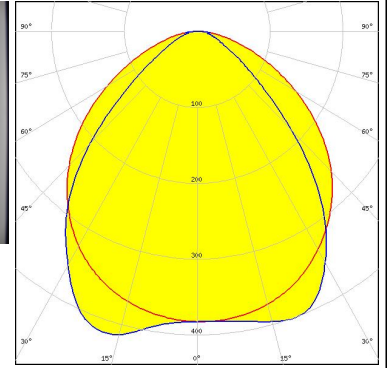

Light distribution files



LED SEOUL 3030
 FWHM / FWTM 90.0 + 109.0° / 127.0 + 158.0°
 Efficiency 92 %
 Peak intensity 0.4 cd/lm
 LEDs/each optic 1
 Light colour/type White
 Required components:

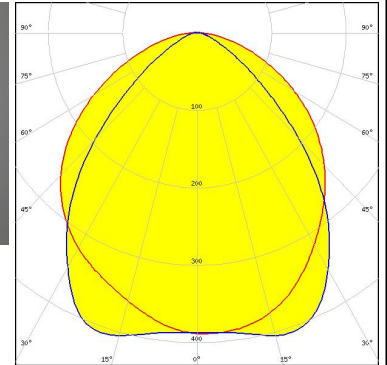

Light distribution files



LED SEOUL DC 3030
 FWHM / FWTM 103.0 + 86.0° / 156.0 + 151.0°
 Efficiency 94 %
 Peak intensity 0.4 cd/lm
 LEDs/each optic 1
 Light colour/type White
 Required components:
 C14353_FLORENCE-1R-CLIP-A

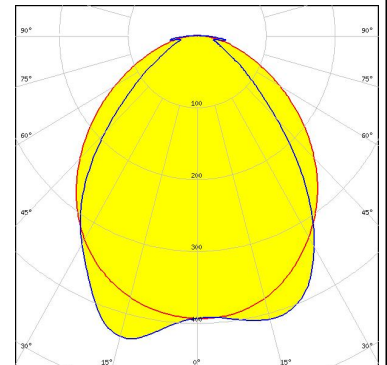

Light distribution files

OPTICAL RESULTS (SIMULATED):



LED LUXEON 2835 Line
FWHM / FWTM 90.0 + 111.0° / 114.0 + 152.0°
Efficiency 93 %
Peak intensity 0.4 cd/lm
LEDs/each optic 1
Light colour/type White
Required components:

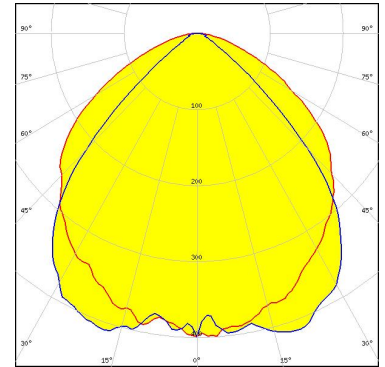

Light distribution files



LED LUXEON 5050 Round LES
FWHM / FWTM 91.0 + 111.0° / 120.0 + 153.0°
Efficiency 94 %
Peak intensity 0.4 cd/lm
LEDs/each optic 1
Light colour/type White
Required components:

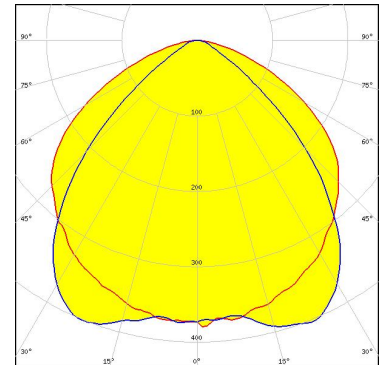

Light distribution files



LED Duris E 2835
FWHM / FWTM 94.0 + 106.0° / 120.0 + 150.0°
Efficiency 93 %
Peak intensity 0.4 cd/lm
LEDs/each optic 1
Light colour/type White
Required components:

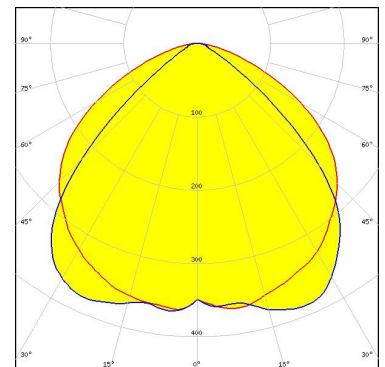

Light distribution files

OPTICAL RESULTS (SIMULATED):

OSRAM
Opto Semiconductors

LED OSCONIQ C 2424
FWHM / FWTM 117.0 + 96.0° / 152.0 + 106.0°
Efficiency 94 %
Peak intensity 0.4 cd/lm
LEDs/each optic 1
Light colour/type White
Required components:

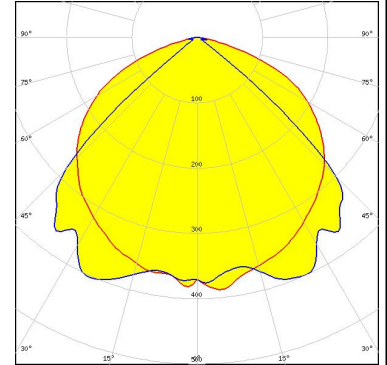

Light distribution files

SEOUL
SEMICONDUCTOR

LED SEOUL DC 3030C
FWHM / FWTM 112.0 + 94.0° / 154.0 + 119.0°
Efficiency 93 %
Peak intensity 0.4 cd/lm
LEDs/each optic 1
Light colour/type White
Required components:

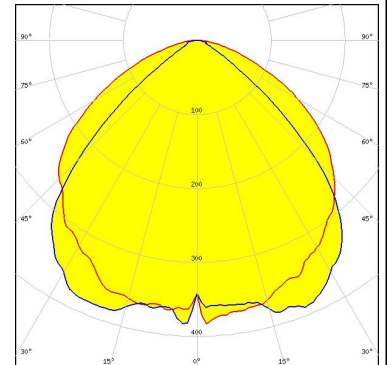

Light distribution files

GENERAL INFORMATION:

NOTE: The typical beam angle will be changed by different color, chip size and chip position tolerance. The typical total beam angle is the full angle measured where the luminous intensity is half of the peak value.

MATERIALS:

As part of our continuous research and improvement processes, and to ensure the best possible quality and availability of our products, LEDiL reserves the right to change material grades without notice.

PRODUCT DATA USER AGREEMENT AND DISCLAIMER:

The measured data in the provided downloadable LEDiL Product Datasheets and Mechanical 2D-Drawings is rounded and provided as reference for planning. LEDiL Oy's optical specifications have been verified by conducting performance testing of the products in accordance with the company's quality system. The reported data are averaged results of multiple measurements with typical variation. LEDiL Oy reserves the right to without prior notification make changes and improvements to its products.

LEDiL Oy assumes neither warranty, nor guarantee nor any other liability of any kind for the contents and correctness of the provided data. The provided data has been generated with highest diligence but the provided data may in reality not represent the complete possible variation range of all intrinsic parameters. Therefore, in certain cases a deviation from the provided data could occur.

LEDiL Oy reserves the right to undertake technical changes of its products without further notification which could lead to changes in the provided data. LEDiL Oy assumes no liability of any kind for the possible deviation from any provided data or any other damage resulting from the usage of the provided data.

The user agrees to this disclaimer and user agreement with the download or usage of the provided files.

LEDiL Oy

Joensuunkatu 13
FI-24240 SALO
Finland

LEDiL Inc.

228 West Page Street
Suite D
Sycamore IL 60178
USA

Ledil Optics Technology (Shenzhen) Co., Ltd.

405 , Block B
Casic Motor Building
Shenzhen 518057
P.R.CHINA

Local sales and technical support

[www.ledil.com/
where_to_buy](http://www.ledil.com/where_to_buy)

Shipping locations

Poznan, Poland
Hong Kong, China

Distribution Partners

[www.ledil.com/
where_to_buy](http://www.ledil.com/where_to_buy)