

IRIS-M

~25° medium beam with sublens and holder

SPECIFICATION:

Dimensions	Ø 38.0
Height	30 mm
Fastening	glue, screw
ROHS compliant	yes ⓘ

MATERIALS:

Component	Type	Material	Colour	Finish	Length (mm)
C10781_IRIS	Single lens	PMMA	clear		
C10860_IRIS-HLD	Holder	PC	black		
C10333_LEDILSTAR-SUB	Sublens	PC			



ORDERING INFORMATION:

Quantities for one set:

Single lens	1
Holder	1
Sublens	1

Component		Qty in box	MOQ	MPQ	Box weight (kg)
C10781_IRIS	Single lens	580	116	58	9.0
» Box size: 480 x 280 x 300 mm					
C10860_IRIS-HLD	Holder	1044	116	29	7.2
» Box size: 480 x 280 x 300 mm					
C10333_LEDILSTAR-SUB	Sublens	2500	90	4	4.5
» Box size: 300 x 250 x 250 mm					

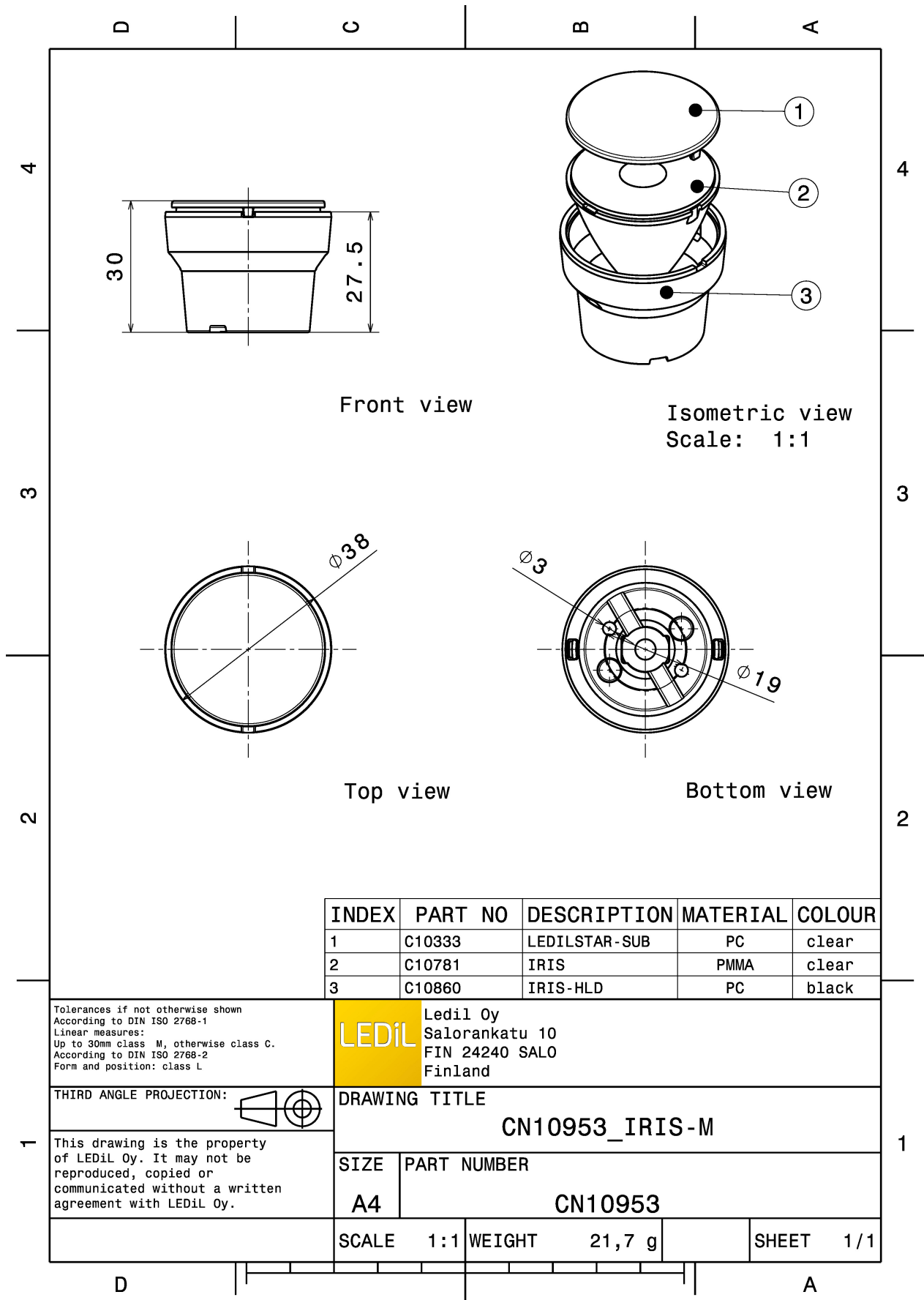

See also our general installation guide: www.ledil.com/installation_guide

OPTICAL RESULTS (MEASURED):



LED MC-E
 FWHM / FWTM 28.0° / 48.0°
 Efficiency 81 %
 Peak intensity 2.9 cd/lm
 LEDs/each optic 1
 Light colour/type White
 Required components:

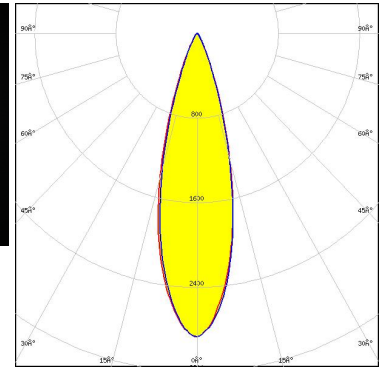
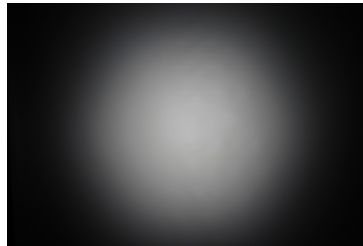

Light distribution files



LED MHD-E/G
 FWHM / FWTM 30.0° / 58.0°
 Efficiency 93 %
 Peak intensity 2.2 cd/lm
 LEDs/each optic 1
 Light colour/type White
 Required components:

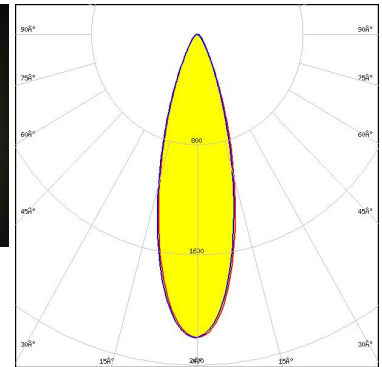
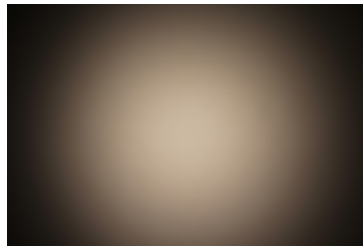

Light distribution files



LED XHP50
 FWHM / FWTM 30.0° / 60.0°
 Efficiency 75 %
 Peak intensity 2 cd/lm
 LEDs/each optic 1
 Light colour/type White
 Required components:

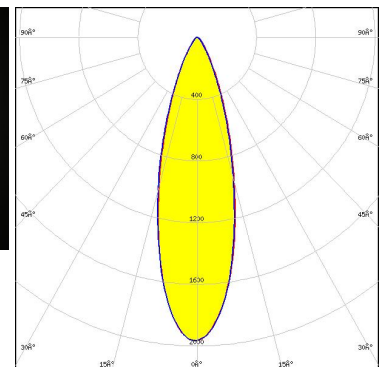
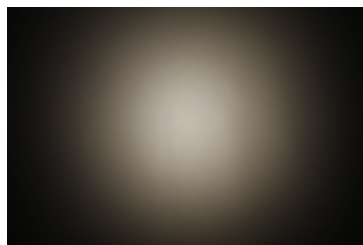

Light distribution files

OPTICAL RESULTS (MEASURED):



LED XHP50.2
FWHM / FWTM 29.0° / 53.0°
Efficiency 77 %
Peak intensity 2.5 cd/lm
LEDs/each optic 1
Light colour/type White
Required components:

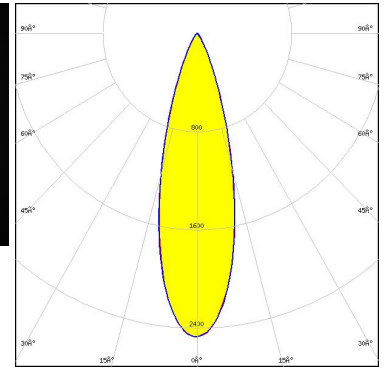
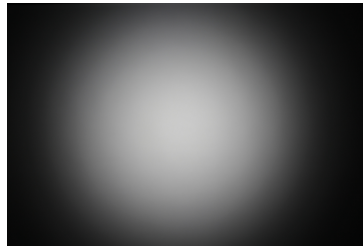

Light distribution files



LED Duris S10
FWHM / FWTM 30.0° / 56.0°
Efficiency 75 %
Peak intensity 2.4 cd/lm
LEDs/each optic 1
Light colour/type White
Required components:

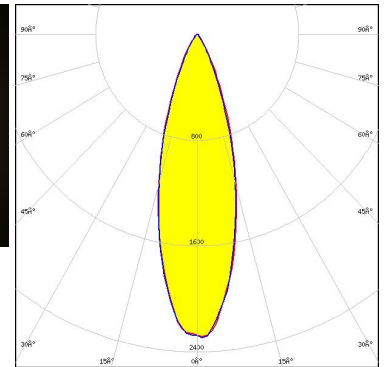
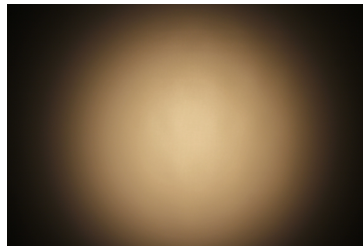

Light distribution files

OPTICAL RESULTS (SIMULATED):



LED J Series 5050B 6V K Class
FWHM / FWTM 16.0° / 30.0°
Efficiency 83 %
Peak intensity 9.1 cd/lm
LEDs/each optic 1
Light colour/type White
Required components:

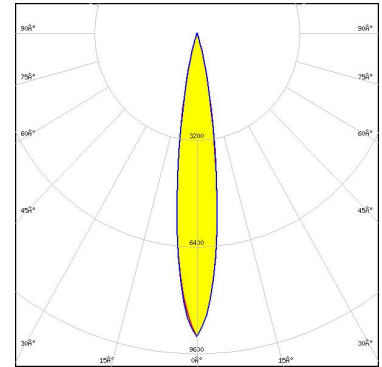

Light distribution files



LED J Series 5050C 6V E Class
FWHM / FWTM 16.0° / 28.0°
Efficiency 82 %
Peak intensity 9.4 cd/lm
LEDs/each optic 1
Light colour/type White
Required components:

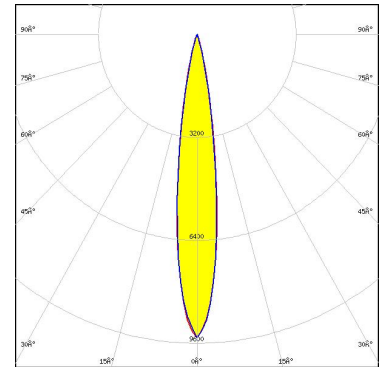

Light distribution files



LED XD16
FWHM / FWTM 12.0° / 24.0°
Efficiency 76 %
Peak intensity 13.1 cd/lm
LEDs/each optic 1
Light colour/type White
Required components:

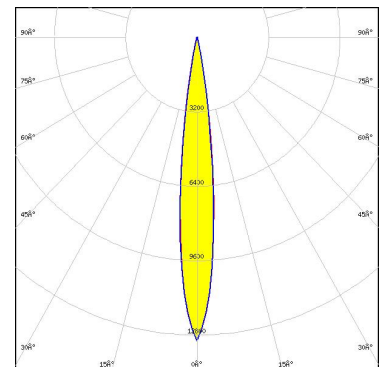

Light distribution files

OPTICAL RESULTS (SIMULATED):



LED XHP35 HD
 FWHM / FWTM 14.0° / 28.0°
 Efficiency 84 %
 Peak intensity 10.4 cd/lm
 LEDs/each optic 1
 Light colour/type White
 Required components:

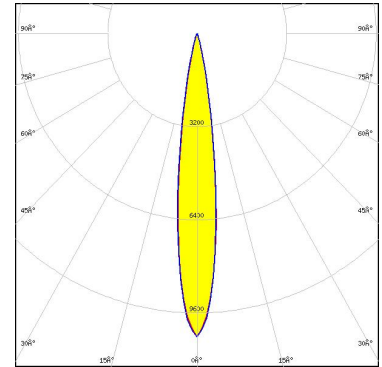

Light distribution files



LED XHP35 HI
 FWHM / FWTM 13.0° / 24.0°
 Efficiency 84 %
 Peak intensity 13.5 cd/lm
 LEDs/each optic 1
 Light colour/type White
 Required components:

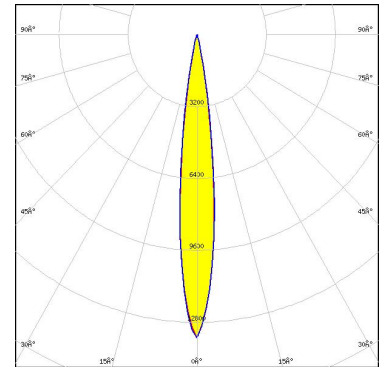

Light distribution files



LED XHP50.3 HD
 FWHM / FWTM 15.0 + 16.0° / 28.0°
 Efficiency 80 %
 Peak intensity 9.5 cd/lm
 LEDs/each optic 1
 Light colour/type White
 Required components:

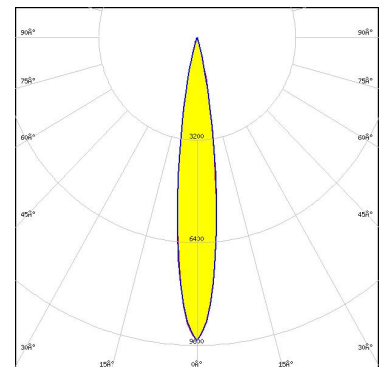

Light distribution files

OPTICAL RESULTS (SIMULATED):



LED XP-G4 HI
 FWHM / FWTM 12.0° / 20.0°
 Efficiency 81 %
 Peak intensity 16.6 cd/lm
 LEDs/each optic 1
 Light colour/type White
 Required components:

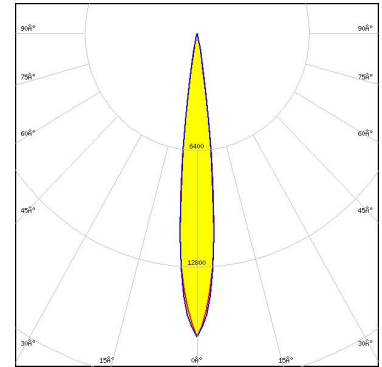

Light distribution files



LED XP-P
 FWHM / FWTM 12.0° / 22.0°
 Efficiency 84 %
 Peak intensity 16.8 cd/lm
 LEDs/each optic 1
 Light colour/type White
 Required components:

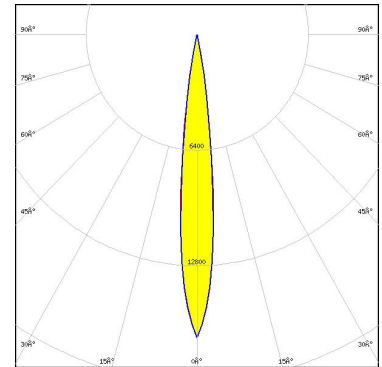

Light distribution files



LED LUXEON 5050 Round LES
 FWHM / FWTM 16.0° / 28.0°
 Efficiency 83 %
 Peak intensity 9.5 cd/lm
 LEDs/each optic 1
 Light colour/type White
 Required components:

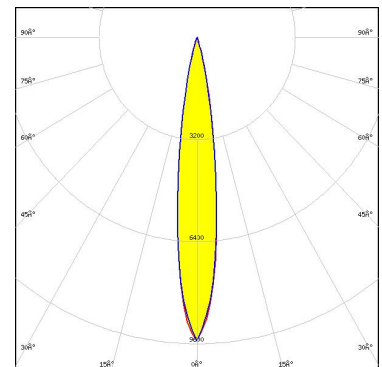

Light distribution files

OPTICAL RESULTS (SIMULATED):



LED LUXEON 7070
FWHM / FWTM 20.0° / 38.0°
Efficiency 80 %
Peak intensity 5.3 cd/lm
LEDs/each optic 1
Light colour/type White
Required components:

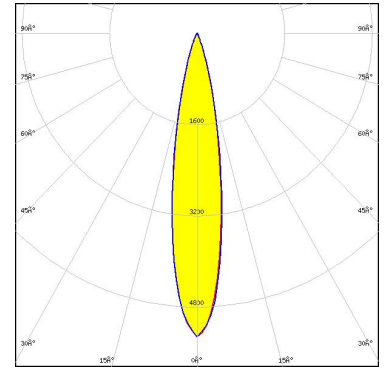

Light distribution files



LED LUXEON M/MX
FWHM / FWTM 18.0° / 32.0°
Efficiency 82 %
Peak intensity 7.5 cd/lm
LEDs/each optic 1
Light colour/type White
Required components:

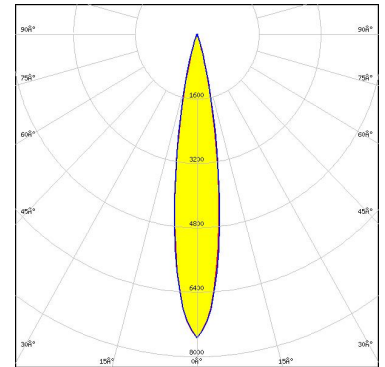

Light distribution files



LED SST-20 Gen1
FWHM / FWTM 14.0° / 24.0°
Efficiency 82 %
Peak intensity 13.5 cd/lm
LEDs/each optic 1
Light colour/type White
Required components:

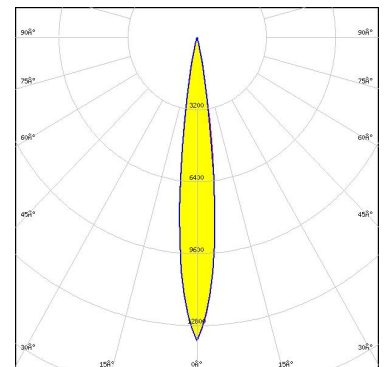

Light distribution files

OPTICAL RESULTS (SIMULATED):

OSRAM
Opto Semiconductors

LED	OSLON Square Flat
FWHM / FWTM	15.0° / 30.0°
Efficiency	80 %
Peak intensity	8.7 cd/lm
LEDs/each optic	1
Light colour/type	White
Required components:	

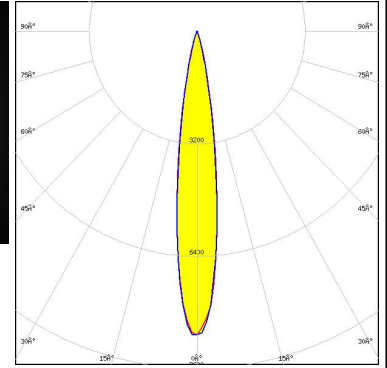

Light distribution files

GENERAL INFORMATION:

NOTE: The typical beam angle will be changed by different color, chip size and chip position tolerance. The typical total beam angle is the full angle measured where the luminous intensity is half of the peak value.

MATERIALS:

As part of our continuous research and improvement processes, and to ensure the best possible quality and availability of our products, LEDiL reserves the right to change material grades without notice.

PRODUCT DATA USER AGREEMENT AND DISCLAIMER:

The measured data in the provided downloadable LEDiL Product Datasheets and Mechanical 2D-Drawings is rounded and provided as reference for planning. LEDiL Oy's optical specifications have been verified by conducting performance testing of the products in accordance with the company's quality system. The reported data are averaged results of multiple measurements with typical variation. LEDiL Oy reserves the right to without prior notification make changes and improvements to its products.

LEDiL Oy assumes neither warranty, nor guarantee nor any other liability of any kind for the contents and correctness of the provided data. The provided data has been generated with highest diligence but the provided data may in reality not represent the complete possible variation range of all intrinsic parameters. Therefore, in certain cases a deviation from the provided data could occur.

LEDiL Oy reserves the right to undertake technical changes of its products without further notification which could lead to changes in the provided data. LEDiL Oy assumes no liability of any kind for the possible deviation from any provided data or any other damage resulting from the usage of the provided data.

The user agrees to this disclaimer and user agreement with the download or usage of the provided files.

LEDiL Oy

Joensuunkatu 7
FI-24240 SALO
Finland

LEDiL Inc.

228 West Page Street
Suite D
Sycamore IL 60178
USA

Ledil Optics Technology (Shenzhen) Co., Ltd.

405 , Block B
Casic Motor Building
Shenzhen 518057
P.R.CHINA

Local sales and technical support

[www.ledil.com/
where_to_buy](http://www.ledil.com/where_to_buy)

Shipping locations

Poznan, Poland
Hong Kong, China

Distribution Partners

[www.ledil.com/
where_to_buy](http://www.ledil.com/where_to_buy)