

### IRIS-SCREW

~5° real spot beam with holder optimized for CREE XP-E. Assembly with screws.

#### SPECIFICATION:

Dimensions	Ø 38.0
Height	26.9 mm
Fastening	glue, pin, screw
ROHS compliant	yes ⓘ



#### MATERIALS:

Component	Type	Material	Colour	Finish	Length (mm)
F12075_IRIS	Single lens	PMMA	clear		
C12202_IRIS-XP-HLD	Holder	PC	black		

#### ORDERING INFORMATION:

##### Quantities for one set:

Single lens	1
Holder	1

Component		Qty in box	MOQ	MPQ	Box weight (kg)
F12075_IRIS	Single lens	450	90	45	7.5
» Box size: 480 x 280 x 300 mm					
C12202_IRIS-XP-HLD	Holder	1080	90	15	7.6
» Box size: 480 x 280 x 300 mm					

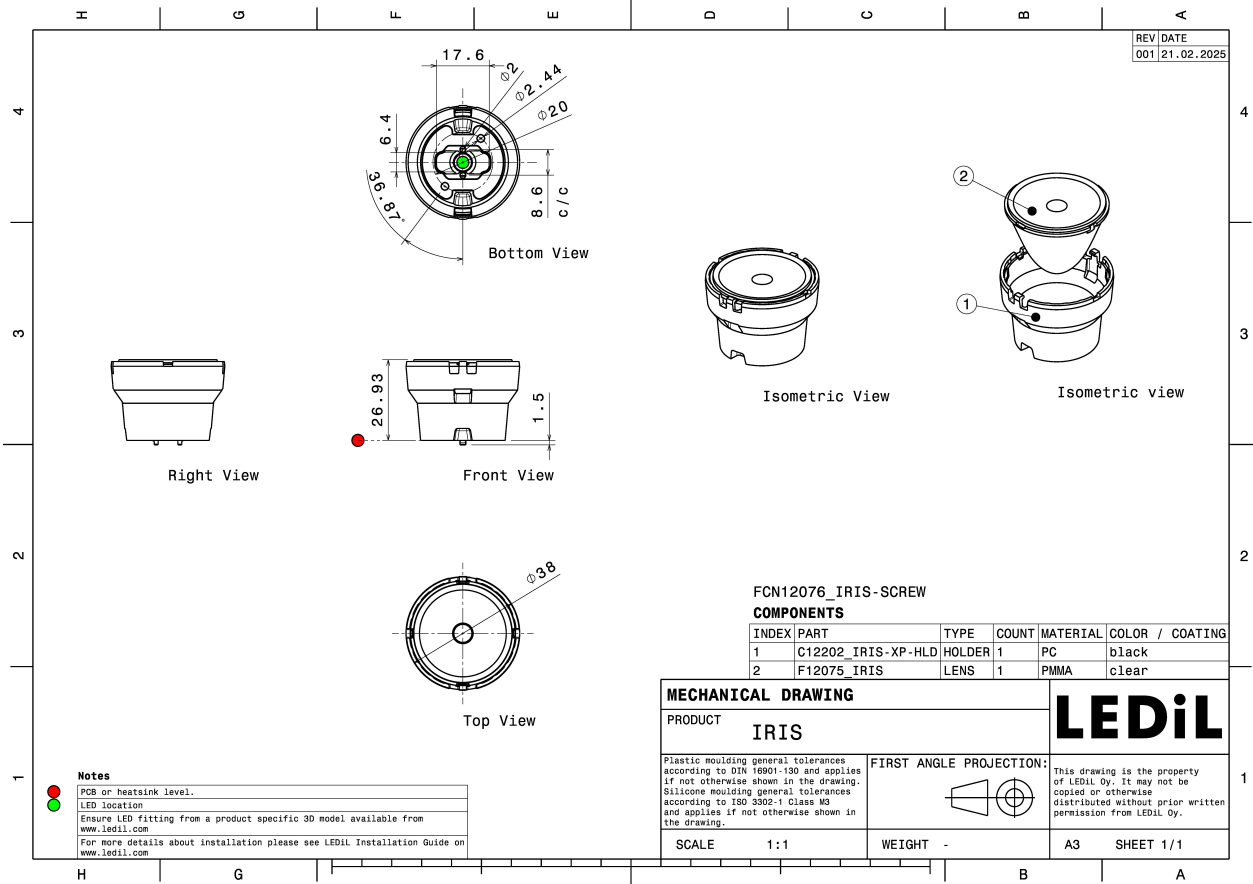

See also our general installation guide: [www.ledil.com/installation\\_guide](http://www.ledil.com/installation_guide)

### OPTICAL RESULTS (MEASURED):



LED XHP35 HI  
FWHM / FWTM 7.6° / 17.0°  
Efficiency 90 %  
Peak intensity 35.9 cd/lm  
LEDs/each optic 1  
Light colour/type White  
Required components:

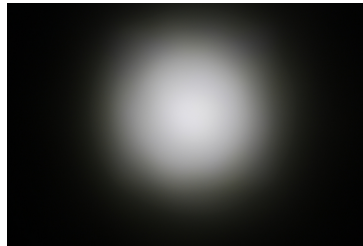

Light distribution files



LED XP-E  
FWHM / FWTM 4.0° / 9.0°  
Efficiency 93 %  
Peak intensity 87.4 cd/lm  
LEDs/each optic 1  
Light colour/type White  
Required components:

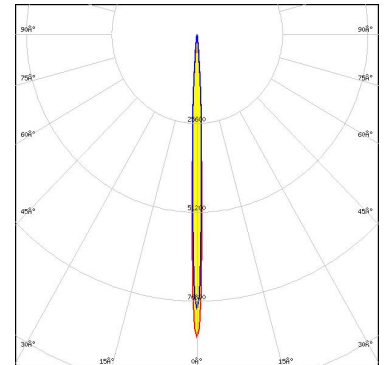

Light distribution files



LED XP-G  
FWHM / FWTM 5.0° / 13.0°  
Efficiency 93 %  
Peak intensity 52 cd/lm  
LEDs/each optic 1  
Light colour/type White  
Required components:

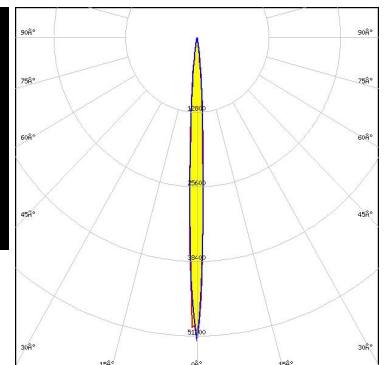
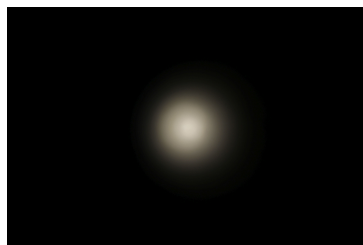

Light distribution files

### OPTICAL RESULTS (MEASURED):



LED XP-L HD  
 FWHM / FWTM 8.5° / 20.0°  
 Efficiency 93 %  
 Peak intensity 22.2 cd/lm  
 LEDs/each optic 1  
 Light colour/type White  
 Required components:

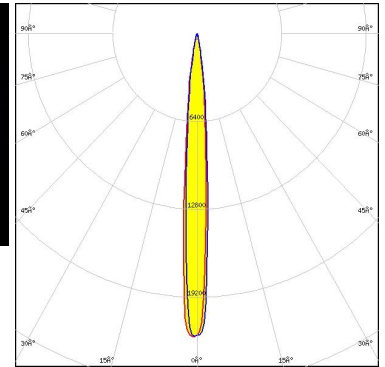

Light distribution files



LED LUXEON Rebel  
 FWHM / FWTM 5.0° / 9.0°  
 Efficiency 93 %  
 Peak intensity 75.6 cd/lm  
 LEDs/each optic 1  
 Light colour/type White  
 Required components:

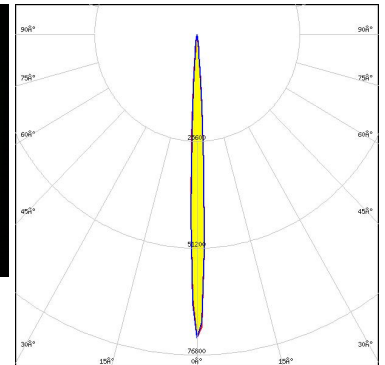

Light distribution files



LED LUXEON Rebel ES  
 FWHM / FWTM 7.0° / 14.0°  
 Efficiency 93 %  
 Peak intensity 38.5 cd/lm  
 LEDs/each optic 1  
 Light colour/type White  
 Required components:

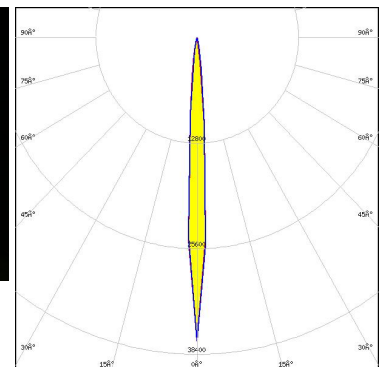

Light distribution files

### OPTICAL RESULTS (MEASURED):



LED LUXEON V  
 FWHM / FWTM 9.0° / 20.0°  
 Efficiency 92 %  
 Peak intensity 20.6 cd/lm  
 LEDs/each optic 1  
 Light colour/type White  
 Required components:

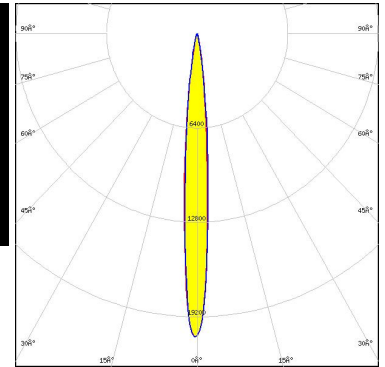
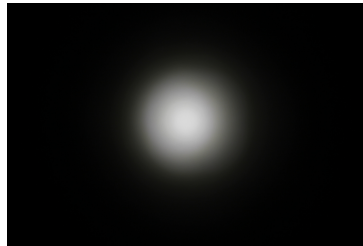

Light distribution files



LED NCSxx19A  
 FWHM / FWTM 5.0° / 11.0°  
 Efficiency %  
 LEDs/each optic 1  
 Light colour/type White  
 Required components:

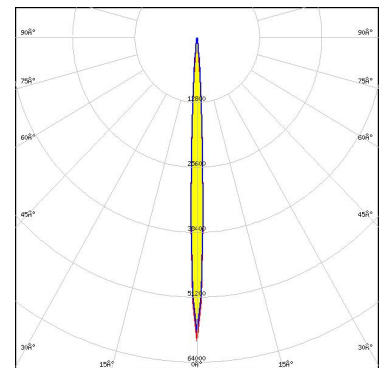

Light distribution files



LED NVSW219F  
 FWHM / FWTM 7.0° / 17.0°  
 Efficiency 93 %  
 Peak intensity 34.8 cd/lm  
 LEDs/each optic 1  
 Light colour/type White  
 Required components:

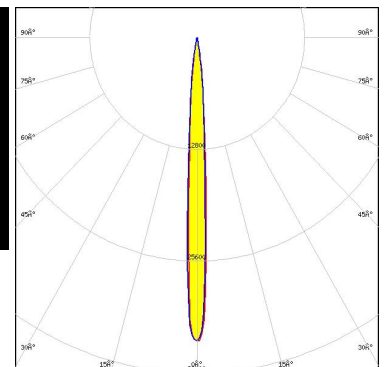

Light distribution files

### OPTICAL RESULTS (MEASURED):



LED NVSW3x9A  
 FWHM / FWTM 8.0° / 18.0°  
 Efficiency 90 %  
 Peak intensity 26.1 cd/lm  
 LEDs/each optic 1  
 Light colour/type White  
 Required components:

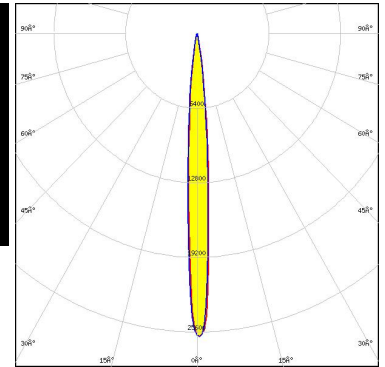
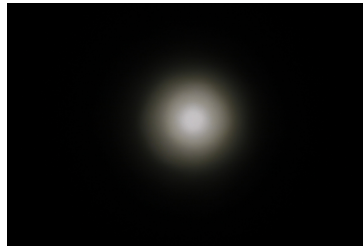

Light distribution files



LED NVSxx19A  
 FWHM / FWTM 6.0° / 14.0°  
 Efficiency 93 %  
 Peak intensity 38.7 cd/lm  
 LEDs/each optic 1  
 Light colour/type White  
 Required components:

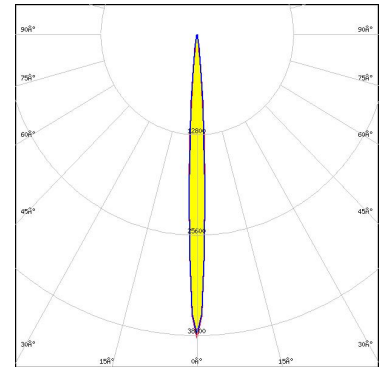

Light distribution files



LED OSLON Square CSSRM2/CSSRM3  
 FWHM / FWTM 6.0° / 13.0°  
 Efficiency 94 %  
 Peak intensity 49.9 cd/lm  
 LEDs/each optic 1  
 Light colour/type White  
 Required components:

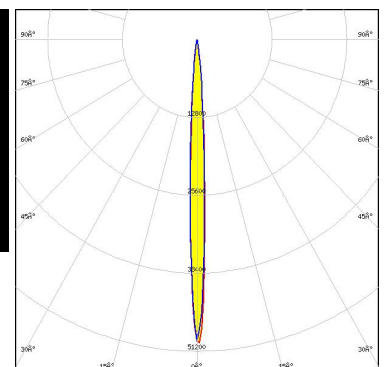
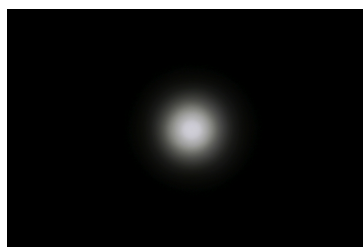

Light distribution files

### OPTICAL RESULTS (MEASURED):

**OSRAM**  
Opto Semiconductors

LED OSLON SSL 150  
FWHM / FWTM 4.0° / 11.0°  
Efficiency 93 %  
Peak intensity 76.8 cd/lm  
LEDs/each optic 1  
Light colour/type White  
Required components:

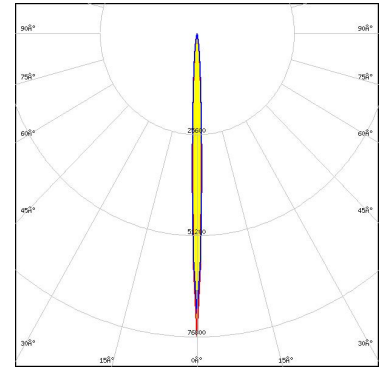

Light distribution files

**OSRAM**  
Opto Semiconductors

LED OSLON SSL 80  
FWHM / FWTM 4.0° / 9.0°  
Efficiency 90 %  
Peak intensity 89 cd/lm  
LEDs/each optic 1  
Light colour/type White  
Required components:

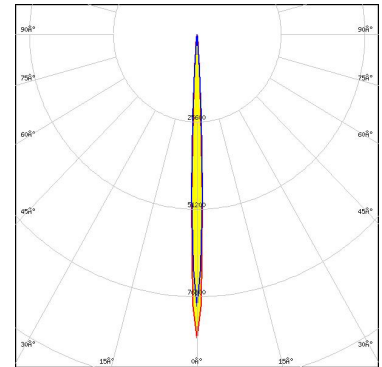

Light distribution files

**SEOL**  
SEOUL SEMICONDUCTOR

LED Z5M3  
FWHM / FWTM 7.0° / 16.0°  
Efficiency 92 %  
Peak intensity 3.1 cd/lm  
LEDs/each optic 1  
Light colour/type White  
Required components:

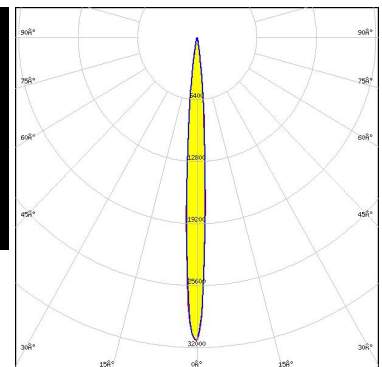
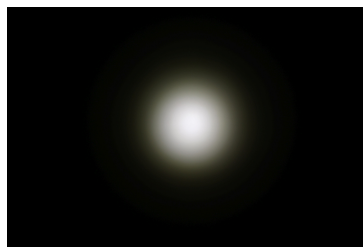

Light distribution files



### OPTICAL RESULTS (SIMULATED):



LED XD16  
 FWHM / FWTM 6.0° / 14.0°  
 Efficiency 91 %  
 Peak intensity 47.1 cd/lm  
 LEDs/each optic 1  
 Light colour/type White  
 Required components:

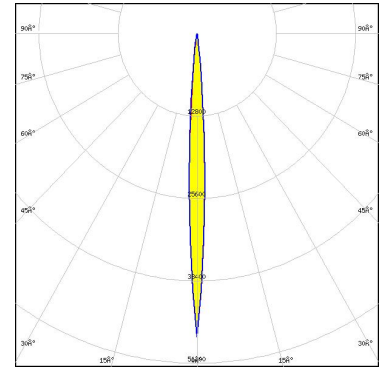

Light distribution files



LED XHP35 HD  
 FWHM / FWTM 10.0° / 22.0°  
 Efficiency 93 %  
 Peak intensity 18.4 cd/lm  
 LEDs/each optic 1  
 Light colour/type White  
 Required components:

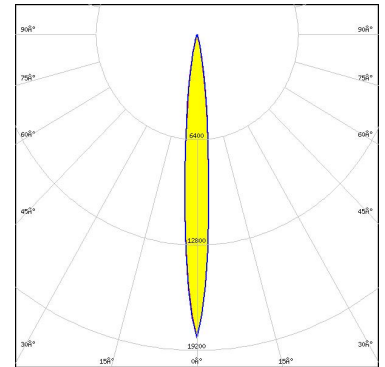

Light distribution files



LED XHP35 HI  
 FWHM / FWTM 8.0° / 18.0°  
 Efficiency 94 %  
 Peak intensity 31.1 cd/lm  
 LEDs/each optic 1  
 Light colour/type White  
 Required components:

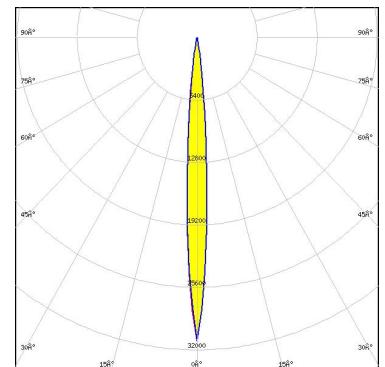

Light distribution files

### OPTICAL RESULTS (SIMULATED):



LED XHP35.2 HD  
 FWHM / FWTM 12.0° / 25.0°  
 Efficiency 86 %  
 Peak intensity 13.5 cd/lm  
 LEDs/each optic 1  
 Light colour/type White  
 Required components:

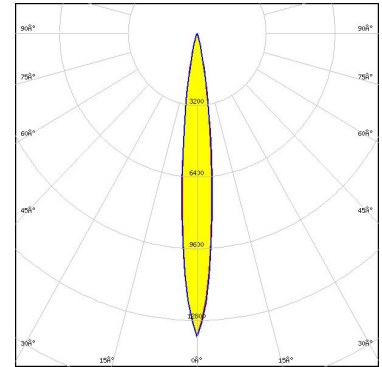

Light distribution files



LED XHP35.2 HD  
 FWHM / FWTM 8.0° / 18.0°  
 Efficiency 90 %  
 Peak intensity 24.4 cd/lm  
 LEDs/each optic 1  
 Light colour/type White  
 Required components:

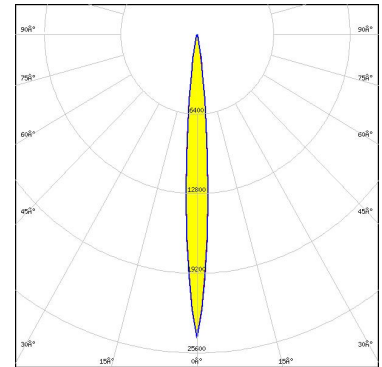

Light distribution files



LED XP-E2  
 FWHM / FWTM 5.9° / 13.0°  
 Efficiency 94 %  
 Peak intensity 56.6 cd/lm  
 LEDs/each optic 1  
 Light colour/type White  
 Required components:

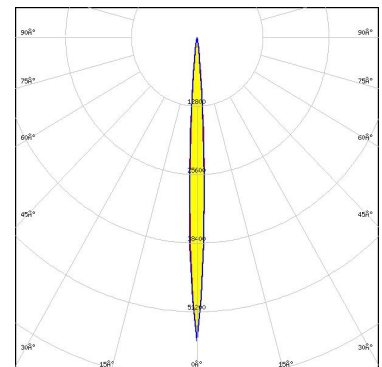

Light distribution files

### OPTICAL RESULTS (SIMULATED):



LED XP-E2  
FWHM / FWTM 6.0° / 12.0°  
Efficiency 93 %  
Peak intensity 67.5 cd/m  
LEDs/each optic 1  
Light colour/type White  
Required components:

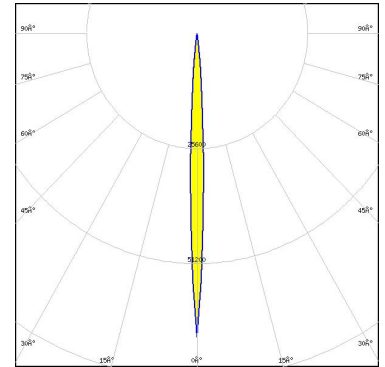

Light distribution files



LED XP-G2  
FWHM / FWTM 6.7° / 15.0°  
Efficiency 94 %  
Peak intensity 44.3 cd/m  
LEDs/each optic 1  
Light colour/type White  
Required components:

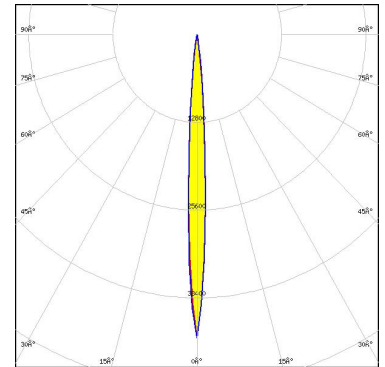

Light distribution files



LED XP-G2 HE  
FWHM / FWTM 8.0° / 18.0°  
Efficiency 90 %  
Peak intensity 28.6 cd/m  
LEDs/each optic 1  
Light colour/type White  
Required components:

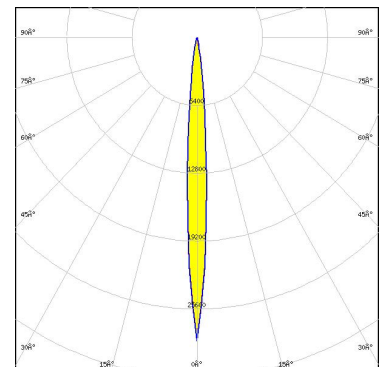

Light distribution files

### OPTICAL RESULTS (SIMULATED):



LED XP-G3  
 FWHM / FWTM 7.5° / 18.0°  
 Efficiency 91 %  
 Peak intensity 29.6 cd/lm  
 LEDs/each optic 1  
 Light colour/type White  
 Required components:

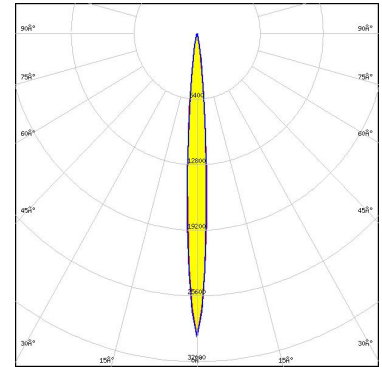

Light distribution files



LED XP-P  
 FWHM / FWTM 3.0° / 8.0°  
 Efficiency 96 %  
 Peak intensity 140.7 cd/lm  
 LEDs/each optic 1  
 Light colour/type White  
 Required components:

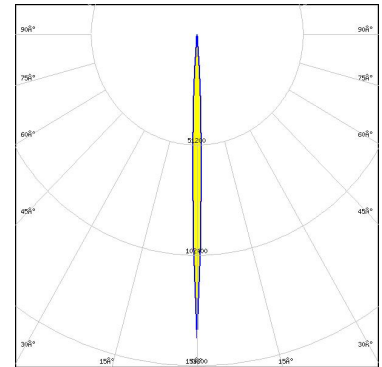

Light distribution files



LED XQ-E HD  
 FWHM / FWTM 5.5° / 12.0°  
 Efficiency 94 %  
 Peak intensity 74.2 cd/lm  
 LEDs/each optic 1  
 Light colour/type White  
 Required components:

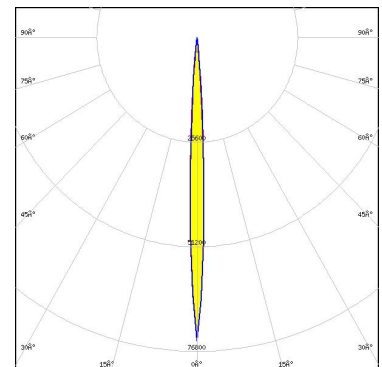

Light distribution files

### OPTICAL RESULTS (SIMULATED):



LED XQ-E HD  
FWHM / FWTM 5.0° / 11.5°  
Efficiency 93 %  
Peak intensity 80 cd/lm  
LEDs/each optic 1  
Light colour/type White  
Required components:

[Light distribution files](#)



LED SST-20 Gen1  
FWHM / FWTM 6.0° / 14.0°  
Efficiency 94 %  
Peak intensity 52.1 cd/lm  
LEDs/each optic 1  
Light colour/type White  
Required components:

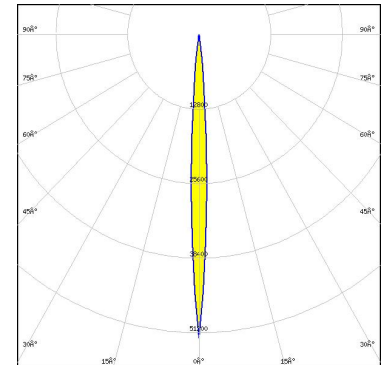

[Light distribution files](#)



LED OSCONIQ P 3737 (2W version)  
FWHM / FWTM 6.5° / 13.0°  
Efficiency 94 %  
Peak intensity 46.4 cd/lm  
LEDs/each optic 1  
Light colour/type White  
Required components:

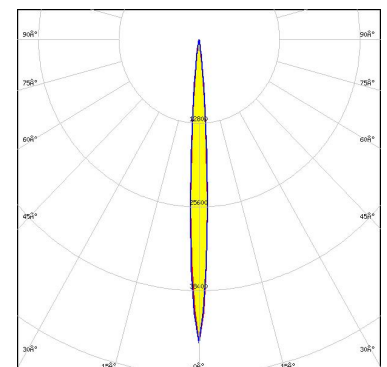

[Light distribution files](#)

### OPTICAL RESULTS (SIMULATED):

**OSRAM**  
Opto Semiconductors

LED OSCONIQ P 3737 (3W version)  
 FWHM / FWTM 9.0° / 19.0°  
 Efficiency 94 %  
 Peak intensity 25.5 cd/m  
 LEDs/each optic 1  
 Light colour/type White  
 Required components:

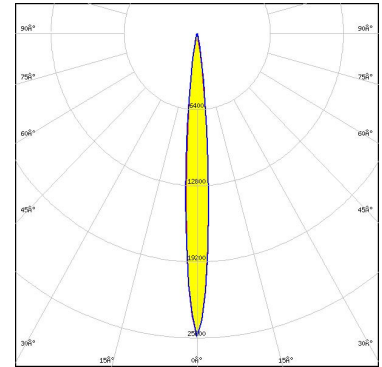

Light distribution files

**OSRAM**  
Opto Semiconductors

LED SFH 4716AS  
 FWHM / FWTM 6.0° / 12.0°  
 Efficiency 94 %  
 LEDs/each optic 1  
 Light colour/type IR  
 Required components:

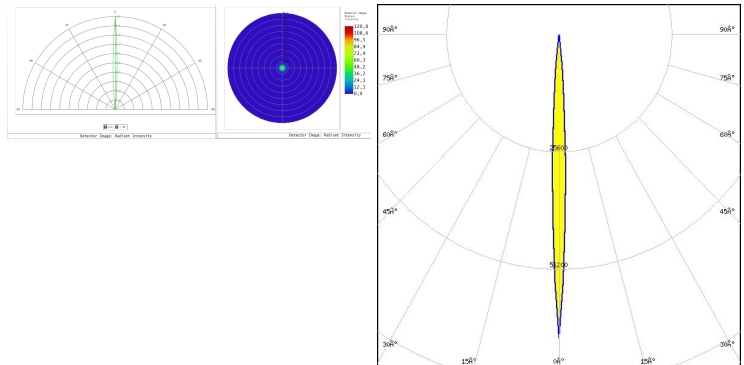

Light distribution files

**SAMSUNG**

LED LH351B  
 FWHM / FWTM 7.4° / 17.0°  
 Efficiency 94 %  
 Peak intensity 33.9 cd/m  
 LEDs/each optic 1  
 Light colour/type White  
 Required components:

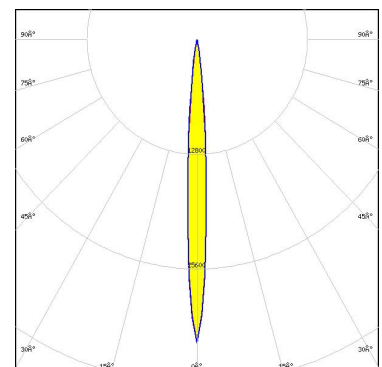

Light distribution files

### OPTICAL RESULTS (SIMULATED):

#### SAMSUNG

LED LH351D  
 FWHM / FWTM 9.2° / 21.0°  
 Efficiency 90 %  
 Peak intensity 20.6 cd/m  
 LEDs/each optic 1  
 Light colour/type White  
 Required components:

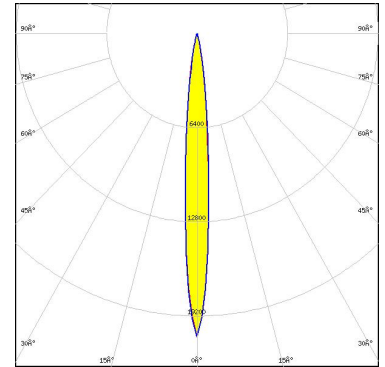

Light distribution files

#### SAMSUNG

LED LM101B  
 FWHM / FWTM 6.0° / 12.0°  
 Efficiency 92 %  
 Peak intensity 58.9 cd/m  
 LEDs/each optic 1  
 Light colour/type White  
 Required components:

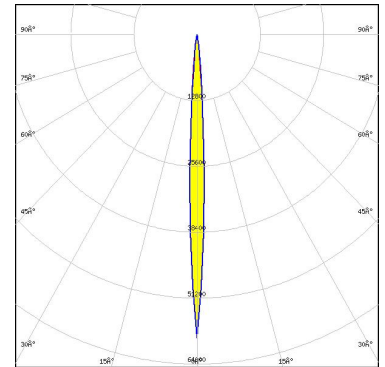

Light distribution files



LED Z8Y22P  
 FWHM / FWTM 8.0°  
 Efficiency 98 %  
 Peak intensity 29.9 cd/m  
 LEDs/each optic 1  
 Light colour/type White  
 Required components:

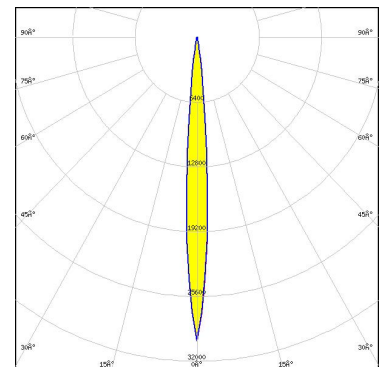

Light distribution files

### GENERAL INFORMATION:

NOTE: The typical beam angle will be changed by different color, chip size and chip position tolerance. The typical total beam angle is the full angle measured where the luminous intensity is half of the peak value.

### MATERIALS:

As part of our continuous research and improvement processes, and to ensure the best possible quality and availability of our products, LEDiL reserves the right to change material grades without notice.

### PRODUCT DATA USER AGREEMENT AND DISCLAIMER:

The measured data in the provided downloadable LEDiL Product Datasheets and Mechanical 2D-Drawings is rounded and provided as reference for planning. LEDiL Oy's optical specifications have been verified by conducting performance testing of the products in accordance with the company's quality system. The reported data are averaged results of multiple measurements with typical variation. LEDiL Oy reserves the right to without prior notification make changes and improvements to its products.

LEDiL Oy assumes neither warranty, nor guarantee nor any other liability of any kind for the contents and correctness of the provided data. The provided data has been generated with highest diligence but the provided data may in reality not represent the complete possible variation range of all intrinsic parameters. Therefore, in certain cases a deviation from the provided data could occur.

LEDiL Oy reserves the right to undertake technical changes of its products without further notification which could lead to changes in the provided data. LEDiL Oy assumes no liability of any kind for the possible deviation from any provided data or any other damage resulting from the usage of the provided data.

The user agrees to this disclaimer and user agreement with the download or usage of the provided files.

#### LEDiL Oy

Joensuunkatu 7  
FI-24240 SALO  
Finland

#### LEDiL Inc.

228 West Page Street  
Suite D  
Sycamore IL 60178  
USA

#### Ledil Optics Technology (Shenzhen) Co., Ltd.

# 405 , Block B  
Casic Motor Building  
Shenzhen 518057  
P.R.CHINA

#### Local sales and technical support

[www.ledil.com/  
where\\_to\\_buy](http://www.ledil.com/where_to_buy)

#### Shipping locations

Poznan, Poland  
Hong Kong, China

#### Distribution Partners

[www.ledil.com/  
where\\_to\\_buy](http://www.ledil.com/where_to_buy)