

LARISA-M-CLIP8

~30° medium beam. Clip fastening for 0.8 mm thick PCB.

SPECIFICATION:

Dimensions	9.9 x 9.9
Height	7.5 mm
Fastening	clips
ROHS compliant	yes ⓘ



MATERIALS:

Component	Type	Material	Colour	Finish	Length (mm)
LARISA-M	Single lens	PMMA	clear		
LARISA-HOLDER-CLIP8	Holder	PC	black		

ORDERING INFORMATION:

Component		Qty in box	MOQ	MPQ	Box weight (kg)
CP12940_LARISA-M-CLIP8	Single lens	10000	300	100	6.6
» Box size: 300 x 250 x 250 mm					

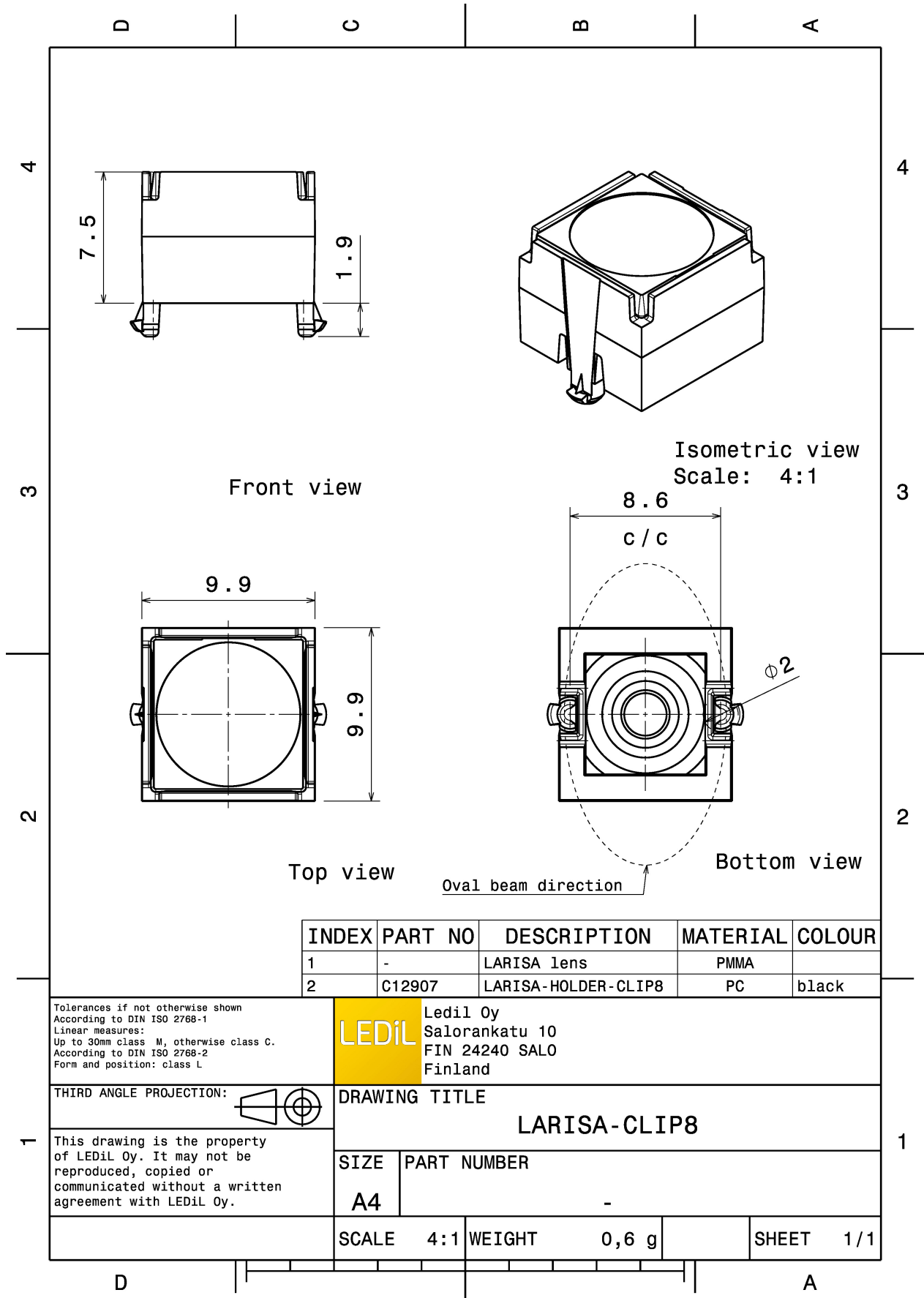

See also our general installation guide: www.ledil.com/installation_guide

OPTICAL RESULTS (MEASURED):



LED XB-D
FWHM / FWTM 30.0° / 58.0°
Efficiency 87 %
Peak intensity 2.3 cd/lm
LEDs/each optic 1
Light colour/type White
Required components:

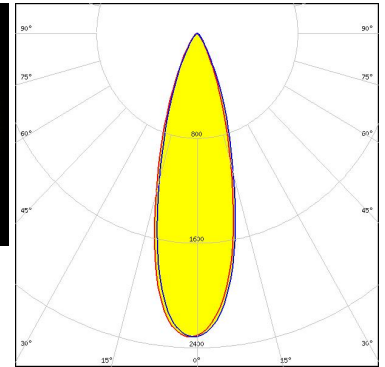

Light distribution files



LED XD16
FWHM / FWTM 27.0° / 57.0°
Efficiency 74 %
Peak intensity 2.2 cd/lm
LEDs/each optic 1
Light colour/type White
Required components:

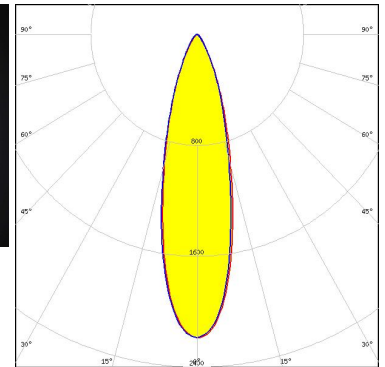
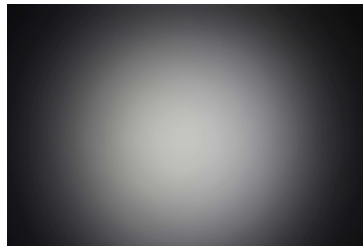

Light distribution files



LED XP-G
FWHM / FWTM 36.0° / 64.0°
Efficiency 88 %
Peak intensity 1.9 cd/lm
LEDs/each optic 1
Light colour/type White
Required components:

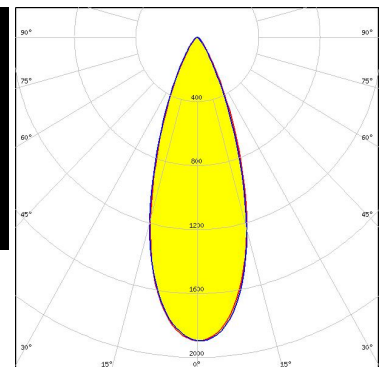
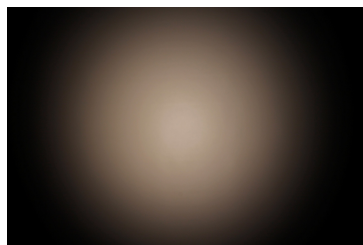

Light distribution files

OPTICAL RESULTS (MEASURED):



LED XQ-E HD
 FWHM / FWTM 25.0° / 53.0°
 Efficiency 86 %
 Peak intensity 3 cd/lm
 LEDs/each optic 1
 Light colour/type White
 Required components:

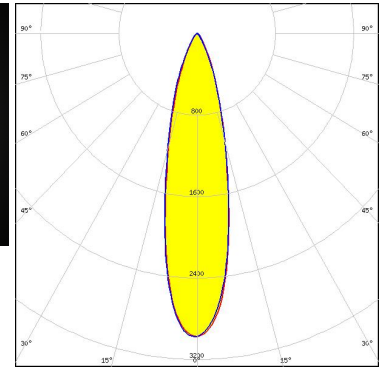
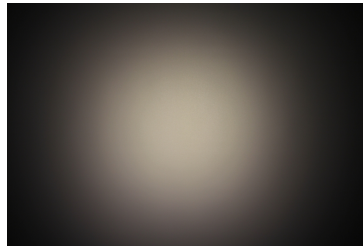

Light distribution files



LED XQ-E HI
 FWHM / FWTM 22.0° / 49.0°
 Efficiency 78 %
 Peak intensity 3.6 cd/lm
 LEDs/each optic 1
 Light colour/type White
 Required components:

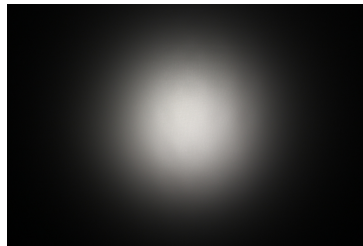

Light distribution files



LED LUXEON A
 FWHM / FWTM 37.0° / 67.0°
 Efficiency 86 %
 Peak intensity 1.7 cd/lm
 LEDs/each optic 1
 Light colour/type White
 Required components:

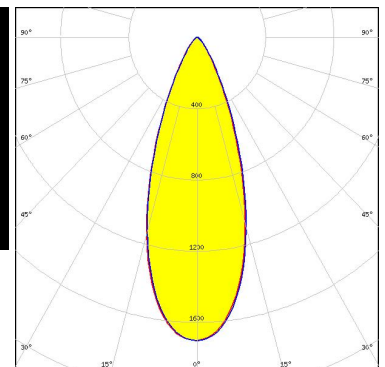
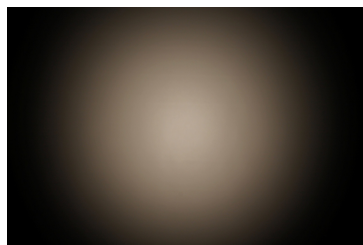

Light distribution files

OPTICAL RESULTS (MEASURED):



LED LUXEON Rebel
 FWHM / FWTM 26.0° / 53.0°
 Efficiency 88 %
 Peak intensity 3 cd/lm
 LEDs/each optic 1
 Light colour/type White
 Required components:

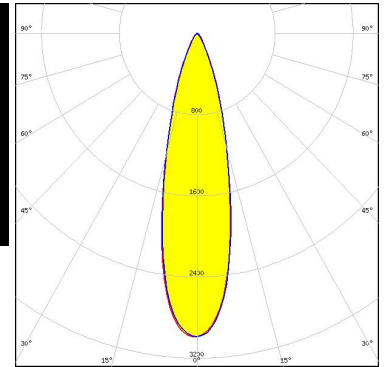
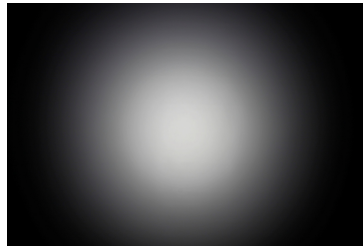

Light distribution files



LED LUXEON Rebel ES
 FWHM / FWTM 35.0° / 64.0°
 Efficiency 87 %
 Peak intensity 1.9 cd/lm
 LEDs/each optic 1
 Light colour/type White
 Required components:

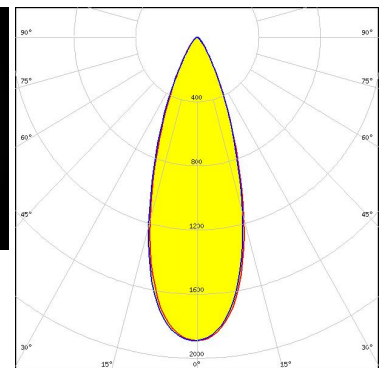
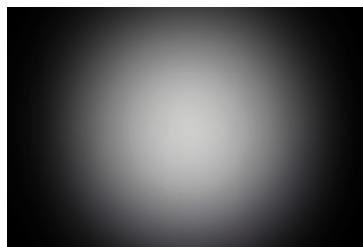

Light distribution files



LED LUXEON Z
 FWHM / FWTM 19.0° / 42.0°
 Efficiency 84 %
 Peak intensity 5 cd/lm
 LEDs/each optic 1
 Light colour/type White
 Required components:



Light distribution files

OPTICAL RESULTS (MEASURED):



LED LUXEON Z ES
FWHM / FWTM 24.0° / 50.0°
Efficiency 88 %
Peak intensity 3.3 cd/lm
LEDs/each optic 1
Light colour/type White
Required components:

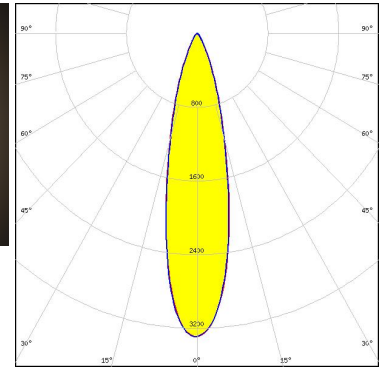
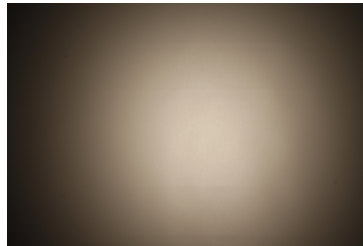

Light distribution files



LED NCSxx19A
FWHM / FWTM 27.0° / 57.0°
Efficiency 84 %
Peak intensity 2.5 cd/lm
LEDs/each optic 1
Light colour/type White
Required components:

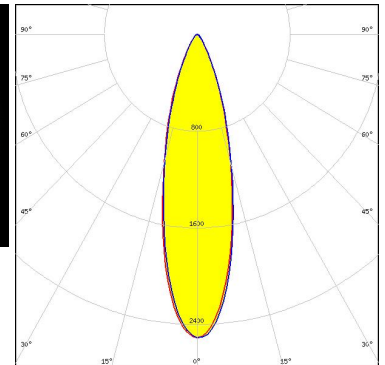
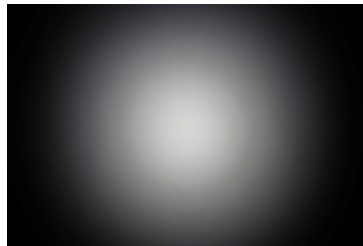

Light distribution files



LED NF2x757A
FWHM / FWTM 31.0° / 62.0°
Efficiency 84 %
Peak intensity 2.1 cd/lm
LEDs/each optic 1
Light colour/type White
Required components:

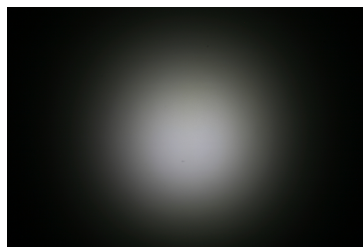

Light distribution files

OPTICAL RESULTS (MEASURED):



LED NF2x757G
FWHM / FWTM 34.0° / 70.0°
Efficiency 80 %
Peak intensity 1.6 cd/lm
LEDs/each optic 1
Light colour/type White
Required components:

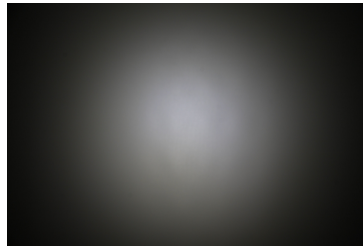

Light distribution files



LED NVSxx19A
FWHM / FWTM 34.0° / 65.0°
Efficiency 84 %
Peak intensity 1.9 cd/lm
LEDs/each optic 1
Light colour/type White
Required components:

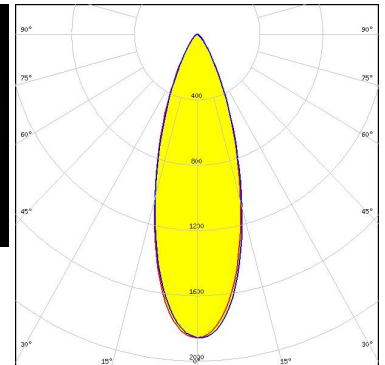
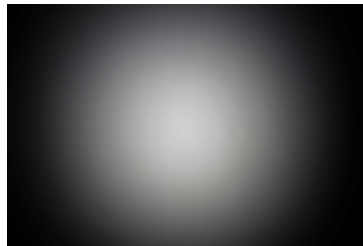

Light distribution files



LED Duris S5 (2 chip)
FWHM / FWTM 34.0° / 66.0°
Efficiency 80 %
Peak intensity 1.9 cd/lm
LEDs/each optic 1
Light colour/type White
Required components:

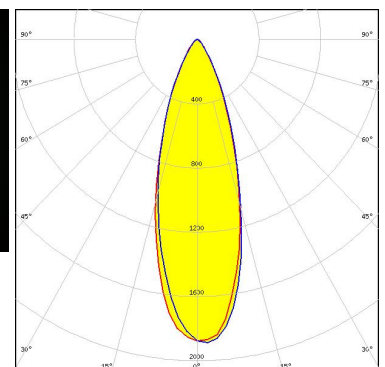
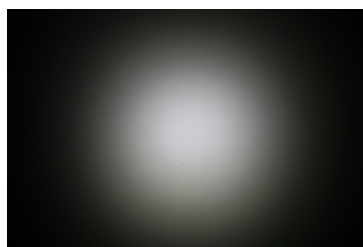

Light distribution files

OPTICAL RESULTS (MEASURED):

OSRAM
Opto Semiconductors

LED OSLON Square EC
 FWHM / FWTM 31.0° / 63.0°
 Efficiency 83 %
 Peak intensity 2 cd/lm
 LEDs/each optic 1
 Light colour/type White
 Required components:

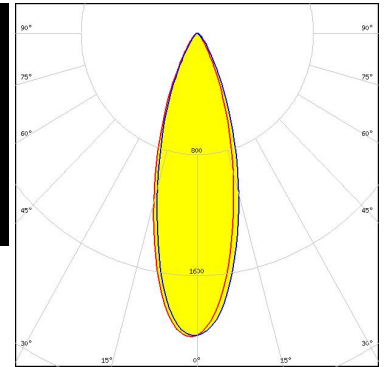
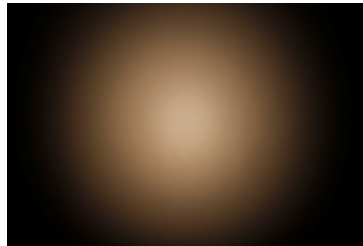

Light distribution files

OSRAM
Opto Semiconductors

LED OSLON SSL 150
 FWHM / FWTM 30.0° / 54.0°
 Efficiency 88 %
 Peak intensity 2.6 cd/lm
 LEDs/each optic 1
 Light colour/type White
 Required components:

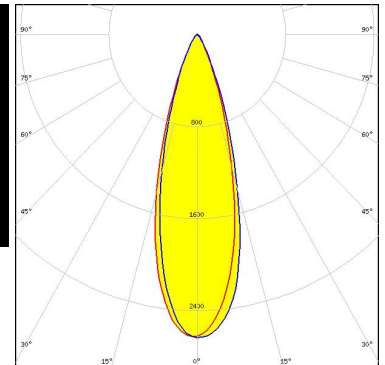
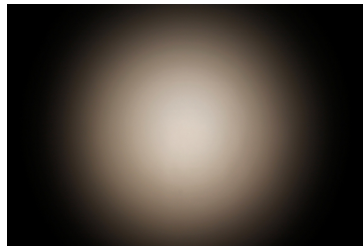

Light distribution files

OSRAM
Opto Semiconductors

LED OSLON SSL 80
 FWHM / FWTM 25.0° / 56.0°
 Efficiency 82 %
 Peak intensity 2.9 cd/lm
 LEDs/each optic 1
 Light colour/type White
 Required components:

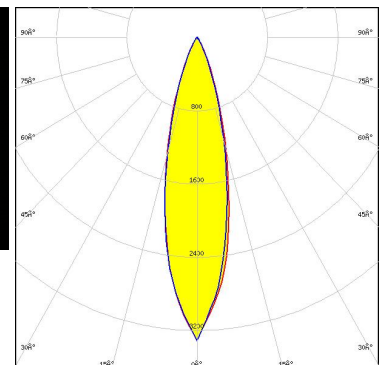
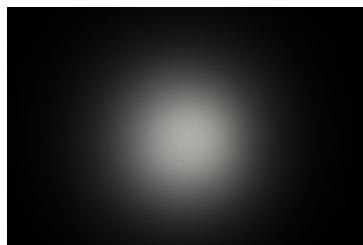

Light distribution files

OPTICAL RESULTS (SIMULATED):

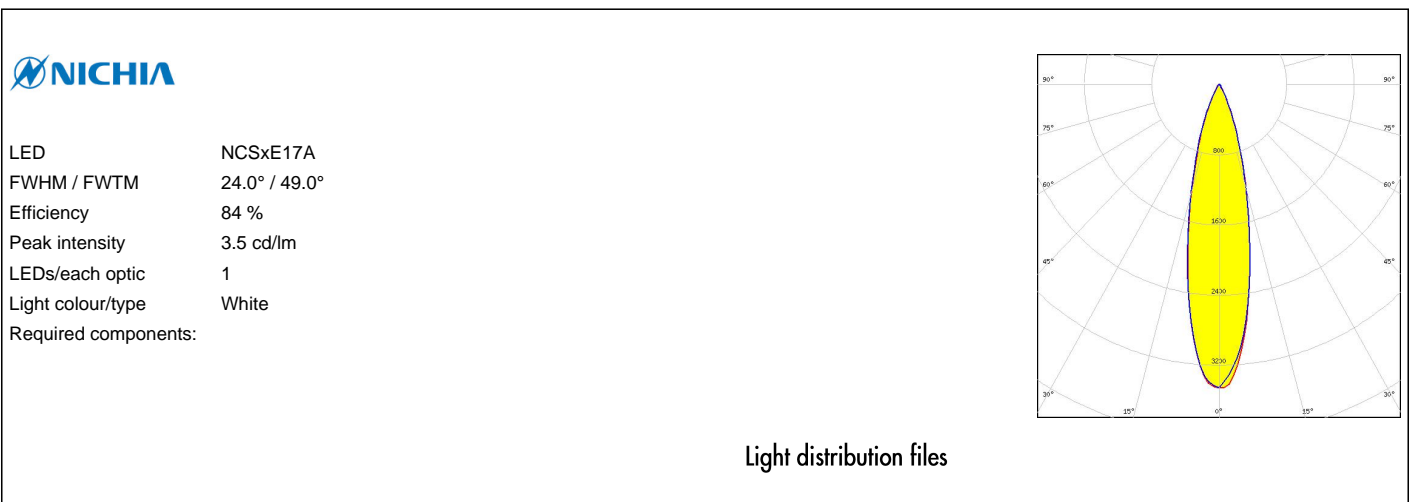
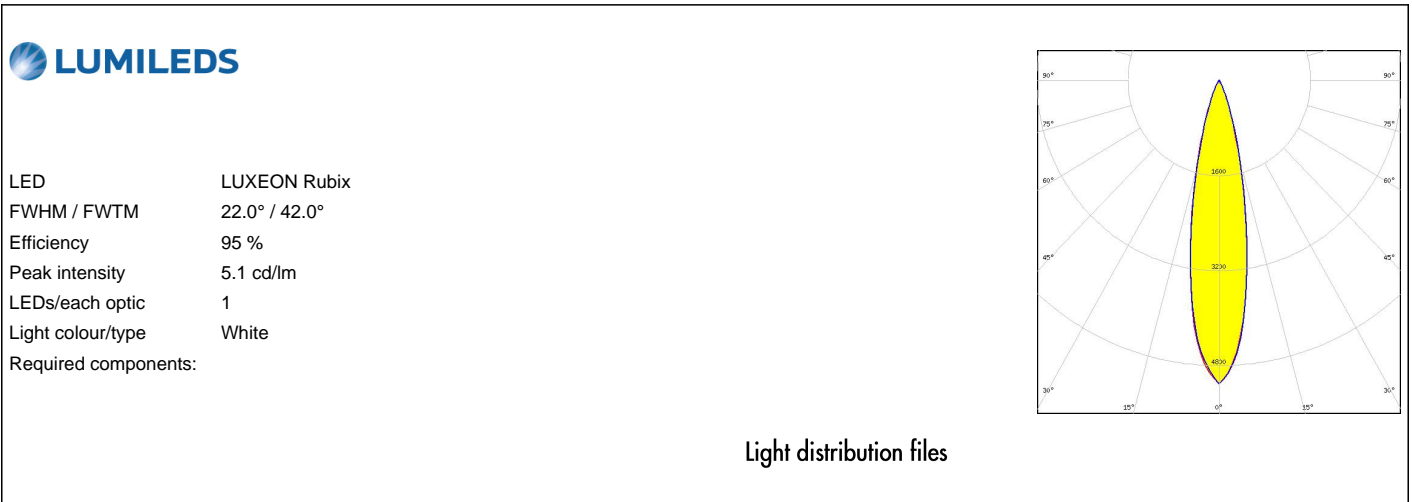

GENERAL INFORMATION:

NOTE: The typical beam angle will be changed by different color, chip size and chip position tolerance. The typical total beam angle is the full angle measured where the luminous intensity is half of the peak value.

MATERIALS:

As part of our continuous research and improvement processes, and to ensure the best possible quality and availability of our products, LEDiL reserves the right to change material grades without notice.

PRODUCT DATA USER AGREEMENT AND DISCLAIMER:

The measured data in the provided downloadable LEDiL Product Datasheets and Mechanical 2D-Drawings is rounded and provided as reference for planning. LEDiL Oy's optical specifications have been verified by conducting performance testing of the products in accordance with the company's quality system. The reported data are averaged results of multiple measurements with typical variation. LEDiL Oy reserves the right to without prior notification make changes and improvements to its products.

LEDiL Oy assumes neither warranty, nor guarantee nor any other liability of any kind for the contents and correctness of the provided data. The provided data has been generated with highest diligence but the provided data may in reality not represent the complete possible variation range of all intrinsic parameters. Therefore, in certain cases a deviation from the provided data could occur.

LEDiL Oy reserves the right to undertake technical changes of its products without further notification which could lead to changes in the provided data. LEDiL Oy assumes no liability of any kind for the possible deviation from any provided data or any other damage resulting from the usage of the provided data.

The user agrees to this disclaimer and user agreement with the download or usage of the provided files.

LEDiL Oy

Joensuunkatu 7
FI-24240 SALO
Finland

LEDiL Inc.

228 West Page Street
Suite D
Sycamore IL 60178
USA

Ledil Optics Technology (Shenzhen) Co., Ltd.

405 , Block B
Casic Motor Building
Shenzhen 518057
P.R.CHINA

Local sales and technical support

[www.ledil.com/
where_to_buy](http://www.ledil.com/where_to_buy)

Shipping locations

Poznan, Poland
Hong Kong, China

Distribution Partners

[www.ledil.com/
where_to_buy](http://www.ledil.com/where_to_buy)