

LAURA-D-PIN

~15° diffused spot beam optimized for CREE XP-E. Assembly with white holder, installation tape and location pins.

SPECIFICATION:

Dimensions	21.6 x 21.6
Height	13.1 mm
Fastening	tape, pin
ROHS compliant	yes ⓘ



MATERIALS:

Component	Type	Material	Colour	Finish	Length (mm)
LAURA-D	Single lens	PMMA	clear		
LAURA-PIN-XP-HLD-WHT	Holder	PC	white		
ROSE-TAPE	Tape	Acrylic foam	black		

ORDERING INFORMATION:

Component	Qty in box	MOQ	MPQ	Box weight (kg)
CA11960_LAURA-D-PIN	1440		180	7.5
» Box size:				

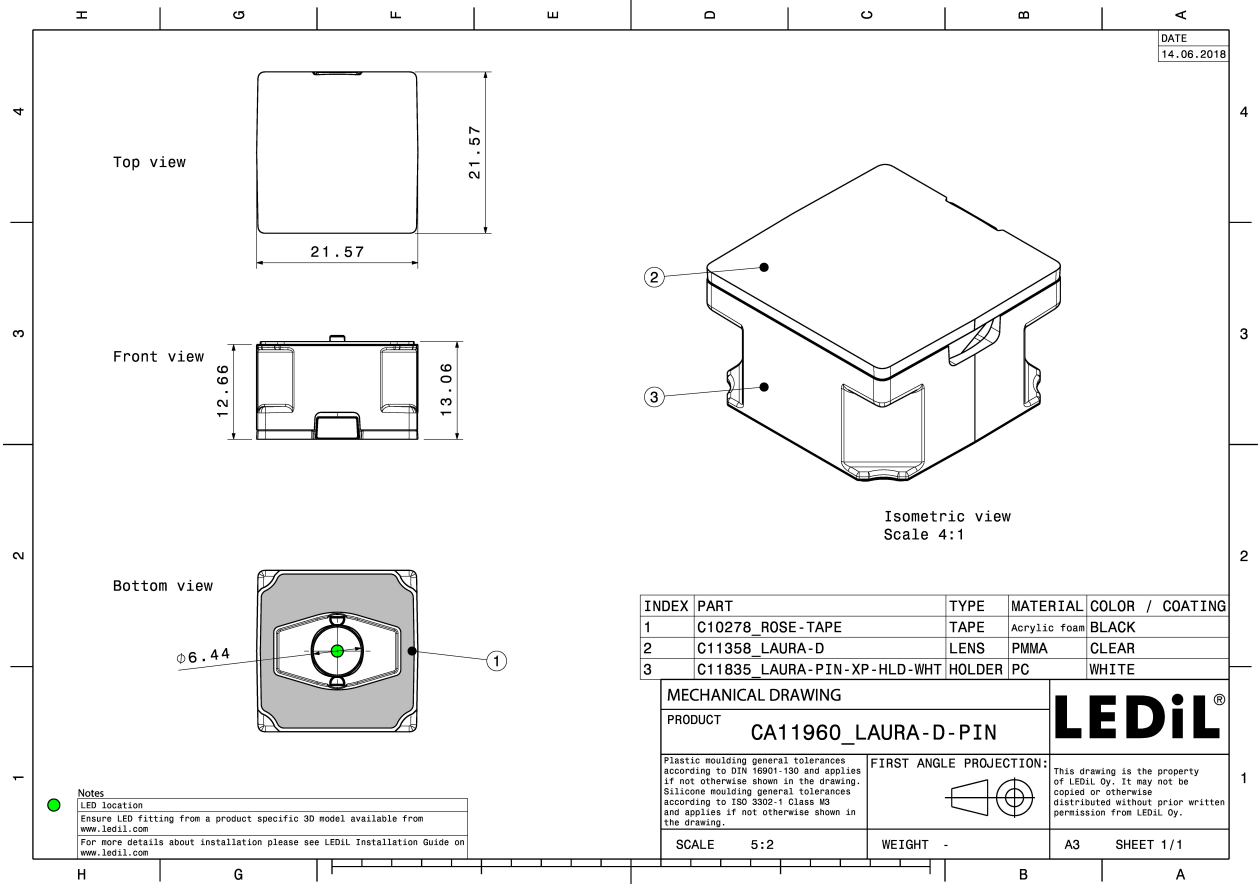

See also our general installation guide: www.ledil.com/installation_guide

OPTICAL RESULTS (MEASURED):



LED XP-E
FWHM / FWTM 13.0° / 31.0°
Efficiency 93 %
Peak intensity 9.3 cd/m
LEDs/each optic 1
Light colour/type White
Required components:



LED XP-E-HEW
FWHM / FWTM 15.0° / 33.0°
Efficiency 86 %
Peak intensity 6.2 cd/m
LEDs/each optic 1
Light colour/type White
Required components:



LED XP-E2
FWHM / FWTM 15.0° / 36.0°
Efficiency 88 %
Peak intensity 6.4 cd/m
LEDs/each optic 1
Light colour/type White
Required components:

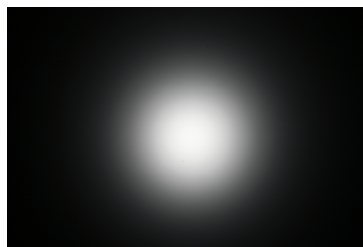

Light distribution files

OPTICAL RESULTS (MEASURED):



LED XP-G
FWHM / FWTM 16.0°
Efficiency 94 %
LEDs/each optic 1
Light colour/type White
Required components:



LED LUXEON Rebel
FWHM / FWTM 15.0° / 37.0°
Efficiency 90 %
Peak intensity 5 cd/lm
LEDs/each optic 1
Light colour/type White
Required components:



LED LUXEON T
FWHM / FWTM 18.0° / 40.0°
Efficiency 89 %
Peak intensity 4.5 cd/lm
LEDs/each optic 1
Light colour/type White
Required components:

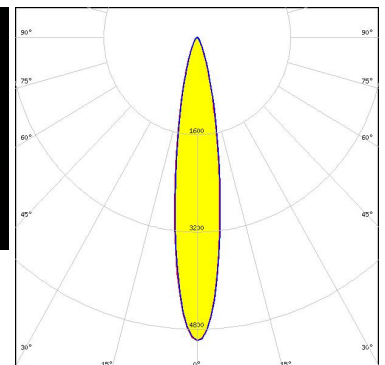

Light distribution files

OPTICAL RESULTS (MEASURED):



LED LUXEON Z ES
FWHM / FWTM 15.0° / 34.0°
Efficiency 90 %
Peak intensity 7.1 cd/lm
LEDs/each optic 1
Light colour/type White
Required components:



Light distribution files



LED NCSxx19B
FWHM / FWTM 19.0° / 41.0°
Efficiency 85 %
Peak intensity 5 cd/lm
LEDs/each optic 1
Light colour/type White
Required components:

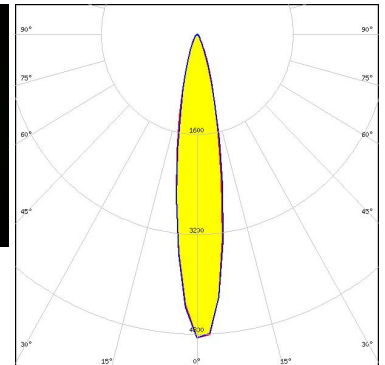

Light distribution files



LED NF2x757D
FWHM / FWTM 19.0° / 43.0°
Efficiency 84 %
Peak intensity 4.2 cd/lm
LEDs/each optic 1
Light colour/type White
Required components:

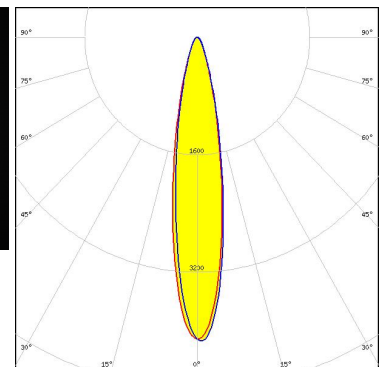
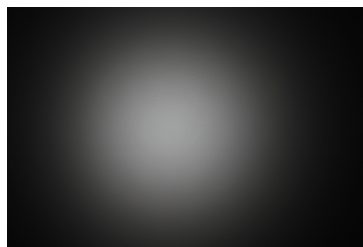

Light distribution files

OPTICAL RESULTS (MEASURED):

OSRAM

Opto Semiconductors

LED OSLON Square EC
FWHM / FWTM 16.0° / 34.0°
Efficiency 81 %
Peak intensity 6.7 cd/lm
LEDs/each optic 1
Light colour/type White
Required components:

OSRAM

Opto Semiconductors

LED OSLON SSL 150
FWHM / FWTM 12.0° / 28.0°
Efficiency 83 %
Peak intensity 8.9 cd/lm
LEDs/each optic 1
Light colour/type White
Required components:

OSRAM

Opto Semiconductors

LED OSLON SSL 80
FWHM / FWTM 14.0° / 31.0°
Efficiency 83 %
Peak intensity 7.3 cd/lm
LEDs/each optic 1
Light colour/type White
Required components:

OPTICAL RESULTS (MEASURED):

OSRAM
Opto Semiconductors

LED SFH 4725S
FWHM / FWTM 18.0° / 42.0°
Efficiency %
LEDs/each optic 1
Light colour/type White
Required components:

Light distribution files



SEOUL SEMICONDUCTOR

LED Z5
FWHM / FWTM 14.0°
Efficiency %
LEDs/each optic 1
Light colour/type White
Required components:

OPTICAL RESULTS (SIMULATED):

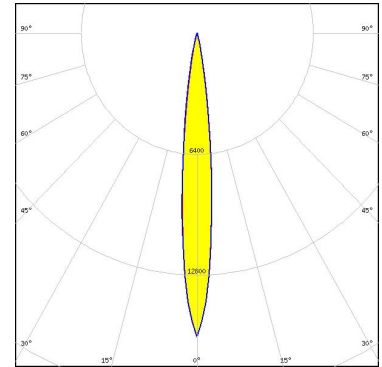

LED XD16
 FWHM / FWTM 12.0° / 23.0°
 Efficiency 90 %
 Peak intensity 16.1 cd/lm
 LEDs/each optic 1
 Light colour/type White
 Required components:



Light distribution files



LED XHP35.2 HD
 FWHM / FWTM 20.0° / 36.0°
 Efficiency 89 %
 Peak intensity 5.9 cd/lm
 LEDs/each optic 1
 Light colour/type White
 Required components:

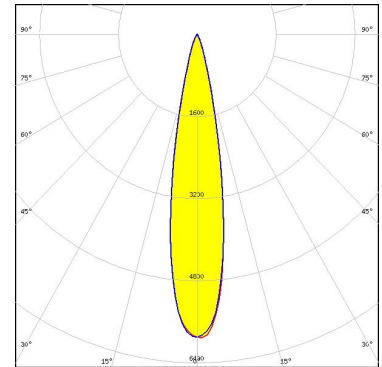

Light distribution files



LED XP-E2
 FWHM / FWTM 12.0° / 22.0°
 Efficiency 94 %
 Peak intensity 18 cd/lm
 LEDs/each optic 1
 Light colour/type Amber
 Required components:

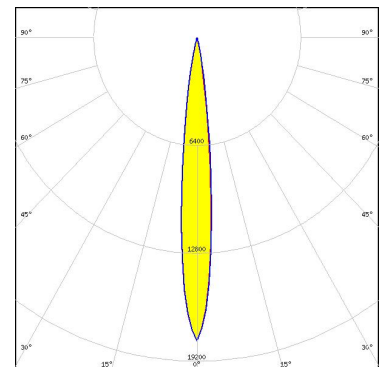

Light distribution files

OPTICAL RESULTS (SIMULATED):



LED XP-G3
FWHM / FWTM 17.0° / 32.0°
Efficiency 93 %
Peak intensity 8.2 cd/lm
LEDs/each optic 1
Light colour/type White
Required components:

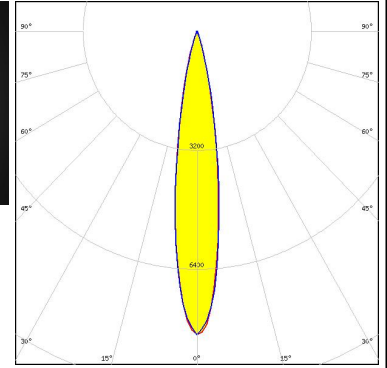

Light distribution files



LED LUXEON H50-2
FWHM / FWTM 13.0° / 28.0°
Efficiency 90 %
Peak intensity 9.5 cd/lm
LEDs/each optic 1
Light colour/type White
Required components:



LED LUXEON IR Domed 150 (L110-0xxx150000000)
FWHM / FWTM 9.0° / 18.0°
Efficiency 0 %
LEDs/each optic 1
Light colour/type White
Required components:

OPTICAL RESULTS (SIMULATED):



LED LUXEON IR Domed 60 (L110-0xxx060000000)
FWHM / FWTM 12.0° / 25.0°
Efficiency 94 %
LEDs/each optic 1
Light colour/type White
Required components:



LED LUXEON IR Domed 90 (L110-0xxx090000000)
FWHM / FWTM 12.0° / 24.0°
Efficiency 94 %
LEDs/each optic 1
Light colour/type White
Required components:



LED NV4WB35AM
FWHM / FWTM 16.0° / 32.0°
Efficiency 96 %
Peak intensity 8.5 cd/lm
LEDs/each optic 1
Light colour/type White
Required components:

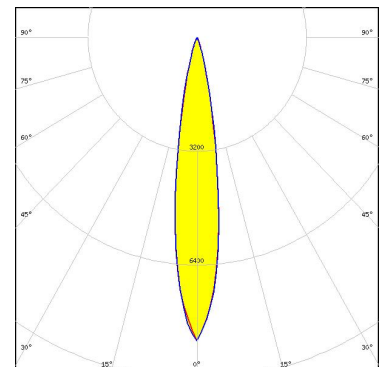

Light distribution files

OPTICAL RESULTS (SIMULATED):

OSRAM
Opto Semiconductors

LED OSLON Boost HX (KW CULPM1.TG)
FWHM / FWTM 10.0° / 20.0°
Efficiency 96 %
Peak intensity 21.9 cd/lm
LEDs/each optic 1
Light colour/type White
Required components:

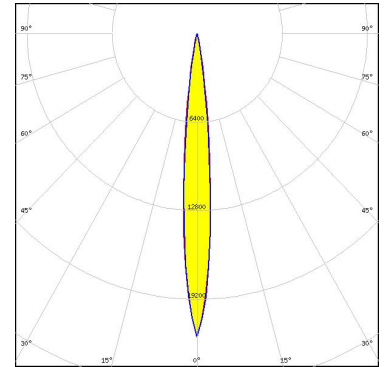

Light distribution files

OSRAM
Opto Semiconductors

LED OSLON Signal
FWHM / FWTM 10.0° / 20.0°
Efficiency 96 %
Peak intensity 23.8 cd/lm
LEDs/each optic 1
Light colour/type Red
Required components:

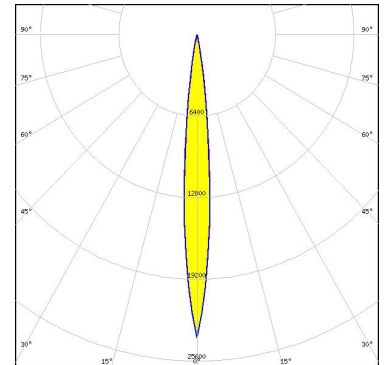

Light distribution files

OSRAM
Opto Semiconductors

LED OSLON Square CSSRM2/CSSRM3
FWHM / FWTM 12.0° / 24.0°
Efficiency 96 %
Peak intensity 15.9 cd/lm
LEDs/each optic 1
Light colour/type White
Required components:

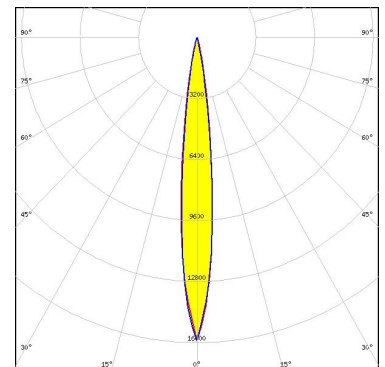

Light distribution files

OPTICAL RESULTS (SIMULATED):

OSRAM
Opto Semiconductors

LED	SFH 4715S
FWHM / FWTM	13.0°
Efficiency	%
LEDs/each optic	1
Light colour/type	White
Required components:	

GENERAL INFORMATION:

NOTE: The typical beam angle will be changed by different color, chip size and chip position tolerance. The typical total beam angle is the full angle measured where the luminous intensity is half of the peak value.

MATERIALS:

As part of our continuous research and improvement processes, and to ensure the best possible quality and availability of our products, LEDiL reserves the right to change material grades without notice.

PRODUCT DATA USER AGREEMENT AND DISCLAIMER:

The measured data in the provided downloadable LEDiL Product Datasheets and Mechanical 2D-Drawings is rounded and provided as reference for planning. LEDiL Oy's optical specifications have been verified by conducting performance testing of the products in accordance with the company's quality system. The reported data are averaged results of multiple measurements with typical variation. LEDiL Oy reserves the right to without prior notification make changes and improvements to its products.

LEDiL Oy assumes neither warranty, nor guarantee nor any other liability of any kind for the contents and correctness of the provided data. The provided data has been generated with highest diligence but the provided data may in reality not represent the complete possible variation range of all intrinsic parameters. Therefore, in certain cases a deviation from the provided data could occur.

LEDiL Oy reserves the right to undertake technical changes of its products without further notification which could lead to changes in the provided data. LEDiL Oy assumes no liability of any kind for the possible deviation from any provided data or any other damage resulting from the usage of the provided data.

The user agrees to this disclaimer and user agreement with the download or usage of the provided files.

LEDiL Oy

Joensuunkatu 7
FI-24240 SALO
Finland

LEDiL Inc.

228 West Page Street
Suite D
Sycamore IL 60178
USA

Ledil Optics Technology (Shenzhen) Co., Ltd.

405 , Block B
Casic Motor Building
Shenzhen 518057
P.R.CHINA

Local sales and technical support

[www.ledil.com/
where_to_buy](http://www.ledil.com/where_to_buy)

Shipping locations

Poznan, Poland
Hong Kong, China

Distribution Partners

[www.ledil.com/
where_to_buy](http://www.ledil.com/where_to_buy)