

## LXP2-M

~25° medium beam optimized for CREE XP-E.  
14.7 mm high assembly with installation tape.

### SPECIFICATION:

Dimensions	Ø 21.6
Height	14.7 mm
Fastening	tape
ROHS compliant	yes ⓘ



### MATERIALS:

Component	Type	Material	Colour	Finish	Length (mm)
LXP2-M	Single lens	PMMA	clear		
LXP2-LH1-TAPE-BLK	Holder	PC	black		
HEIDI-TAPE	Tape	Acrylic foam	black		

### ORDERING INFORMATION:

Component	Qty in box	MOQ	MPQ	Box weight (kg)
CA11483_LXP2-M » Box size: 480 x 280 x 300 mm	1680	336	112	9.0

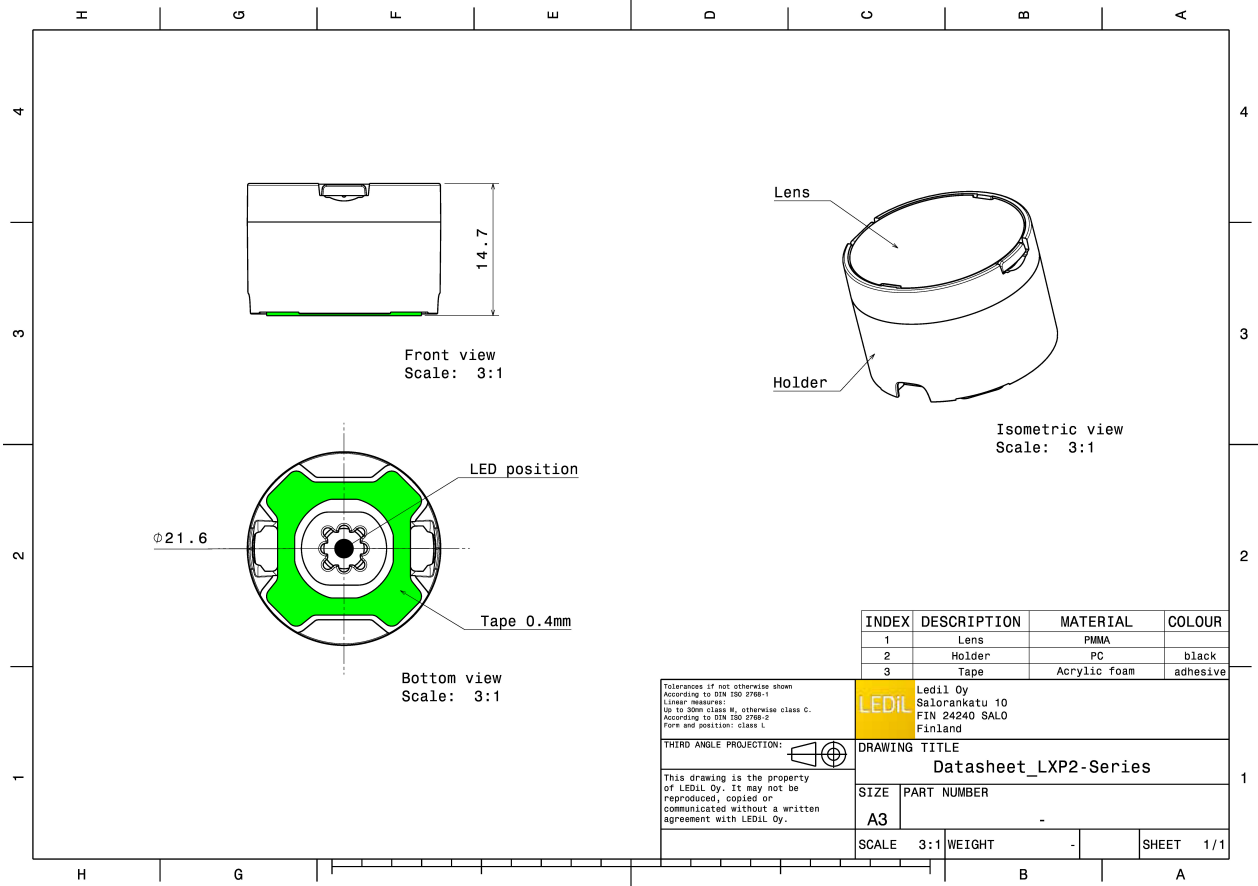

See also our general installation guide: [www.ledil.com/installation\\_guide](http://www.ledil.com/installation_guide)

### OPTICAL RESULTS (MEASURED):



LED XP-E  
FWHM / FWTM 23.0° / 38.0°  
Efficiency 94 %  
Peak intensity 4.6 cd/lm  
LEDs/each optic 1  
Light colour/type White  
Required components:



LED XP-E-HEW  
FWHM / FWTM 23.0°  
Efficiency 93 %  
LEDs/each optic 1  
Light colour/type White  
Required components:



LED XP-E2  
FWHM / FWTM 23.0° / 38.0°  
Efficiency 88 %  
Peak intensity 5.2 cd/lm  
LEDs/each optic 1  
Light colour/type White  
Required components:

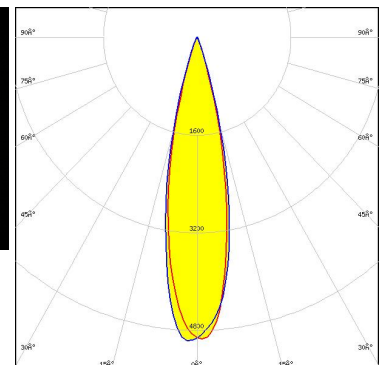
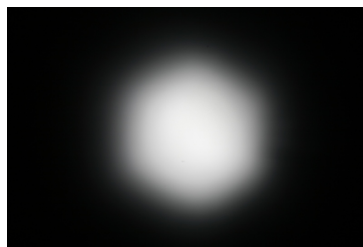

Light distribution files

### OPTICAL RESULTS (MEASURED):



LED XP-G  
FWHM / FWTM 24.0°  
Efficiency 94 %  
LEDs/each optic 1  
Light colour/type White  
Required components:



LED XP-G2  
FWHM / FWTM 23.0° / 40.0°  
Efficiency 90 %  
Peak intensity 5 cd/lm  
LEDs/each optic 1  
Light colour/type White  
Required components:

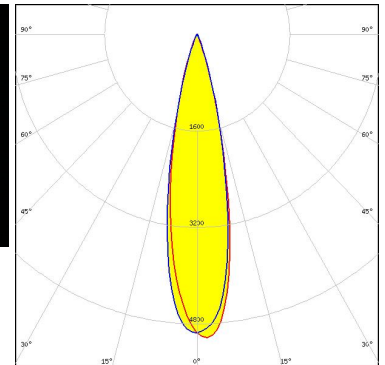
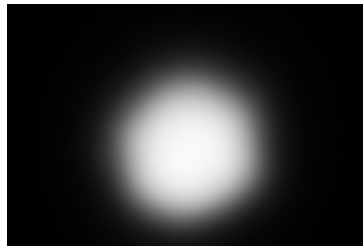

Light distribution files



LED XP-L HI  
FWHM / FWTM 24.0° / 41.0°  
Efficiency 87 %  
Peak intensity 4.7 cd/lm  
LEDs/each optic 1  
Light colour/type White  
Required components:

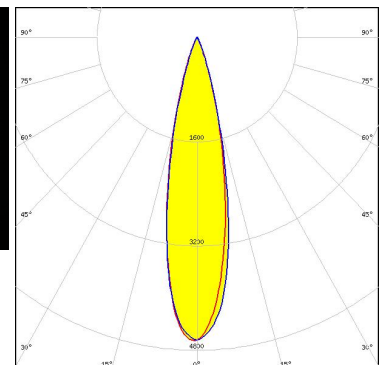

Light distribution files

### OPTICAL RESULTS (MEASURED):



LED XT-E  
 FWHM / FWTM 24.0° / 42.0°  
 Efficiency 88 %  
 Peak intensity 3.9 cd/lm  
 LEDs/each optic 1  
 Light colour/type White  
 Required components:

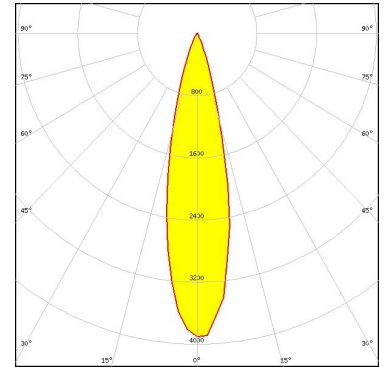

Light distribution files



LED LUXEON Q  
 FWHM / FWTM 24.0° / 42.0°  
 Efficiency 87 %  
 Peak intensity 4.3 cd/lm  
 LEDs/each optic 1  
 Light colour/type White  
 Required components:

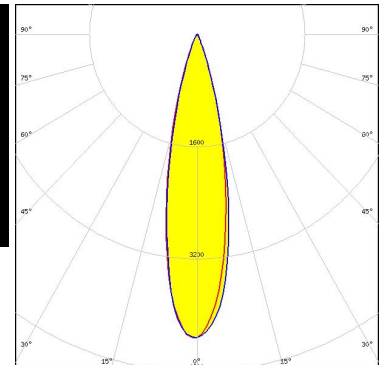

Light distribution files



LED NVSW219D  
 FWHM / FWTM 24.0° / 42.0°  
 Efficiency 89 %  
 Peak intensity 4.7 cd/lm  
 LEDs/each optic 1  
 Light colour/type White  
 Required components:

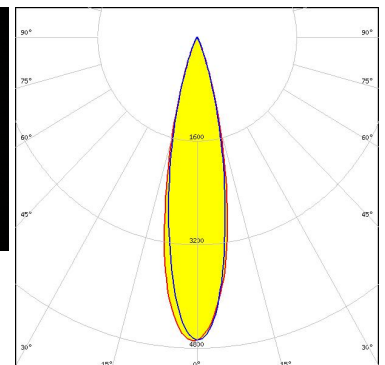
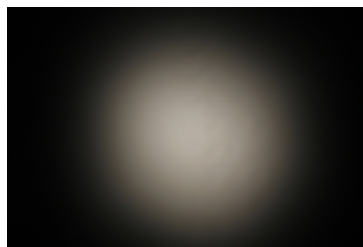

Light distribution files

### OPTICAL RESULTS (MEASURED):

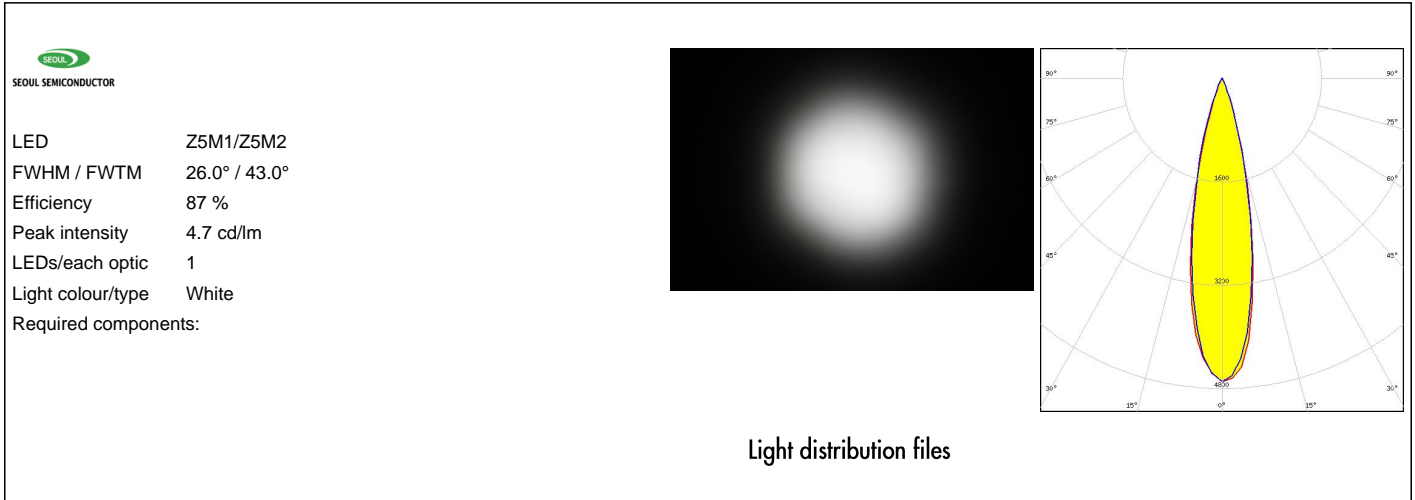

### OPTICAL RESULTS (SIMULATED):



LED XHP35.2 HD  
FWHM / FWTM 26.0° / 50.0°  
Efficiency 73 %  
Peak intensity 2.8 cd/lm  
LEDs/each optic 1  
Light colour/type White  
Required components:

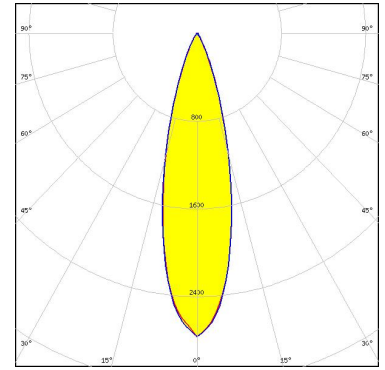

Light distribution files



LED XHP35.2 HI  
FWHM / FWTM 26.0° / 48.0°  
Efficiency 79 %  
Peak intensity 3.1 cd/lm  
LEDs/each optic 1  
Light colour/type White  
Required components:

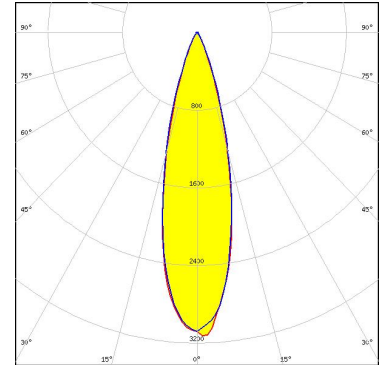

Light distribution files



LED XP-L HD  
FWHM / FWTM 24.0° / 45.0°  
Efficiency 86 %  
Peak intensity 4.2 cd/lm  
LEDs/each optic 1  
Light colour/type White  
Required components:

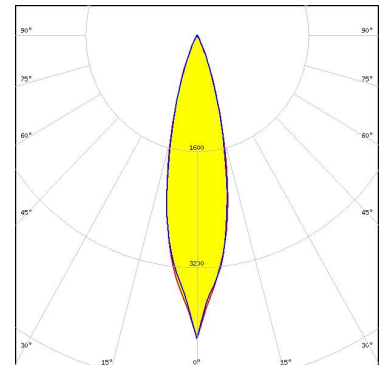

Light distribution files

### OPTICAL RESULTS (SIMULATED):

#### SAMSUNG

LED LM301B  
FWHM / FWTM 26.0° / 44.0°  
Efficiency 93 %  
Peak intensity 4.4 cd/lm  
LEDs/each optic 1  
Light colour/type White  
Required components:

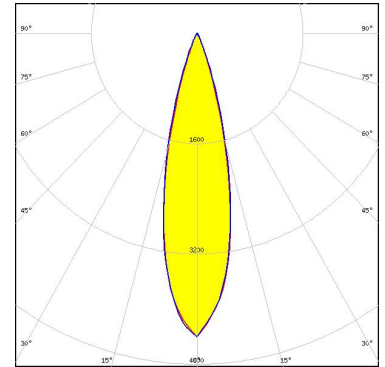

Light distribution files



LED Z5  
FWHM / FWTM 25.0°  
Efficiency %  
LEDs/each optic 1  
Light colour/type White  
Required components:



LED Z8Y22P  
FWHM / FWTM 26.0° / 46.0°  
Efficiency 89 %  
Peak intensity 3.9 cd/lm  
LEDs/each optic 1  
Light colour/type White  
Required components:

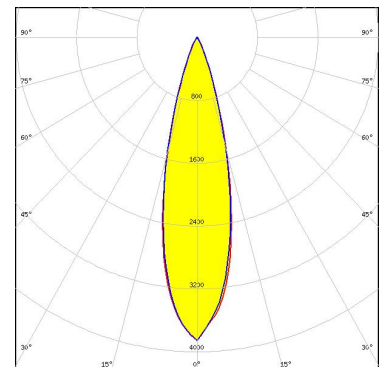

Light distribution files



### GENERAL INFORMATION:

NOTE: The typical beam angle will be changed by different color, chip size and chip position tolerance. The typical total beam angle is the full angle measured where the luminous intensity is half of the peak value.

### MATERIALS:

As part of our continuous research and improvement processes, and to ensure the best possible quality and availability of our products, LEDiL reserves the right to change material grades without notice.

### PRODUCT DATA USER AGREEMENT AND DISCLAIMER:

The measured data in the provided downloadable LEDiL Product Datasheets and Mechanical 2D-Drawings is rounded and provided as reference for planning. LEDiL Oy's optical specifications have been verified by conducting performance testing of the products in accordance with the company's quality system. The reported data are averaged results of multiple measurements with typical variation. LEDiL Oy reserves the right to without prior notification make changes and improvements to its products.

LEDiL Oy assumes neither warranty, nor guarantee nor any other liability of any kind for the contents and correctness of the provided data. The provided data has been generated with highest diligence but the provided data may in reality not represent the complete possible variation range of all intrinsic parameters. Therefore, in certain cases a deviation from the provided data could occur.

LEDiL Oy reserves the right to undertake technical changes of its products without further notification which could lead to changes in the provided data. LEDiL Oy assumes no liability of any kind for the possible deviation from any provided data or any other damage resulting from the usage of the provided data.

The user agrees to this disclaimer and user agreement with the download or usage of the provided files.

#### LEDiL Oy

Joensuunkatu 7  
FI-24240 SALO  
Finland

#### LEDiL Inc.

228 West Page Street  
Suite D  
Sycamore IL 60178  
USA

#### Ledil Optics Technology (Shenzhen) Co., Ltd.

# 405 , Block B  
Casic Motor Building  
Shenzhen 518057  
P.R.CHINA

#### Local sales and technical support

[www.ledil.com/  
where\\_to\\_buy](http://www.ledil.com/where_to_buy)

#### Shipping locations

Poznan, Poland  
Hong Kong, China

#### Distribution Partners

[www.ledil.com/  
where\\_to\\_buy](http://www.ledil.com/where_to_buy)