

LR2-W

~40° wide beam optimized for LUXEON Rebel ES. 14.8 mm high assembly with installation tape.

SPECIFICATION:

Dimensions	Ø 21.6
Height	14.8 mm
Fastening	tape, pin
ROHS compliant	yes ⓘ



MATERIALS:

Component	Type	Material	Colour	Finish	Length (mm)
LXP2-W	Single lens	PMMA			
LR2-ES-LH1-HLD	Holder	PC	white		
HEIDI-TAPE	Tape	Acrylic foam	black		

ORDERING INFORMATION:

Component	Qty in box	MOQ	MPQ	Box weight (kg)
CA12394_LR2-W » Box size: 480 x 280 x 300 mm	1680	336	112	9.4

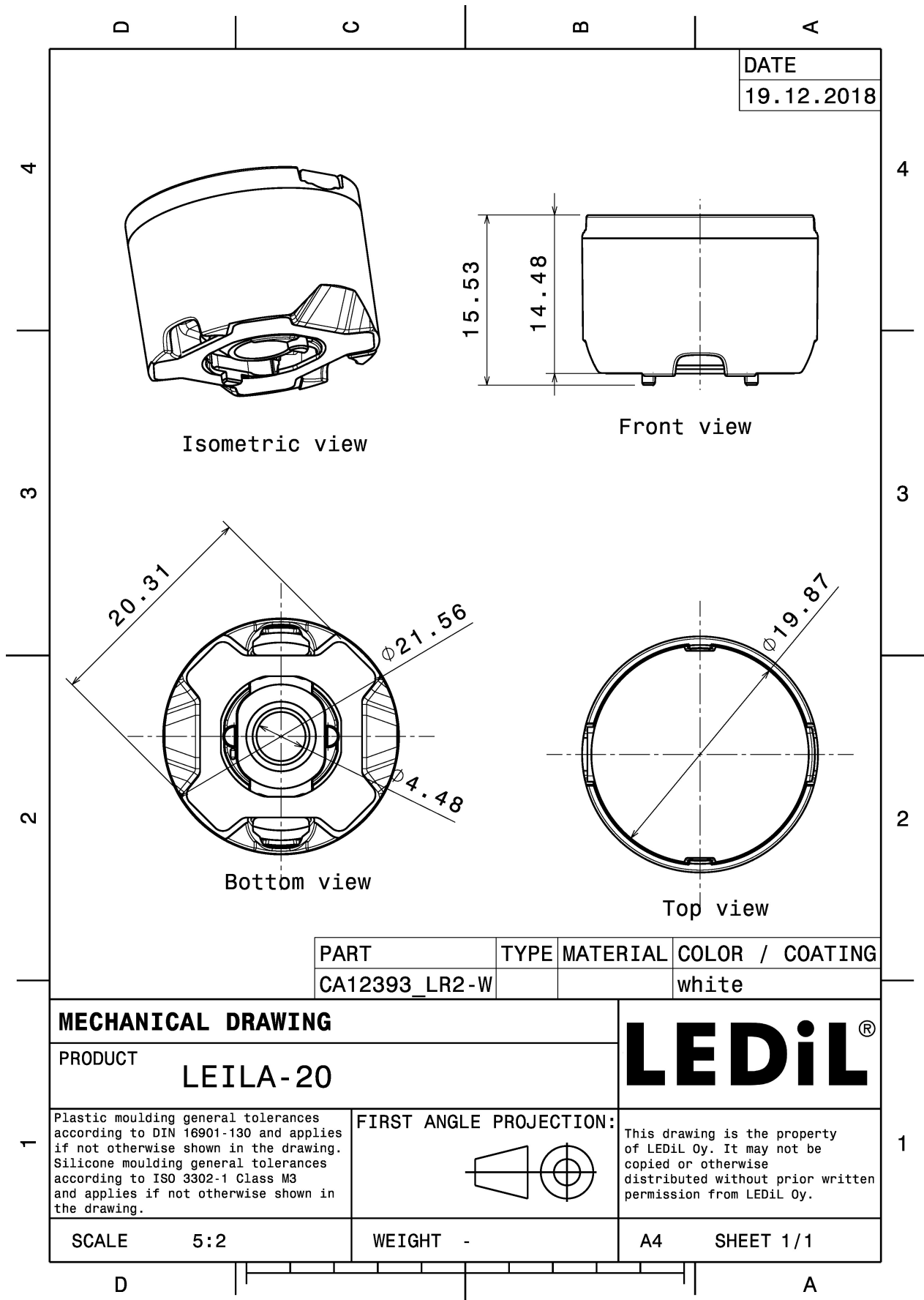

See also our general installation guide: www.ledil.com/installation_guide

OPTICAL RESULTS (MEASURED):

LUMILEDS

LED LUXEON T
FWHM / FWTM 46.0° / 69.0°
Efficiency 89 %
Peak intensity 1.4 cd/lm
LEDs/each optic 1
Light colour/type White
Required components:

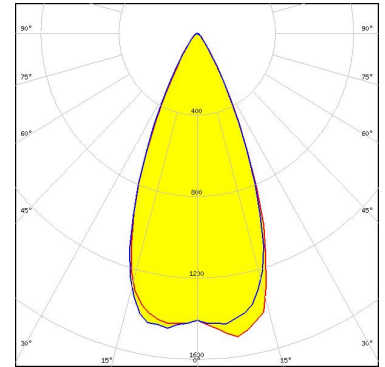

Light distribution files

LUMILEDS

LED LUXEON TX
FWHM / FWTM 45.0° / 68.0°
Efficiency 90 %
Peak intensity 1.6 cd/lm
LEDs/each optic 1
Light colour/type White
Required components:

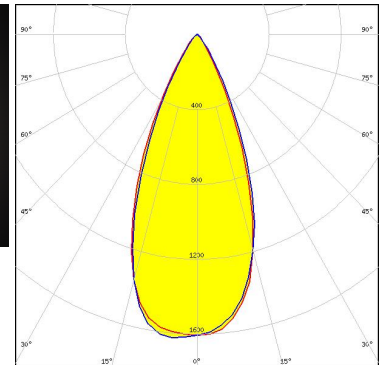
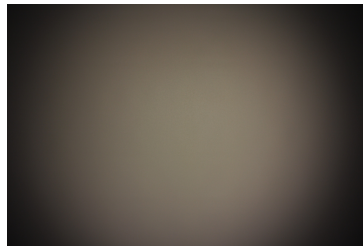

Light distribution files

LUMILEDS

LED LUXEON Z ES
FWHM / FWTM 43.0° / 64.0°
Efficiency 88 %
Peak intensity 1.8 cd/lm
LEDs/each optic 1
Light colour/type White
Required components:

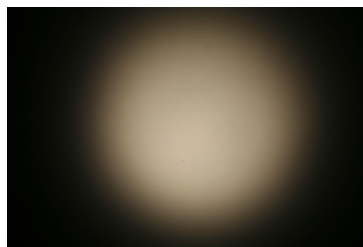

Light distribution files

OPTICAL RESULTS (MEASURED):

OSRAM
Opto Semiconductors

LED	SFH 4770S
FWHM / FWTM	39.0° / 62.0°
Efficiency	92 %
LEDs/each optic	1
Light colour/type	IR
Required components:	

Light distribution files

OPTICAL RESULTS (SIMULATED):



LED J Series 5050 Round LES
FWHM / FWTM 50.0° / 76.0°
Efficiency 96 %
Peak intensity 1.3 cd/lm
LEDs/each optic 1
Light colour/type White
Required components:

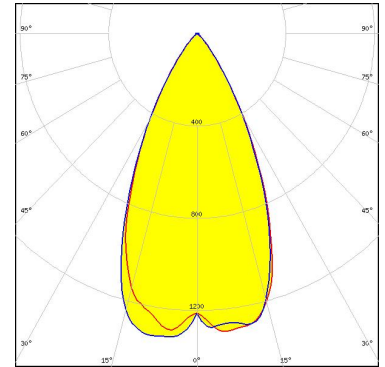

Light distribution files



LED XP-G3
FWHM / FWTM 46.0° / 68.0°
Efficiency 93 %
Peak intensity 1.6 cd/lm
LEDs/each optic 1
Light colour/type Red
Required components:

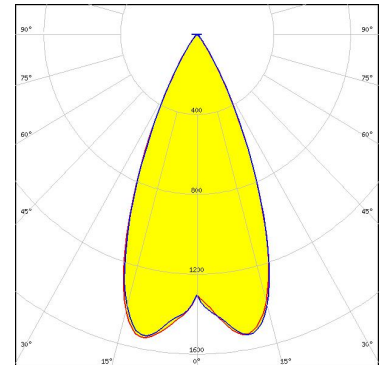

Light distribution files



LED XQ-E HD
FWHM / FWTM 48.0° / 64.0°
Efficiency 95 %
Peak intensity 1.7 cd/lm
LEDs/each optic 1
Light colour/type White
Required components:

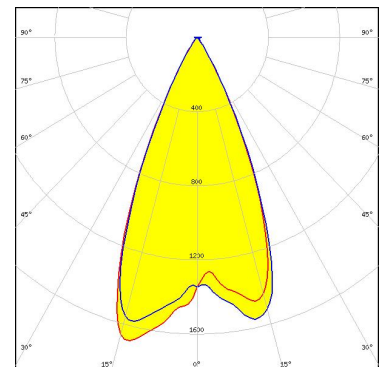

Light distribution files

OPTICAL RESULTS (SIMULATED):



LED LUXEON 5050 Round LES
FWHM / FWTM 50.0° / 76.0°
Efficiency 96 %
Peak intensity 1.4 cd/lm
LEDs/each optic 1
Light colour/type White
Required components:

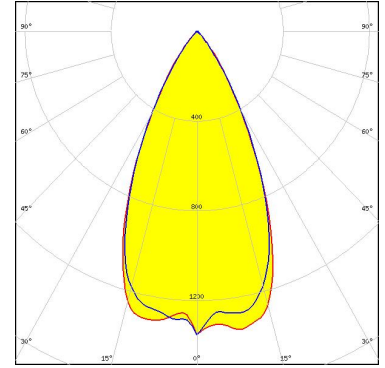

Light distribution files



LED LUXEON 5050 Square LES
FWHM / FWTM 52.0° / 78.0°
Efficiency 96 %
Peak intensity 1.3 cd/lm
LEDs/each optic 1
Light colour/type White
Required components:

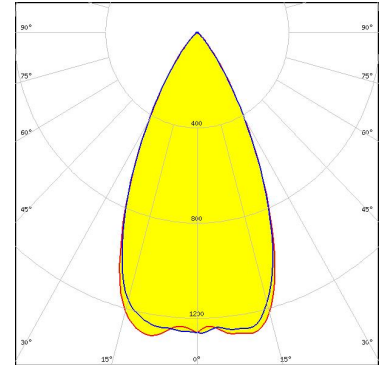

Light distribution files



LED LUXEON Rebel ES
FWHM / FWTM 48.0° / 66.0°
Efficiency 95 %
Peak intensity 1.6 cd/lm
LEDs/each optic 1
Light colour/type White
Required components:

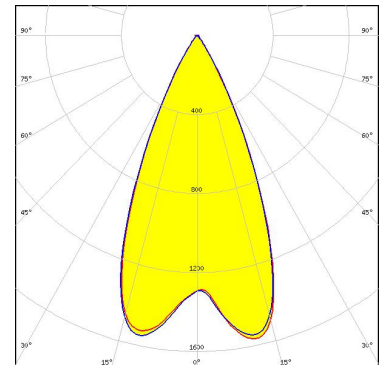

Light distribution files

OPTICAL RESULTS (SIMULATED):



LED LUXEON V2
FWHM / FWTM 43.0° / 60.0°
Efficiency 94 %
Peak intensity 1.7 cd/lm
LEDs/each optic 1
Light colour/type White
Required components:

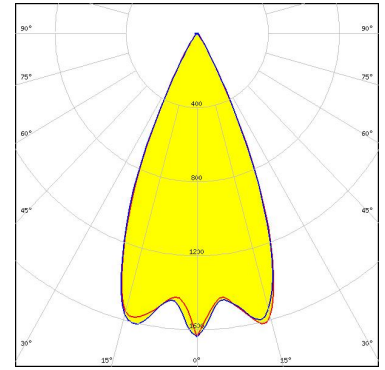

Light distribution files



LED NV4WB35AM
FWHM / FWTM 50.0° / 70.0°
Efficiency 96 %
Peak intensity 1.5 cd/lm
LEDs/each optic 1
Light colour/type White
Required components:

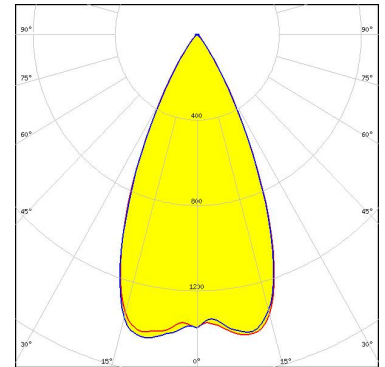

Light distribution files



LED OSCONIQ P 3030
FWHM / FWTM 44.0° / 62.0°
Efficiency 95 %
Peak intensity 1.9 cd/lm
LEDs/each optic 1
Light colour/type Blue
Required components:

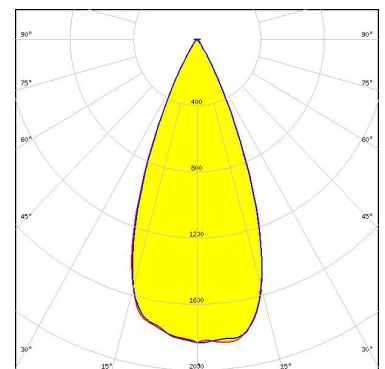

Light distribution files

OPTICAL RESULTS (SIMULATED):

OSRAM
Opto Semiconductors

LED OSOLON Square CSSRM2/CSSRM3
FWHM / FWTM 47.0° / 66.0°
Efficiency 96 %
Peak intensity 1.6 cd/lm
LEDs/each optic 1
Light colour/type White
Required components:

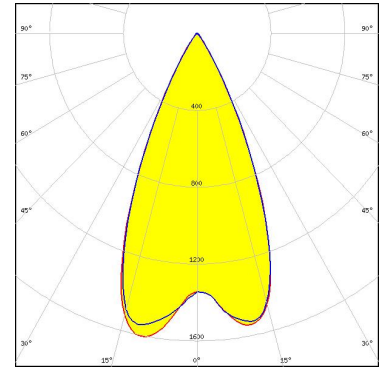

Light distribution files

OSRAM
Opto Semiconductors

LED SFH 4715AS
FWHM / FWTM 46.0° / 64.0°
Efficiency 95 %
LEDs/each optic 1
Light colour/type IR
Required components:

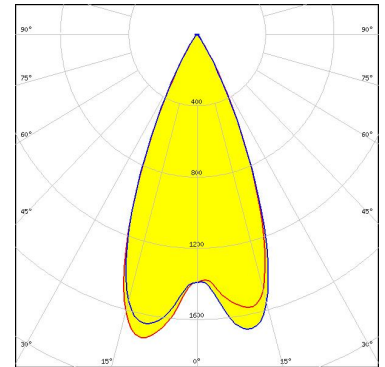

Light distribution files

OSRAM
Opto Semiconductors

LED SFH 4716AS
FWHM / FWTM 38.0° / 58.0°
Efficiency 94 %
LEDs/each optic 1
Light colour/type IR
Required components:

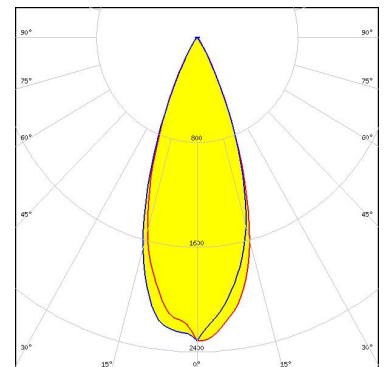

Light distribution files

GENERAL INFORMATION:

NOTE: The typical beam angle will be changed by different color, chip size and chip position tolerance. The typical total beam angle is the full angle measured where the luminous intensity is half of the peak value.

MATERIALS:

As part of our continuous research and improvement processes, and to ensure the best possible quality and availability of our products, LEDiL reserves the right to change material grades without notice.

PRODUCT DATA USER AGREEMENT AND DISCLAIMER:

The measured data in the provided downloadable LEDiL Product Datasheets and Mechanical 2D-Drawings is rounded and provided as reference for planning. LEDiL Oy's optical specifications have been verified by conducting performance testing of the products in accordance with the company's quality system. The reported data are averaged results of multiple measurements with typical variation. LEDiL Oy reserves the right to without prior notification make changes and improvements to its products.

LEDiL Oy assumes neither warranty, nor guarantee nor any other liability of any kind for the contents and correctness of the provided data. The provided data has been generated with highest diligence but the provided data may in reality not represent the complete possible variation range of all intrinsic parameters. Therefore, in certain cases a deviation from the provided data could occur.

LEDiL Oy reserves the right to undertake technical changes of its products without further notification which could lead to changes in the provided data. LEDiL Oy assumes no liability of any kind for the possible deviation from any provided data or any other damage resulting from the usage of the provided data.

The user agrees to this disclaimer and user agreement with the download or usage of the provided files.

LEDiL Oy

Joensuunkatu 7
FI-24240 SALO
Finland

LEDiL Inc.

228 West Page Street
Suite D
Sycamore IL 60178
USA

Ledil Optics Technology (Shenzhen) Co., Ltd.

405 , Block B
Casic Motor Building
Shenzhen 518057
P.R.CHINA

Local sales and technical support

[www.ledil.com/
where_to_buy](http://www.ledil.com/where_to_buy)

Shipping locations

Poznan, Poland
Hong Kong, China

Distribution Partners

[www.ledil.com/
where_to_buy](http://www.ledil.com/where_to_buy)