

LENA-S

~11° spot beam

SPECIFICATION:

Dimensions	Ø 111.0
Height	80 mm
Fastening	socket
ROHS compliant	yes ⓘ

MATERIALS:

Component	Type	Material	Colour	Finish	Coating
LENA-S	Reflector	PC	metal		lacquer



ORDERING INFORMATION:

Component	Qty in box	MOQ	MPQ	Box weight (kg)
C11979_LENA-S » Box size: 400 x 280 x 380 mm	60	60	60	3.8

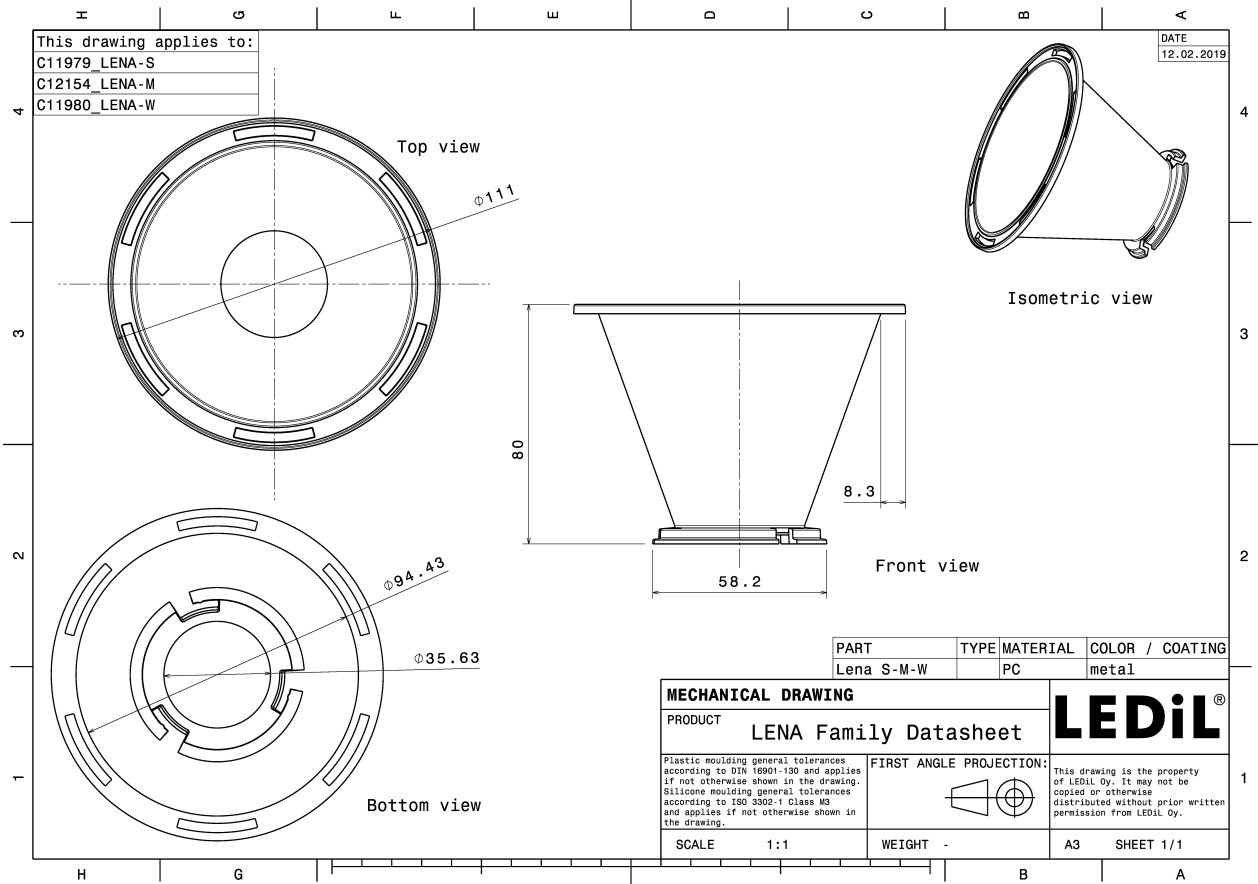

See also our general installation guide: www.ledil.com/installation_guide

OPTICAL RESULTS (MEASURED):



LED BXRA ES Rectangle
FWHM / FWTM 11.0° / 25.0°
Efficiency 78 %
LEDs/each optic 1
Light colour/type White
Required components:
C12153_LENA-STD-BASE-BXRA
C11996_LENA-LENS



LED BXRA RS
FWHM / FWTM 20.0°
Efficiency 80 %
LEDs/each optic 1
Light colour/type White
Required components:
C12229_LENA-STD-BASE-RS
C11996_LENA-LENS

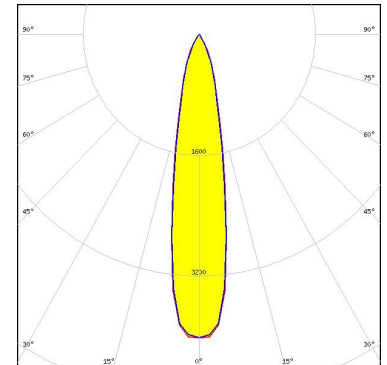

Light distribution files



LED V10 Gen6
FWHM / FWTM 9.0° / 24.0°
Efficiency 76 %
Peak intensity 12.1 cd/lm
LEDs/each optic 1
Light colour/type White
Required components:
C13186_LENA-STD-BASE-CXA15
C11996_LENA-LENS

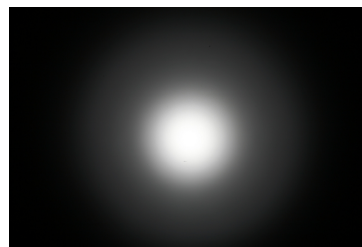

Light distribution files

OPTICAL RESULTS (MEASURED):



LED Vero SE 29
FWHM / FWTM 27.0° / 55.0°
Efficiency 87 %
Peak intensity 3.1 cd/lm
LEDs/each optic 1
Light colour/type White
Required components:
 C15083_LENA-STD-BASE-VERO29

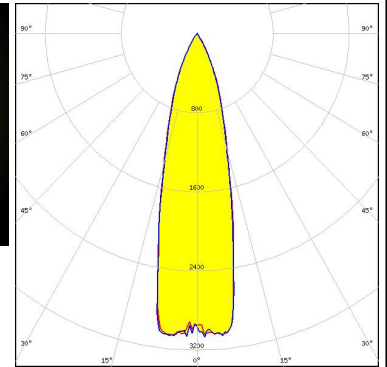
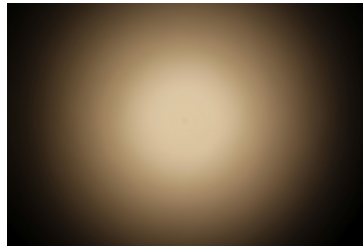

Light distribution files



LED VERO13
FWHM / FWTM 14.0° / 35.0°
Efficiency 83 %
Peak intensity 6.3 cd/lm
LEDs/each optic 1
Light colour/type White
Required components:
 C13868_LENA-STD-BASE-VERO13-18
 C11996_LENA-LENS

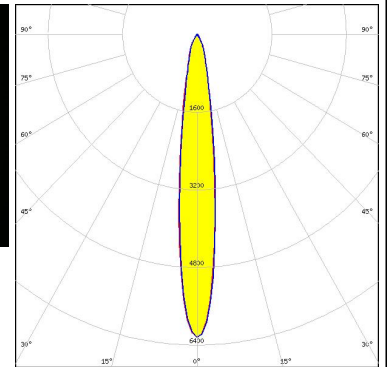

Light distribution files



LED VERO18
FWHM / FWTM 17.0° / 39.0°
Efficiency 83 %
Peak intensity 5.5 cd/lm
LEDs/each optic 1
Light colour/type White
Required components:
 C13868_LENA-STD-BASE-VERO13-18
 C11996_LENA-LENS

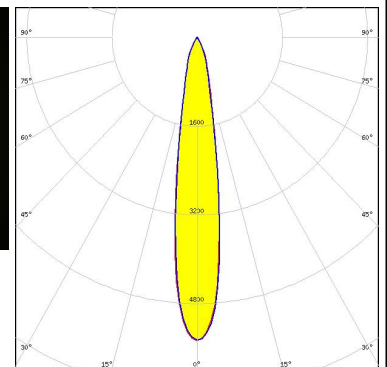

Light distribution files

OPTICAL RESULTS (MEASURED):

bridgelux

LED VERO29
FWHM / FWTM 30.0° / 56.0°
Efficiency 80 %
Peak intensity 2.3 cd/lm
LEDs/each optic 1
Light colour/type White
Required components:
C13867_LENA-STD-BASE-VERO29

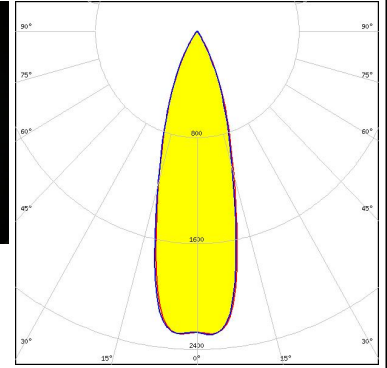

Light distribution files

CITIZEN

LED CL-L340
FWHM / FWTM 11.0° / 25.0°
Efficiency 84 %
Peak intensity 10.1 cd/lm
LEDs/each optic 1
Light colour/type White
Required components:
C11995_LENA-STD-BASE-CL340

CITIZEN

LED CL-L340
FWHM / FWTM 14.0° / 31.0°
Efficiency 79 %
Peak intensity 8 cd/lm
LEDs/each optic 1
Light colour/type White
Required components:
C11995_LENA-STD-BASE-CL340
C11996_LENA-LENS

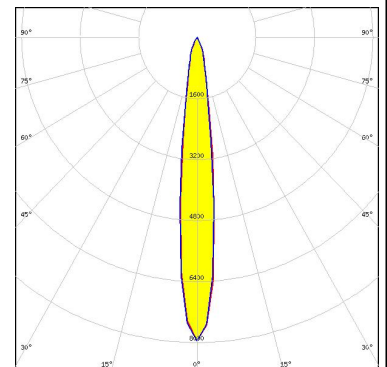

Light distribution files

OPTICAL RESULTS (MEASURED):

CITIZEN

LED CL-L340
 FWHM / FWTM 11.0° / 24.0°
 Efficiency 86 %
 Peak intensity 11.5 cd/lm
 LEDs/each optic 1
 Light colour/type White
 Required components:
 C11995_LENA-STD-BASE-CL340

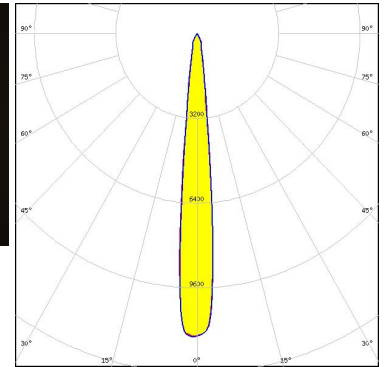

Light distribution files

CITIZEN

LED CLL02x/CLU02x (LES10)
 FWHM / FWTM 8.0° / 14.0°
 Efficiency 85 %
 Peak intensity 26.5 cd/lm
 LEDs/each optic 1
 Light colour/type White
 Required components:
 C13868_LENA-STD-BASE-VERO13-18
 Bender Wirth: 434 Typ L1

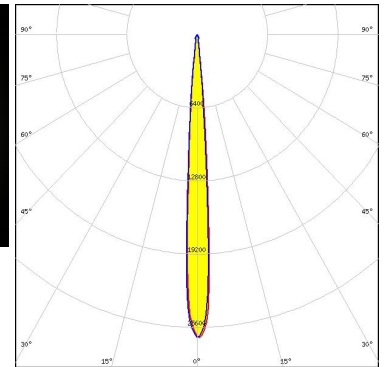

Light distribution files

CITIZEN

LED CLL02x/CLU02x (LES10)
 FWHM / FWTM 10.0° / 22.0°
 Efficiency 80 %
 Peak intensity 11.5 cd/lm
 LEDs/each optic 1
 Light colour/type White
 Required components:
 C13868_LENA-STD-BASE-VERO13-18
 C11996_LENA-LENS
 Bender Wirth: 434 Typ L1

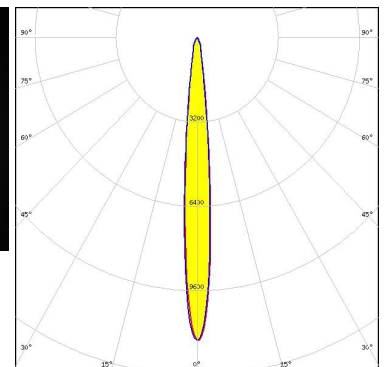

Light distribution files

OPTICAL RESULTS (MEASURED):

CITIZEN

LED CLL03x/CLU03x
 FWHM / FWTM 13.0° / 30.0°
 Efficiency 80 %
 Peak intensity 7.6 cd/lm
 LEDs/each optic 1
 Light colour/type White
 Required components:
 C12691_LENA-STD-BASE-CLL030
 C11996_LENA-LENS

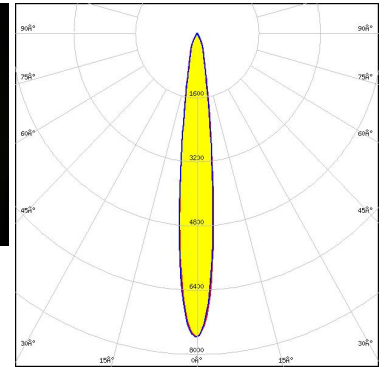

Light distribution files

CITIZEN

LED CLL03x/CLU03x
 FWHM / FWTM 13.0° / 34.0°
 Efficiency 78 %
 Peak intensity 6.4 cd/lm
 LEDs/each optic 1
 Light colour/type White
 Required components:
 A.A.G. STUCCHI: 8101-G2 + S-8000-11

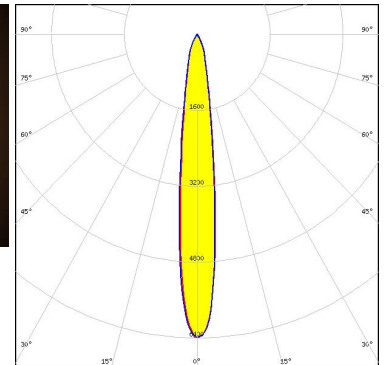
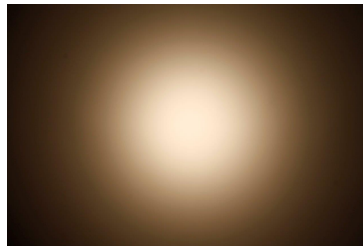

Light distribution files

CITIZEN

LED CLL03x/CLU03x
 FWHM / FWTM 14.0° / 32.0°
 Efficiency 80 %
 Peak intensity 6.7 cd/lm
 LEDs/each optic 1
 Light colour/type White
 Required components:
 C13868_LENA-STD-BASE-VERO13-18
 C11996_LENA-LENS
 Bender Wirth: 433 Typ L1

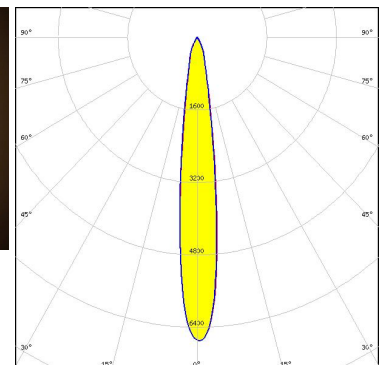
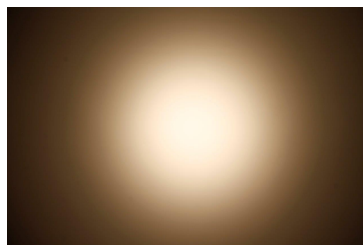

Light distribution files

OPTICAL RESULTS (MEASURED):

CITIZEN

LED CLL03x/CLU03x
FWHM / FWTM 11.0° / 22.0°
Efficiency 85 %
Peak intensity 13 cd/lm
LEDs/each optic 1
Light colour/type White
Required components:
C12691_LENA-STD-BASE-CLL030

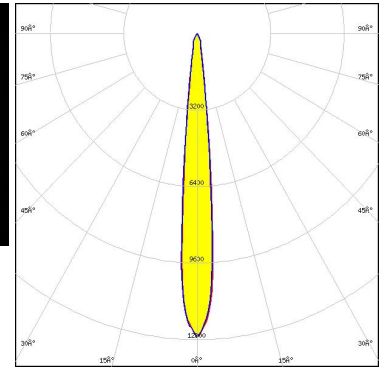

Light distribution files

CITIZEN

LED CLL04x/CLU04x
FWHM / FWTM 15.0° / 40.0°
Efficiency 84 %
Peak intensity 5.3 cd/lm
LEDs/each optic 1
Light colour/type White
Required components:
C12692_LENA-STD-BASE-CLL040



Light distribution files

CITIZEN

LED CLL04x/CLU04x
FWHM / FWTM 17.0° / 45.0°
Efficiency 78 %
Peak intensity 4.8 cd/lm
LEDs/each optic 1
Light colour/type White
Required components:
A.A.G. STUCCHI: 8102-G2 + S-8000-12

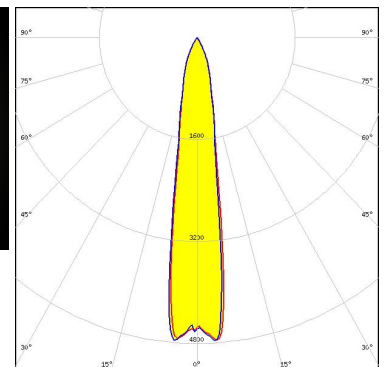
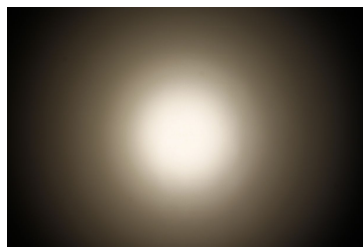

Light distribution files

OPTICAL RESULTS (MEASURED):

CITIZEN

LED CLL04x/CLU04x
 FWHM / FWTM 16.0° / 46.0°
 Efficiency 79 %
 Peak intensity 3.8 cd/lm
 LEDs/each optic 1
 Light colour/type White
 Required components:
 C12692_LENA-STD-BASE-CLL040
 C11996_LENA-LENS

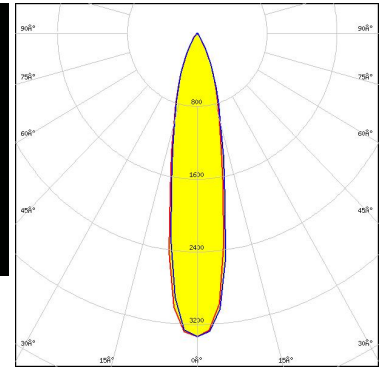

Light distribution files

CITIZEN

LED CLL04x/CLU04x
 FWHM / FWTM 21.0° / 51.0°
 Efficiency 80 %
 Peak intensity 3.4 cd/lm
 LEDs/each optic 1
 Light colour/type White
 Required components:
 C13867_LENA-STD-BASE-VERO29
 Bender Wirth: 431 Typ L3

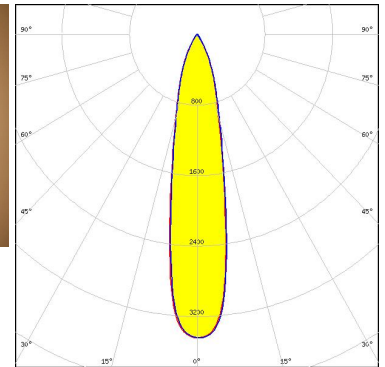
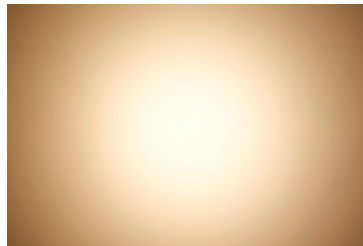

Light distribution files

CITIZEN

LED CLL04x/CLU04x
 FWHM / FWTM 19.0° / 51.0°
 Efficiency 81 %
 Peak intensity 3.6 cd/lm
 LEDs/each optic 1
 Light colour/type White
 Required components:
 IDEAL: 50-2204CT + 50-2100LN

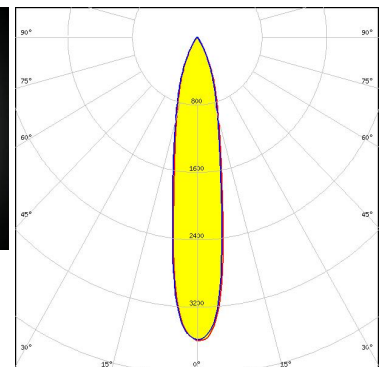
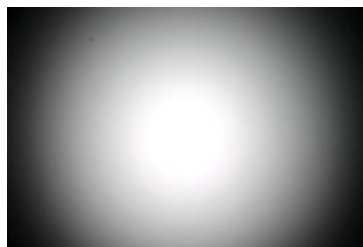

Light distribution files

OPTICAL RESULTS (MEASURED):

CITIZEN

LED CLL04x/CLU04x
 FWHM / FWTM 16.0° / 45.0°
 Efficiency 85 %
 Peak intensity 5.2 cd/lm
 LEDs/each optic 1
 Light colour/type White
 Required components:
 IDEAL: 50-2204CT + 50-2100LN

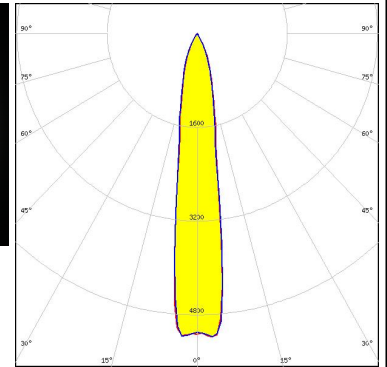

Light distribution files

CITIZEN

LED CLL04x/CLU04x
 FWHM / FWTM 23.0° / 56.0°
 Efficiency 73 %
 Peak intensity 2.5 cd/lm
 LEDs/each optic 1
 Light colour/type White
 Required components:
 A.A.G. STUCCHI: 8102-G2 + S-8000-12

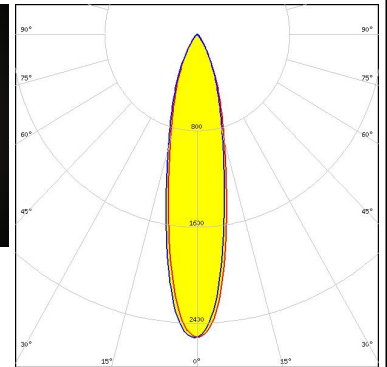
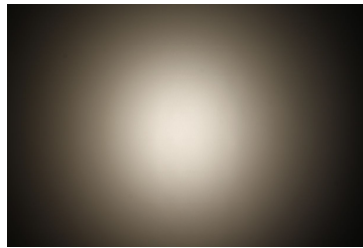

Light distribution files

CITIZEN

LED CLU700/701/702/703
 FWHM / FWTM 8.0° / 17.0°
 Efficiency 80 %
 Peak intensity 17.5 cd/lm
 LEDs/each optic 1
 Light colour/type White
 Required components:
 C13868_LENA-STD-BASE-VERO13-18
 C11996_LENA-LENS
 Bender Wirth: 434 Typ L1

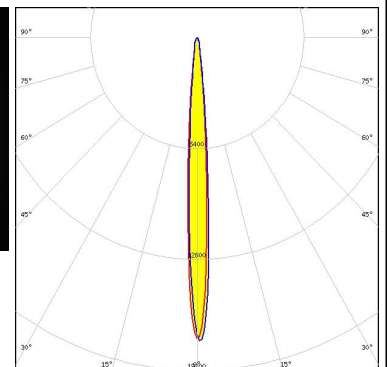

Light distribution files

OPTICAL RESULTS (MEASURED):

CITIZEN

LED CLU700/701/702/703
 FWHM / FWTM 5.0° / 9.0°
 Efficiency 87 %
 Peak intensity 61.4 cd/lm
 LEDs/each optic 1
 Light colour/type White
 Required components:
 C13868_LENA-STD-BASE-VERO13-18
 Bender Wirth: 434 Typ L1

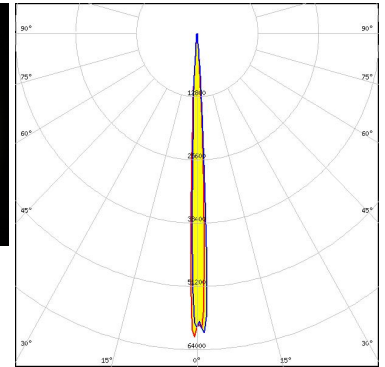

Light distribution files

CITIZEN

LED CLU710/711
 FWHM / FWTM 7.0° / 13.0°
 Efficiency 90 %
 Peak intensity 30 cd/lm
 LEDs/each optic 1
 Light colour/type White
 Required components:
 C12691_LENA-STD-BASE-CLL030

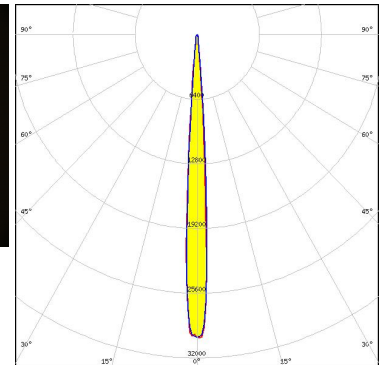

Light distribution files

CITIZEN

LED CLU710/711
 FWHM / FWTM 9.0° / 21.0°
 Efficiency 83 %
 Peak intensity 12 cd/lm
 LEDs/each optic 1
 Light colour/type White
 Required components:
 C12691_LENA-STD-BASE-CLL030
 C11996_LENA-LENS

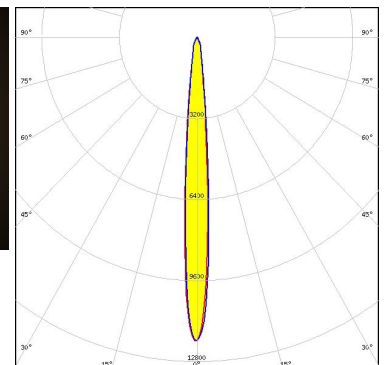
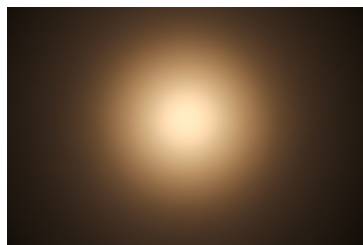

Light distribution files

OPTICAL RESULTS (MEASURED):

CITIZEN

LED CLU720/721/723
 FWHM / FWTM 9.0° / 16.0°
 Efficiency 85 %
 Peak intensity 18.7 cd/lm
 LEDs/each optic 1
 Light colour/type White
 Required components:
 C12691_LENA-STD-BASE-CLL030

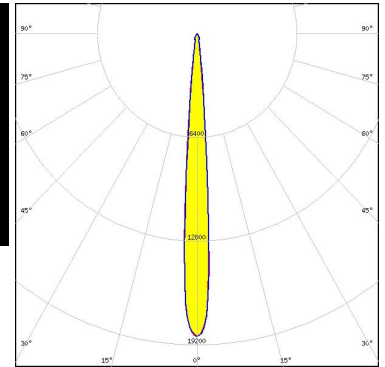

Light distribution files

CITIZEN

LED CLU720/721/723
 FWHM / FWTM 11.0° / 26.0°
 Efficiency 79 %
 Peak intensity 8.6 cd/lm
 LEDs/each optic 1
 Light colour/type White
 Required components:
 C12691_LENA-STD-BASE-CLL030
 C11996_LENA-LENS

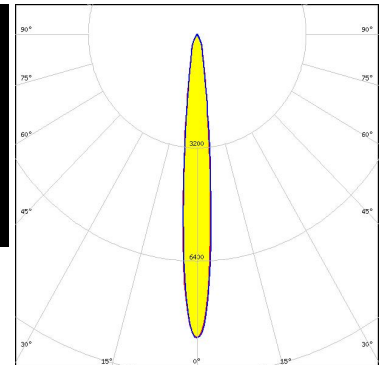
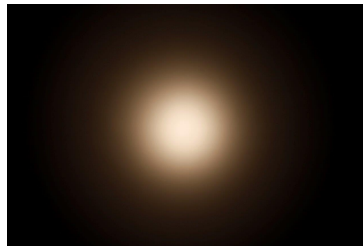

Light distribution files

CITIZEN

LED CLU730/731/733
 FWHM / FWTM 10.0° / 21.0°
 Efficiency 82 %
 Peak intensity 12.4 cd/lm
 LEDs/each optic 1
 Light colour/type White
 Required components:
 C12692_LENA-STD-BASE-CLL040

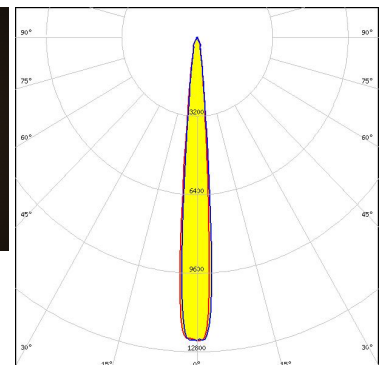
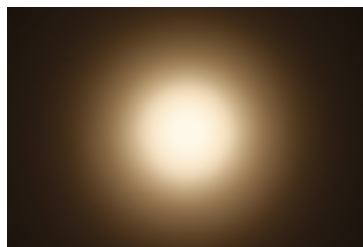

Light distribution files

OPTICAL RESULTS (MEASURED):



LED CMA1840
 FWHM / FWTM 11.0° / 25.0°
 Efficiency 88 %
 Peak intensity 12 cd/lm
 LEDs/each optic 1
 Light colour/type White
 Required components:
 C14146_LENA-STD-BASE-CXA18

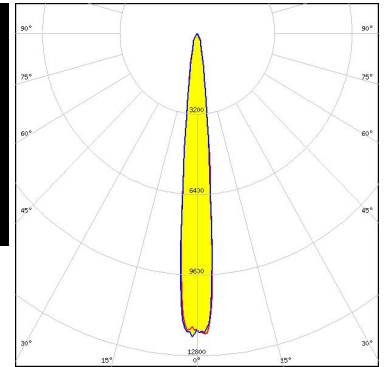

Light distribution files



LED CMA2550
 FWHM / FWTM 14.0° / 38.0°
 Efficiency 86 %
 Peak intensity 6.9 cd/lm
 LEDs/each optic 1
 Light colour/type White
 Required components:
 C13324_LENA-STD-BASE-CXA25

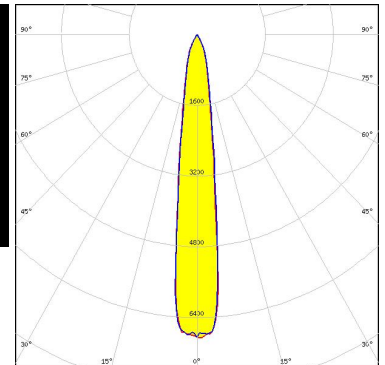
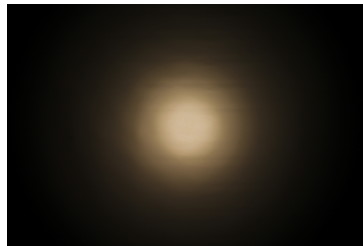

Light distribution files



LED CMT14xx
 FWHM / FWTM 8.0° / 15.0°
 Efficiency 88 %
 Peak intensity 24.1 cd/lm
 LEDs/each optic 1
 Light colour/type White
 Required components:
 C13868_LENA-STD-BASE-VERO13-18
 Bender Wirth: 434 Typ L1

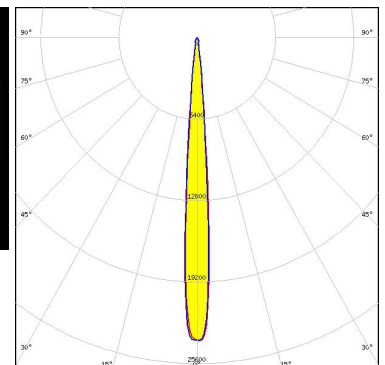

Light distribution files

OPTICAL RESULTS (MEASURED):



LED CMT19xx
 FWHM / FWTM 12.0° / 24.0°
 Efficiency 88 %
 Peak intensity 11.4 cd/lm
 LEDs/each optic 1
 Light colour/type White
 Required components:
 C12691_LENA-STD-BASE-CLL030

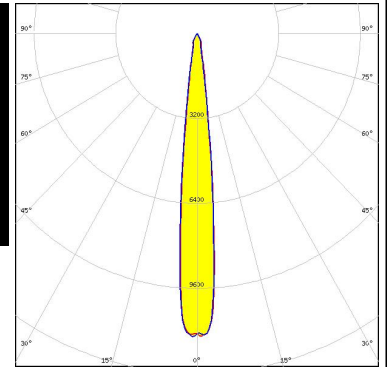
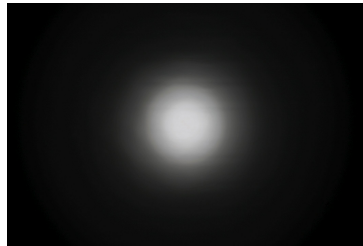

Light distribution files



LED CMT19xx
 FWHM / FWTM 12.0° / 24.0°
 Efficiency 87 %
 Peak intensity 11.3 cd/lm
 LEDs/each optic 1
 Light colour/type White
 Required components:
 C13868_LENA-STD-BASE-VERO13-18
 Bender Wirth: 477 Typ L1

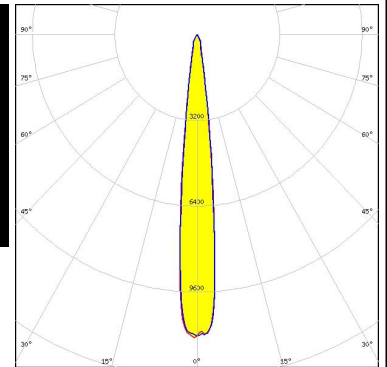

Light distribution files



LED CMT28xx
 FWHM / FWTM 19.0° / 45.0°
 Efficiency 87 %
 Peak intensity 5.1 cd/lm
 LEDs/each optic 1
 Light colour/type White
 Required components:
 C13867_LENA-STD-BASE-VERO29
 Bender Wirth: 471 Typ L3

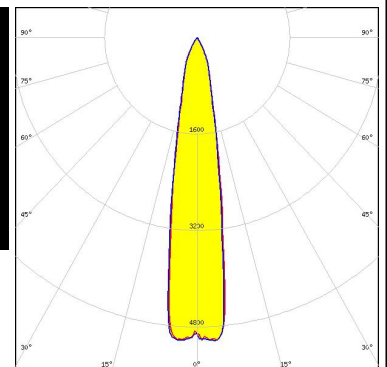
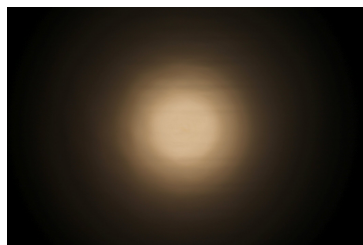

Light distribution files

OPTICAL RESULTS (MEASURED):



LED CMT28xx
 FWHM / FWTM 18.0° / 46.0°
 Efficiency 87 %
 Peak intensity 5.1 cd/lm
 LEDs/each optic 1
 Light colour/type White
 Required components:
 C12692_LENA-STD-BASE-CLL040

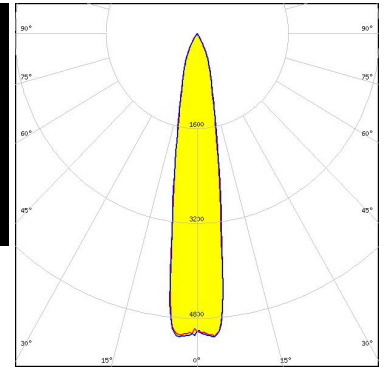
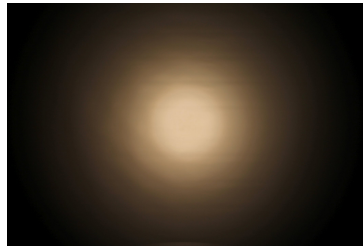

Light distribution files



LED CXA/B 15xx
 FWHM / FWTM 8.0° / 18.0°
 Efficiency 80 %
 Peak intensity 16.5 cd/lm
 LEDs/each optic 1
 Light colour/type White
 Required components:
 C13868_LENA-STD-BASE-VERO13-18
 C11996_LENA-LENS
 Bender Wirth: 441 Typ L1

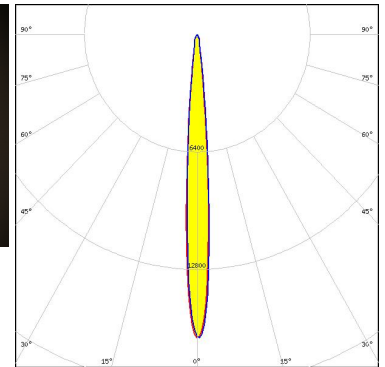

Light distribution files



LED CXA/B 15xx
 FWHM / FWTM 8.0° / 19.0°
 Efficiency 81 %
 Peak intensity 15.5 cd/lm
 LEDs/each optic 1
 Light colour/type White
 Required components:
 C13186_LENA-STD-BASE-CXA15
 C11996_LENA-LENS

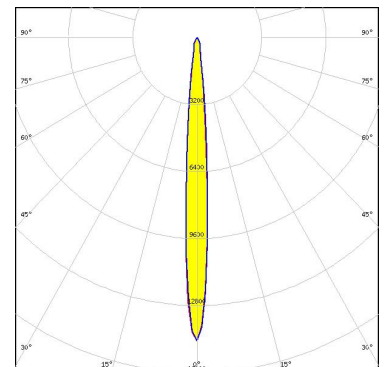

Light distribution files

OPTICAL RESULTS (MEASURED):



LED CXA/B 15xx
 FWHM / FWTM 7.0° / 13.0°
 Efficiency 86 %
 Peak intensity 31.3 cd/lm
 LEDs/each optic 1
 Light colour/type White

Required components:

C13868_LENA-STD-BASE-VERO13-18
 Bender Wirth: 441 Typ L1

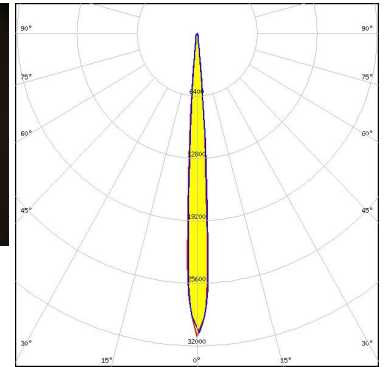

Light distribution files



LED CXA/B 15xx
 FWHM / FWTM 7.0° / 13.0°
 Efficiency 87 %
 Peak intensity 30.1 cd/lm
 LEDs/each optic 1
 Light colour/type White

Required components:

C13186_LENA-STD-BASE-CXA15

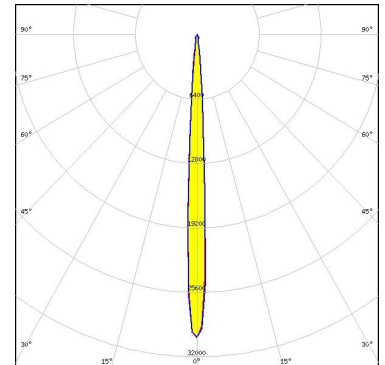

Light distribution files



LED CXA/B 1816 & CXA/B 1820 & CXA 1850
 FWHM / FWTM 12.0° / 28.0°
 Efficiency 82 %
 Peak intensity 8.6 cd/lm
 LEDs/each optic 1
 Light colour/type White

Required components:

C13868_LENA-STD-BASE-VERO13-18
 C11996_LENA-LENS
 Bender Wirth: 437 Typ L1

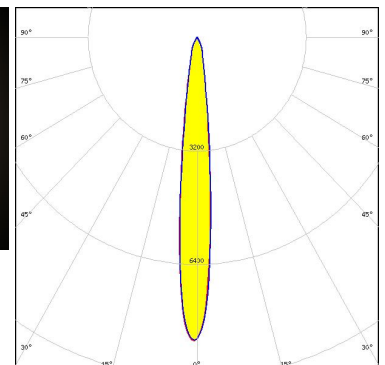
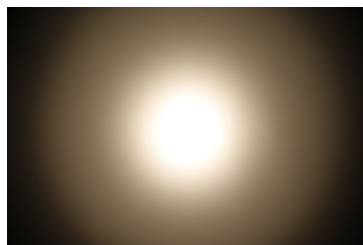

Light distribution files

OPTICAL RESULTS (MEASURED):



LED CXA/B 1816 & CXA/B 1820 & CXA 1850
 FWHM / FWTM 10.0° / 18.0°
 Efficiency 87 %
 Peak intensity 17.6 cd/lm
 LEDs/each optic 1
 Light colour/type White
 Required components:
 C13868_LENA-STD-BASE-VERO13-18
 Bender Wirth: 437 Typ L1

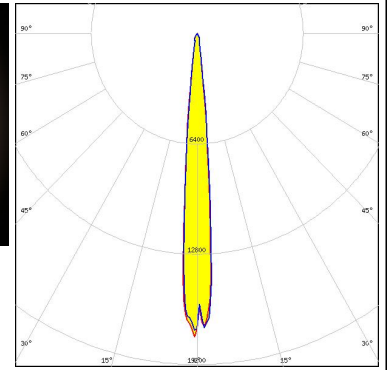

Light distribution files



LED CXA/B 1830
 FWHM / FWTM 12.0° / 23.0°
 Efficiency 87 %
 Peak intensity 11.9 cd/lm
 LEDs/each optic 1
 Light colour/type White
 Required components:
 C13868_LENA-STD-BASE-VERO13-18
 Bender Wirth: 437 Typ L1

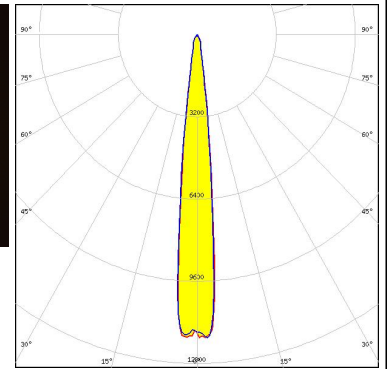
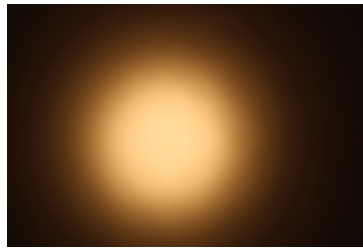

Light distribution files



LED CXA/B 1830
 FWHM / FWTM 12.0° / 23.0°
 Efficiency 82 %
 Peak intensity 10.3 cd/lm
 LEDs/each optic 1
 Light colour/type White
 Required components:
 C13868_LENA-STD-BASE-VERO13-18
 C14169_LENA-CLEAR-LENS
 Bender Wirth: 437 Typ L1

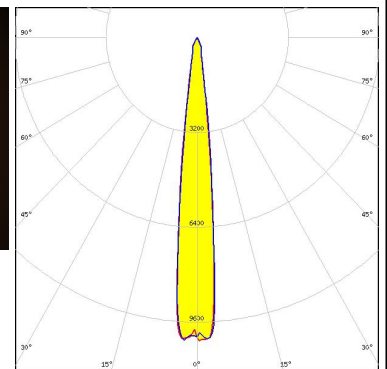

Light distribution files

OPTICAL RESULTS (MEASURED):



LED CXA/B 1830
 FWHM / FWTM 18.0° / 60.0°
 Efficiency 75 %
 Peak intensity 2.3 cd/lm
 LEDs/each optic 1
 Light colour/type White

Required components:

C13868_LENA-STD-BASE-VERO13-18

C12231_LENA-FRESNEL

Bender Wirth: 437 Typ L1

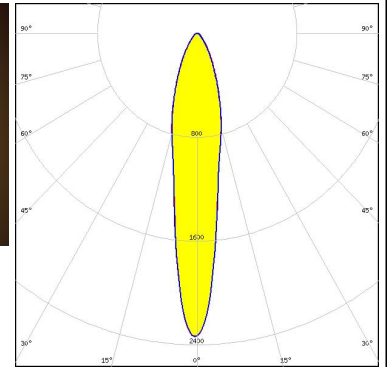
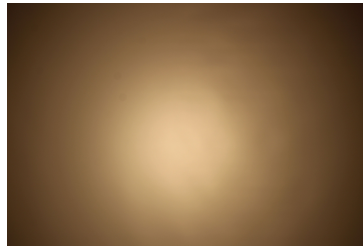

Light distribution files



LED CXA/B 25xx
 FWHM / FWTM 13.0° / 39.0°
 Efficiency 79 %
 Peak intensity 5.9 cd/lm
 LEDs/each optic 1
 Light colour/type White

Required components:

C13324_LENA-STD-BASE-CXA25

C11996_LENA-LENS

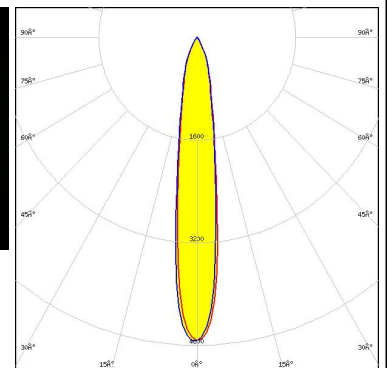

Light distribution files



LED CXA/B 25xx
 FWHM / FWTM 13.0° / 33.0°
 Efficiency 84 %
 Peak intensity 8 cd/lm
 LEDs/each optic 1
 Light colour/type White

Required components:

C13324_LENA-STD-BASE-CXA25

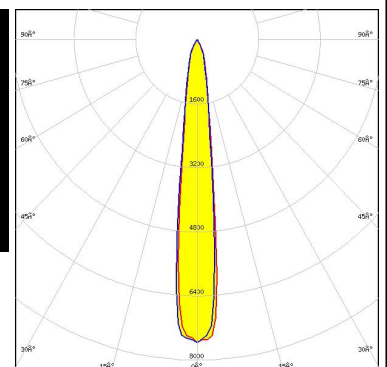

Light distribution files

OPTICAL RESULTS (MEASURED):



LED CXA2011
FWHM / FWTM 11.0°
Efficiency 80 %
LEDs/each optic 1
Light colour/type White
Required components:
C12105_LENA-STD-BASE-CXA20
C11996_LENA-LENS

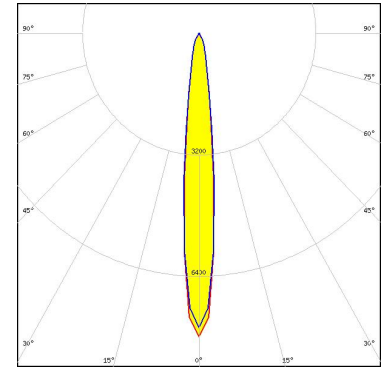

Light distribution files



LED CHI3030 19W
FWHM / FWTM 20.0° / 50.0°
Efficiency 86 %
Peak intensity 4.1 cd/lm
LEDs/each optic 1
Light colour/type White
Required components:
C13867_LENA-STD-BASE-VERO29
Bender Wirth: 468 Typ L3

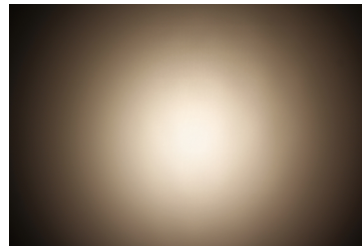

Light distribution files



LED CHI3030 29W
FWHM / FWTM 25.0° / 57.0°
Efficiency 80 %
Peak intensity 2.7 cd/lm
LEDs/each optic 1
Light colour/type White
Required components:
C13867_LENA-STD-BASE-VERO29
Bender Wirth: 468 Typ L3

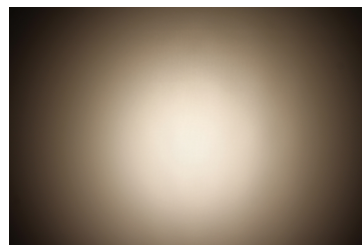

Light distribution files

OPTICAL RESULTS (MEASURED):



LED LUXEON CoB 1202/1203
 FWHM / FWTM 7.0° / 14.0°
 Efficiency 87 %
 Peak intensity 28.3 cd/lm
 LEDs/each optic 1
 Light colour/type White
 Required components:
 C13868_LENA-STD-BASE-VERO13-18
 Bender Wirth: 438 Typ L1

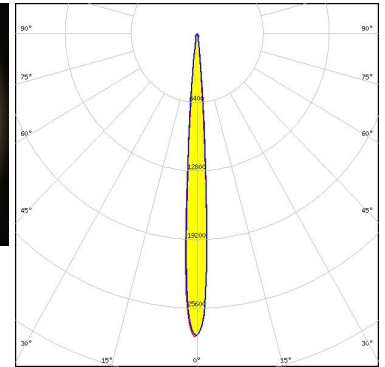

Light distribution files



LED LUXEON CoB 1204/1205
 FWHM / FWTM 10.0° / 21.0°
 Efficiency 83 %
 Peak intensity 13.1 cd/lm
 LEDs/each optic 1
 Light colour/type White
 Required components:
 C12292_LENA-STD-BASE-MEZ

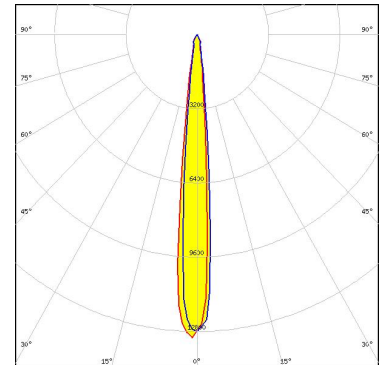

Light distribution files



LED LUXEON CoB 1204/1205
 FWHM / FWTM 12.0° / 30.0°
 Efficiency 77 %
 Peak intensity 7.3 cd/lm
 LEDs/each optic 1
 Light colour/type White
 Required components:
 C12292_LENA-STD-BASE-MEZ
 C11996_LENA-LENS

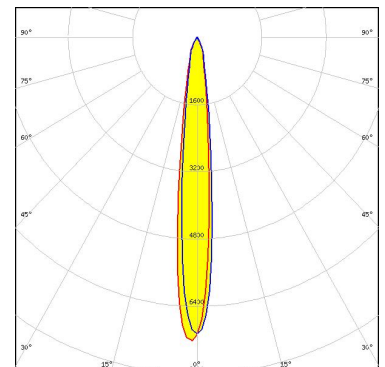

Light distribution files

OPTICAL RESULTS (MEASURED):



LED LUXEON CoB 1204HD
 FWHM / FWTM 7.5° / 14.0°
 Efficiency 88 %
 Peak intensity 28.8 cd/lm
 LEDs/each optic 1
 Light colour/type White
 Required components:
 C11981_LENA-STD-BASE-COB-L110

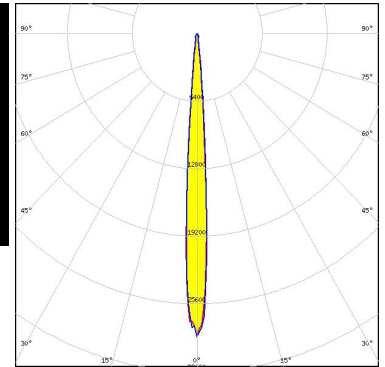

Light distribution files



LED LUXEON CoB 1205HD
 FWHM / FWTM 9.0° / 17.0°
 Efficiency 88 %
 Peak intensity 19.2 cd/lm
 LEDs/each optic 1
 Light colour/type White
 Required components:
 C11981_LENA-STD-BASE-COB-L110

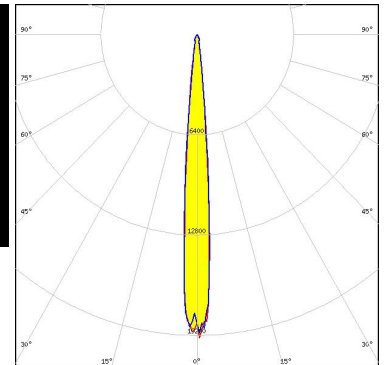

Light distribution files



LED LUXEON CoB 1208
 FWHM / FWTM 14.0° / 35.0°
 Efficiency 78 %
 Peak intensity 6 cd/lm
 LEDs/each optic 1
 Light colour/type White
 Required components:
 C12292_LENA-STD-BASE-MEZ
 C11996_LENA-LENS

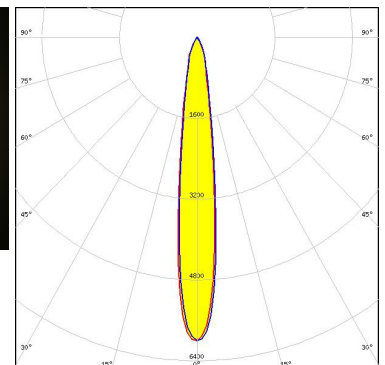

Light distribution files

OPTICAL RESULTS (MEASURED):



LED LUXEON CoB 1208
FWHM / FWTM 12.0° / 25.0°
Efficiency 84 %
Peak intensity 9.9 cd/lm
LEDs/each optic 1
Light colour/type White
Required components:
C12292_LENA-STD-BASE-MEZ

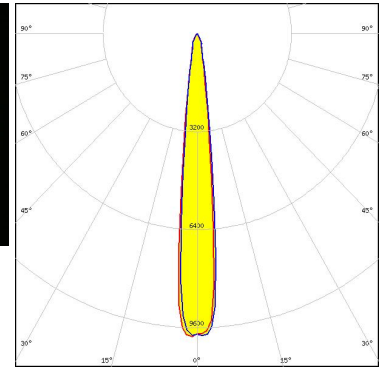
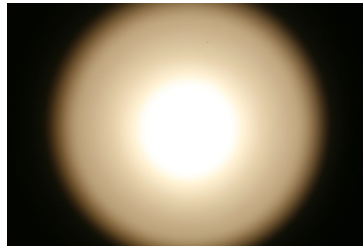

Light distribution files



LED LUXEON CoB 1211
FWHM / FWTM 17.0° / 42.0°
Efficiency 80 %
Peak intensity 5 cd/lm
LEDs/each optic 1
Light colour/type White
Required components:
C13867_LENA-STD-BASE-VERO29
Bender Wirth: 431 Typ L3

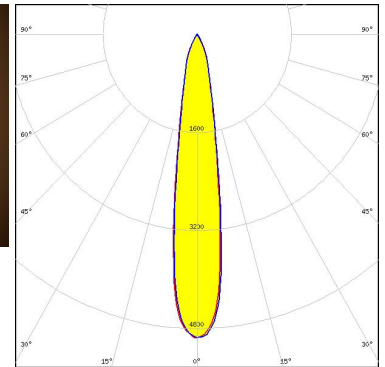
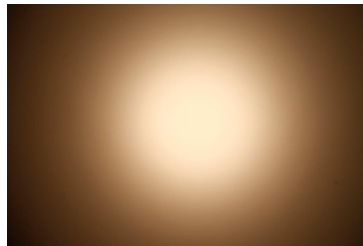

Light distribution files



LED LUXEON CoB 1211
FWHM / FWTM 16.0° / 35.0°
Efficiency 85 %
Peak intensity 6.6 cd/lm
LEDs/each optic 1
Light colour/type White
Required components:
C13867_LENA-STD-BASE-VERO29
Bender Wirth: 431 Typ L3

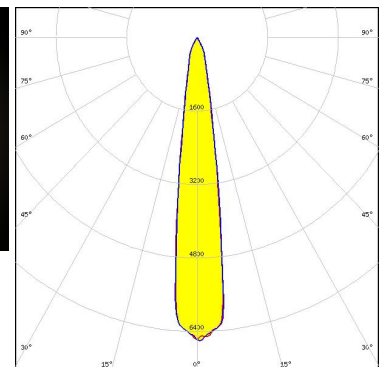
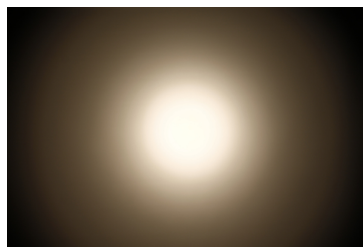

Light distribution files

OPTICAL RESULTS (MEASURED):



LED LUXEON CoB 1213/1216/1812
 FWHM / FWTM 23.0° / 56.0°
 Efficiency 74 %
 Peak intensity 2.6 cd/lm
 LEDs/each optic 1
 Light colour/type White
 Required components:
 A.A.G. STUCCHI: 8102-G2 + S-8000-12

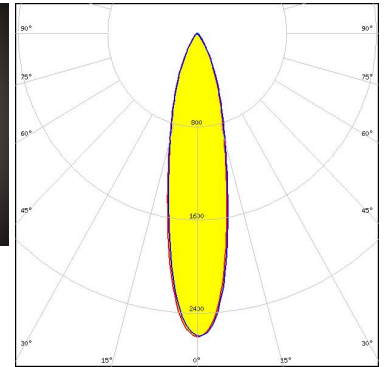
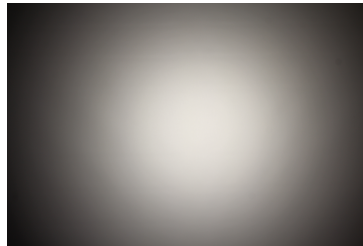

Light distribution files



LED LUXEON CoB 1213/1216/1812
 FWHM / FWTM 21.0° / 50.0°
 Efficiency 80 %
 Peak intensity 3.6 cd/lm
 LEDs/each optic 1
 Light colour/type White
 Required components:
 C12692_LENA-STD-BASE-CLL040
 C11996_LENA-LENS

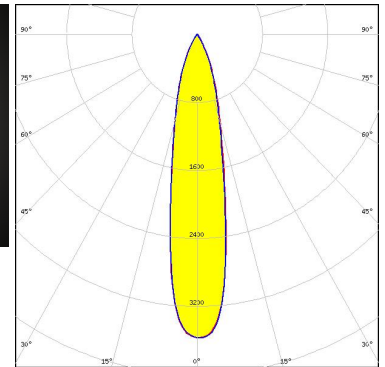
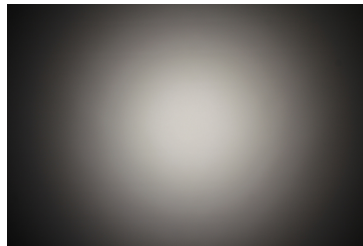

Light distribution files



LED LUXEON CoB 1213/1216/1812
 FWHM / FWTM 18.0° / 47.0°
 Efficiency 79 %
 Peak intensity 4.5 cd/lm
 LEDs/each optic 1
 Light colour/type White
 Required components:
 A.A.G. STUCCHI: 8102-G2 + S-8000-12

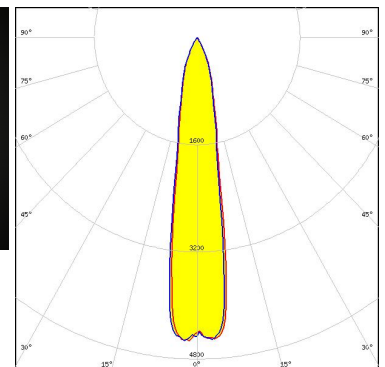
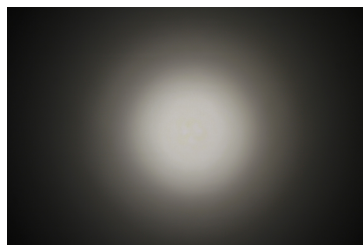

Light distribution files

OPTICAL RESULTS (MEASURED):



LED CDM-14 (Dim-To-Warm)
FWHM / FWTM 13.0° / 28.0°
Efficiency 82 %
Peak intensity 8.5 cd/lm
LEDs/each optic 1
Light colour/type White
Required components:
 C13868_LENA-STD-BASE-VERO13-18
 C11996_LENA-LENS
 Bender Wirth: 491 Typ L2

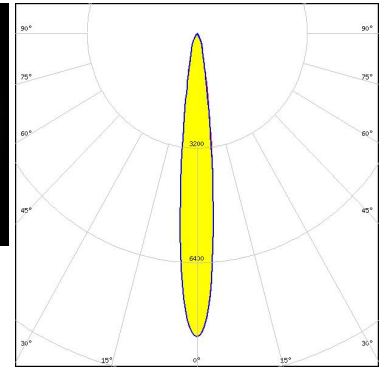

Light distribution files



LED CDM-18 (Dim-To-Warm)
FWHM / FWTM 16.0° / 38.0°
Efficiency 82 %
Peak intensity 5.6 cd/lm
LEDs/each optic 1
Light colour/type White
Required components:
 C13868_LENA-STD-BASE-VERO13-18
 C11996_LENA-LENS
 Bender Wirth: 491 Typ L2

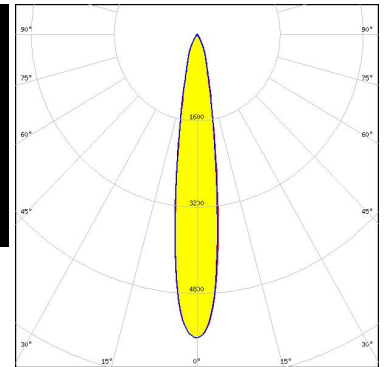

Light distribution files



LED CDM-9 (Dim-To-Warm)
FWHM / FWTM 10.0° / 21.0°
Efficiency 81 %
Peak intensity 13.4 cd/lm
LEDs/each optic 1
Light colour/type White
Required components:
 C13868_LENA-STD-BASE-VERO13-18
 C11996_LENA-LENS
 Bender Wirth: 490 Typ L1

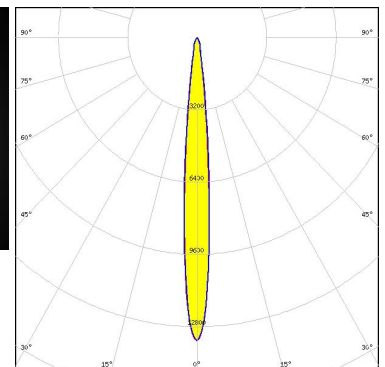

Light distribution files

OPTICAL RESULTS (MEASURED):



LED CTM-14 (Tunable White)
FWHM / FWTM 13.0° / 28.0°
Efficiency 81 %
Peak intensity 8.6 cd/lm
LEDs/each optic 1
Light colour/type White
Required components:
 C13867_LENA-STD-BASE-VERO29
 C12606_LENINA-DL
 Bender Wirth: 442 Typ L3

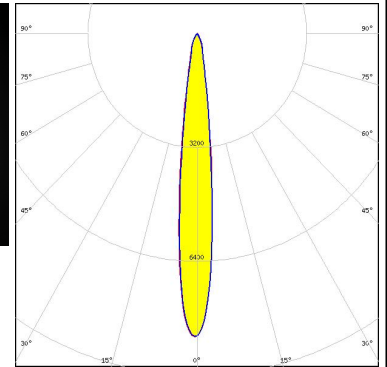

Light distribution files



LED CTM-14 (Tunable White)
FWHM / FWTM 10.0° / 20.0°
Efficiency 86 %
Peak intensity 14.9 cd/lm
LEDs/each optic 1
Light colour/type White
Required components:
 C13867_LENA-STD-BASE-VERO29
 Bender Wirth: 442 Typ L3

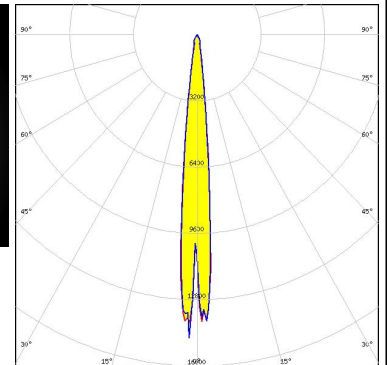

Light distribution files



LED CTM-18 (Tunable White)
FWHM / FWTM 15.0° / 36.0°
Efficiency 81 %
Peak intensity 6 cd/lm
LEDs/each optic 1
Light colour/type White
Required components:
 C13867_LENA-STD-BASE-VERO29
 C11996_LENA-LENS
 Bender Wirth: 442 Typ L3

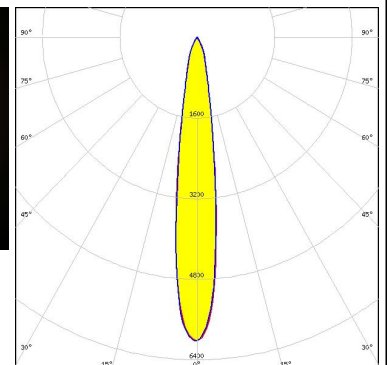
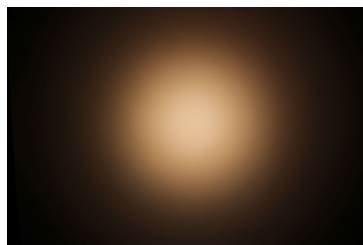

Light distribution files

OPTICAL RESULTS (MEASURED):



LED CTM-22 (Tunable White)
FWHM / FWTM 20.0° / 48.0°
Efficiency 81 %
Peak intensity 4 cd/lm
LEDs/each optic 1
Light colour/type White

Required components:

C13867_LENA-STD-BASE-VERO29

C11996_LENA-LENS

Bender Wirth: 494 Typ L3

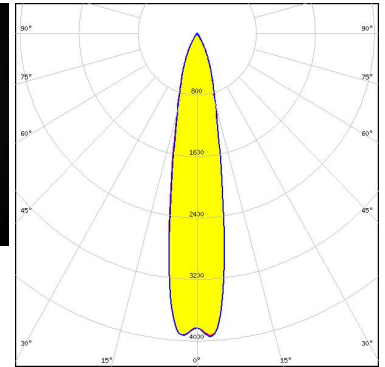
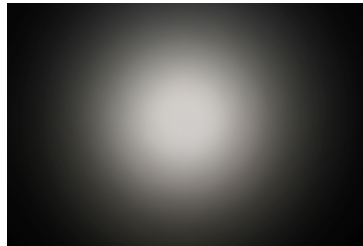

Light distribution files



LED CxM-14 (19x19)
FWHM / FWTM 14.0° / 33.0°
Efficiency 80 %
Peak intensity 7.1 cd/lm
LEDs/each optic 1
Light colour/type White

Required components:

C12691_LENA-STD-BASE-CLL030

C11996_LENA-LENS

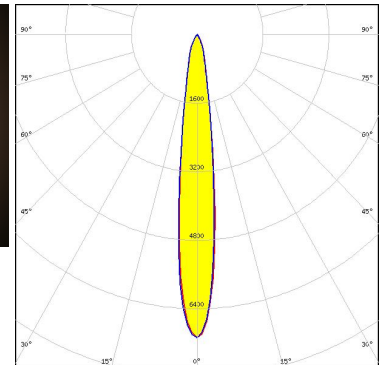

Light distribution files



LED CxM-22 (28x28)
FWHM / FWTM 21.0° / 52.0°
Efficiency 80 %
Peak intensity 3.8 cd/lm
LEDs/each optic 1
Light colour/type White

Required components:

C12692_LENA-STD-BASE-CLL040

C11996_LENA-LENS

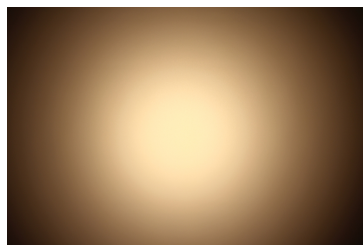

Light distribution files

OPTICAL RESULTS (MEASURED):



LED COB J-Type
 FWHM / FWTM 14.0° / 34.0°
 Efficiency 82 %
 Peak intensity 6.5 cd/lm
 LEDs/each optic 1
 Light colour/type White

Required components:

C13868_LENA-STD-BASE-VERO13-18

C11996_LENA-LENS

Bender Wirth: 463 Typ L2

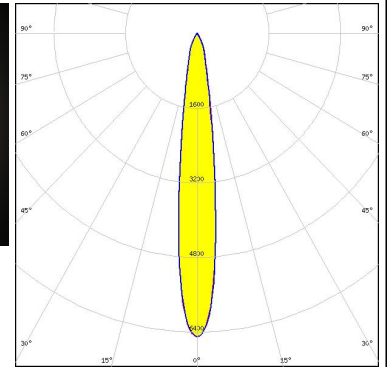

Light distribution files



LED COB J-Type
 FWHM / FWTM 12.0° / 24.0°
 Efficiency 87 %
 Peak intensity 11.6 cd/lm
 LEDs/each optic 1
 Light colour/type White

Required components:

C13868_LENA-STD-BASE-VERO13-18

Bender Wirth: 463 Typ L2

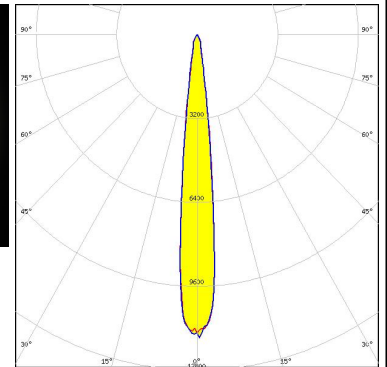

Light distribution files



LED COB L-Type (LES 11)
 FWHM / FWTM 9.0° / 17.0°
 Efficiency 87 %
 Peak intensity 18.8 cd/lm
 LEDs/each optic 1
 Light colour/type White

Required components:

C13868_LENA-STD-BASE-VERO13-18

Bender Wirth: 438 Typ L1

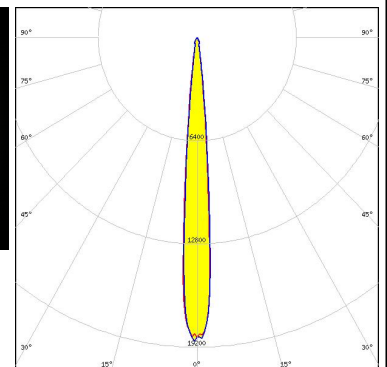

Light distribution files

OPTICAL RESULTS (MEASURED):



LED COB L-Type (LES 11)
FWHM / FWTM 11.0° / 26.0°
Efficiency 82 %
Peak intensity 9.4 cd/lm
LEDs/each optic 1
Light colour/type White
Required components:
 C13868_LENA-STD-BASE-VERO13-18
 C11996_LENA-LENS
 Bender Wirth: 438 Typ L1

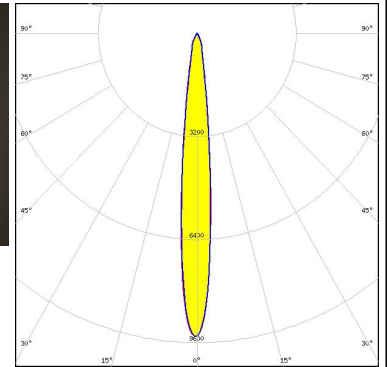

Light distribution files



LED COB L-Type (LES 9)
FWHM / FWTM 9.0° / 22.0°
Efficiency 83 %
Peak intensity 11.9 cd/lm
LEDs/each optic 1
Light colour/type White
Required components:
 C13868_LENA-STD-BASE-VERO13-18
 C11996_LENA-LENS
 Bender Wirth: 438 Typ L1

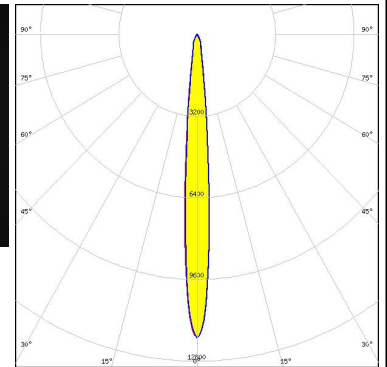

Light distribution files



LED COB L-Type (LES 9)
FWHM / FWTM 7.0° / 13.0°
Efficiency 89 %
Peak intensity 30.7 cd/lm
LEDs/each optic 1
Light colour/type White
Required components:
 C13868_LENA-STD-BASE-VERO13-18
 Bender Wirth: 438 Typ L1

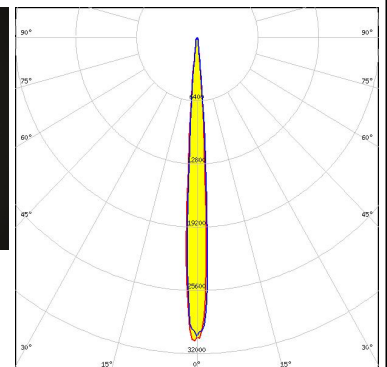

Light distribution files

OPTICAL RESULTS (MEASURED):



LED NVCWJ024Z-V1MT: COB J-Type Tunable White
 FWHM / FWTM 11.0° / 25.0°
 Efficiency 81 %
 Peak intensity 10 cd/lm
 LEDs/each optic 1
 Light colour/type White
 Required components:
 C13868_LENA-STD-BASE-VERO13-18
 C11996_LENA-LENS
 Bender Wirth: 498 Typ L2

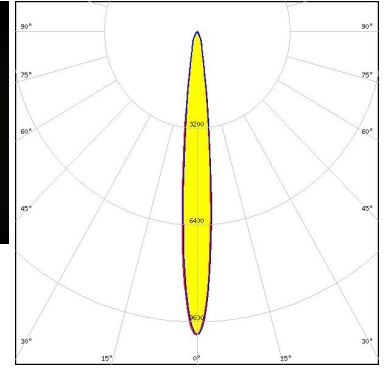

Light distribution files



LED NVCWJ024Z-V1MT: COB J-Type Tunable White
 FWHM / FWTM 9.0° / 16.0°
 Efficiency 87 %
 Peak intensity 21.5 cd/lm
 LEDs/each optic 1
 Light colour/type White
 Required components:
 C13868_LENA-STD-BASE-VERO13-18
 Bender Wirth: 498 Typ L2

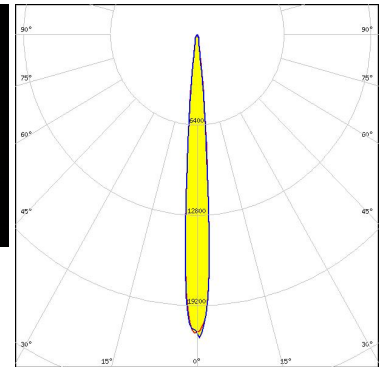

Light distribution files



LED Soleriq S13
 FWHM / FWTM 12.0° / 30.0°
 Efficiency 80 %
 Peak intensity 8 cd/lm
 LEDs/each optic 1
 Light colour/type White
 Required components:
 C13868_LENA-STD-BASE-VERO13-18
 C11996_LENA-LENS
 Bender Wirth: 437 Typ L1

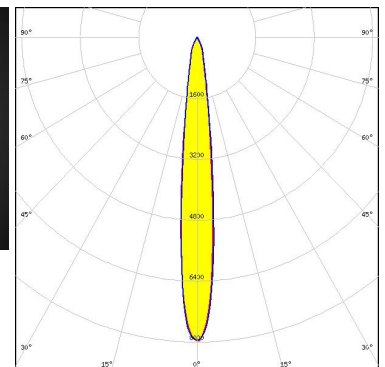
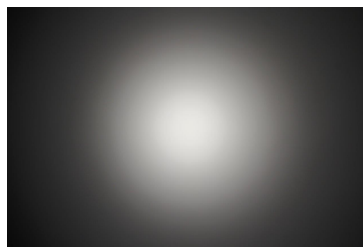

Light distribution files

OPTICAL RESULTS (MEASURED):

OSRAM
Opto Semiconductors

LED Soleriq S19
FWHM / FWTM 15.0° / 35.0°
Efficiency 80 %
Peak intensity 6.1 cd/lm
LEDs/each optic 1
Light colour/type White

Required components:

C13867_LENA-STD-BASE-VERO29
Bender Wirth: 462 Typ L3

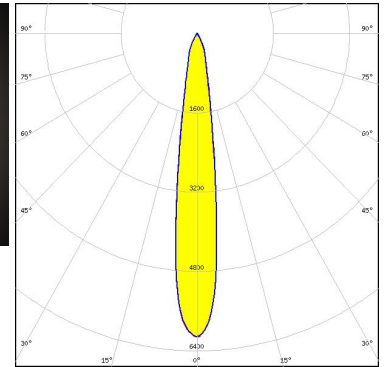
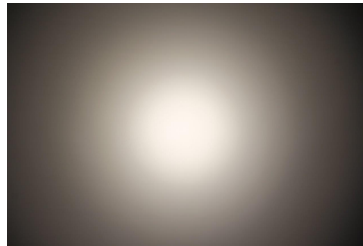

Light distribution files

PHILIPS

LED Fortimo SLM L13 CoB
FWHM / FWTM 10.0° / 21.0°
Efficiency 87 %
Peak intensity 14.4 cd/lm
LEDs/each optic 1
Light colour/type White

Required components:

C12292_LENA-STD-BASE-MEZ

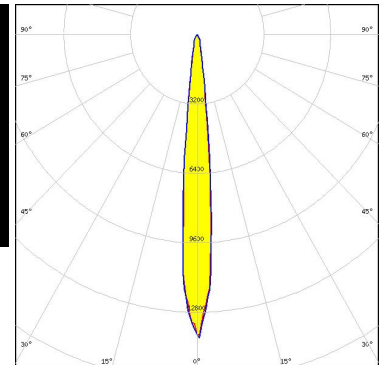

Light distribution files

PHILIPS

LED Fortimo SLM L13 CoB
FWHM / FWTM 11.0° / 25.0°
Efficiency 81 %
Peak intensity 9.9 cd/lm
LEDs/each optic 1
Light colour/type White

Required components:

C12292_LENA-STD-BASE-MEZ
C11996_LENA-LENS

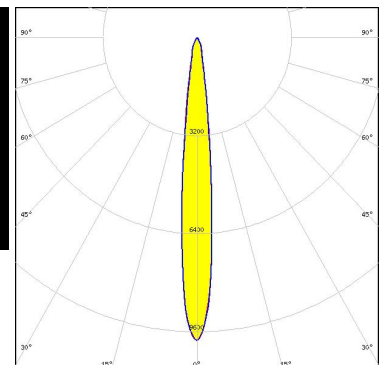
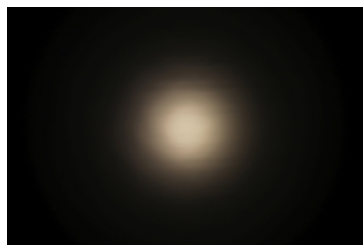

Light distribution files

OPTICAL RESULTS (MEASURED):

PHILIPS

LED Fortimo SLM L15 CoB
 FWHM / FWTM 13.0° / 26.0°
 Efficiency 87 %
 Peak intensity 10.6 cd/lm
 LEDs/each optic 1
 Light colour/type White
 Required components:
 C12292_LENA-STD-BASE-MEZ

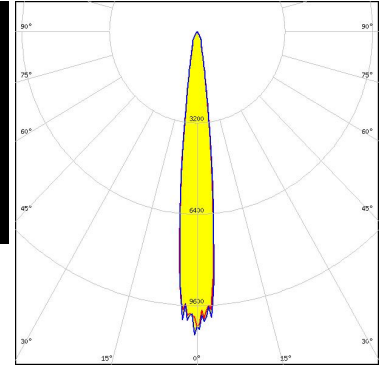

Light distribution files

PHILIPS

LED Fortimo SLM L15 CoB
 FWHM / FWTM 14.0° / 31.0°
 Efficiency 81 %
 Peak intensity 7.4 cd/lm
 LEDs/each optic 1
 Light colour/type White
 Required components:
 C12292_LENA-STD-BASE-MEZ
 C11996_LENA-LENS

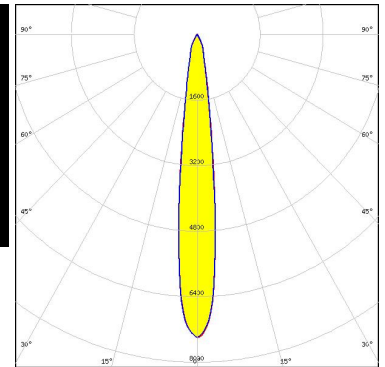
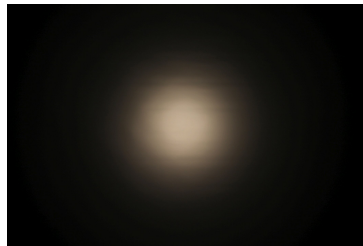

Light distribution files

PHILIPS

LED Fortimo SLM L19 CoB
 FWHM / FWTM 15.0° / 38.0°
 Efficiency 87 %
 Peak intensity 6.8 cd/lm
 LEDs/each optic 1
 Light colour/type White
 Required components:
 C12692_LENA-STD-BASE-CLL040

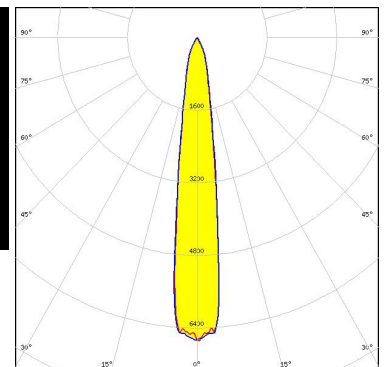
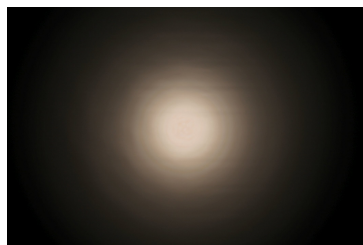

Light distribution files

OPTICAL RESULTS (MEASURED):

PHILIPS

LED Fortimo SLM L19 CoB
FWHM / FWTM 16.0° / 43.0°
Efficiency 81 %
Peak intensity 5.1 cd/lm
LEDs/each optic 1
Light colour/type White
Required components:
C12692_LENA-STD-BASE-CLL040
C11996_LENA-LENS

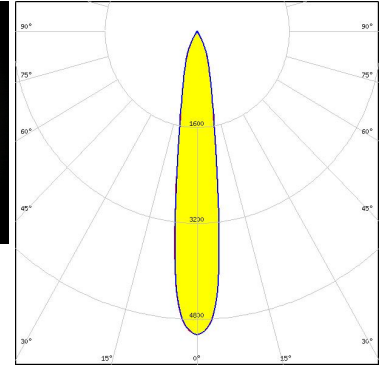

Light distribution files

PHILIPS

LED Fortimo SLM L23 CoB
FWHM / FWTM 19.0° / 47.0°
Efficiency 87 %
Peak intensity 4.8 cd/lm
LEDs/each optic 1
Light colour/type White
Required components:
C12692_LENA-STD-BASE-CLL040

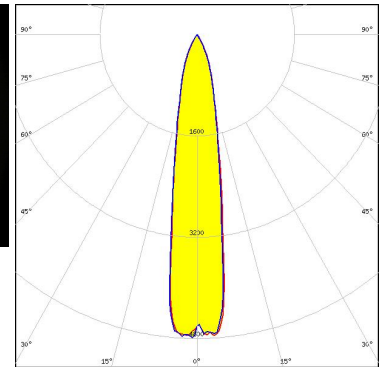
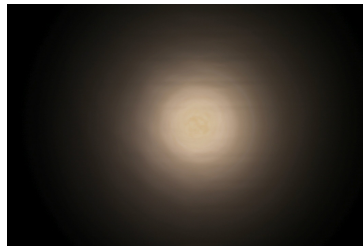

Light distribution files

PHILIPS

LED Fortimo SLM L23 CoB
FWHM / FWTM 20.0° / 50.0°
Efficiency 81 %
Peak intensity 3.8 cd/lm
LEDs/each optic 1
Light colour/type White
Required components:
C12692_LENA-STD-BASE-CLL040
C11996_LENA-LENS

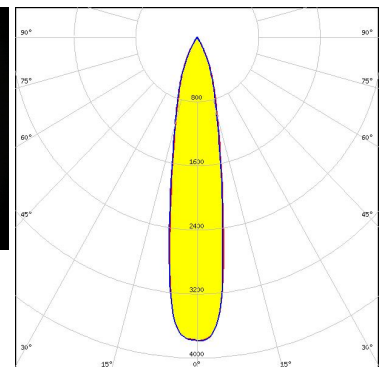
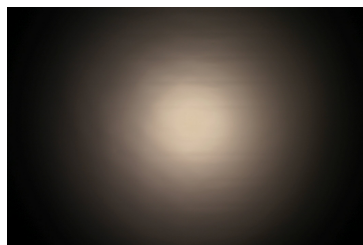

Light distribution files

OPTICAL RESULTS (MEASURED):

SAMSUNG

LED LC016D / LC019D / LC026D / LC033D
 FWHM / FWTM 14.0° / 32.0°
 Efficiency 80 %
 Peak intensity 6.9 cd/lm
 LEDs/each optic 1
 Light colour/type White
 Required components:
 C12691_LENA-STD-BASE-CLL030
 C11996_LENA-LENS

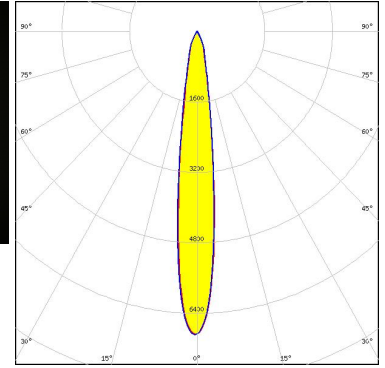

Light distribution files

SAMSUNG

LED LC016D / LC019D / LC026D / LC033D
 FWHM / FWTM 12.0° / 24.0°
 Efficiency 85 %
 Peak intensity 11 cd/lm
 LEDs/each optic 1
 Light colour/type White
 Required components:
 C12691_LENA-STD-BASE-CLL030

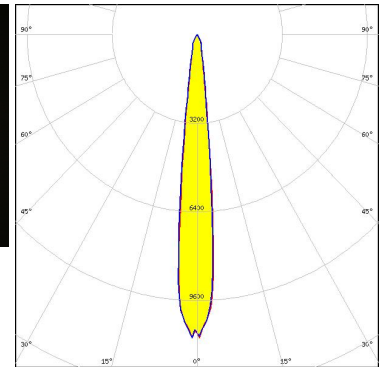

Light distribution files

SAMSUNG

LED LC040D / LC060D / LC080D
 FWHM / FWTM 22.0° / 52.0°
 Efficiency 80 %
 Peak intensity 3.3 cd/lm
 LEDs/each optic 1
 Light colour/type White
 Required components:
 C12692_LENA-STD-BASE-CLL040
 C11996_LENA-LENS

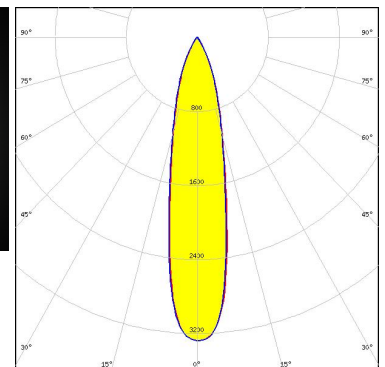
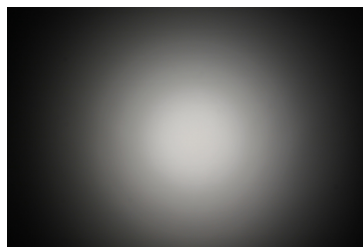

Light distribution files

OPTICAL RESULTS (MEASURED):

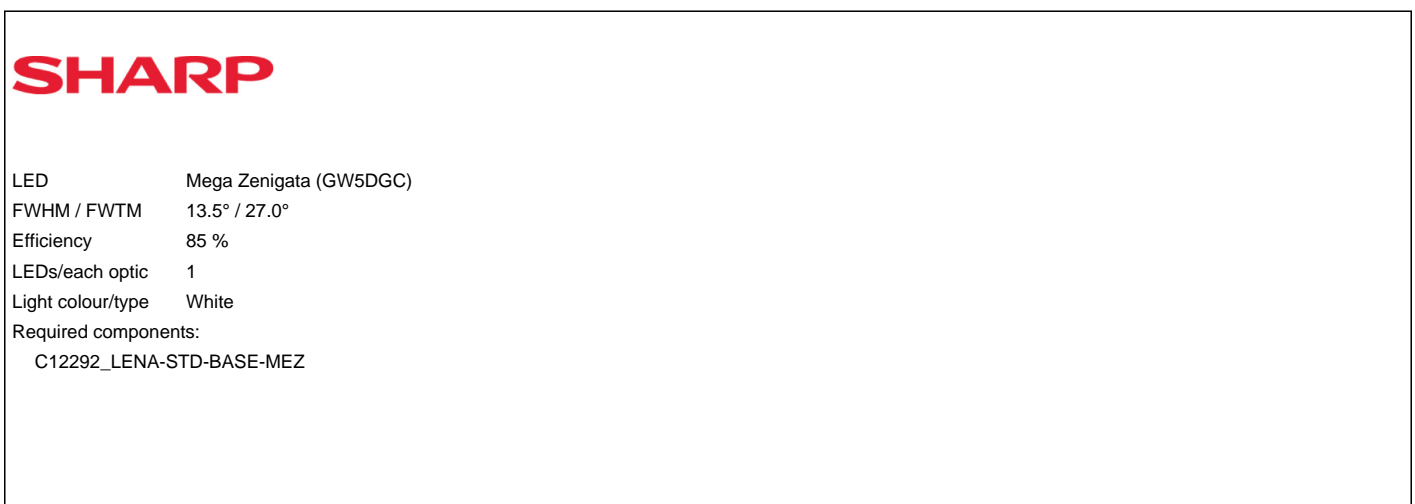
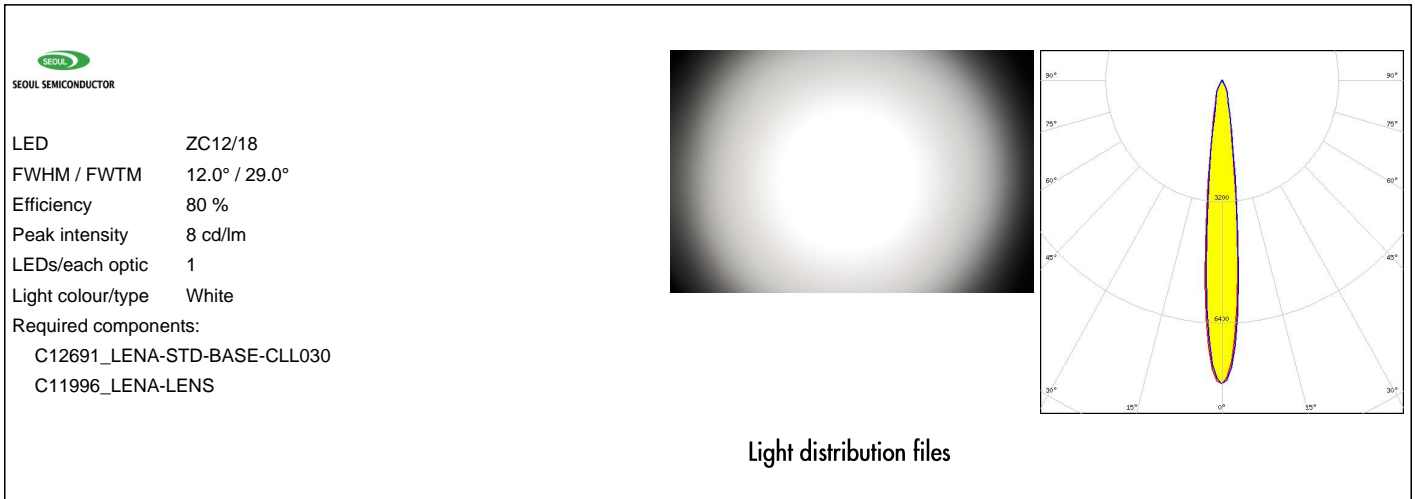

OPTICAL RESULTS (MEASURED):

SHARP

LED Mega Zenigata (GW6DME)
 FWHM / FWTM 12.0° / 24.0°
 Efficiency 83 %
 Peak intensity 10.2 cd/lm
 LEDs/each optic 1
 Light colour/type White
 Required components:
 C12292_LENA-STD-BASE-MEZ

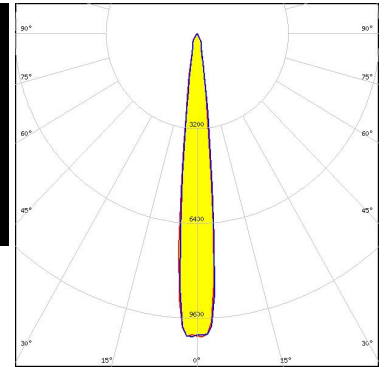
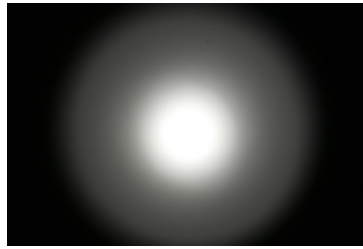

Light distribution files

SHARP

LED Mega Zenigata (GW6DME)
 FWHM / FWTM 14.0° / 34.0°
 Efficiency 77 %
 Peak intensity 6.2 cd/lm
 LEDs/each optic 1
 Light colour/type White
 Required components:
 C12292_LENA-STD-BASE-MEZ
 C11996_LENA-LENS

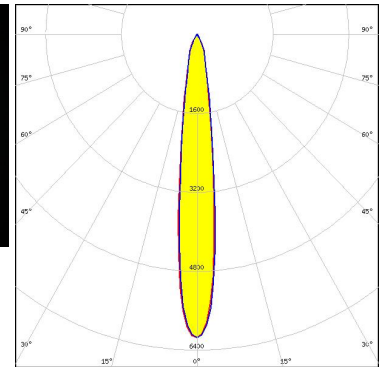

Light distribution files

TRIDONIC

LED SLE G7 LES15
 FWHM / FWTM 11.0° / 23.0°
 Efficiency 88 %
 Peak intensity 12.6 cd/lm
 LEDs/each optic 1
 Light colour/type White
 Required components:
 C12691_LENA-STD-BASE-CLL030

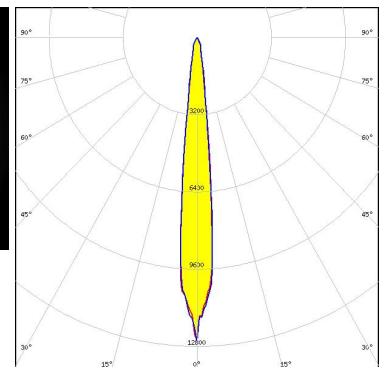

Light distribution files

OPTICAL RESULTS (MEASURED):

TRIDONIC

LED SLE G7 LES17 H
 FWHM / FWTM 14.0° / 29.0°
 Efficiency 86 %
 Peak intensity 9 cd/m
 LEDs/each optic 1
 Light colour/type White
 Required components:
 C14547_LENA-ADAPTER-B

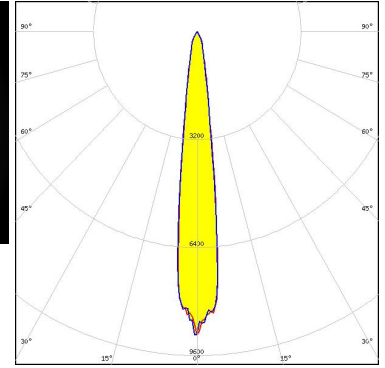

Light distribution files

TRIDONIC

LED SLE G7 LES21 H
 FWHM / FWTM 23.0° / 64.0°
 Efficiency 73 %
 Peak intensity 1.9 cd/m
 LEDs/each optic 1
 Light colour/type White
 Required components:
 C12231_LENA-FRESNEL

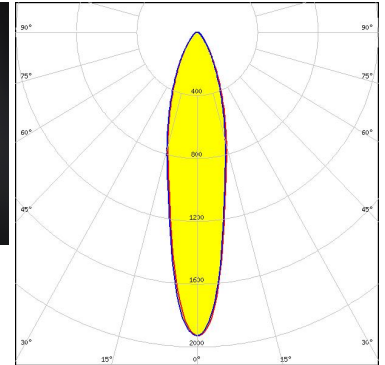

Light distribution files

TRIDONIC

LED SLE G7 LES21 H
 FWHM / FWTM 18.0° / 42.0°
 Efficiency 86 %
 Peak intensity 5.7 cd/m
 LEDs/each optic 1
 Light colour/type White
 Required components:
 C14547_LENA-ADAPTER-B

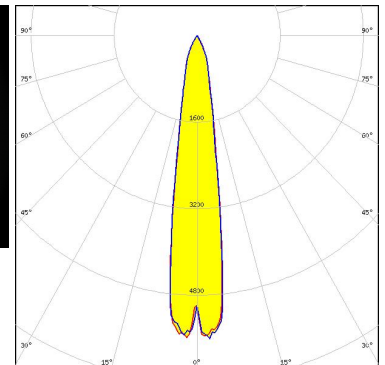
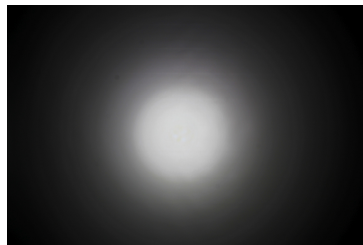

Light distribution files

OPTICAL RESULTS (MEASURED):

TRIDONIC

LED SLE G7 LES21 H
FWHM / FWTM 23.0° / 64.0°
Efficiency 73 %
Peak intensity 1.9 cd/lm
LEDs/each optic 1
Light colour/type White
Required components:
C14547_LENA-ADAPTER-B

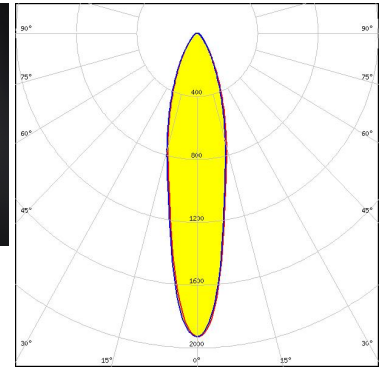
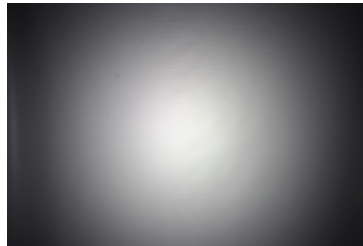

Light distribution files

XICATO

LED XOB 14.5 mm
FWHM / FWTM 12.0° / 23.0°
Efficiency 89 %
Peak intensity 12.5 cd/lm
LEDs/each optic 1
Light colour/type White
Required components:
C12691_LENA-STD-BASE-CLL030

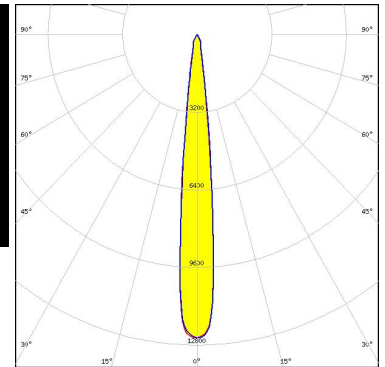

Light distribution files

OPTICAL RESULTS (SIMULATED):



LED V10 Gen7
 FWHM / FWTM 9.0° / 17.0°
 Efficiency 90 %
 Peak intensity 22.3 cd/lm
 LEDs/each optic 1
 Light colour/type White

Required components:

C13868_LENA-STD-BASE-VERO13-18

Bender Wirth: 486 Typ L1

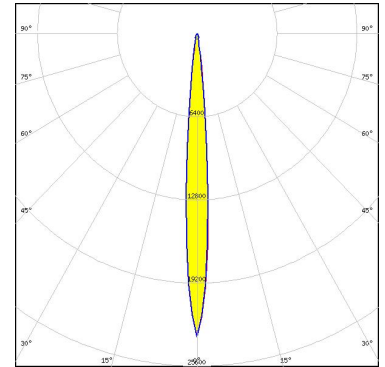

Light distribution files



LED V10 Gen7
 FWHM / FWTM 11.0° / 23.0°
 Efficiency 79 %
 Peak intensity 12.3 cd/lm
 LEDs/each optic 1
 Light colour/type White

Required components:

C13868_LENA-STD-BASE-VERO13-18

C11996_LENA-LENS

Bender Wirth: 486 Typ L1

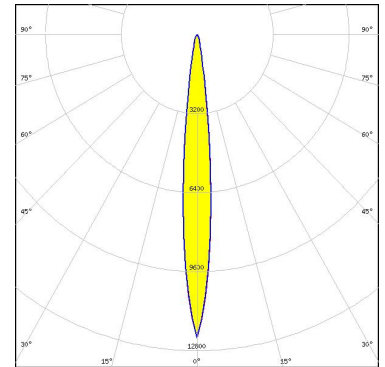

Light distribution files



LED V13 Gen7
 FWHM / FWTM 13.0° / 28.0°
 Efficiency 81 %
 Peak intensity 9 cd/lm
 LEDs/each optic 1
 Light colour/type White

Required components:

C13868_LENA-STD-BASE-VERO13-18

C11996_LENA-LENS

Bender Wirth: 477 Typ L1

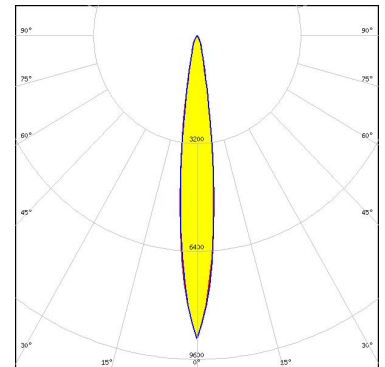

Light distribution files

OPTICAL RESULTS (SIMULATED):



LED V13 Gen7
 FWHM / FWTM 11.0° / 28.0°
 Efficiency 85 %
 Peak intensity 9.9 cd/lm
 LEDs/each optic 1
 Light colour/type White

Required components:
 C11996_LENA-LENS

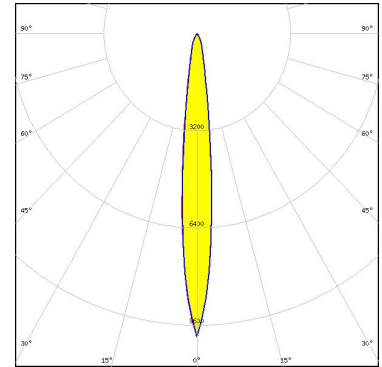

IDEAL: 50-2103CT + 50-2100LN

Light distribution files



LED V13 Gen7
 FWHM / FWTM 10.0° / 24.0°
 Efficiency 88 %
 Peak intensity 12.9 cd/lm
 LEDs/each optic 1
 Light colour/type White

Required components:

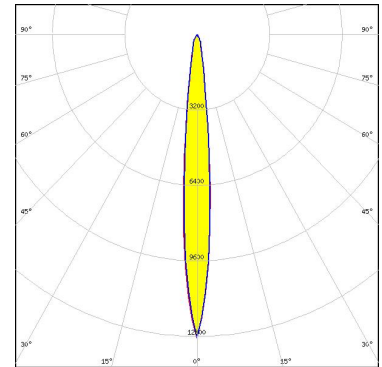

IDEAL: 50-2103CT + 50-2100LN

Light distribution files



LED V13 Gen7
 FWHM / FWTM 12.0° / 24.0°
 Efficiency 89 %
 Peak intensity 12.3 cd/lm
 LEDs/each optic 1
 Light colour/type White

Required components:
 C13868_LENA-STD-BASE-VERO13-18

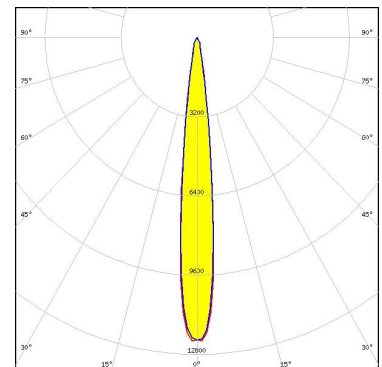

Bender Wirth: 477 Typ L1

Light distribution files

OPTICAL RESULTS (SIMULATED):



LED V22 Gen7
FWHM / FWTM 18.0° / 41.0°
Efficiency 90 %
Peak intensity 5.6 cd/lm
LEDs/each optic 1
Light colour/type White

Required components:
C13867_LENA-STD-BASE-VERO29

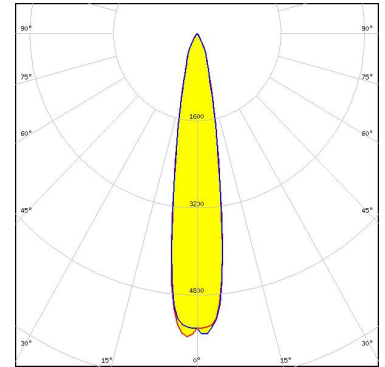

Bender Wirth: 431 Typ L3

Light distribution files



LED CXA/B 30xx
FWHM / FWTM 14.0° / 35.0°
Efficiency 87 %
Peak intensity 7.5 cd/lm
LEDs/each optic 1
Light colour/type White

Required components:

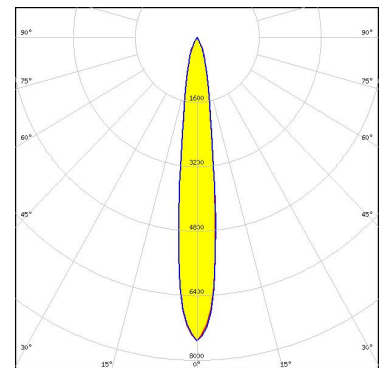

IDEAL: 50-2234C + 50-2100LN

Light distribution files



LED CXA/B 30xx
FWHM / FWTM 16.0° / 40.0°
Efficiency 80 %
Peak intensity 5.7 cd/lm
LEDs/each optic 1
Light colour/type White

Required components:

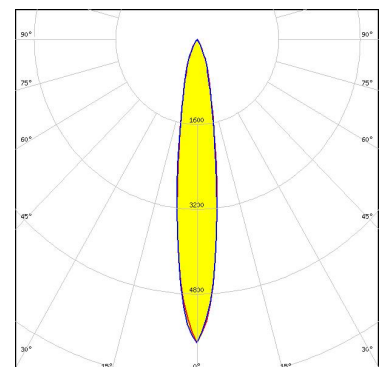

IDEAL: 50-2234C + 50-2100LN

Light distribution files

OPTICAL RESULTS (SIMULATED):



LED CxM-14 (19x19)
FWHM / FWTM 12.0° / 23.0°
Efficiency 85 %
Peak intensity 11.2 cd/lm
LEDs/each optic 1
Light colour/type White

Required components:

C13868_LENA-STD-BASE-VERO13-18

Bender Wirth: 433 Typ L1



LED CxM-14 (19x19)
FWHM / FWTM 14.0° / 32.0°
Efficiency 80 %
Peak intensity 6.7 cd/lm
LEDs/each optic 1
Light colour/type White

Required components:

C13868_LENA-STD-BASE-VERO13-18

C11996_LENA-LENS

Bender Wirth: 433 Typ L1



LED CxM-9 (13.5x13.5)
FWHM / FWTM 8.0° / 14.0°
Efficiency 85 %
Peak intensity 26.5 cd/lm
LEDs/each optic 1
Light colour/type White

Required components:

C13868_LENA-STD-BASE-VERO13-18

Bender Wirth: 434 Typ L1

OPTICAL RESULTS (SIMULATED):



LED CxM-9 (13.5x13.5)
FWHM / FWTM 10.0° / 22.0°
Efficiency 80 %
Peak intensity 11.5 cd/lm
LEDs/each optic 1
Light colour/type White

Required components:

C13868_LENA-STD-BASE-VERO13-18
C11996_LENA-LENS

Bender Wirth: 434 Typ L1



Opto Semiconductors

LED Soleriq S15
FWHM / FWTM 13.0° / 26.0°
Efficiency 88 %
Peak intensity 10.2 cd/lm
LEDs/each optic 1
Light colour/type White

Required components:

C12691_LENA-STD-BASE-CLL030

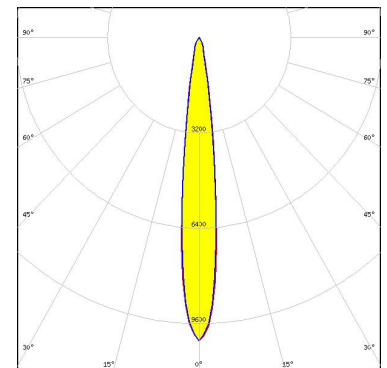

Light distribution files



SEOUL SEMICONDUCTOR

LED ZC12/18
FWHM / FWTM 12.0° / 23.0°
Efficiency 85 %
Peak intensity 11.2 cd/lm
LEDs/each optic 1
Light colour/type White

Required components:

C13868_LENA-STD-BASE-VERO13-18

Bender Wirth: 433 Typ L1

OPTICAL RESULTS (SIMULATED):

 SEOL SEMICONDUCTOR	
LED	ZC12/18
FWHM / FWTM	14.0° / 32.0°
Efficiency	80 %
Peak intensity	6.7 cd/lm
LEDs/each optic	1
Light colour/type	White
Required components:	
C13868_LENA-STD-BASE-VERO13-18	
C11996_LENA-LENS	
Bender Wirth: 433 Typ L1	

 SEOL SEMICONDUCTOR	
LED	ZC4/6
FWHM / FWTM	8.0° / 14.0°
Efficiency	85 %
Peak intensity	26.5 cd/lm
LEDs/each optic	1
Light colour/type	White
Required components:	
C13868_LENA-STD-BASE-VERO13-18	
Bender Wirth: 434 Typ L1	

 SEOL SEMICONDUCTOR	
LED	ZC4/6
FWHM / FWTM	10.0° / 22.0°
Efficiency	80 %
Peak intensity	11.5 cd/lm
LEDs/each optic	1
Light colour/type	White
Required components:	
C13868_LENA-STD-BASE-VERO13-18	
C11996_LENA-LENS	
Bender Wirth: 434 Typ L1	

GENERAL INFORMATION:

NOTE: The typical beam angle will be changed by different color, chip size and chip position tolerance. The typical total beam angle is the full angle measured where the luminous intensity is half of the peak value.

Due to use of high power COB's with this product, special attention to proper thermal design is highly recommended. LEDiL has no liability for direct, indirect or consecutive damages arising from the LEDiL products being used outside of the recommended temperature range.

MATERIALS:

As part of our continuous research and improvement processes, and to ensure the best possible quality and availability of our products, LEDiL reserves the right to change material grades without notice.

PRODUCT DATA USER AGREEMENT AND DISCLAIMER:

The measured data in the provided downloadable LEDiL Product Datasheets and Mechanical 2D-Drawings is rounded and provided as reference for planning. LEDiL Oy's optical specifications have been verified by conducting performance testing of the products in accordance with the company's quality system. The reported data are averaged results of multiple measurements with typical variation. LEDiL Oy reserves the right to without prior notification make changes and improvements to its products.

LEDiL Oy assumes neither warranty, nor guarantee nor any other liability of any kind for the contents and correctness of the provided data. The provided data has been generated with highest diligence but the provided data may in reality not represent the complete possible variation range of all intrinsic parameters. Therefore, in certain cases a deviation from the provided data could occur.

LEDiL Oy reserves the right to undertake technical changes of its products without further notification which could lead to changes in the provided data. LEDiL Oy assumes no liability of any kind for the possible deviation from any provided data or any other damage resulting from the usage of the provided data.

The user agrees to this disclaimer and user agreement with the download or usage of the provided files.

LEDiL Oy

Joensuunkatu 7
FI-24240 SALO
Finland

LEDiL Inc.

228 West Page Street
Suite D
Sycamore IL 60178
USA

Ledil Optics Technology (Shenzhen) Co., Ltd.

405 , Block B
Casic Motor Building
Shenzhen 518057
P.R.CHINA

Local sales and technical support

[www.ledil.com/
where_to_buy](http://www.ledil.com/where_to_buy)

Shipping locations

Poznan, Poland
Hong Kong, China

Distribution Partners

[www.ledil.com/
where_to_buy](http://www.ledil.com/where_to_buy)