

## LENINA-M

~30° medium beam

### SPECIFICATION:

Dimensions	Ø 74.0
Height	40 mm
Fastening	socket
ROHS compliant	yes ⓘ

### MATERIALS:

Component	Type	Material	Colour	Finish	Coating
LENINA-M	Reflector	PC	metal		lacquer



### ORDERING INFORMATION:

Component	Qty in box	MOQ	MPQ	Box weight (kg)
C12598_LENINA-M » Box size: 476 x 273 x 197 mm	60	120	60	2.0

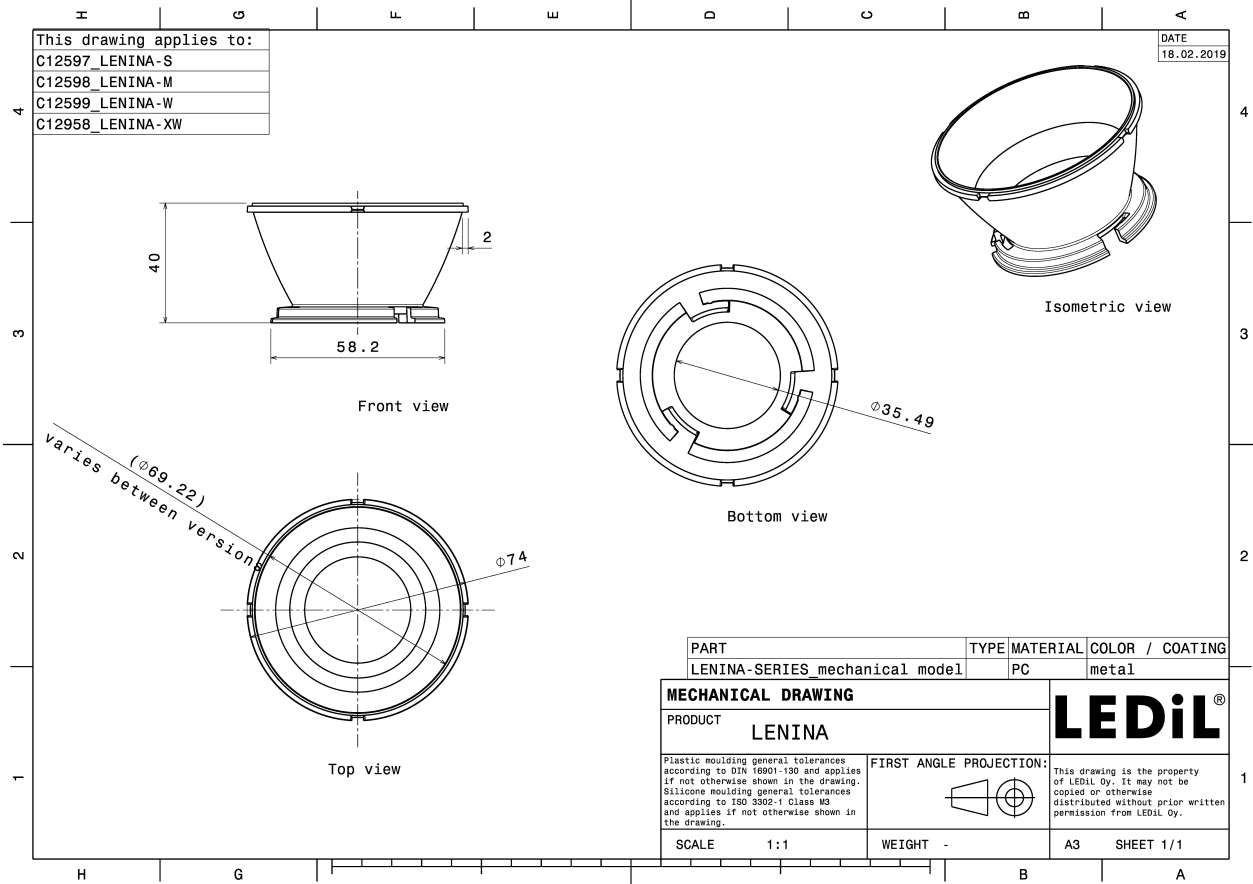

See also our general installation guide: [www.ledil.com/installation\\_guide](http://www.ledil.com/installation_guide)

#### OPTICAL RESULTS (MEASURED):



**LED** BXRA ES Rectangle  
**FWHM / FWTM** 29.0° / 75.0°  
**Efficiency** 86 %  
**LEDs/each optic** 1  
**Light colour/type** White  
**Required components:**  
 C12153\_LENINA-STD-BASE-BXRA

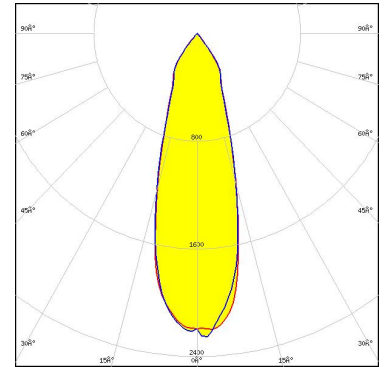

Light distribution files



**LED** BXRA ES Rectangle  
**FWHM / FWTM** 36.0° / 76.0°  
**Efficiency** 78 %  
**LEDs/each optic** 1  
**Light colour/type** White  
**Required components:**  
 C12153\_LENINA-STD-BASE-BXRA  
 C12606\_LENINA-DL

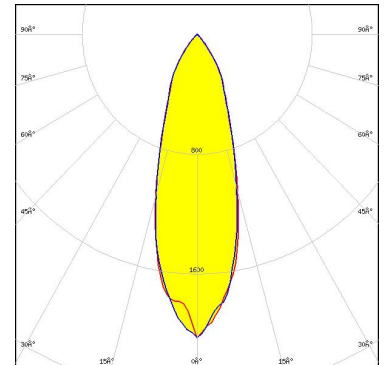

Light distribution files



**LED** BXRA RS  
**FWHM / FWTM** 44.0° / 82.0°  
**Efficiency** 88 %  
**Peak intensity** 1.4 cd/lm  
**LEDs/each optic** 1  
**Light colour/type** White  
**Required components:**  
 C12229\_LENINA-STD-BASE-RS

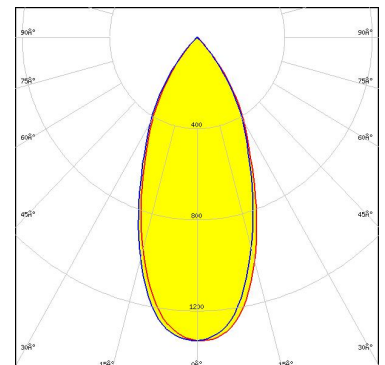

Light distribution files

### OPTICAL RESULTS (MEASURED):



**LED** BXRA RS  
**FWHM / FWTM** 47.0° / 89.0°  
**Efficiency** 80 %  
**Peak intensity** 1.2 cd/lm  
**LEDs/each optic** 1  
**Light colour/type** White  
**Required components:**  
 C12229\_LENINA-STD-BASE-RS  
 C12606\_LENINA-DL

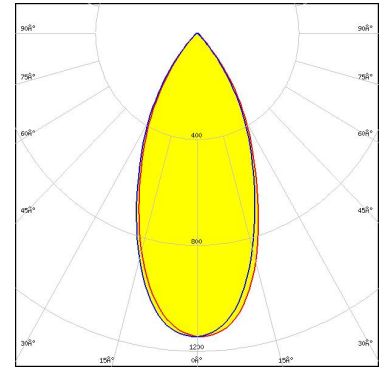

Light distribution files



**LED** V10 Gen6  
**FWHM / FWTM** 21.0° / 68.0°  
**Efficiency** 84 %  
**Peak intensity** 3.2 cd/lm  
**LEDs/each optic** 1  
**Light colour/type** White  
**Required components:**  
 C13186\_LENINA-STD-BASE-CXA15  
 C12606\_LENINA-DL

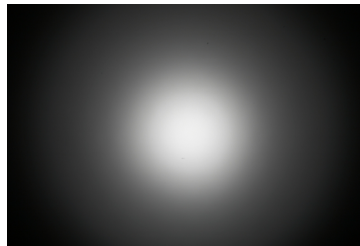

Light distribution files



**LED** Vero SE 29  
**FWHM / FWTM** 51.0° / 84.0°  
**Efficiency** 92 %  
**Peak intensity** 1.2 cd/lm  
**LEDs/each optic** 1  
**Light colour/type** White  
**Required components:**  
 C15083\_LENINA-STD-BASE-VERO29

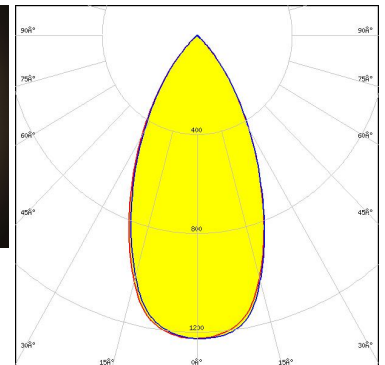
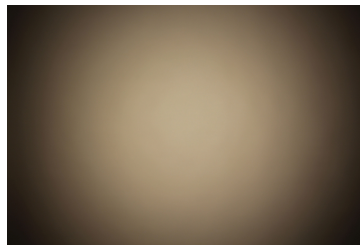

Light distribution files

### OPTICAL RESULTS (MEASURED):



LED VERO13  
FWHM / FWTM 31.0° / 74.0°  
Efficiency 87 %  
Peak intensity 2 cd/lm  
LEDs/each optic 1  
Light colour/type White  
Required components:  
C13868\_LENINA-STD-BASE-VERO13-18  
C12606\_LENINA-DL

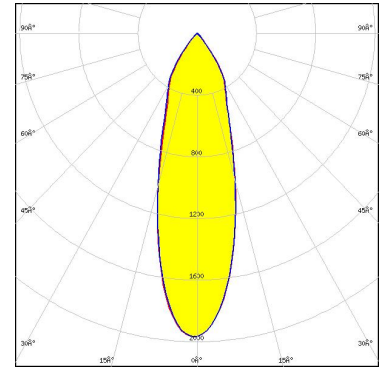

Light distribution files



LED VERO13  
FWHM / FWTM 28.0° / 74.0°  
Efficiency 91 %  
Peak intensity 2.4 cd/lm  
LEDs/each optic 1  
Light colour/type White  
Required components:  
C13868\_LENINA-STD-BASE-VERO13-18

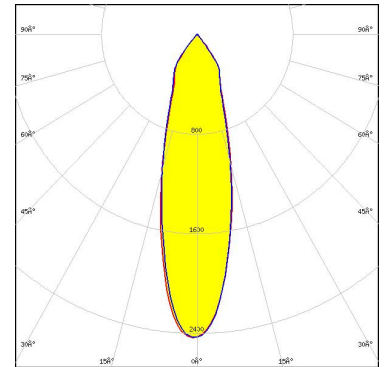

Light distribution files



LED VERO18  
FWHM / FWTM 37.0° / 77.0°  
Efficiency 86 %  
Peak intensity 1.6 cd/lm  
LEDs/each optic 1  
Light colour/type White  
Required components:  
C13868\_LENINA-STD-BASE-VERO13-18  
C12606\_LENINA-DL

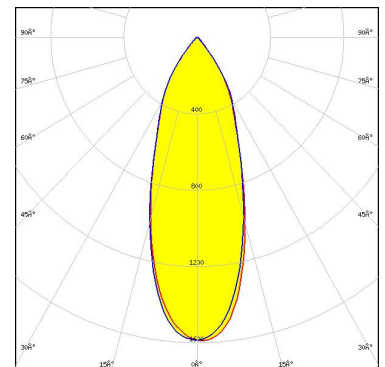

Light distribution files

### OPTICAL RESULTS (MEASURED):



**LED** VERO18  
**FWHM / FWTM** 35.0° / 76.0°  
**Efficiency** 90 %  
**Peak intensity** 1.9 cd/lm  
**LEDs/each optic** 1  
**Light colour/type** White  
**Required components:**  
 C13868\_LENINA-STD-BASE-VERO13-18

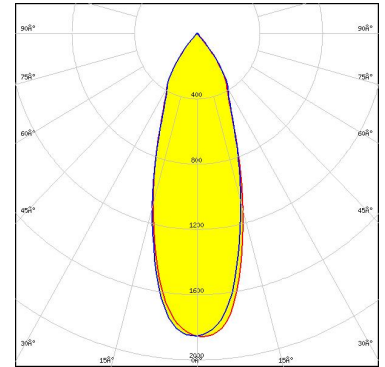

Light distribution files



**LED** VERO29  
**FWHM / FWTM** 52.0° / 85.0°  
**Efficiency** 85 %  
**Peak intensity** 1.1 cd/lm  
**LEDs/each optic** 1  
**Light colour/type** White  
**Required components:**  
 C13867\_LENINA-STD-BASE-VERO29  
 C12606\_LENINA-DL

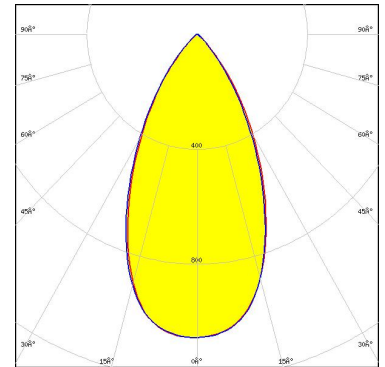

Light distribution files



**LED** VERO29  
**FWHM / FWTM** 52.0° / 84.0°  
**Efficiency** 89 %  
**Peak intensity** 1.2 cd/lm  
**LEDs/each optic** 1  
**Light colour/type** White  
**Required components:**  
 C13867\_LENINA-STD-BASE-VERO29

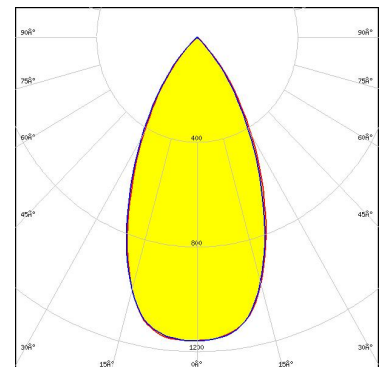

Light distribution files

### OPTICAL RESULTS (MEASURED):

#### CITIZEN

LED CL-L340  
FWHM / FWTM 30.0° / 74.0°  
Efficiency 86 %  
LEDs/each optic 1  
Light colour/type White  
Required components:  
C11995\_LENINA-STD-BASE-CL340

[Light distribution files](#)

#### CITIZEN

LED CL-L340  
FWHM / FWTM 26.0° / 71.0°  
Efficiency 92 %  
Peak intensity 2.5 cd/m  
LEDs/each optic 1  
Light colour/type White  
Required components:  
C11995\_LENINA-STD-BASE-CL340

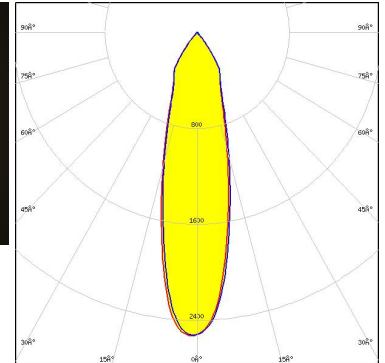
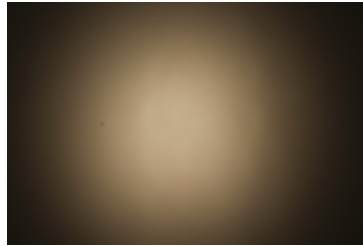

[Light distribution files](#)

#### CITIZEN

LED CL-L340  
FWHM / FWTM 35.0° / 76.0°  
Efficiency 78 %  
LEDs/each optic 1  
Light colour/type White  
Required components:  
C11995\_LENINA-STD-BASE-CL340  
C12606\_LENINA-DL

[Light distribution files](#)

#### OPTICAL RESULTS (MEASURED):

### CITIZEN

LED CLL02x/CLU02x (LES10)  
 FWHM / FWTM 26.0° / 71.0°  
 Efficiency 87 %  
 Peak intensity 2.3 cd/lm  
 LEDs/each optic 1  
 Light colour/type White  
 Required components:  
 C13868\_LENINA-STD-BASE-VERO13-18  
 C12606\_LENINA-DL  
 Bender Wirth: 434 Typ L1

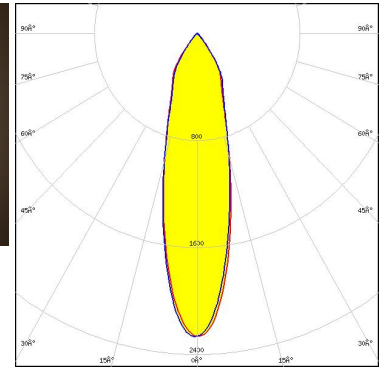
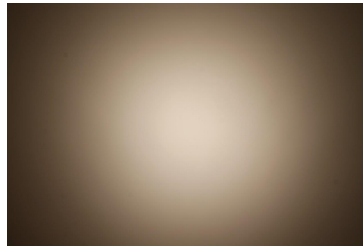

Light distribution files

### CITIZEN

LED CLL02x/CLU02x (LES10)  
 FWHM / FWTM 23.0° / 71.0°  
 Efficiency 91 %  
 Peak intensity 3 cd/lm  
 LEDs/each optic 1  
 Light colour/type White  
 Required components:  
 C13868\_LENINA-STD-BASE-VERO13-18  
 Bender Wirth: 434 Typ L1

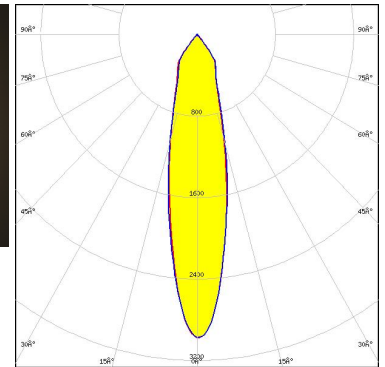
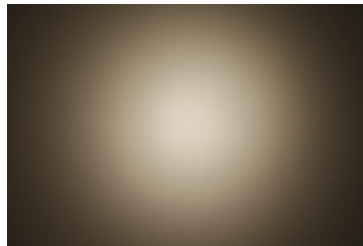

Light distribution files

### CITIZEN

LED CLL03x/CLU03x  
 FWHM / FWTM 30.0° / 73.0°  
 Efficiency 87 %  
 Peak intensity 2 cd/lm  
 LEDs/each optic 1  
 Light colour/type White  
 Required components:  
 C12691\_LENINA-STD-BASE-CLL030  
 C12606\_LENINA-DL

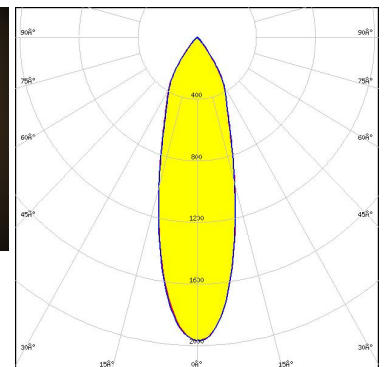
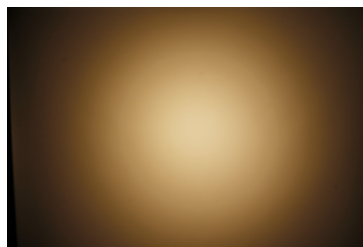

Light distribution files



### OPTICAL RESULTS (MEASURED):

#### CITIZEN

LED CLL03x/CLU03x  
 FWHM / FWTM 29.0° / 73.0°  
 Efficiency 91 %  
 Peak intensity 2.3 cd/lm  
 LEDs/each optic 1  
 Light colour/type White  
 Required components:  
 C13868\_LENINA-STD-BASE-VERO13-18  
 Bender Wirth: 433 Typ L1

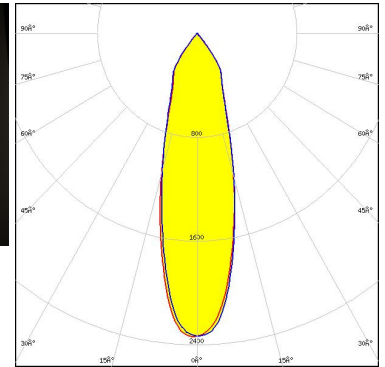
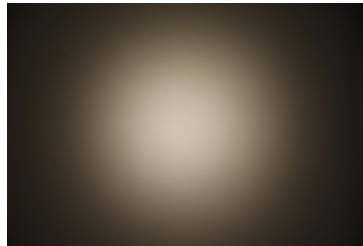

Light distribution files

#### CITIZEN

LED CLL03x/CLU03x  
 FWHM / FWTM 28.0° / 73.0°  
 Efficiency 91 %  
 Peak intensity 2.4 cd/lm  
 LEDs/each optic 1  
 Light colour/type White  
 Required components:  
 C12691\_LENINA-STD-BASE-CLL030

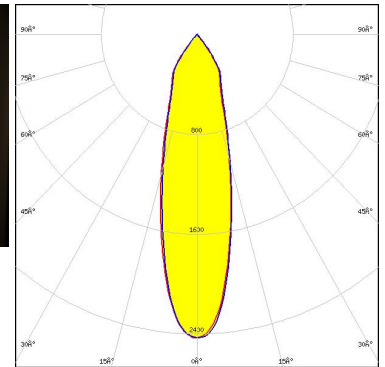
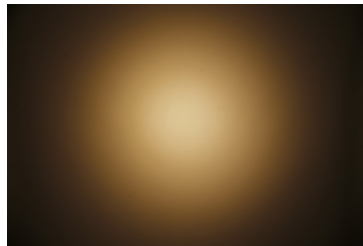

Light distribution files

#### CITIZEN

LED CLL03x/CLU03x  
 FWHM / FWTM 31.0° / 73.0°  
 Efficiency 88 %  
 Peak intensity 2 cd/lm  
 LEDs/each optic 1  
 Light colour/type White  
 Required components:  
 C13868\_LENINA-STD-BASE-VERO13-18  
 C12606\_LENINA-DL  
 Bender Wirth: 433 Typ L1

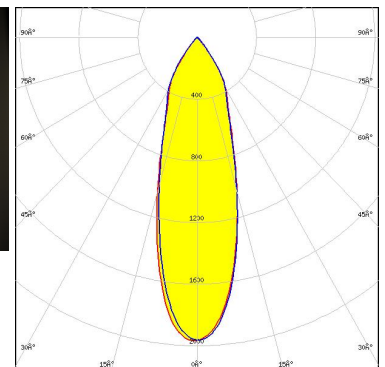
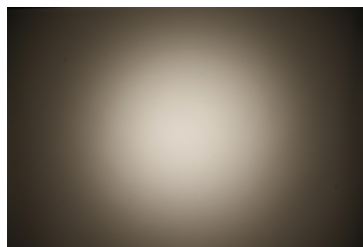

Light distribution files

### OPTICAL RESULTS (MEASURED):

#### CITIZEN

LED CLL04x/CLU04x  
FWHM / FWTM 36.0° / 76.0°  
Efficiency 83 %  
Peak intensity 1.6 cd/lm  
LEDs/each optic 1  
Light colour/type White  
Required components:  
A.A.G. STUCCHI: 8102-G2 + S-8000-12

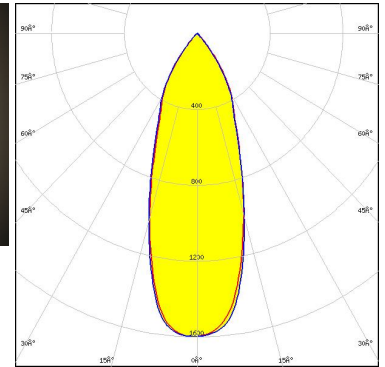
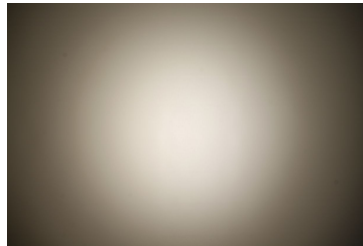

Light distribution files

#### CITIZEN

LED CLL04x/CLU04x  
FWHM / FWTM 40.0° / 77.0°  
Efficiency 86 %  
Peak intensity 1.5 cd/lm  
LEDs/each optic 1  
Light colour/type White  
Required components:  
C12692\_LENASTD-BASE-CLL040

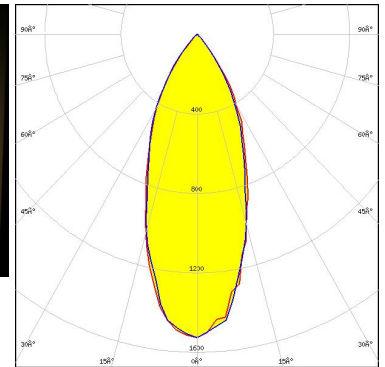
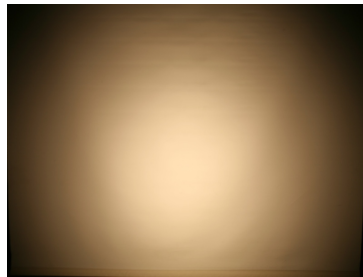

Light distribution files

#### CITIZEN

LED CLL04x/CLU04x  
FWHM / FWTM 39.0° / 78.0°  
Efficiency 92 %  
Peak intensity 1.7 cd/lm  
LEDs/each optic 1  
Light colour/type White  
Required components:  
C13867\_LENASTD-BASE-VERO29  
Bender Wirth: 431 Typ L3

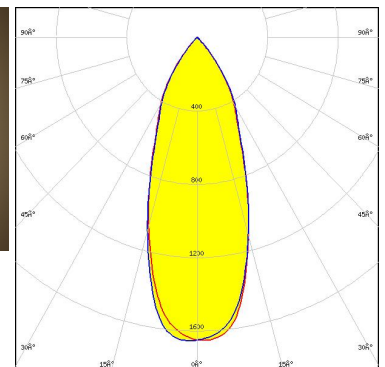
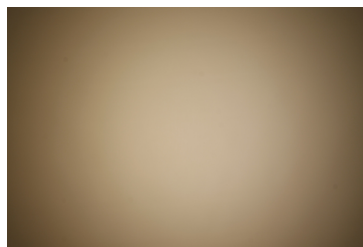

Light distribution files

### OPTICAL RESULTS (MEASURED):

#### CITIZEN

LED CLL04x/CLU04x  
 FWHM / FWTM 38.0° / 77.0°  
 Efficiency 76 %  
 Peak intensity 1.4 cd/lm  
 LEDs/each optic 1  
 Light colour/type White  
 Required components:  
 C12606\_LENINA-DL  
 A.A.G. STUCCHI: 8102-G2 + S-8000-12

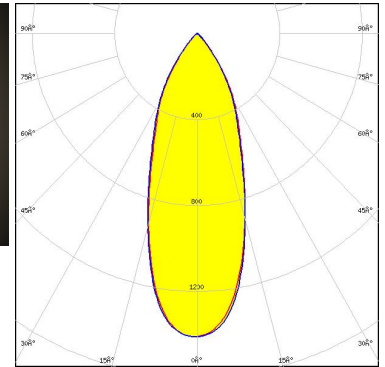
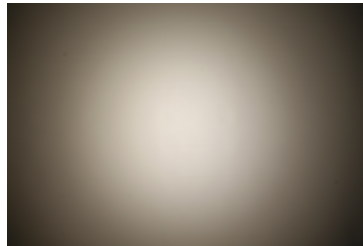

Light distribution files

#### CITIZEN

LED CLL04x/CLU04x  
 FWHM / FWTM 43.0° / 80.0°  
 Efficiency 78 %  
 Peak intensity 1.2 cd/lm  
 LEDs/each optic 1  
 Light colour/type White  
 Required components:  
 C12692\_LENINA-STD-BASE-CLL040  
 C12606\_LENINA-DL

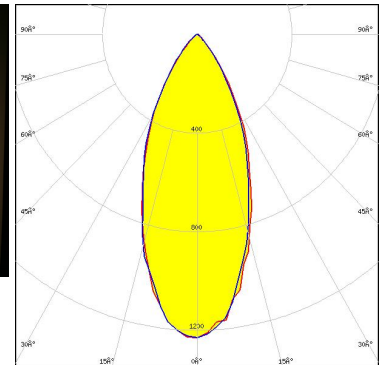
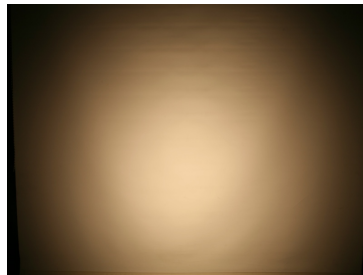

Light distribution files

#### CITIZEN

LED CLL04x/CLU04x  
 FWHM / FWTM 35.0° / 75.0°  
 Efficiency 90 %  
 Peak intensity 1.8 cd/lm  
 LEDs/each optic 1  
 Light colour/type White  
 Required components:  
 IDEAL: 50-2204CT + 50-2100LN

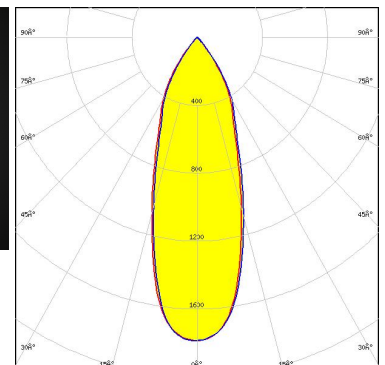
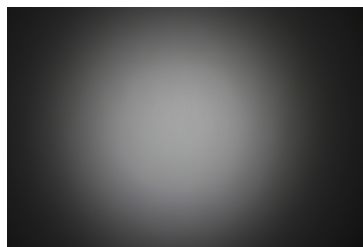

Light distribution files

### OPTICAL RESULTS (MEASURED):

#### CITIZEN

LED CLL04x/CLU04x  
 FWHM / FWTM 40.0° / 78.0°  
 Efficiency 87 %  
 Peak intensity 1.4 cd/lm  
 LEDs/each optic 1  
 Light colour/type White

Required components:

C13867\_LENINA-STD-BASE-VERO29

C12606\_LENINA-DL

Bender Wirth: 431 Typ L3

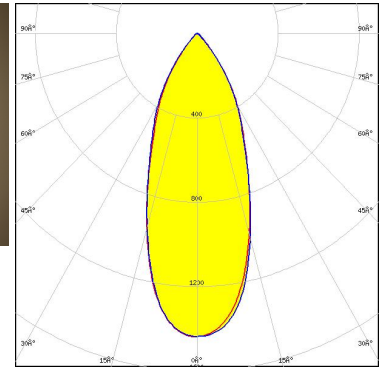
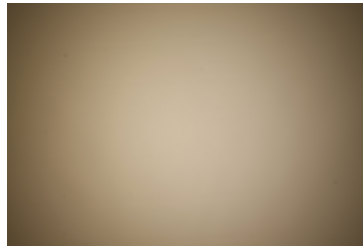

Light distribution files

#### CITIZEN

LED CLL04x/CLU04x  
 FWHM / FWTM 37.0° / 76.0°  
 Efficiency 87 %  
 Peak intensity 1.6 cd/lm  
 LEDs/each optic 1  
 Light colour/type White

Required components:

C12606\_LENINA-DL

IDEAL: 50-2204CT + 50-2100LN

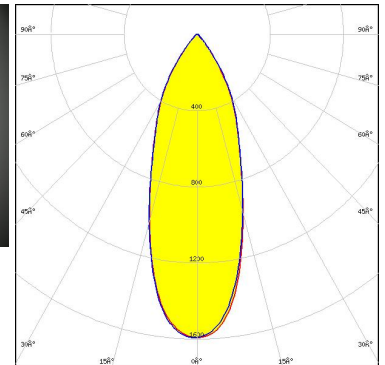
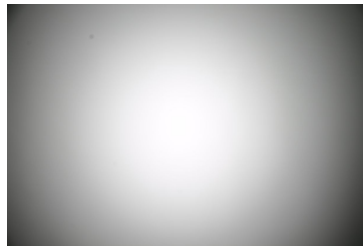

Light distribution files

#### CITIZEN

LED CLU700/701/702/703  
 FWHM / FWTM 23.0° / 70.0°  
 Efficiency 87 %  
 Peak intensity 2.7 cd/lm  
 LEDs/each optic 1  
 Light colour/type White

Required components:

C13868\_LENINA-STD-BASE-VERO13-18

C12606\_LENINA-DL

Bender Wirth: 434 Typ L1

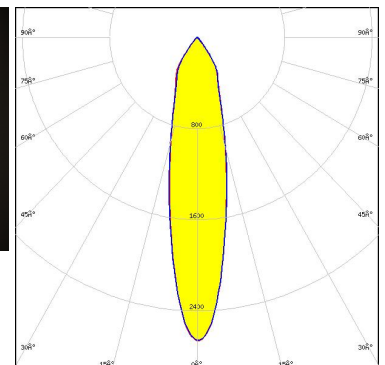
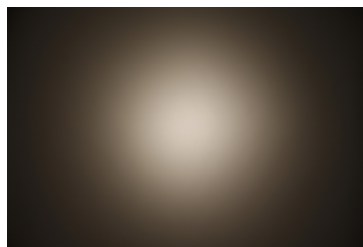

Light distribution files

#### OPTICAL RESULTS (MEASURED):

### CITIZEN

LED CLU700/701/702/703  
 FWHM / FWTM 17.0° / 60.0°  
 Efficiency 91 %  
 Peak intensity 3.8 cd/lm  
 LEDs/each optic 1  
 Light colour/type White  
 Required components:  
 C13868\_LENINA-STD-BASE-VERO13-18  
 Bender Wirth: 434 Typ L1

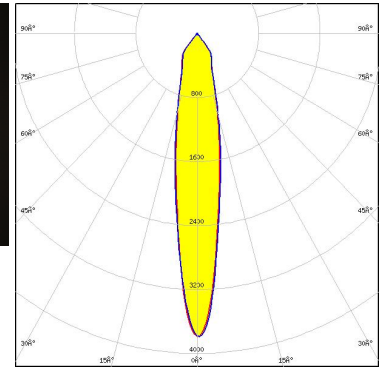

Light distribution files

### CITIZEN

LED CLU710/711  
 FWHM / FWTM 19.0° / 68.0°  
 Efficiency 93 %  
 Peak intensity 3.3 cd/lm  
 LEDs/each optic 1  
 Light colour/type White  
 Required components:  
 C12691\_LENINA-STD-BASE-CLL030

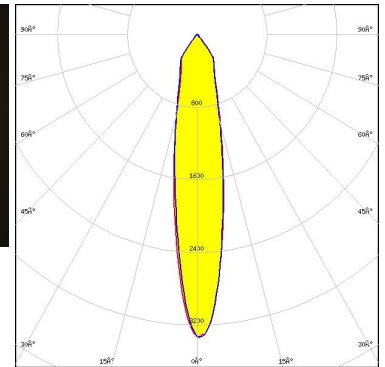
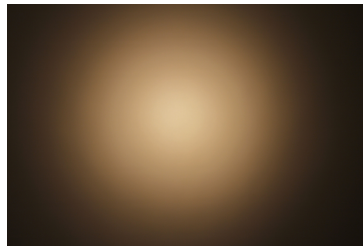

Light distribution files

### CITIZEN

LED CLU710/711  
 FWHM / FWTM 24.0° / 71.0°  
 Efficiency 89 %  
 Peak intensity 2.4 cd/lm  
 LEDs/each optic 1  
 Light colour/type White  
 Required components:  
 C12691\_LENINA-STD-BASE-CLL030  
 C12606\_LENINA-DL

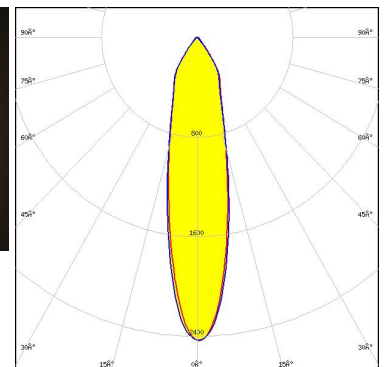
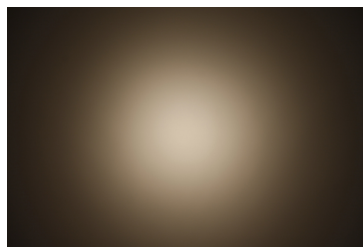

Light distribution files

### OPTICAL RESULTS (MEASURED):

#### CITIZEN

LED CLU720/721/723  
FWHM / FWTM 23.0° / 71.0°  
Efficiency 88 %  
Peak intensity 2.7 cd/lm  
LEDs/each optic 1  
Light colour/type White  
Required components:  
C12691\_LENINA-STD-BASE-CLL030

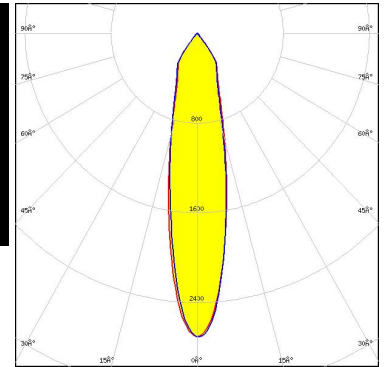
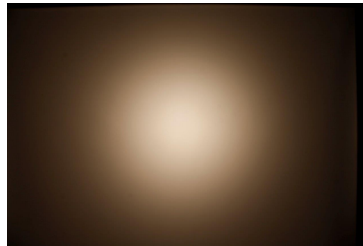

Light distribution files

#### CITIZEN

LED CLU720/721/723  
FWHM / FWTM 26.0° / 72.0°  
Efficiency 84 %  
Peak intensity 2.1 cd/lm  
LEDs/each optic 1  
Light colour/type White  
Required components:  
C12691\_LENINA-STD-BASE-CLL030  
C12606\_LENINA-DL

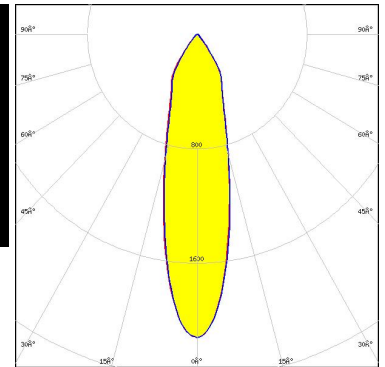
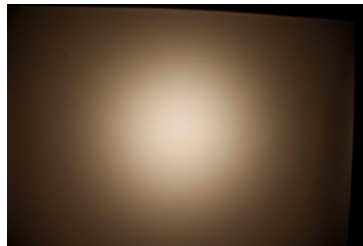

Light distribution files

#### CITIZEN

LED CLU730/731/733  
FWHM / FWTM 24.0° / 70.0°  
Efficiency 94 %  
Peak intensity 2.8 cd/lm  
LEDs/each optic 1  
Light colour/type White  
Required components:  
C12692\_LENINA-STD-BASE-CLL040

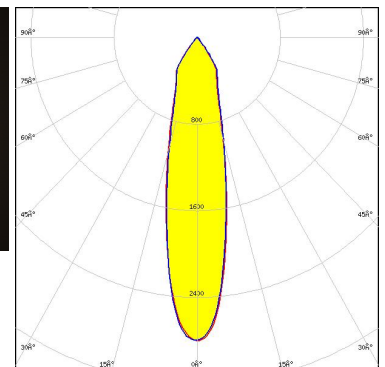
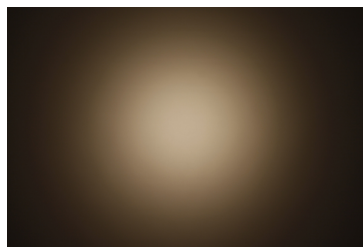

Light distribution files

#### OPTICAL RESULTS (MEASURED):

### CITIZEN

LED CLU730/731/733  
 FWHM / FWTM 26.0° / 71.0°  
 Efficiency 84 %  
 Peak intensity 2.1 cd/lm  
 LEDs/each optic 1  
 Light colour/type White  
 Required components:  
 C12692\_LENINA-STD-BASE-CLL040  
 C12606\_LENINA-DL

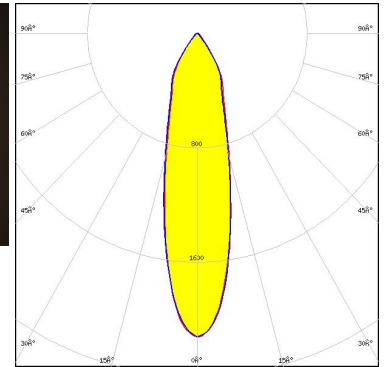
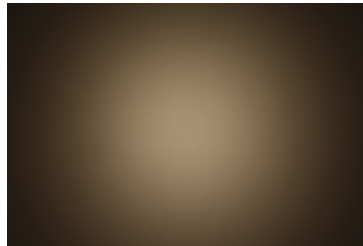

Light distribution files



LED CMA1840  
 FWHM / FWTM 25.0° / 70.0°  
 Efficiency 92 %  
 Peak intensity 2.7 cd/lm  
 LEDs/each optic 1  
 Light colour/type White  
 Required components:  
 C14146\_LENINA-STD-BASE-CXA18

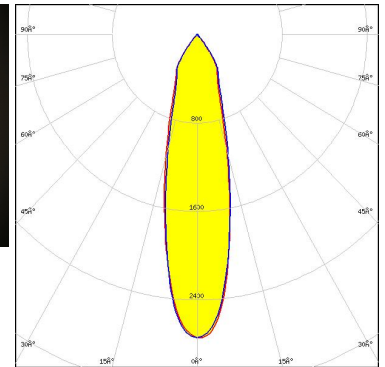
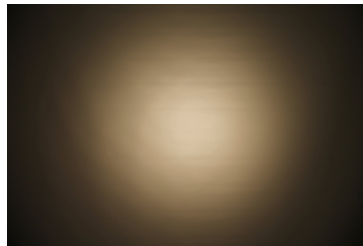

Light distribution files



LED CMA1840  
 FWHM / FWTM 25.0° / 70.0°  
 Efficiency 92 %  
 Peak intensity 2.7 cd/lm  
 LEDs/each optic 1  
 Light colour/type White  
 Required components:  
 C14146\_LENINA-STD-BASE-CXA18

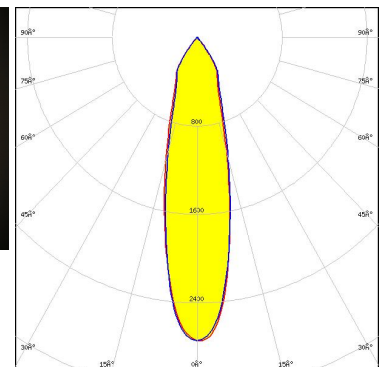
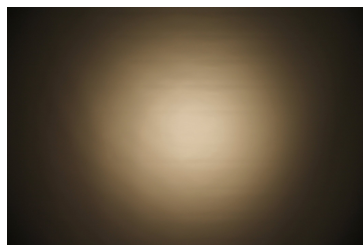

Light distribution files

### OPTICAL RESULTS (MEASURED):



LED CMA2550  
 FWHM / FWTM 32.0° / 73.0°  
 Efficiency 92 %  
 Peak intensity 2.1 cd/lm  
 LEDs/each optic 1  
 Light colour/type White  
 Required components:  
 C13324\_LENINA-STD-BASE-CXA25

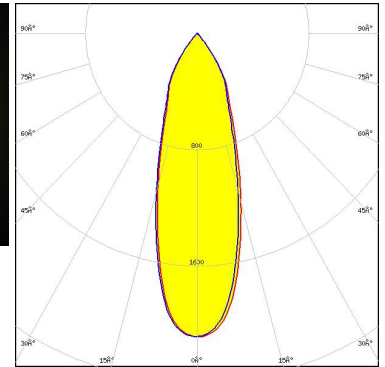
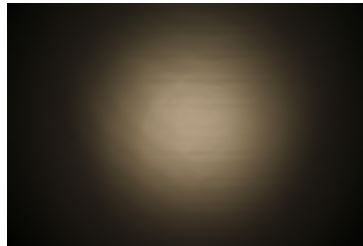

Light distribution files



LED CMT14xx  
 FWHM / FWTM 25.0° / 73.0°  
 Efficiency 92 %  
 Peak intensity 2.8 cd/lm  
 LEDs/each optic 1  
 Light colour/type White  
 Required components:  
 C13868\_LENINA-STD-BASE-VERO13-18  
 Bender Wirth: 434 Typ L1

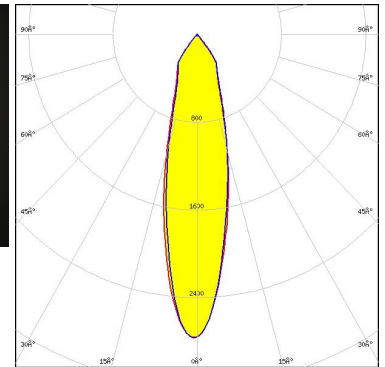
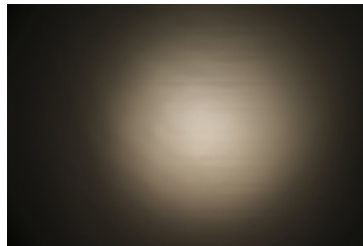

Light distribution files



LED CMT19xx  
 FWHM / FWTM 30.0° / 74.0°  
 Efficiency 92 %  
 Peak intensity 2.3 cd/lm  
 LEDs/each optic 1  
 Light colour/type White  
 Required components:  
 C13868\_LENINA-STD-BASE-VERO13-18  
 Bender Wirth: 477 Typ L1

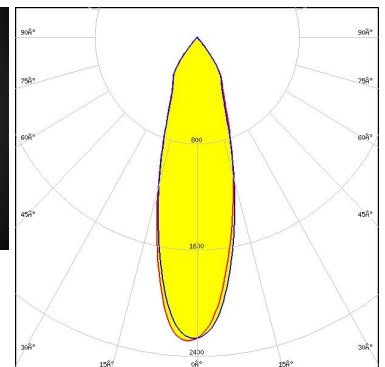
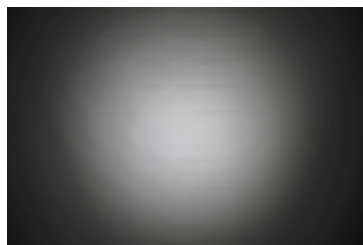

Light distribution files



### OPTICAL RESULTS (MEASURED):



LED CMT19xx  
 FWHM / FWTM 29.0° / 73.0°  
 Efficiency 92 %  
 Peak intensity 2.4 cd/lm  
 LEDs/each optic 1  
 Light colour/type White  
 Required components:  
 C12691\_LENINA-STD-BASE-CLL030

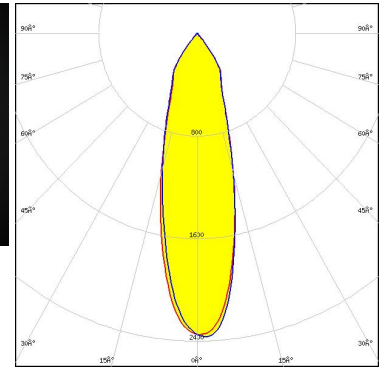
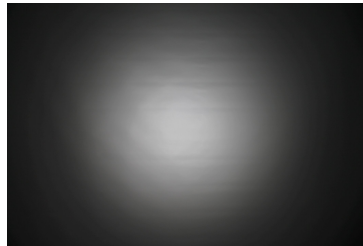

Light distribution files



LED CMT28xx  
 FWHM / FWTM 39.0° / 77.0°  
 Efficiency 92 %  
 Peak intensity 1.7 cd/lm  
 LEDs/each optic 1  
 Light colour/type White  
 Required components:  
 C13867\_LENINA-STD-BASE-VERO29  
 Bender Wirth: 471 Typ L3

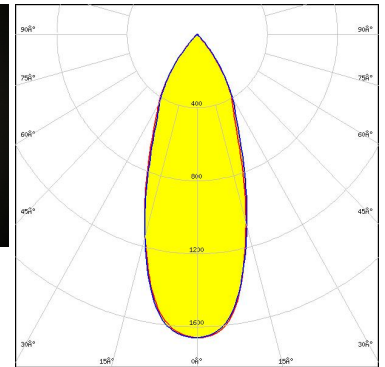
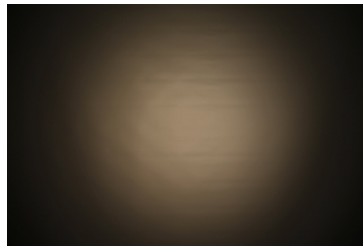

Light distribution files



LED CMT28xx  
 FWHM / FWTM 37.0° / 76.0°  
 Efficiency 92 %  
 Peak intensity 1.8 cd/lm  
 LEDs/each optic 1  
 Light colour/type White  
 Required components:  
 C12692\_LENINA-STD-BASE-CLL040

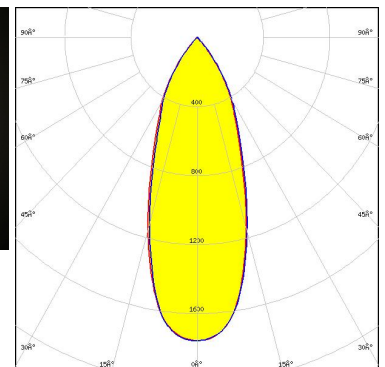
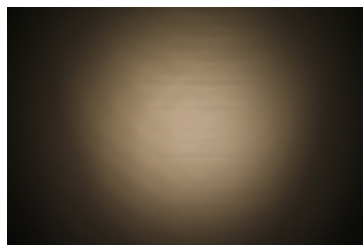

Light distribution files

### OPTICAL RESULTS (MEASURED):



LED CXA/B 15xx  
 FWHM / FWTM 26.0° / 71.0°  
 Efficiency 87 %  
 Peak intensity 2.3 cd/lm  
 LEDs/each optic 1  
 Light colour/type White

Required components:

C13868\_LENINA-STD-BASE-VERO13-18

C12606\_LENINA-DL

Bender Wirth: 441 Typ L1

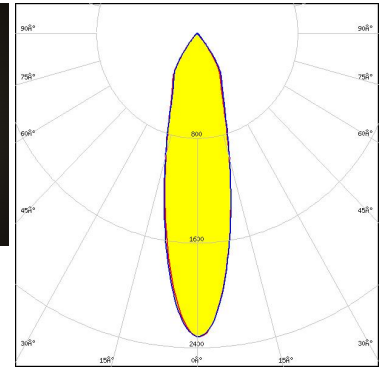
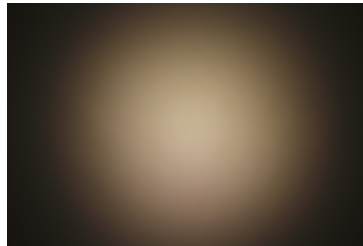

Light distribution files



LED CXA/B 15xx  
 FWHM / FWTM 17.0° / 56.0°  
 Efficiency 91 %  
 Peak intensity 4.1 cd/lm  
 LEDs/each optic 1  
 Light colour/type White

Required components:

C13186\_LENINA-STD-BASE-CXA15

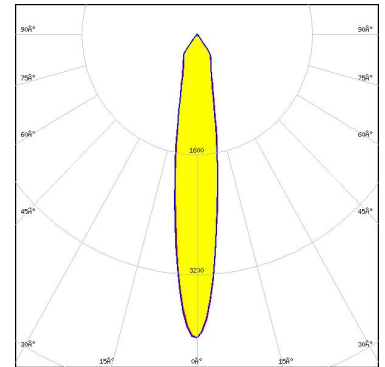

Light distribution files



LED CXA/B 15xx  
 FWHM / FWTM 22.0°  
 Efficiency %  
 Peak intensity 3.1 cd/lm  
 LEDs/each optic 1  
 Light colour/type White

Required components:

C13868\_LENINA-STD-BASE-VERO13-18

Bender Wirth: 441 Typ L1

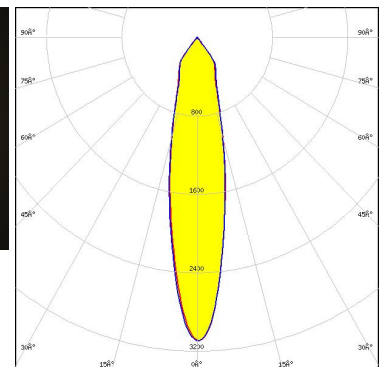
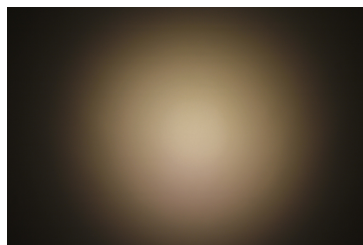

Light distribution files

### OPTICAL RESULTS (MEASURED):



LED CXA/B 15xx  
 FWHM / FWTM 22.0° / 66.0°  
 Efficiency 86 %  
 Peak intensity 3.2 cd/lm  
 LEDs/each optic 1  
 Light colour/type White

Required components:

C13186\_LENINA-STD-BASE-CXA15  
 C12606\_LENINA-DL

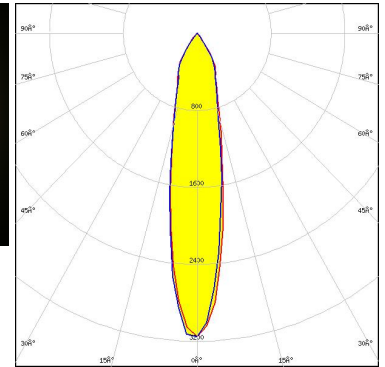

Light distribution files



LED CXA/B 1816 & CXA/B 1820 & CXA 1850  
 FWHM / FWTM 26.0° / 73.0°  
 Efficiency 92 %  
 Peak intensity 2.6 cd/lm  
 LEDs/each optic 1  
 Light colour/type White

Required components:

C13868\_LENINA-STD-BASE-VERO13-18  
 Bender Wirth: 437 Typ L1

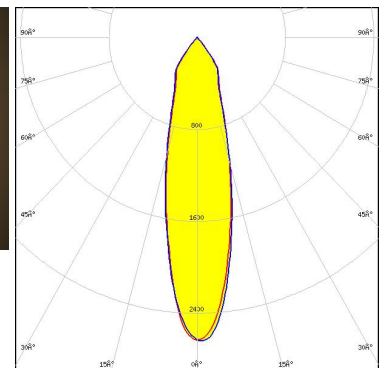
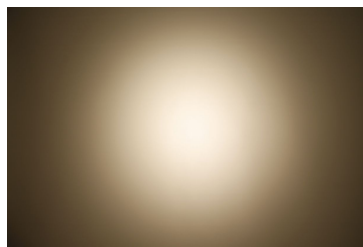

Light distribution files



LED CXA/B 1816 & CXA/B 1820 & CXA 1850  
 FWHM / FWTM 21.0° / 72.0°  
 Efficiency 92 %  
 Peak intensity 3.9 cd/lm  
 LEDs/each optic 1  
 Light colour/type White

Required components:

C14146\_LENINA-STD-BASE-CXA18

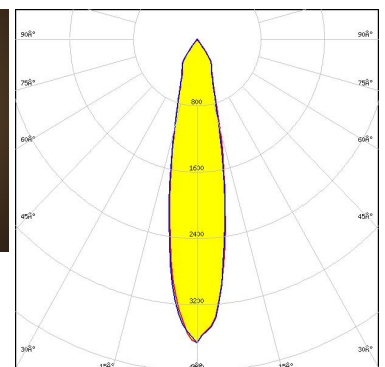
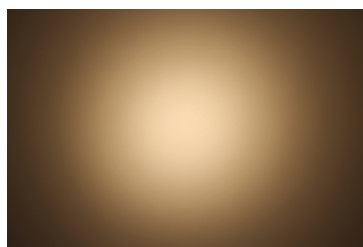

Light distribution files

### OPTICAL RESULTS (MEASURED):



LED CXA/B 1816 & CXA/B 1820 & CXA 1850  
 FWHM / FWTM 29.0° / 73.0°  
 Efficiency 88 %  
 Peak intensity 2.1 cd/lm  
 LEDs/each optic 1  
 Light colour/type White  
 Required components:  
 C13868\_LENINA-STD-BASE-VERO13-18  
 C12606\_LENINA-DL  
 Bender Wirth: 437 Typ L1

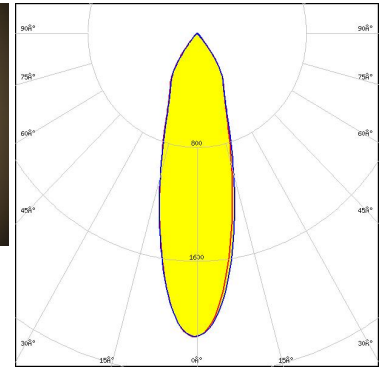
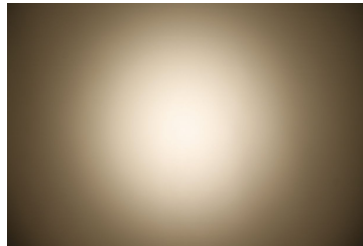

Light distribution files



LED CXA/B 1830  
 FWHM / FWTM 33.0° / 74.0°  
 Efficiency 88 %  
 Peak intensity 1.9 cd/lm  
 LEDs/each optic 1  
 Light colour/type White  
 Required components:  
 C13868\_LENINA-STD-BASE-VERO13-18  
 C12606\_LENINA-DL  
 Bender Wirth: 437 Typ L1

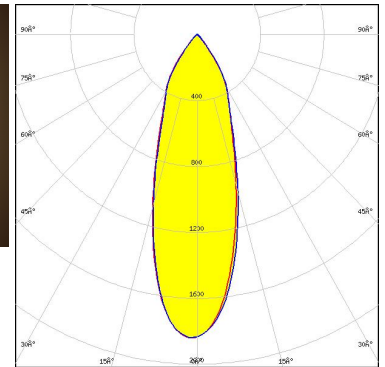
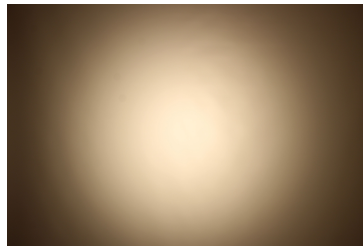

Light distribution files



LED CXA/B 1830  
 FWHM / FWTM 30.0° / 74.0°  
 Efficiency 93 %  
 Peak intensity 2.3 cd/lm  
 LEDs/each optic 1  
 Light colour/type White  
 Required components:  
 C13868\_LENINA-STD-BASE-VERO13-18  
 Bender Wirth: 437 Typ L1

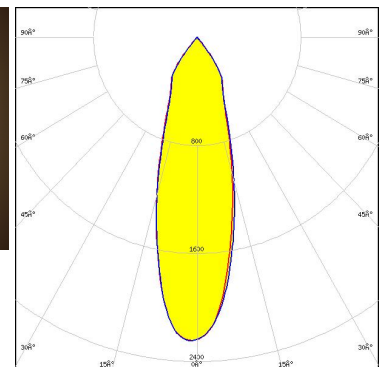
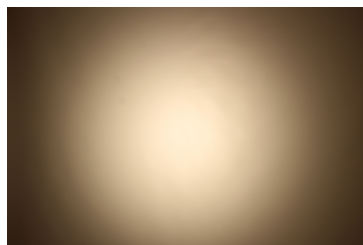

Light distribution files

### OPTICAL RESULTS (MEASURED):



LED CXA/B 25xx  
 FWHM / FWTM 35.0° / 74.0°  
 Efficiency 78 %  
 Peak intensity 1.6 cd/lm  
 LEDs/each optic 1  
 Light colour/type White

Required components:

C13324\_LENINA-STD-BASE-CXA25  
 C12606\_LENINA-DL

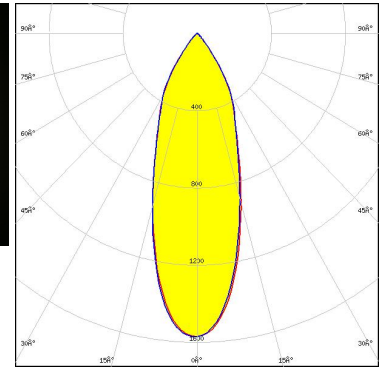
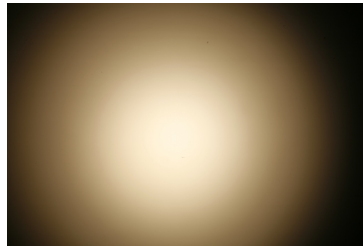

Light distribution files



LED CXA/B 25xx  
 FWHM / FWTM 33.0° / 74.0°  
 Efficiency 86 %  
 Peak intensity 1.9 cd/lm  
 LEDs/each optic 1  
 Light colour/type White

Required components:

C13324\_LENINA-STD-BASE-CXA25

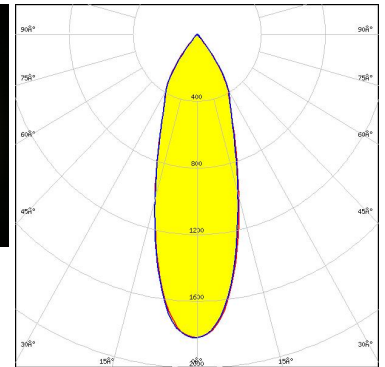
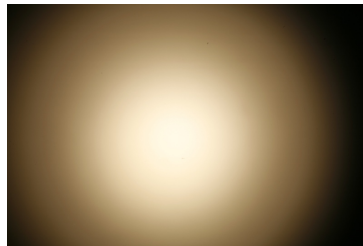

Light distribution files



LED CXA2011  
 FWHM / FWTM 28.0° / 73.0°  
 Efficiency 85 %  
 Peak intensity 2.2 cd/lm  
 LEDs/each optic 1  
 Light colour/type White

Required components:

C12105\_LENINA-STD-BASE-CXA20

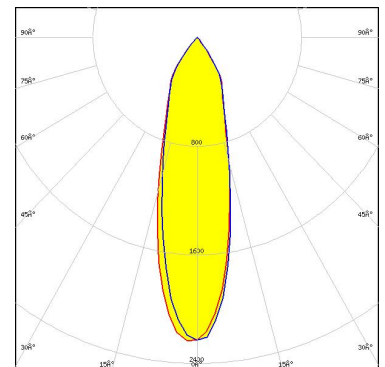

Light distribution files

### OPTICAL RESULTS (MEASURED):



LED CXA2011  
FWHM / FWTM 33.0° / 76.0°  
Efficiency 77 %  
Peak intensity 1.8 cd/lm  
LEDs/each optic 1  
Light colour/type White

Required components:

C12105\_LENINA-STD-BASE-CXA20  
C12606\_LENINA-DL

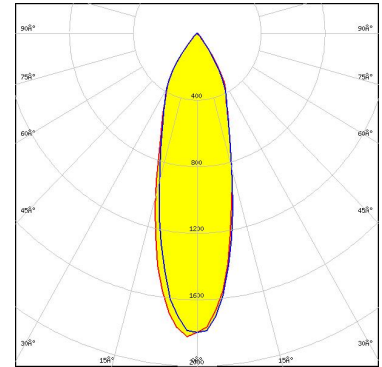

Light distribution files



LED CHI3030 19W  
FWHM / FWTM 39.0° / 80.0°  
Efficiency 91 %  
Peak intensity 1.5 cd/lm  
LEDs/each optic 1  
Light colour/type White

Required components:

C13867\_LENINA-STD-BASE-VERO29  
C12606\_LENINA-DL  
Bender Wirth: 468 Typ L3

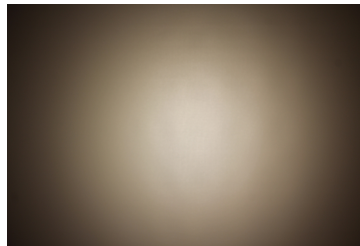

Light distribution files



LED CHI3030 29W  
FWHM / FWTM 47.0° / 84.0°  
Efficiency 87 %  
Peak intensity 1.2 cd/lm  
LEDs/each optic 1  
Light colour/type White

Required components:

C13867\_LENINA-STD-BASE-VERO29  
C12606\_LENINA-DL  
Bender Wirth: 468 Typ L3

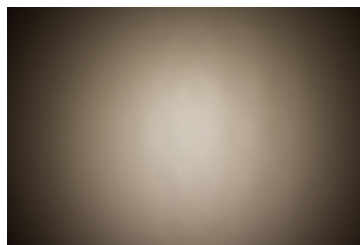

Light distribution files

### OPTICAL RESULTS (MEASURED):



**LED** LUXEON CoB 1202/1203  
**FWHM / FWTM** 22.0° / 71.0°  
**Efficiency** 92 %  
**Peak intensity** 3.1 cd/lm  
**LEDs/each optic** 1  
**Light colour/type** White  
**Required components:**  
 C13868\_LENINA-STD-BASE-VERO13-18  
 Bender Wirth: 438 Typ L1

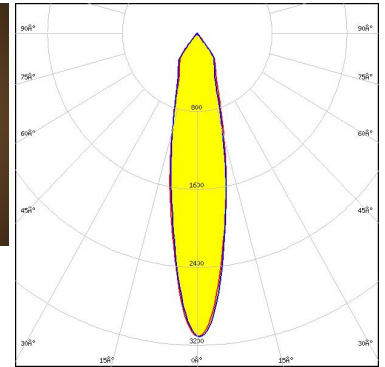
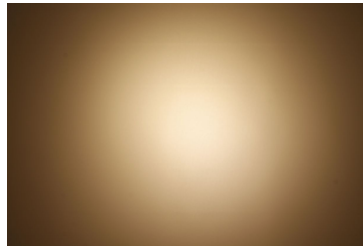

Light distribution files



**LED** LUXEON CoB 1202/1203  
**FWHM / FWTM** 26.0° / 71.0°  
**Efficiency** 88 %  
**Peak intensity** 2.4 cd/lm  
**LEDs/each optic** 1  
**Light colour/type** White  
**Required components:**  
 C13868\_LENINA-STD-BASE-VERO13-18  
 C12606\_LENINA-DL  
 Bender Wirth: 438 Typ L1

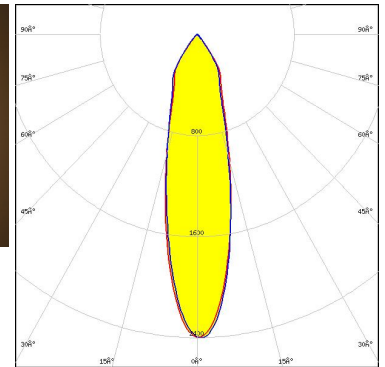
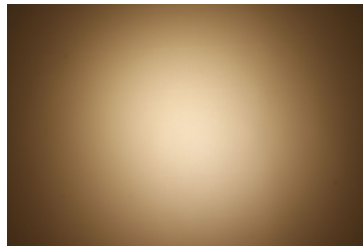

Light distribution files



**LED** LUXEON CoB 1204/1205  
**FWHM / FWTM** 30.0° / 74.0°  
**Efficiency** 82 %  
**Peak intensity** 1.8 cd/lm  
**LEDs/each optic** 1  
**Light colour/type** White  
**Required components:**  
 C12292\_LENINA-STD-BASE-MEZ  
 C12606\_LENINA-DL

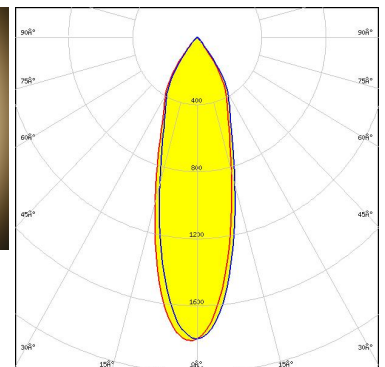

Light distribution files

### OPTICAL RESULTS (MEASURED):



LED LUXEON CoB 1204/1205  
FWHM / FWTM 28.0° / 74.0°  
Efficiency 87 %  
Peak intensity 2.2 cd/lm  
LEDs/each optic 1  
Light colour/type White  
Required components:  
C12292\_LENINA-STD-BASE-MEZ

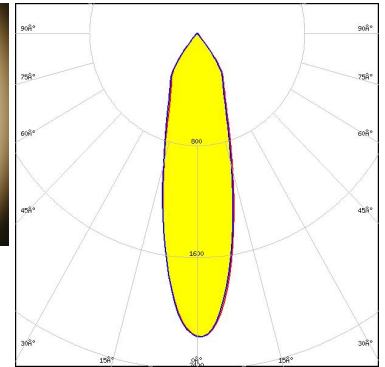

Light distribution files



LED LUXEON CoB 1204HD  
FWHM / FWTM 20.0° / 65.0°  
Efficiency 92 %  
Peak intensity 3.5 cd/lm  
LEDs/each optic 1  
Light colour/type White  
Required components:  
C11981\_LENINA-STD-BASE-COB-L110

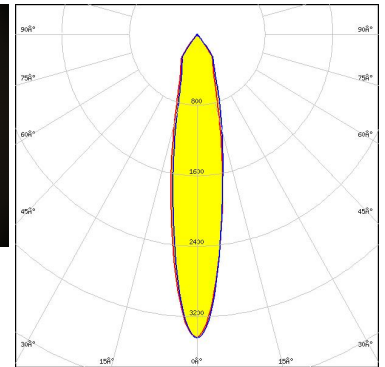
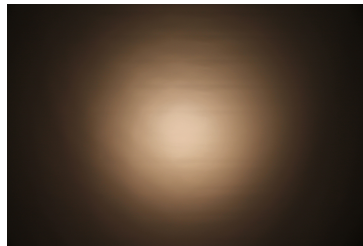

Light distribution files



LED LUXEON CoB 1205HD  
FWHM / FWTM 23.0° / 70.0°  
Efficiency 92 %  
Peak intensity 3 cd/lm  
LEDs/each optic 1  
Light colour/type White  
Required components:  
C11981\_LENINA-STD-BASE-COB-L110

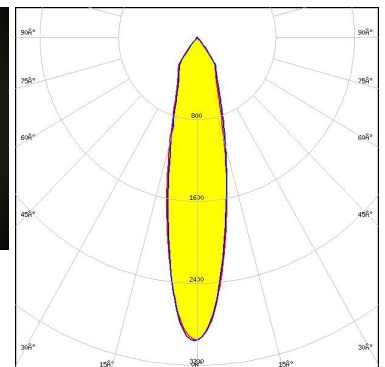
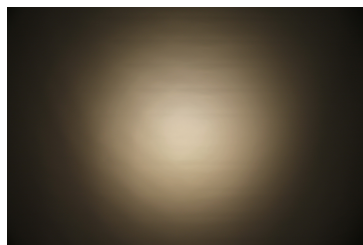

Light distribution files



#### OPTICAL RESULTS (MEASURED):



LED LUXEON CoB 1208  
 FWHM / FWTM 31.0° / 75.0°  
 Efficiency 88 %  
 Peak intensity 2 cd/lm  
 LEDs/each optic 1  
 Light colour/type White  
 Required components:  
 C12292\_LENINA-STD-BASE-MEZ

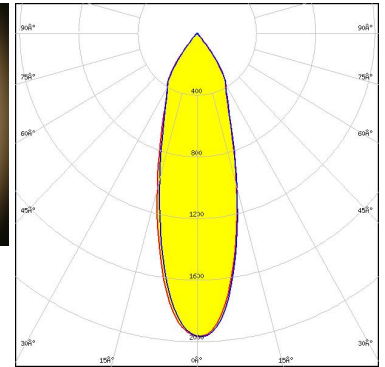

Light distribution files



LED LUXEON CoB 1208  
 FWHM / FWTM 33.0° / 75.0°  
 Efficiency 83 %  
 Peak intensity 1.7 cd/lm  
 LEDs/each optic 1  
 Light colour/type White  
 Required components:  
 C12292\_LENINA-STD-BASE-MEZ  
 C12606\_LENINA-DL

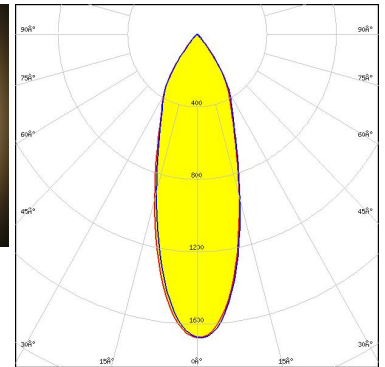

Light distribution files



LED LUXEON CoB 1211  
 FWHM / FWTM 37.0° / 77.0°  
 Efficiency 87 %  
 Peak intensity 1.6 cd/lm  
 LEDs/each optic 1  
 Light colour/type White  
 Required components:  
 C13867\_LENINA-STD-BASE-VERO29  
 C12606\_LENINA-DL  
 Bender Wirth: 431 Typ L3

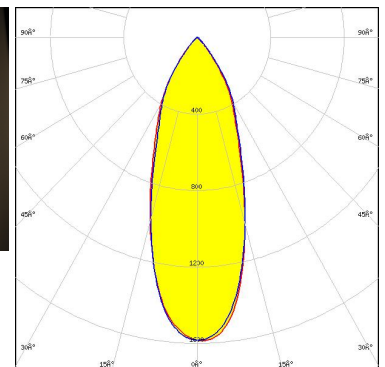
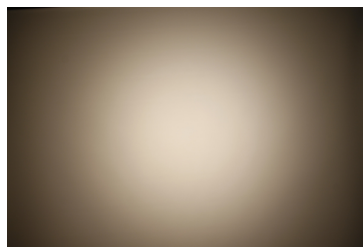

Light distribution files

### OPTICAL RESULTS (MEASURED):



LED LUXEON CoB 1211  
 FWHM / FWTM 35.0° / 76.0°  
 Efficiency 93 %  
 Peak intensity 1.9 cd/lm  
 LEDs/each optic 1  
 Light colour/type White  
 Required components:  
 C13867\_LENINA-STD-BASE-VERO29  
 Bender Wirth: 431 Typ L3

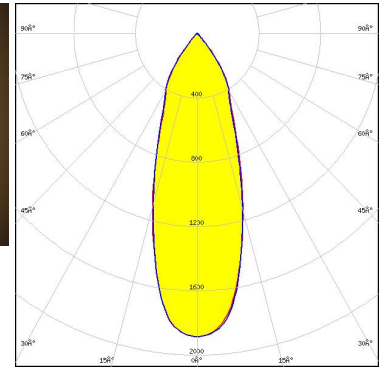
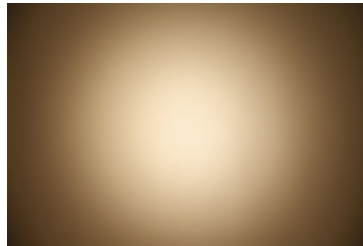

Light distribution files



LED LUXEON CoB 1213/1216/1812  
 FWHM / FWTM 39.0° / 76.0°  
 Efficiency 92 %  
 Peak intensity 1.7 cd/lm  
 LEDs/each optic 1  
 Light colour/type White  
 Required components:  
 C12692\_LENINA-STD-BASE-CLL040

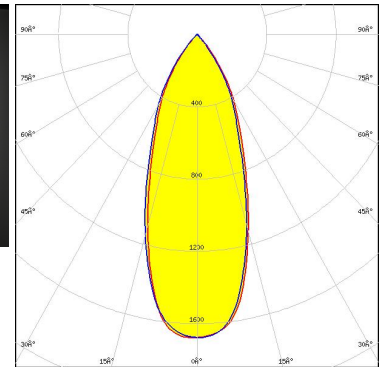
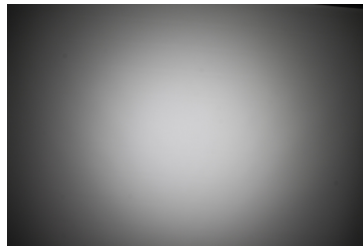

Light distribution files



LED LUXEON CoB 1213/1216/1812  
 FWHM / FWTM 40.0° / 77.0°  
 Efficiency 88 %  
 Peak intensity 1.5 cd/lm  
 LEDs/each optic 1  
 Light colour/type White  
 Required components:  
 C12692\_LENINA-STD-BASE-CLL040  
 C12606\_LENINA-DL

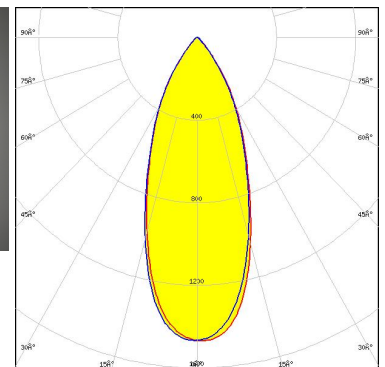

Light distribution files

### OPTICAL RESULTS (MEASURED):



LED LUXEON CoB 1213/1216/1812  
 FWHM / FWTM 38.0° / 77.0°  
 Efficiency 85 %  
 Peak intensity 1.6 cd/lm  
 LEDs/each optic 1  
 Light colour/type White  
 Required components:  
 A.A.G. STUCCHI: 8102-G2 + S-8000-12

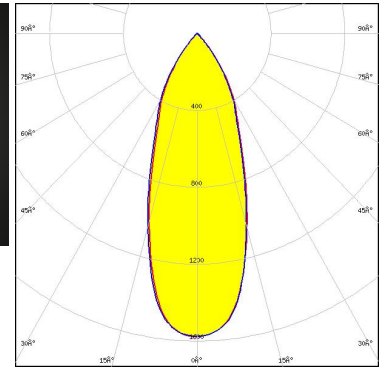
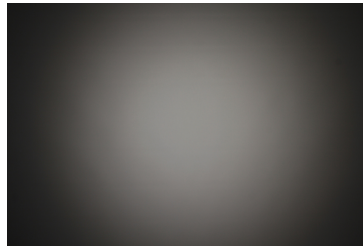

Light distribution files



LED LUXEON CoB 1213/1216/1812  
 FWHM / FWTM 39.0° / 77.0°  
 Efficiency 81 %  
 Peak intensity 1.4 cd/lm  
 LEDs/each optic 1  
 Light colour/type White  
 Required components:  
 C12606\_LENINA-DL  
 A.A.G. STUCCHI: 8102-G2 + S-8000-12

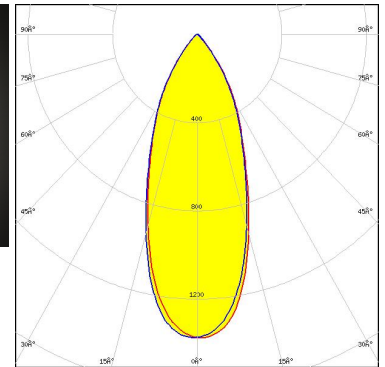
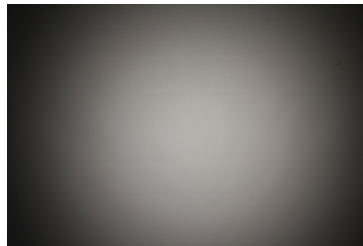

Light distribution files



LED LUXEON K12  
 FWHM / FWTM 28.0° / 74.0°  
 Efficiency 89 %  
 Peak intensity 2.3 cd/lm  
 LEDs/each optic 1  
 Light colour/type White  
 Required components:  
 C12924\_LENINA-STD-BASE-LUXEON-K

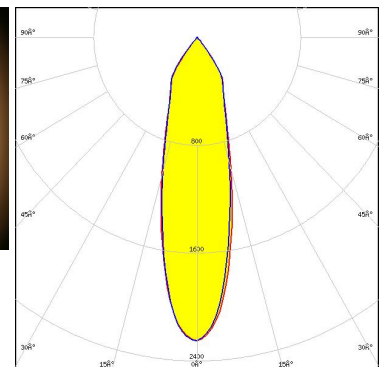
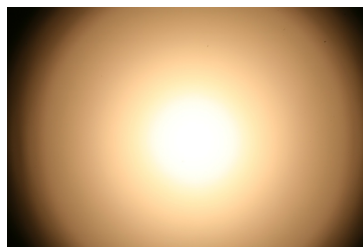

Light distribution files

### OPTICAL RESULTS (MEASURED):



**LED** LUXEON K12  
**FWHM / FWTM** 30.0° / 73.0°  
**Efficiency** 83 %  
**Peak intensity** 1.9 cd/lm  
**LEDs/each optic** 1  
**Light colour/type** White  
**Required components:**  
 C12924\_LENINA-STD-BASE-LUXEON-K  
 C12606\_LENINA-DL

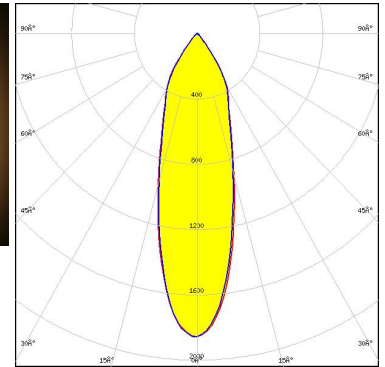

Light distribution files



**LED** LUXEON K16  
**FWHM / FWTM** 34.0° / 75.0°  
**Efficiency** 79 %  
**Peak intensity** 1.5 cd/lm  
**LEDs/each optic** 1  
**Light colour/type** White  
**Required components:**  
 C12924\_LENINA-STD-BASE-LUXEON-K  
 C12606\_LENINA-DL

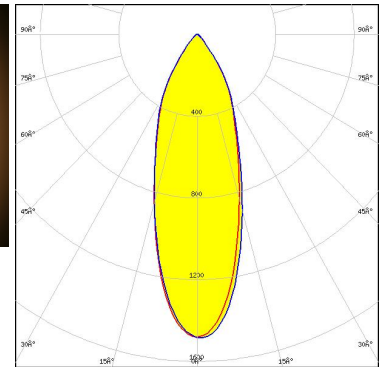

Light distribution files



**LED** LUXEON K16  
**FWHM / FWTM** 30.0° / 74.0°  
**Efficiency** 85 %  
**Peak intensity** 2 cd/lm  
**LEDs/each optic** 1  
**Light colour/type** White  
**Required components:**  
 C12924\_LENINA-STD-BASE-LUXEON-K

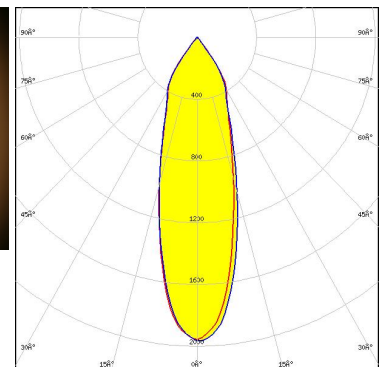
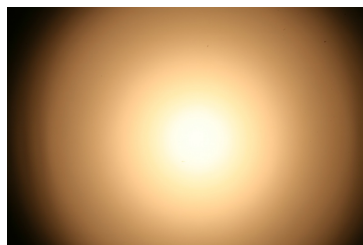

Light distribution files

### OPTICAL RESULTS (MEASURED):



**LED** CDM-14 (Dim-To-Warm)  
**FWHM / FWTM** 31.0° / 74.0°  
**Efficiency** 88 %  
**Peak intensity** 1.9 cd/lm  
**LEDs/each optic** 1  
**Light colour/type** White  
**Required components:**  
 C13868\_LENINA-STD-BASE-VERO13-18  
 C12606\_LENINA-DL  
 Bender Wirth: 491 Typ L2

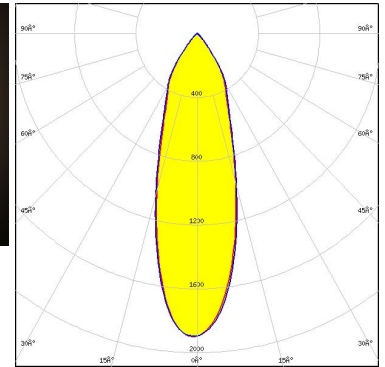
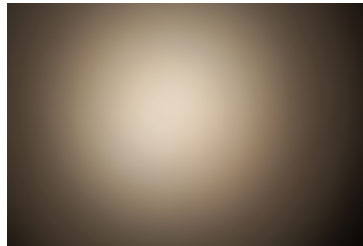

Light distribution files



**LED** CDM-14 (Dim-To-Warm)  
**FWHM / FWTM** 29.0° / 74.0°  
**Efficiency** 92 %  
**Peak intensity** 2.3 cd/lm  
**LEDs/each optic** 1  
**Light colour/type** White  
**Required components:**  
 C13868\_LENINA-STD-BASE-VERO13-18  
 Bender Wirth: 491 Typ L2

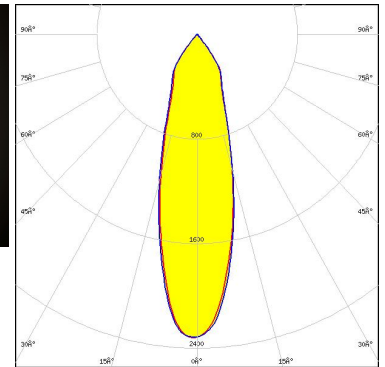
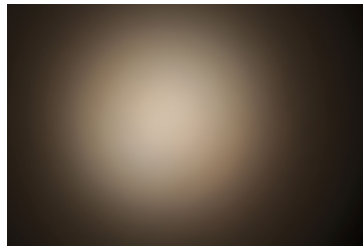

Light distribution files



**LED** CDM-18 (Dim-To-Warm)  
**FWHM / FWTM** 36.0° / 76.0°  
**Efficiency** 88 %  
**Peak intensity** 1.7 cd/lm  
**LEDs/each optic** 1  
**Light colour/type** White  
**Required components:**  
 C13868\_LENINA-STD-BASE-VERO13-18  
 C12606\_LENINA-DL  
 Bender Wirth: 491 Typ L2

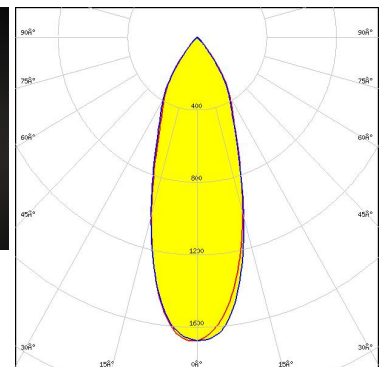
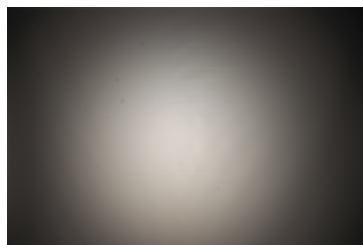

Light distribution files

#### OPTICAL RESULTS (MEASURED):



LED CDM-18 (Dim-To-Warm)  
 FWHM / FWTM 34.0° / 75.0°  
 Efficiency 92 %  
 Peak intensity 2 cd/lm  
 LEDs/each optic 1  
 Light colour/type White  
 Required components:  
 C13868\_LENINA-STD-BASE-VERO13-18  
 Bender Wirth: 491 Typ L2

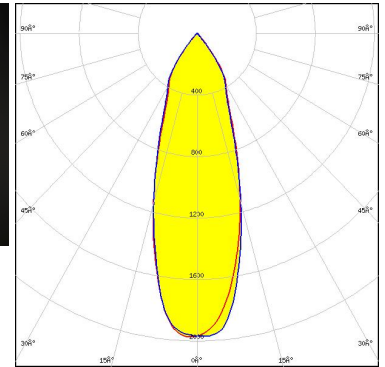
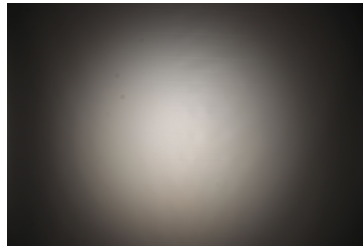

Light distribution files



LED CDM-9 (Dim-To-Warm)  
 FWHM / FWTM 24.0° / 72.0°  
 Efficiency 92 %  
 Peak intensity 2.9 cd/lm  
 LEDs/each optic 1  
 Light colour/type White  
 Required components:  
 C13868\_LENINA-STD-BASE-VERO13-18  
 Bender Wirth: 490 Typ L1

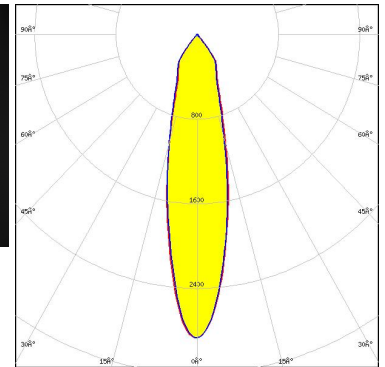
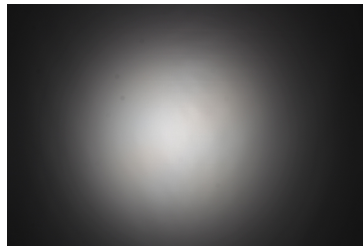

Light distribution files



LED CDM-9 (Dim-To-Warm)  
 FWHM / FWTM 27.0° / 72.0°  
 Efficiency 87 %  
 Peak intensity 2.2 cd/lm  
 LEDs/each optic 1  
 Light colour/type White  
 Required components:  
 C13868\_LENINA-STD-BASE-VERO13-18  
 C12606\_LENINA-DL  
 Bender Wirth: 490 Typ L1

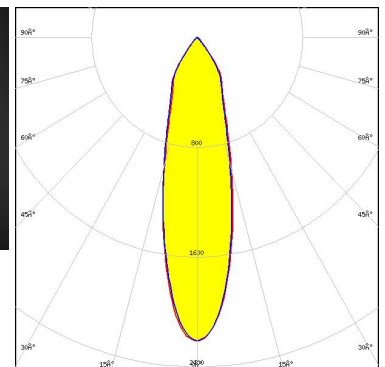
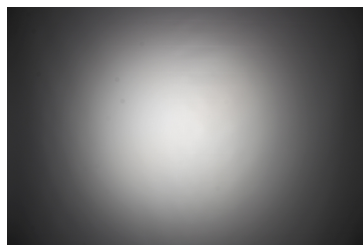

Light distribution files

### OPTICAL RESULTS (MEASURED):



LED CTM-14 (Tunable White)  
 FWHM / FWTM 28.0° / 74.0°  
 Efficiency 92 %  
 Peak intensity 2.4 cd/lm  
 LEDs/each optic 1  
 Light colour/type White  
 Required components:  
 C13867\_LENINA-STD-BASE-VERO29  
 Bender Wirth: 442 Typ L3

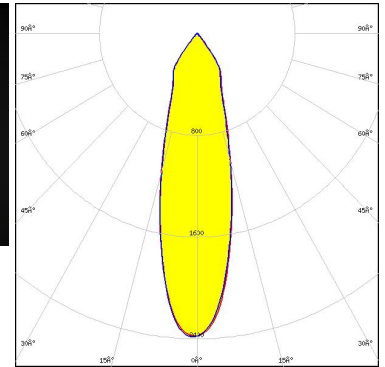
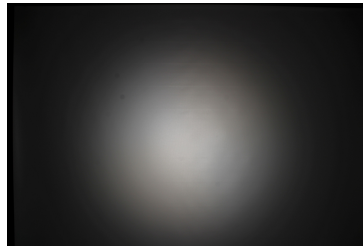

Light distribution files



LED CTM-14 (Tunable White)  
 FWHM / FWTM 31.0° / 74.0°  
 Efficiency 87 %  
 Peak intensity 1.9 cd/lm  
 LEDs/each optic 1  
 Light colour/type White  
 Required components:  
 C13867\_LENINA-STD-BASE-VERO29  
 C12606\_LENINA-DL  
 Bender Wirth: 442 Typ L3

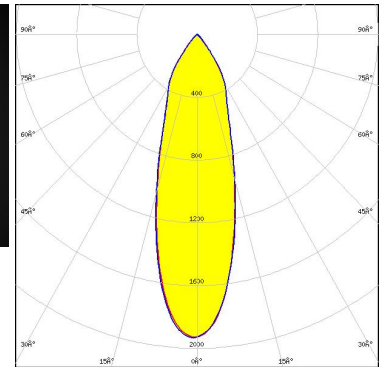
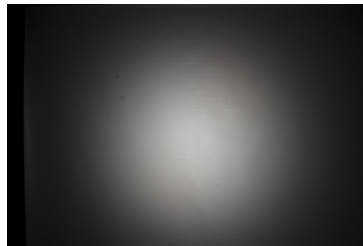

Light distribution files



LED CTM-18 (Tunable White)  
 FWHM / FWTM 32.0° / 76.0°  
 Efficiency 92 %  
 Peak intensity 2 cd/lm  
 LEDs/each optic 1  
 Light colour/type White  
 Required components:  
 C13867\_LENINA-STD-BASE-VERO29  
 Bender Wirth: 442 Typ L3

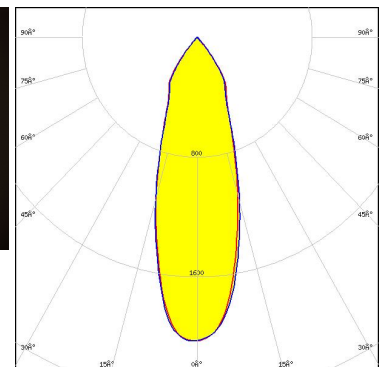
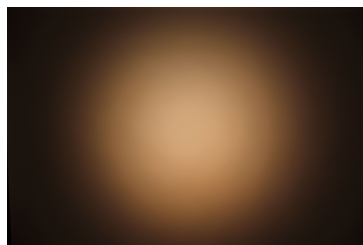

Light distribution files

### OPTICAL RESULTS (MEASURED):



**LED** CTM-18 (Tunable White)  
**FWHM / FWTM** 34.0° / 76.0°  
**Efficiency** 87 %  
**Peak intensity** 1.7 cd/lm  
**LEDs/each optic** 1  
**Light colour/type** White  
**Required components:**  
 C13867\_LENINA-STD-BASE-VERO29  
 C12606\_LENINA-DL  
 Bender Wirth: 442 Typ L3

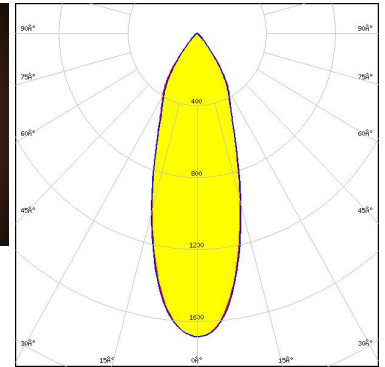

Light distribution files



**LED** CTM-22 (Tunable White)  
**FWHM / FWTM** 39.0° / 79.0°  
**Efficiency** 92 %  
**Peak intensity** 1.6 cd/lm  
**LEDs/each optic** 1  
**Light colour/type** White  
**Required components:**  
 C13867\_LENINA-STD-BASE-VERO29  
 Bender Wirth: 494 Typ L3

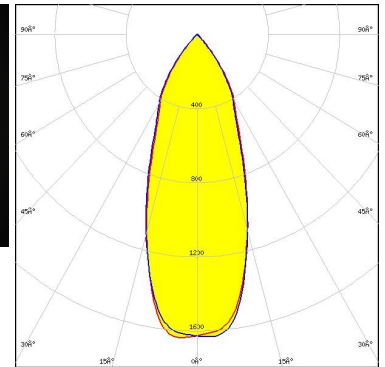
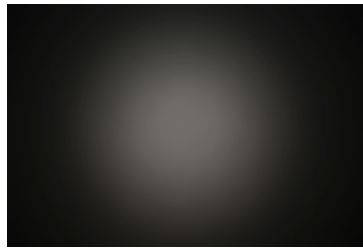

Light distribution files



**LED** CTM-22 (Tunable White)  
**FWHM / FWTM** 40.0° / 79.0°  
**Efficiency** 87 %  
**Peak intensity** 1.4 cd/lm  
**LEDs/each optic** 1  
**Light colour/type** White  
**Required components:**  
 C13867\_LENINA-STD-BASE-VERO29  
 C12606\_LENINA-DL  
 Bender Wirth: 494 Typ L3

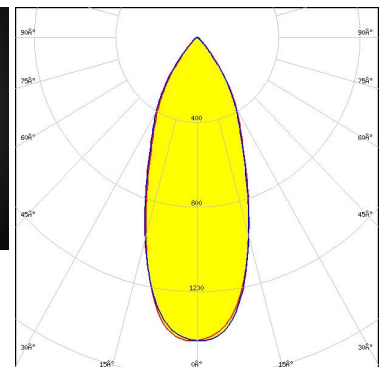
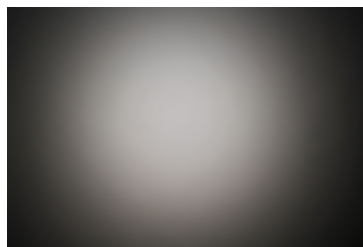

Light distribution files



### OPTICAL RESULTS (MEASURED):



LED CxM-14 (19x19)  
FWHM / FWTM 28.0° / 72.0°  
Efficiency 93 %  
Peak intensity 2.5 cd/lm  
LEDs/each optic 1  
Light colour/type White  
Required components:  
C12691\_LENINA-STD-BASE-CLL030

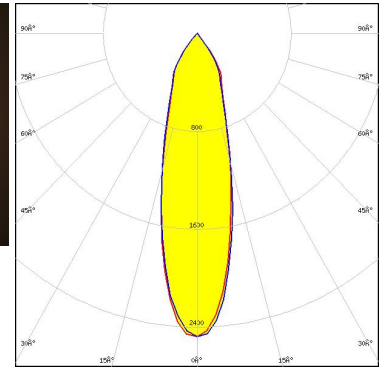
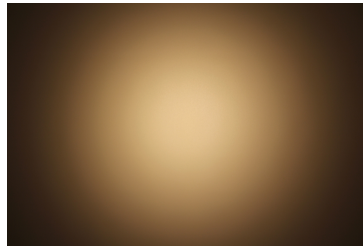

Light distribution files



LED CxM-14 (19x19)  
FWHM / FWTM 31.0° / 73.0°  
Efficiency 89 %  
Peak intensity 2.1 cd/lm  
LEDs/each optic 1  
Light colour/type White  
Required components:  
C12691\_LENINA-STD-BASE-CLL030  
C12606\_LENINA-DL

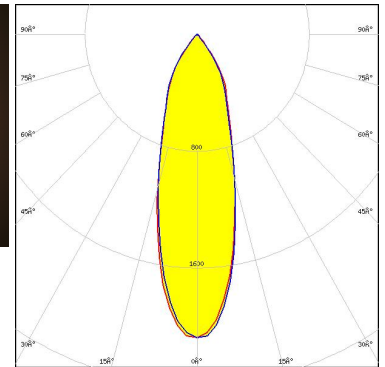
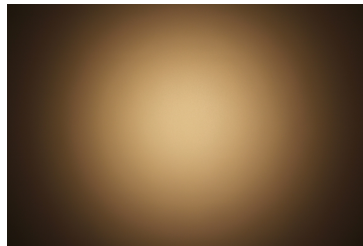

Light distribution files



LED CxM-22 (28x28)  
FWHM / FWTM 39.0° / 80.0°  
Efficiency 92 %  
Peak intensity 1.8 cd/lm  
LEDs/each optic 1  
Light colour/type White  
Required components:  
C12692\_LENINA-STD-BASE-CLL040

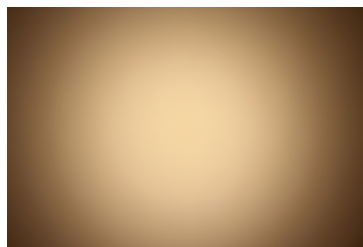

Light distribution files

### OPTICAL RESULTS (MEASURED):



LED CxM-22 (28x28)  
FWHM / FWTM 40.0° / 80.0°  
Efficiency 89 %  
Peak intensity 1.6 cd/lm  
LEDs/each optic 1  
Light colour/type White

Required components:

C12692\_LENINA-STD-BASE-CLL040  
C12606\_LENINA-DL



Light distribution files



LED COB J-Type  
FWHM / FWTM 32.0° / 74.0°  
Efficiency 89 %  
Peak intensity 1.9 cd/lm  
LEDs/each optic 1  
Light colour/type White

Required components:

C13868\_LENINA-STD-BASE-VERO13-18  
C12606\_LENINA-DL

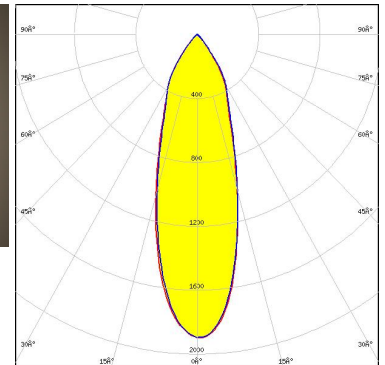
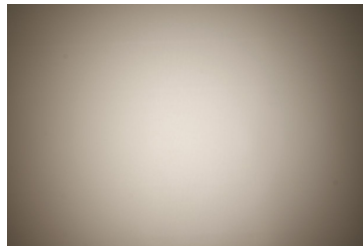

Light distribution files



LED COB J-Type  
FWHM / FWTM 33.0° / 75.0°  
Efficiency 81 %  
Peak intensity 1.6 cd/lm  
LEDs/each optic 1  
Light colour/type White

Required components:

C12292\_LENINA-STD-BASE-MEZ  
C12606\_LENINA-DL

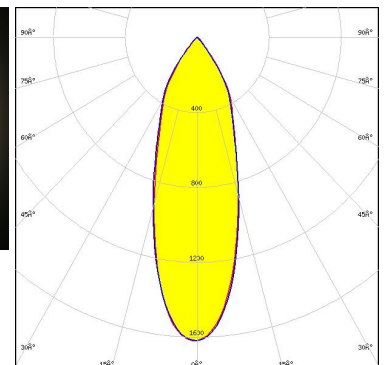
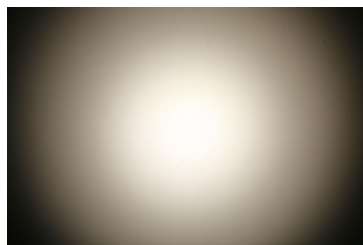

Light distribution files

### OPTICAL RESULTS (MEASURED):



**LED** COB J-Type  
**FWHM / FWTM** 29.0° / 74.0°  
**Efficiency** 93 %  
**Peak intensity** 2.3 cd/lm  
**LEDs/each optic** 1  
**Light colour/type** White  
**Required components:**  
 C13868\_LENINA-STD-BASE-VERO13-18  
 Bender Wirth: 463 Typ L2

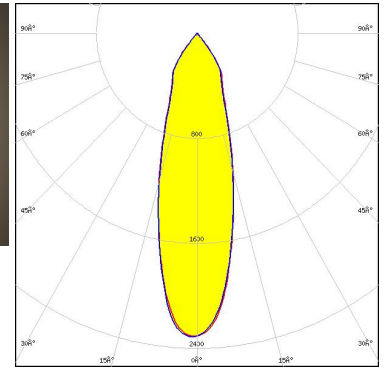
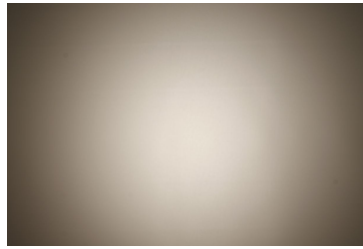

Light distribution files



**LED** COB J-Type  
**FWHM / FWTM** 31.0° / 75.0°  
**Efficiency** 86 %  
**Peak intensity** 1.9 cd/lm  
**LEDs/each optic** 1  
**Light colour/type** White  
**Required components:**  
 C12292\_LENINA-STD-BASE-MEZ

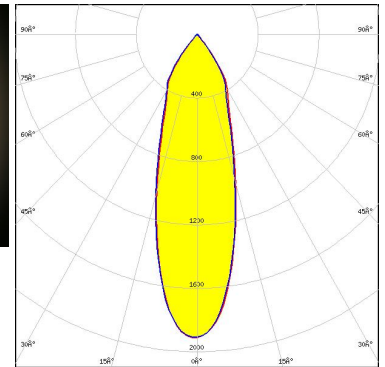

Light distribution files



**LED** COB L-Type (LES 11)  
**FWHM / FWTM** 29.0° / 73.0°  
**Efficiency** 79 %  
**Peak intensity** 1.8 cd/lm  
**LEDs/each optic** 1  
**Light colour/type** White  
**Required components:**  
 C11981\_LENINA-STD-BASE-COB-L110  
 C12606\_LENINA-DL

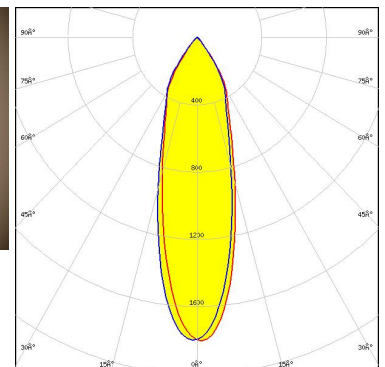
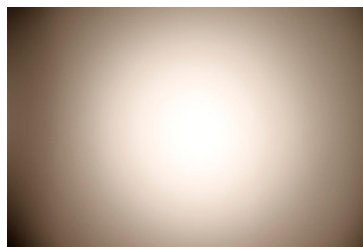

Light distribution files

### OPTICAL RESULTS (MEASURED):



**LED** COB L-Type (LES 11)  
**FWHM / FWTM** 28.0° / 72.0°  
**Efficiency** 87 %  
**Peak intensity** 2.2 cd/lm  
**LEDs/each optic** 1  
**Light colour/type** White  
**Required components:**  
 C13868\_LENINA-STD-BASE-VERO13-18  
 C12606\_LENINA-DL  
 Bender Wirth: 438 Typ L1

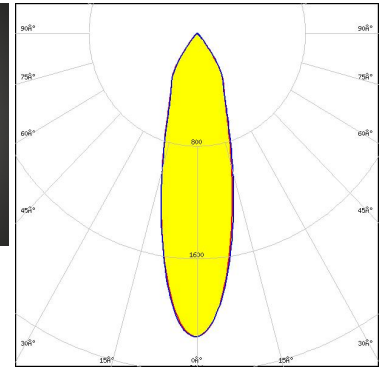
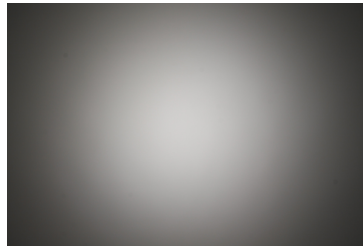

Light distribution files



**LED** COB L-Type (LES 11)  
**FWHM / FWTM** 27.0° / 74.0°  
**Efficiency** 84 %  
**Peak intensity** 2.2 cd/lm  
**LEDs/each optic** 1  
**Light colour/type** White  
**Required components:**  
 C11981\_LENINA-STD-BASE-COB-L110

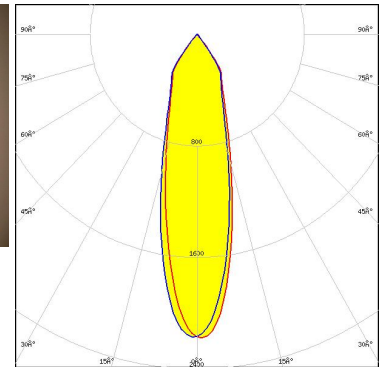
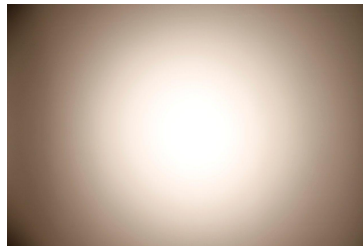

Light distribution files



**LED** COB L-Type (LES 11)  
**FWHM / FWTM** 25.0° / 72.0°  
**Efficiency** 91 %  
**Peak intensity** 2.7 cd/lm  
**LEDs/each optic** 1  
**Light colour/type** White  
**Required components:**  
 C13868\_LENINA-STD-BASE-VERO13-18  
 Bender Wirth: 438 Typ L1

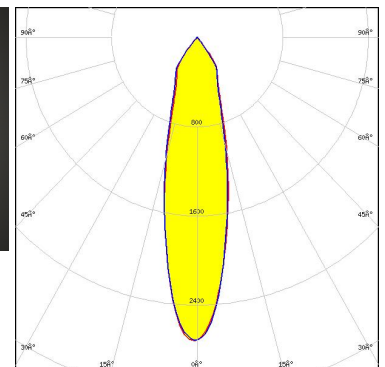
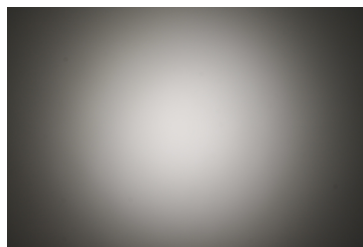

Light distribution files

### OPTICAL RESULTS (MEASURED):



LED COB L-Type (LES 9)  
 FWHM / FWTM 26.0° / 71.0°  
 Efficiency 89 %  
 Peak intensity 2.4 cd/lm  
 LEDs/each optic 1  
 Light colour/type White  
 Required components:  
 C13868\_LENINA-STD-BASE-VERO13-18  
 C12606\_LENINA-DL  
 Bender Wirth: 438 Typ L1

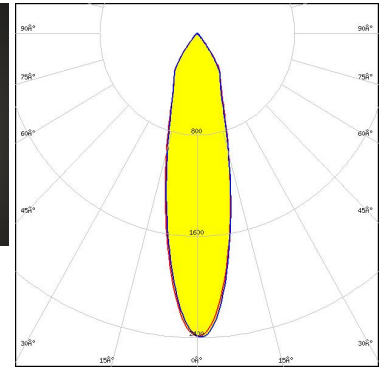
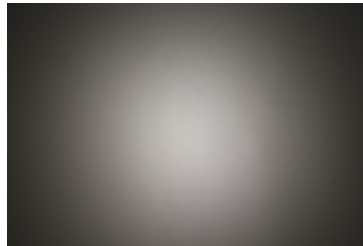

Light distribution files



LED NVCWJ024Z-V1MT: COB J-Type Tunable White  
 FWHM / FWTM 29.0° / 73.0°  
 Efficiency 87 %  
 Peak intensity 2 cd/lm  
 LEDs/each optic 1  
 Light colour/type White  
 Required components:  
 C13868\_LENINA-STD-BASE-VERO13-18  
 C12606\_LENINA-DL  
 Bender Wirth: 498 Typ L2

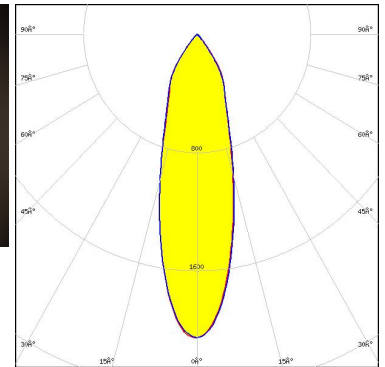
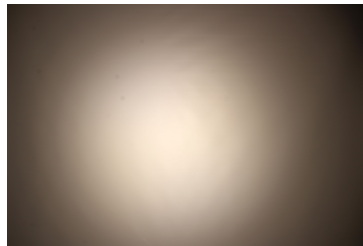

Light distribution files



LED NVCWJ024Z-V1MT: COB J-Type Tunable White  
 FWHM / FWTM 26.0° / 73.0°  
 Efficiency 92 %  
 Peak intensity 2.6 cd/lm  
 LEDs/each optic 1  
 Light colour/type White  
 Required components:  
 C13868\_LENINA-STD-BASE-VERO13-18  
 Bender Wirth: 498 Typ L2

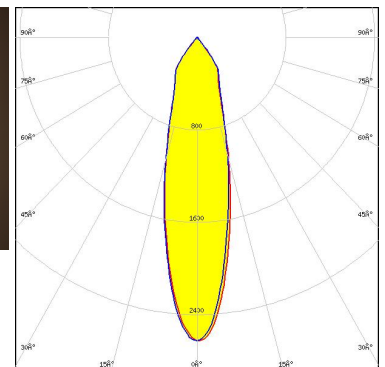
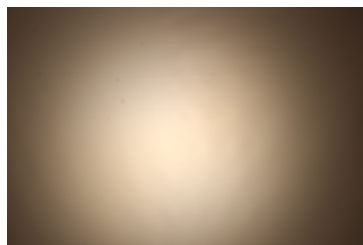

Light distribution files

### OPTICAL RESULTS (MEASURED):

**OSRAM**  
Opto Semiconductors

LED Soleriq S13  
FWHM / FWTM 30.0° / 73.0°  
Efficiency 87 %  
Peak intensity 2 cd/lm  
LEDs/each optic 1  
Light colour/type White

Required components:

C13868\_LENINA-STD-BASE-VERO13-18

C12606\_LENINA-DL

Bender Wirth: 437 Typ L1

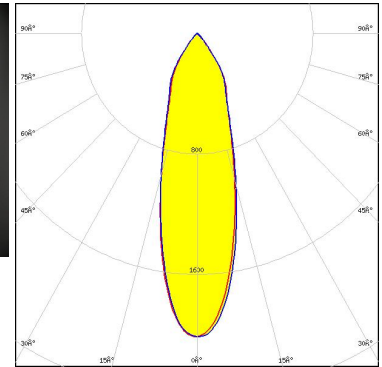
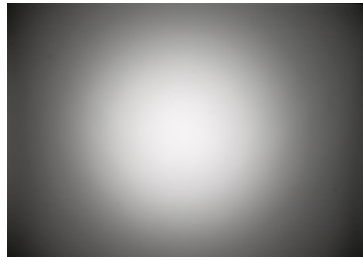

Light distribution files

**OSRAM**  
Opto Semiconductors

LED Soleriq S13  
FWHM / FWTM 27.0° / 73.0°  
Efficiency 91 %  
Peak intensity 2.6 cd/lm  
LEDs/each optic 1  
Light colour/type White

Required components:

C13868\_LENINA-STD-BASE-VERO13-18

Bender Wirth: 437 Typ L1

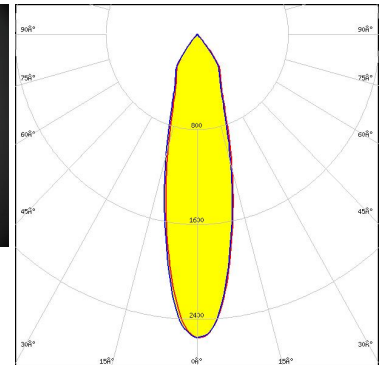
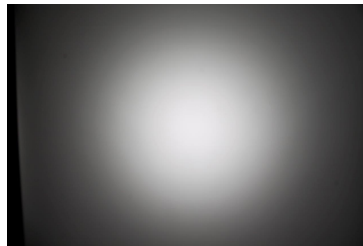

Light distribution files

**OSRAM**  
Opto Semiconductors

LED Soleriq S19  
FWHM / FWTM 32.0° / 76.0°  
Efficiency 93 %  
Peak intensity 2 cd/lm  
LEDs/each optic 1  
Light colour/type White

Required components:

C13867\_LENINA-STD-BASE-VERO29

Bender Wirth: 462 Typ L3

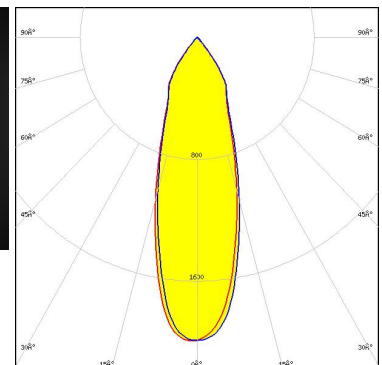
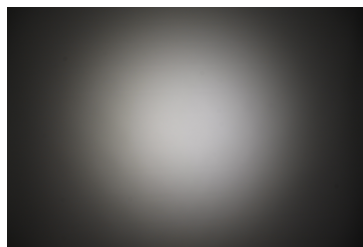

Light distribution files

#### OPTICAL RESULTS (MEASURED):

**OSRAM**  
Opto Semiconductors

LED Soleriq S19  
FWHM / FWTM 34.0° / 76.0°  
Efficiency 89 %  
Peak intensity 1.7 cd/lm  
LEDs/each optic 1  
Light colour/type White

Required components:

C13867\_LENINA-STD-BASE-VERO29

C12606\_LENINA-DL

Bender Wirth: 462 Typ L3

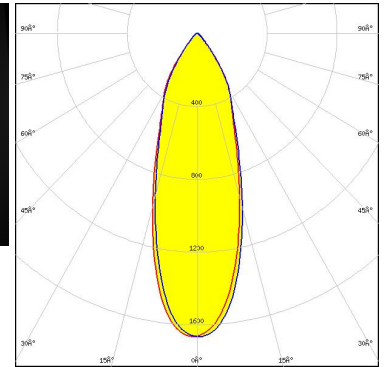
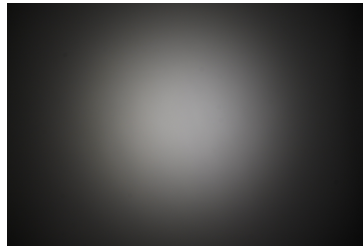

Light distribution files

**PHILIPS**

LED Fortimo SLM L13 CoB  
FWHM / FWTM 30.0° / 72.0°  
Efficiency 86 %  
Peak intensity 2 cd/lm  
LEDs/each optic 1  
Light colour/type White

Required components:

C12292\_LENINA-STD-BASE-MEZ

C12606\_LENINA-DL

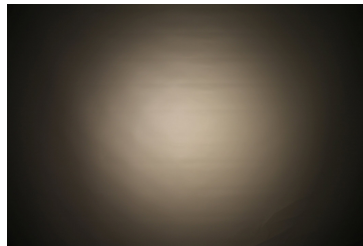

Light distribution files

**PHILIPS**

LED Fortimo SLM L13 CoB  
FWHM / FWTM 27.0° / 72.0°  
Efficiency 93 %  
Peak intensity 2.6 cd/lm  
LEDs/each optic 1  
Light colour/type White

Required components:

C12292\_LENINA-STD-BASE-MEZ

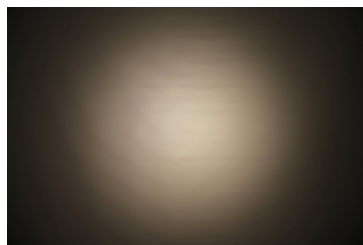

Light distribution files

### OPTICAL RESULTS (MEASURED):

#### PHILIPS

LED Fortimo SLM L15 CoB  
 FWHM / FWTM 32.0° / 74.0°  
 Efficiency 86 %  
 Peak intensity 1.8 cd/lm  
 LEDs/each optic 1  
 Light colour/type White  
 Required components:  
 C12292\_LENINA-STD-BASE-MEZ  
 C12606\_LENINA-DL

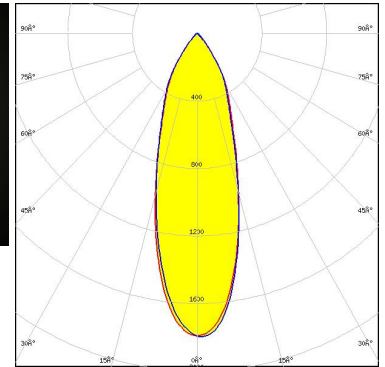
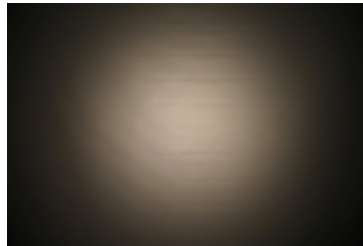

Light distribution files

#### PHILIPS

LED Fortimo SLM L15 CoB  
 FWHM / FWTM 29.0° / 73.0°  
 Efficiency %  
 Peak intensity 2.3 cd/lm  
 LEDs/each optic 1  
 Light colour/type White  
 Required components:  
 C12292\_LENINA-STD-BASE-MEZ

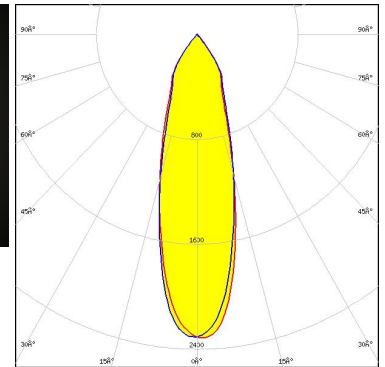
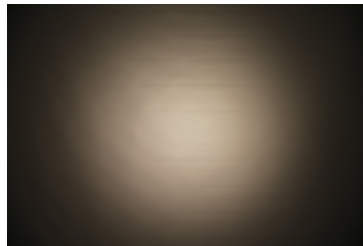

Light distribution files

#### PHILIPS

LED Fortimo SLM L19 CoB  
 FWHM / FWTM 33.0° / 74.0°  
 Efficiency 92 %  
 Peak intensity 2 cd/lm  
 LEDs/each optic 1  
 Light colour/type White  
 Required components:  
 C12692\_LENINA-STD-BASE-CLL040

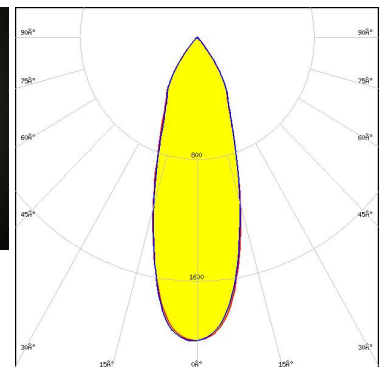
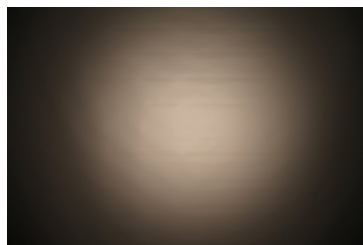

Light distribution files



### OPTICAL RESULTS (MEASURED):

#### PHILIPS

LED Fortimo SLM L19 CoB  
FWHM / FWTM 35.0° / 75.0°  
Efficiency 86 %  
Peak intensity 1.6 cd/lm  
LEDs/each optic 1  
Light colour/type White  
Required components:  
C12692\_LENINA-STD-BASE-CLL040  
C12606\_LENINA-DL

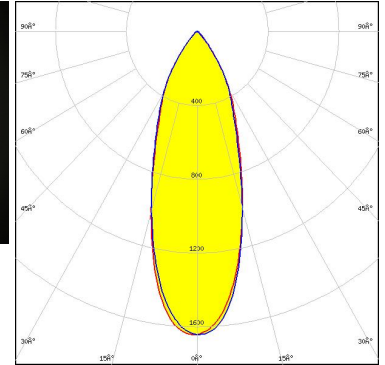

Light distribution files

#### PHILIPS

LED Fortimo SLM L23 CoB  
FWHM / FWTM 40.0° / 77.0°  
Efficiency 86 %  
Peak intensity 1.4 cd/lm  
LEDs/each optic 1  
Light colour/type White  
Required components:  
C12692\_LENINA-STD-BASE-CLL040  
C12606\_LENINA-DL

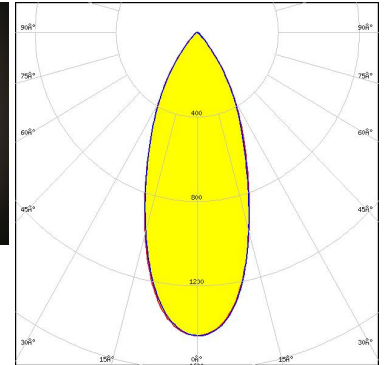

Light distribution files

#### PHILIPS

LED Fortimo SLM L23 CoB  
FWHM / FWTM 39.0° / 76.0°  
Efficiency 92 %  
Peak intensity 1.7 cd/lm  
LEDs/each optic 1  
Light colour/type White  
Required components:  
C12692\_LENINA-STD-BASE-CLL040

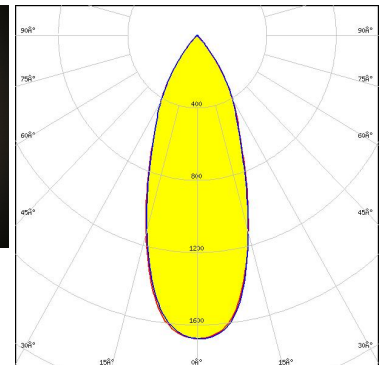
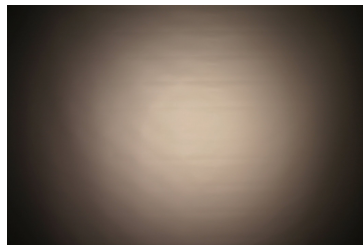

Light distribution files

### OPTICAL RESULTS (MEASURED):

#### SAMSUNG

LED LC016D / LC019D / LC026D / LC033D  
FWHM / FWTM 33.0° / 75.0°  
Efficiency 87 %  
Peak intensity 1.8 cd/lm  
LEDs/each optic 1  
Light colour/type White  
Required components:  
C12691\_LENINA-STD-BASE-CLL030  
C12606\_LENINA-DL

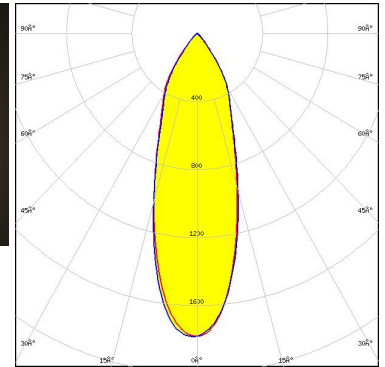
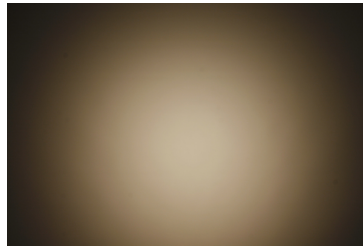

Light distribution files

#### SAMSUNG

LED LC016D / LC019D / LC026D / LC033D  
FWHM / FWTM 30.0° / 74.0°  
Efficiency 92 %  
Peak intensity 2.2 cd/lm  
LEDs/each optic 1  
Light colour/type White  
Required components:  
C12691\_LENINA-STD-BASE-CLL030

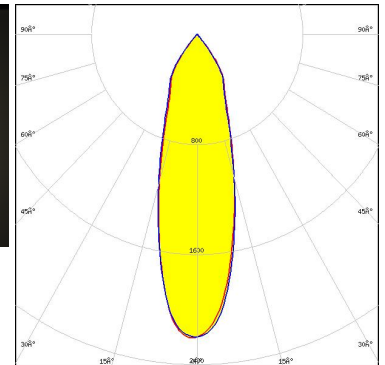
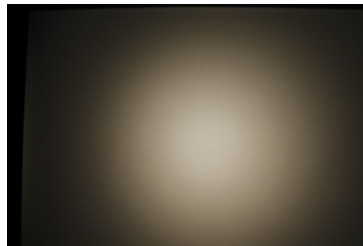

Light distribution files

#### SAMSUNG

LED LC026B / 033B / 040B  
FWHM / FWTM 35.0° / 76.0°  
Efficiency 88 %  
Peak intensity 1.7 cd/lm  
LEDs/each optic 1  
Light colour/type White  
Required components:  
C13868\_LENINA-STD-BASE-VERO13-18  
C12606\_LENINA-DL  
Bender Wirth: 450 Typ L2

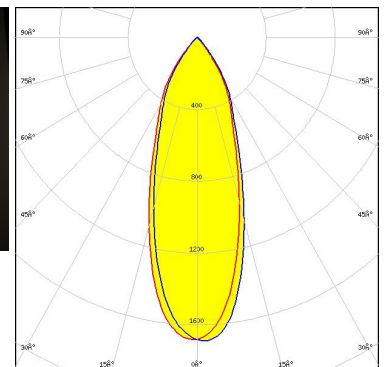
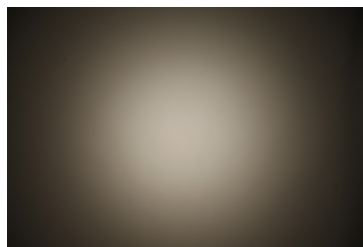

Light distribution files

### OPTICAL RESULTS (MEASURED):

#### SAMSUNG

LED LC026B / 033B / 040B  
 FWHM / FWTM 33.0° / 75.0°  
 Efficiency 92 %  
 Peak intensity 2 cd/lm  
 LEDs/each optic 1  
 Light colour/type White  
 Required components:  
 C13868\_LENINA-STD-BASE-VERO13-18  
 Bender Wirth: 450 Typ L2

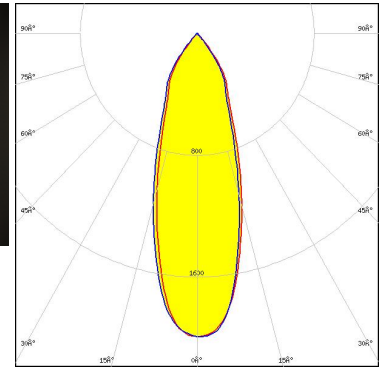
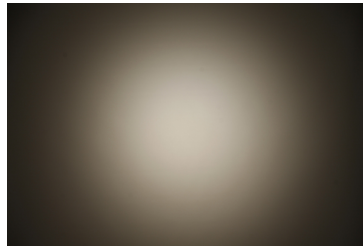

Light distribution files

#### SAMSUNG

LED LC040D / LC060D / LC080D  
 FWHM / FWTM 41.0° / 78.0°  
 Efficiency 87 %  
 Peak intensity 1.4 cd/lm  
 LEDs/each optic 1  
 Light colour/type White  
 Required components:  
 C12692\_LENINA-STD-BASE-CLL040  
 C12606\_LENINA-DL

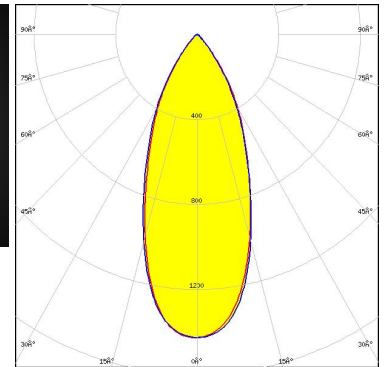
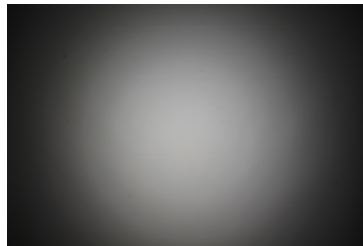

Light distribution files

#### SAMSUNG

LED LC040D / LC060D / LC080D  
 FWHM / FWTM 40.0° / 77.0°  
 Efficiency 91 %  
 Peak intensity 1.6 cd/lm  
 LEDs/each optic 1  
 Light colour/type White  
 Required components:  
 C12692\_LENINA-STD-BASE-CLL040

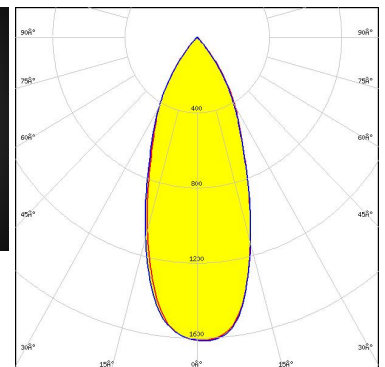
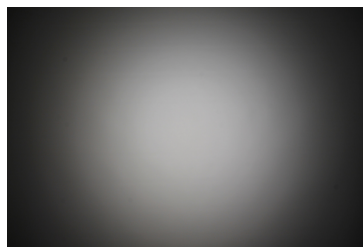

Light distribution files

### OPTICAL RESULTS (MEASURED):

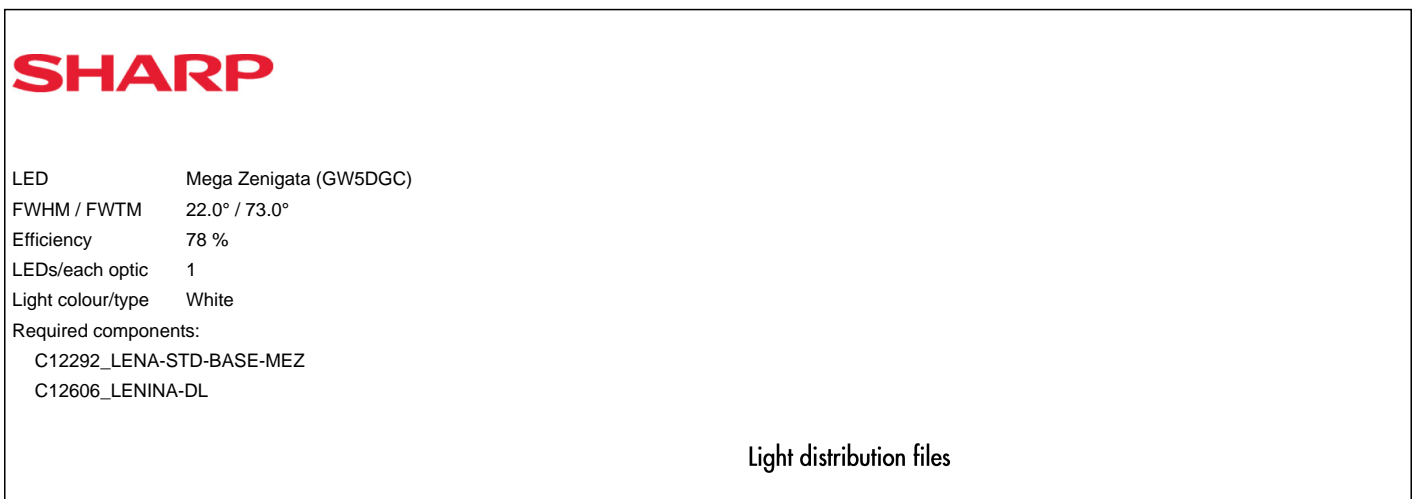
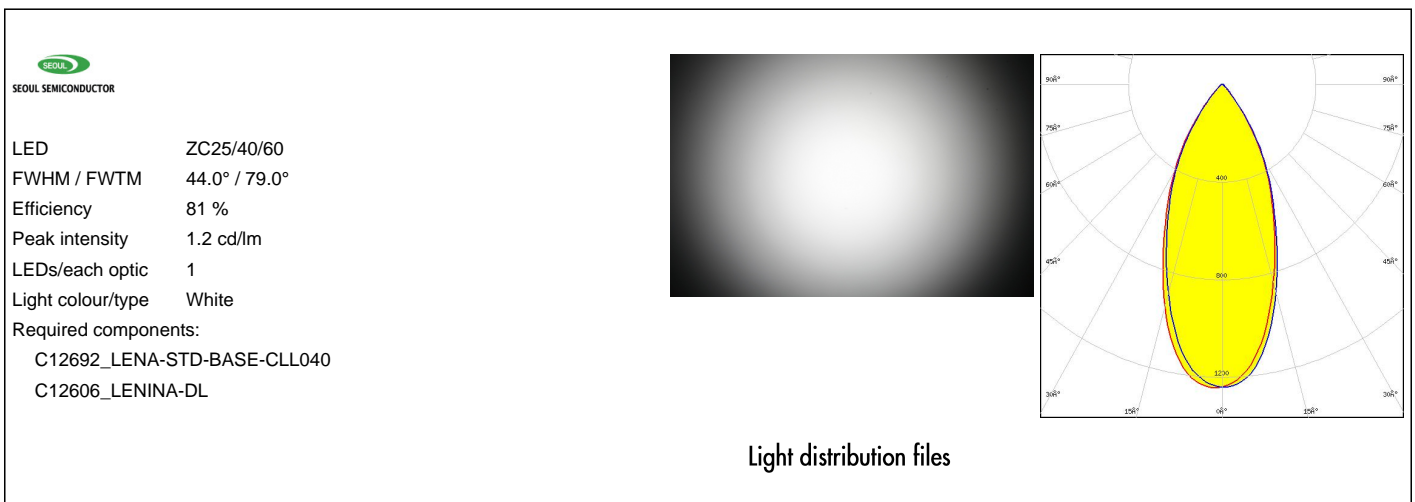
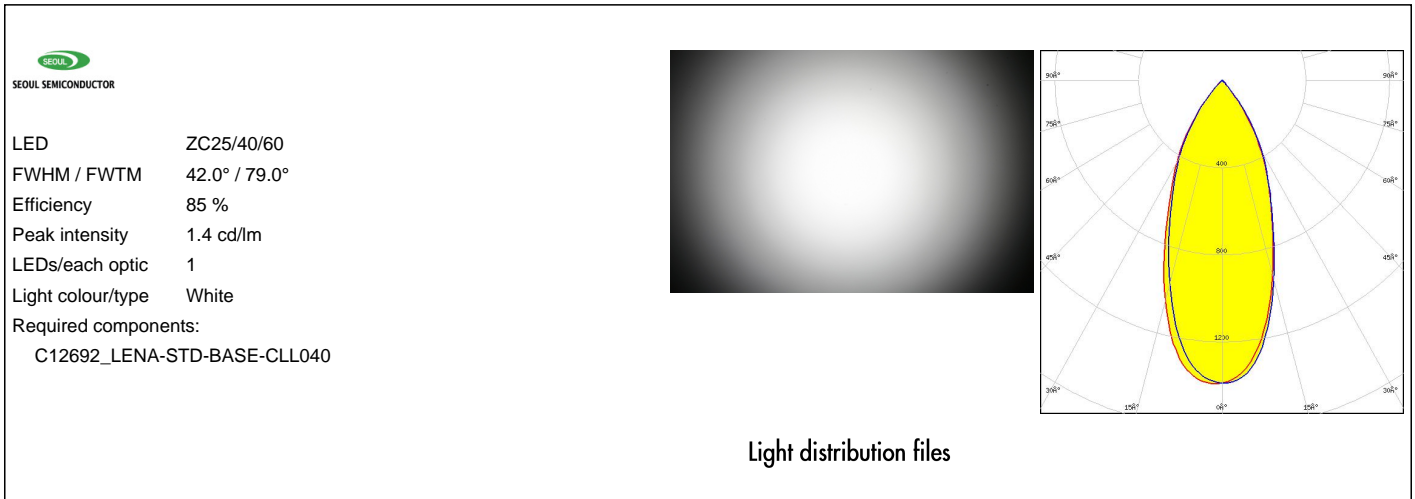

### OPTICAL RESULTS (MEASURED):

## SHARP

LED Mega Zenigata (GW5DGC)  
FWHM / FWTM 21.0° / 72.0°  
Efficiency 86 %  
LEDs/each optic 1  
Light colour/type White  
Required components:  
C12292\_LENINA-STD-BASE-MEZ

Light distribution files

## SHARP

LED Mega Zenigata (GW6DME)  
FWHM / FWTM 32.0° / 74.0°  
Efficiency 82 %  
Peak intensity 1.7 cd/lm  
LEDs/each optic 1  
Light colour/type White  
Required components:  
C12292\_LENINA-STD-BASE-MEZ  
C12606\_LENINA-DL

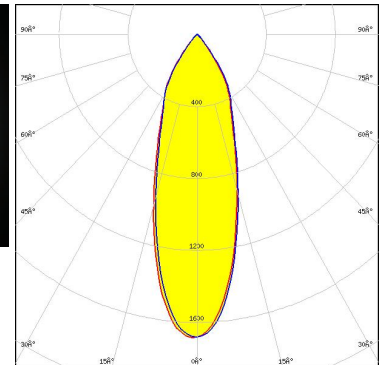
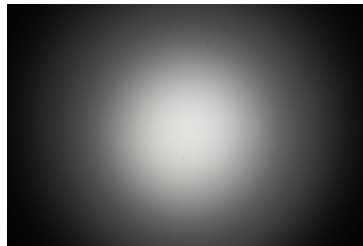

Light distribution files

## SHARP

LED Mega Zenigata (GW6DME)  
FWHM / FWTM 30.0° / 75.0°  
Efficiency 87 %  
Peak intensity 2 cd/lm  
LEDs/each optic 1  
Light colour/type White  
Required components:  
C12292\_LENINA-STD-BASE-MEZ

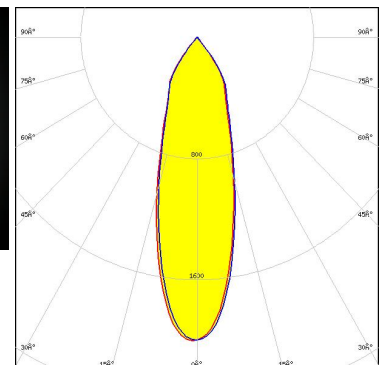
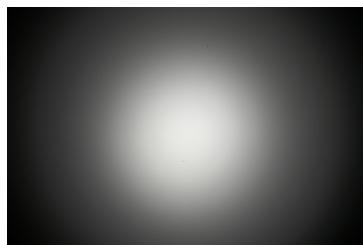

Light distribution files

### OPTICAL RESULTS (MEASURED):

#### TRIDONIC

LED SLE G7 LES15  
FWHM / FWTM 30.0° / 74.0°  
Efficiency 93 %  
Peak intensity 2.3 cd/lm  
LEDs/each optic 1  
Light colour/type White  
Required components:  
C12691\_LENINA-STD-BASE-CLL030

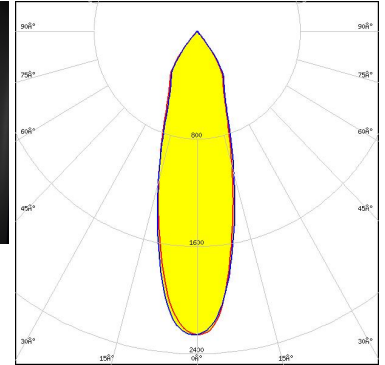

Light distribution files

#### TRIDONIC

LED SLE G7 LES17 H  
FWHM / FWTM 31.0° / 74.0°  
Efficiency 91 %  
Peak intensity 2.1 cd/lm  
LEDs/each optic 1  
Light colour/type White  
Required components:  
C14547\_LENINA-ADAPTER-B

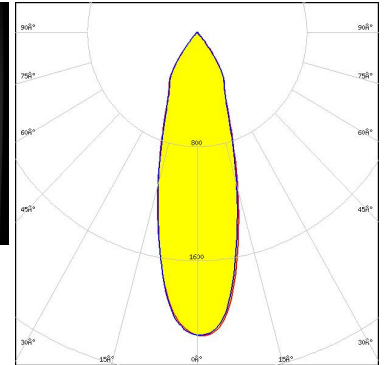

Light distribution files

#### TRIDONIC

LED SLE G7 LES21 H  
FWHM / FWTM 37.0° / 76.0°  
Efficiency 91 %  
Peak intensity 1.7 cd/lm  
LEDs/each optic 1  
Light colour/type White  
Required components:  
C14547\_LENINA-ADAPTER-B

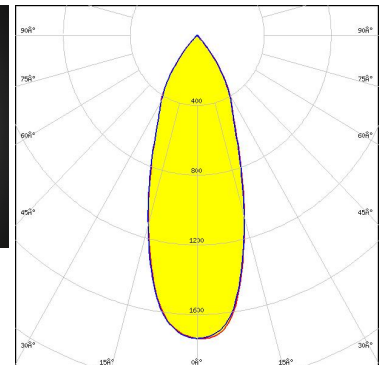
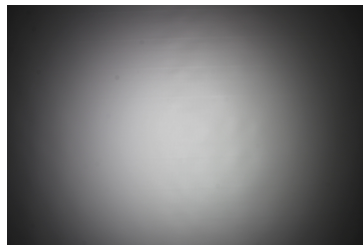

Light distribution files

### OPTICAL RESULTS (MEASURED):

#### XICATO

LED XOB 14.5 mm  
FWHM / FWTM 29.0° / 74.0°  
Efficiency 93 %  
Peak intensity 2.3 cd/lm  
LEDs/each optic 1  
Light colour/type White  
Required components:  
C12691\_LENA-STD-BASE-CLL030

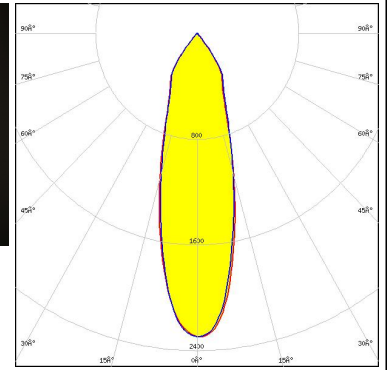

Light distribution files

### OPTICAL RESULTS (SIMULATED):



LED V10 Gen7  
FWHM / FWTM 26.0° / 71.0°  
Efficiency 91 %  
Peak intensity 2.7 cd/lm  
LEDs/each optic 1  
Light colour/type White  
Required components:  
C13868\_LENINA-STD-BASE-VERO13-18

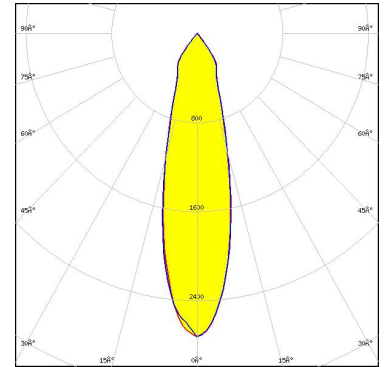

Bender Wirth: 486 Typ L1

Light distribution files



LED V10 Gen7  
FWHM / FWTM 28.0° / 70.0°  
Efficiency 86 %  
Peak intensity 2.3 cd/lm  
LEDs/each optic 1  
Light colour/type White  
Required components:  
C13868\_LENINA-STD-BASE-VERO13-18  
C12606\_LENINA-DL

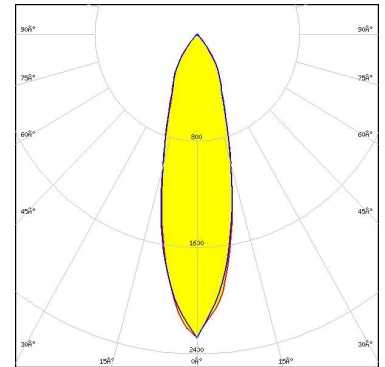

Bender Wirth: 486 Typ L1

Light distribution files



LED V13 Gen7  
FWHM / FWTM 26.0° / 70.0°  
Efficiency 90 %  
Peak intensity 2.6 cd/lm  
LEDs/each optic 1  
Light colour/type White  
Required components:

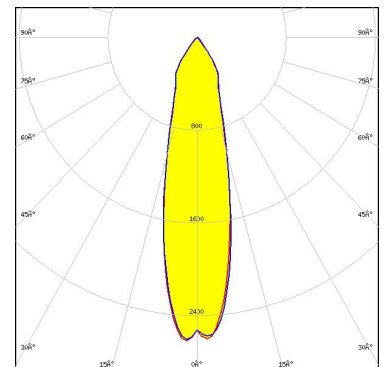

IDEAL: 50-2103CT + 50-2100AN

Light distribution files



### OPTICAL RESULTS (SIMULATED):

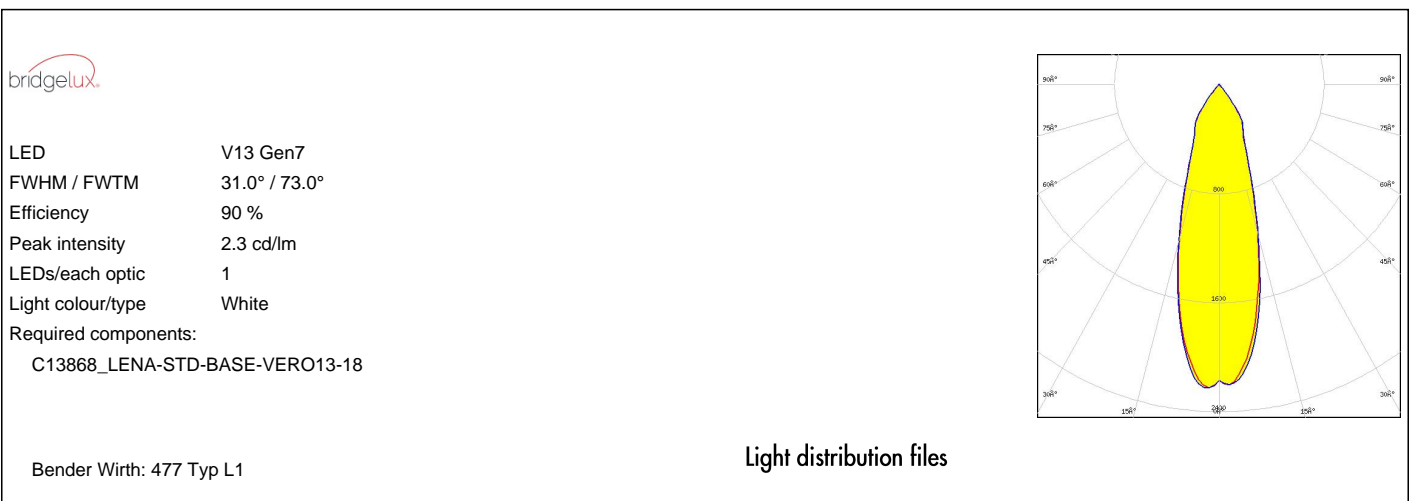
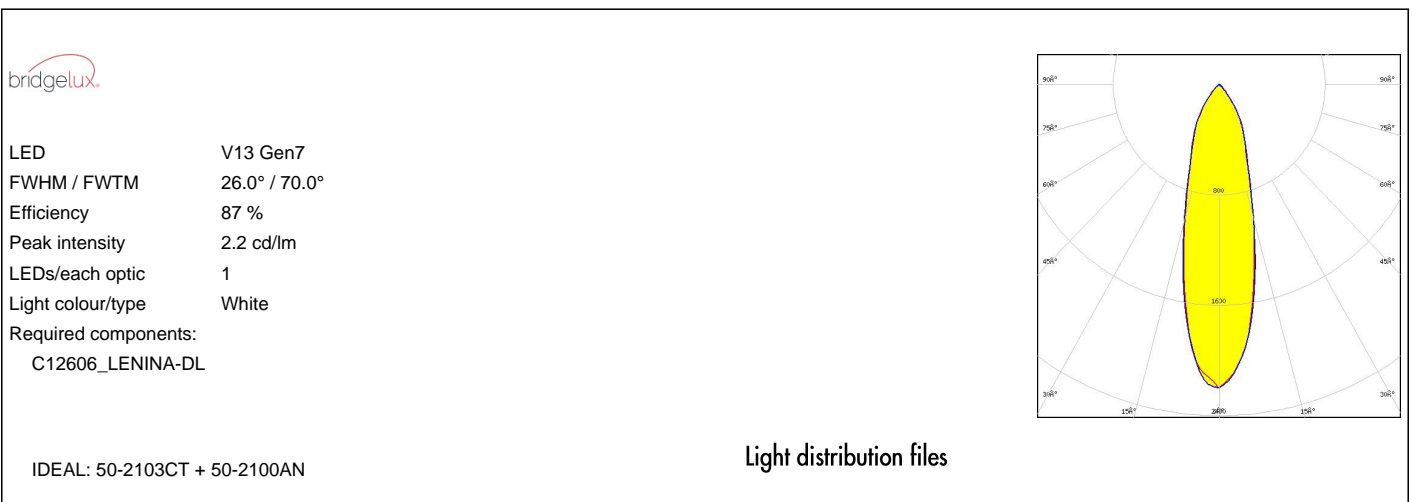
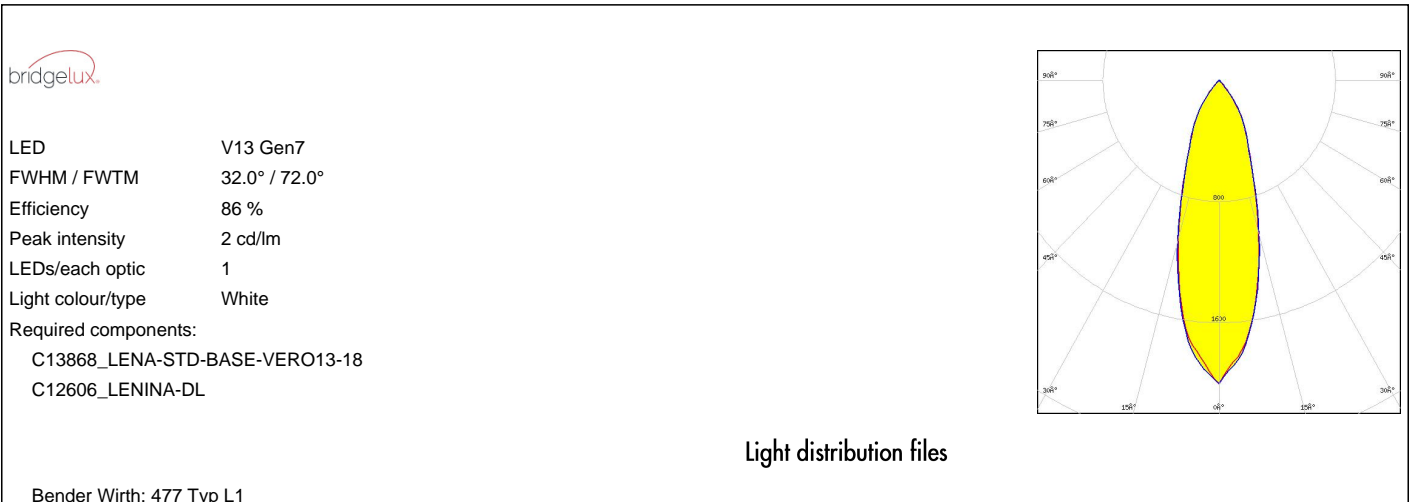

### OPTICAL RESULTS (SIMULATED):



LED V22 Gen 8-9  
 FWHM / FWTM 39.0° / 78.0°  
 Efficiency 90 %  
 Peak intensity 1.6 cd/lm  
 LEDs/each optic 1  
 Light colour/type White

Required components:  
 C13867\_LENINA-STD-BASE-VERO29

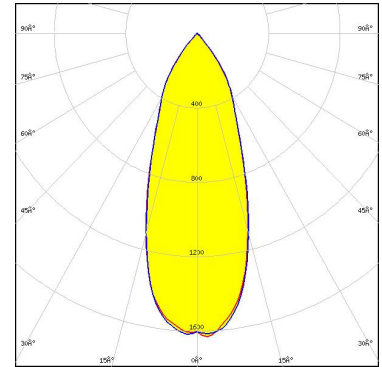

Bender Wirth: 431 Typ L3

Light distribution files



LED V22 Gen7  
 FWHM / FWTM 42.0° / 80.0°  
 Efficiency 90 %  
 Peak intensity 1.5 cd/lm  
 LEDs/each optic 1  
 Light colour/type White

Required components:  
 C13867\_LENINA-STD-BASE-VERO29

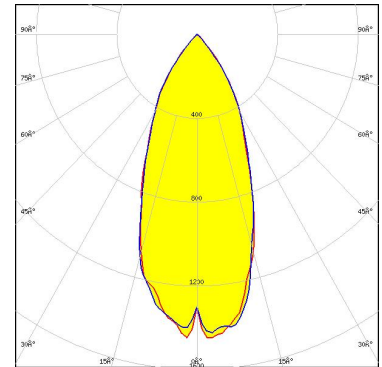

Bender Wirth: 431 Typ L3

Light distribution files



LED V22 Gen7  
 FWHM / FWTM 42.0° / 80.0°  
 Efficiency 87 %  
 Peak intensity 1.5 cd/lm  
 LEDs/each optic 1  
 Light colour/type White

Required components:  
 C13867\_LENINA-STD-BASE-VERO29  
 C12606\_LENINA-DL

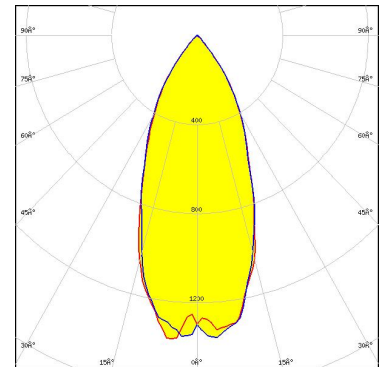

Bender Wirth: 431 Typ L3

Light distribution files

#### OPTICAL RESULTS (SIMULATED):

### CITIZEN

LED CLL03x/CLU03x  
 FWHM / FWTM 28.0° / 70.0°  
 Efficiency 91 %  
 Peak intensity 2.5 cd/lm  
 LEDs/each optic 1  
 Light colour/type White  
 Required components:  
 C12691\_LENINA-STD-BASE-CLL030

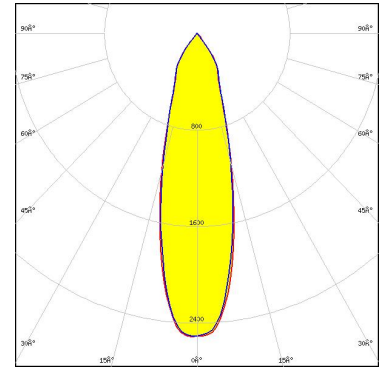

Light distribution files



LED CXA/B 15xx  
 FWHM / FWTM 16.0° / 46.0°  
 Efficiency 88 %  
 Peak intensity 4.6 cd/lm  
 LEDs/each optic 1  
 Light colour/type White  
 Required components:  
 C13186\_LENINA-STD-BASE-CXA15

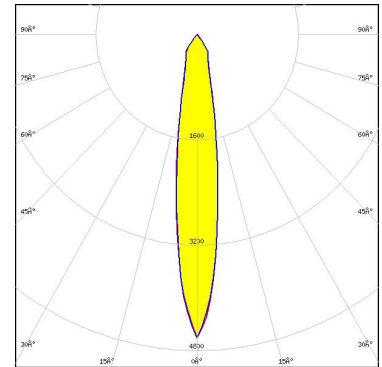

Light distribution files



LED CXA/B 1830  
 FWHM / FWTM 30.0° / 72.0°  
 Efficiency 89 %  
 Peak intensity 2.4 cd/lm  
 LEDs/each optic 1  
 Light colour/type White  
 Required components:

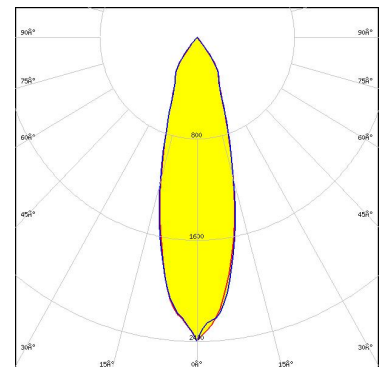

Bender Wirth: 637b Lena

Light distribution files

### OPTICAL RESULTS (SIMULATED):



LED CXA/B 30xx  
FWHM / FWTM 28.0° / 70.0°  
Efficiency 89 %  
Peak intensity 2.4 cd/lm  
LEDs/each optic 1  
Light colour/type White  
Required components:

IDEAL: 50-2234C + 50-2100LN

Light distribution files

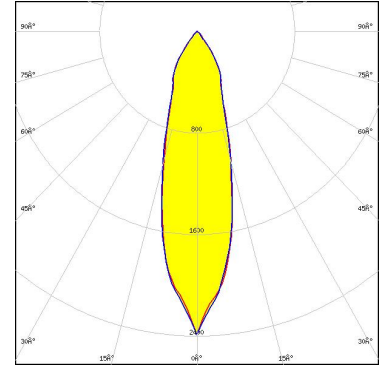

LED CXA/B 30xx  
FWHM / FWTM 30.0° / 72.0°  
Efficiency 84 %  
Peak intensity 2 cd/lm  
LEDs/each optic 1  
Light colour/type White  
Required components:

C12606\_LENINA-DL

IDEAL: 50-2234C + 50-2100LN

Light distribution files

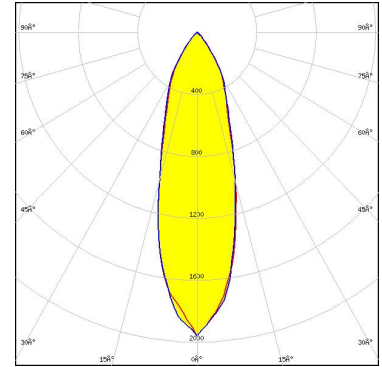

LED CxM-14 (19x19)  
FWHM / FWTM 29.0° / 73.0°  
Efficiency 91 %  
Peak intensity 2.3 cd/lm  
LEDs/each optic 1  
Light colour/type White  
Required components:

C13868\_LENA-STD-BASE-VERO13-18

Bender Wirth: 433 Typ L1

Light distribution files

### OPTICAL RESULTS (SIMULATED):



LED CxM-14 (19x19)  
FWHM / FWTM 31.0° / 73.0°  
Efficiency 88 %  
Peak intensity 2 cd/lm  
LEDs/each optic 1  
Light colour/type White

Required components:

C13868\_LENA-STD-BASE-VERO13-18  
C12606\_LENINA-DL

[Light distribution files](#)

Bender Wirth: 433 Typ L1



LED CxM-9 (13.5x13.5)  
FWHM / FWTM 23.0° / 71.0°  
Efficiency 91 %  
Peak intensity 3 cd/lm  
LEDs/each optic 1  
Light colour/type White

Required components:

C13868\_LENA-STD-BASE-VERO13-18

[Light distribution files](#)

Bender Wirth: 434 Typ L1



LED CxM-9 (13.5x13.5)  
FWHM / FWTM 26.0° / 71.0°  
Efficiency 87 %  
Peak intensity 2.3 cd/lm  
LEDs/each optic 1  
Light colour/type White

Required components:

C13868\_LENA-STD-BASE-VERO13-18  
C12606\_LENINA-DL

[Light distribution files](#)

Bender Wirth: 434 Typ L1

### OPTICAL RESULTS (SIMULATED):

**OSRAM**  
Opto Semiconductors

LED Soleriq S15  
FWHM / FWTM 30.0° / 71.0°  
Efficiency 90 %  
Peak intensity 2.4 cd/lm  
LEDs/each optic 1  
Light colour/type White

Required components:

C12691\_LENINA-STD-BASE-CLL030

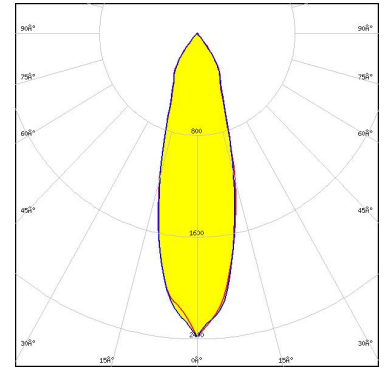

Light distribution files

**SAMSUNG**

LED LC003D / LC006D / LC009D / LC013D  
FWHM / FWTM 18.0° / 53.0°  
Efficiency 88 %  
Peak intensity 4 cd/lm  
LEDs/each optic 1  
Light colour/type White

Required components:

C12692\_LENINA-STD-BASE-CLL040

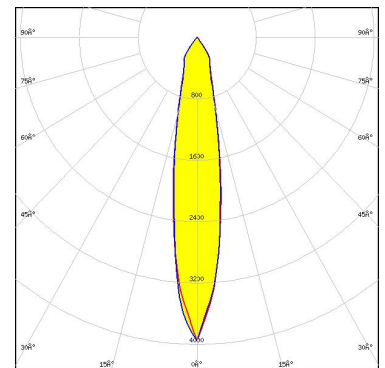

Light distribution files

**SAMSUNG**

LED LC016D / LC019D / LC026D / LC033D  
FWHM / FWTM 32.0° / 72.0°  
Efficiency 87 %  
Peak intensity 2.2 cd/lm  
LEDs/each optic 1  
Light colour/type White

Required components:

Bender Wirth: 633c Lena

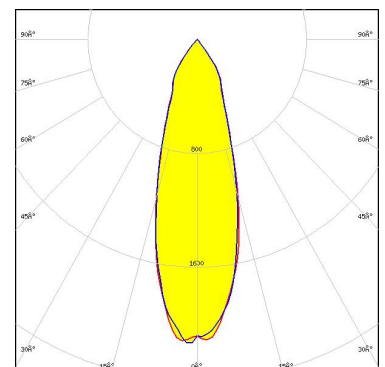

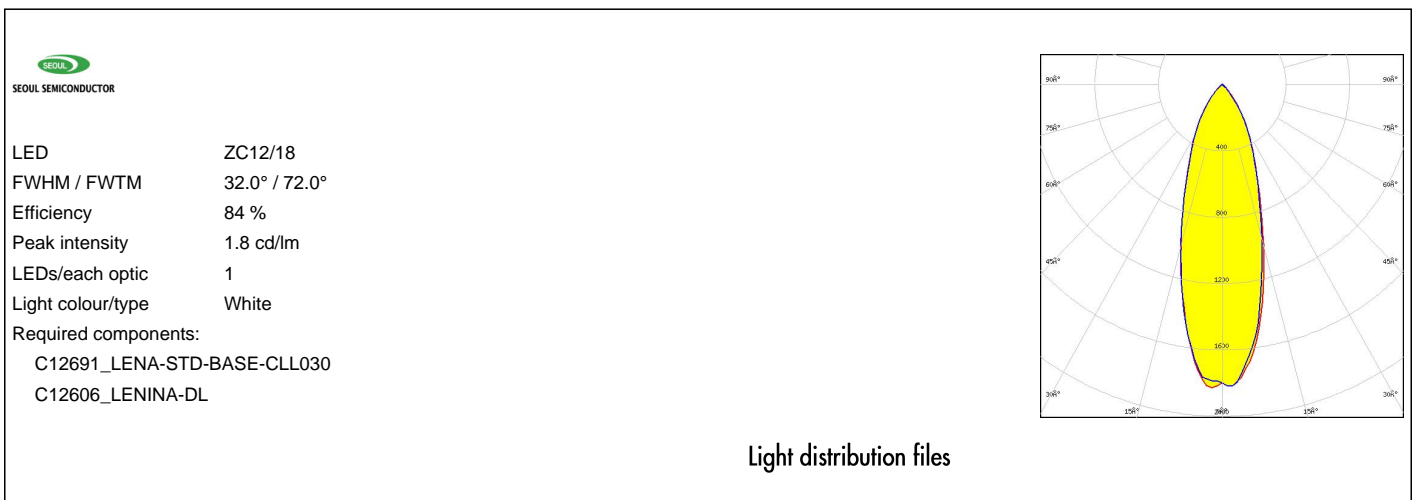
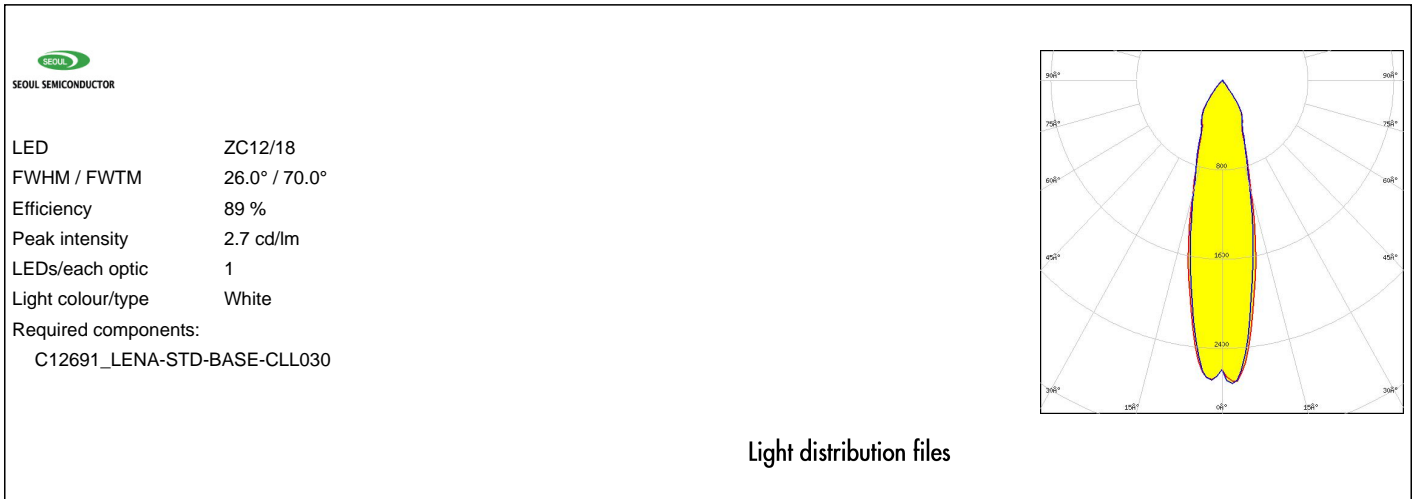

Light distribution files

### OPTICAL RESULTS (SIMULATED):



### OPTICAL RESULTS (SIMULATED):

 SEOL SEMICONDUCTOR	
LED	ZC12/18
FWHM / FWTM	31.0° / 73.0°
Efficiency	88 %
Peak intensity	2 cd/lm
LEDs/each optic	1
Light colour/type	White
Required components:	
C13868_LENINA-STD-BASE-VERO13-18	
C12606_LENINA-DL	
Bender Wirth: 433 Typ L1	

 SEOL SEMICONDUCTOR	
LED	ZC4/6
FWHM / FWTM	23.0° / 71.0°
Efficiency	91 %
Peak intensity	3 cd/lm
LEDs/each optic	1
Light colour/type	White
Required components:	
C13868_LENINA-STD-BASE-VERO13-18	
Bender Wirth: 434 Typ L1	

 SEOL SEMICONDUCTOR	
LED	ZC4/6
FWHM / FWTM	26.0° / 71.0°
Efficiency	87 %
Peak intensity	2.3 cd/lm
LEDs/each optic	1
Light colour/type	White
Required components:	
C13868_LENINA-STD-BASE-VERO13-18	
C12606_LENINA-DL	
Bender Wirth: 434 Typ L1	



### GENERAL INFORMATION:

NOTE: The typical beam angle will be changed by different color, chip size and chip position tolerance. The typical total beam angle is the full angle measured where the luminous intensity is half of the peak value.

Due to use of high power COB's with this product, special attention to proper thermal design is highly recommended. LEDiL has no liability for direct, indirect or consecutive damages arising from the LEDiL products being used outside of the recommended temperature range.

### MATERIALS:

As part of our continuous research and improvement processes, and to ensure the best possible quality and availability of our products, LEDiL reserves the right to change material grades without notice.

### PRODUCT DATA USER AGREEMENT AND DISCLAIMER:

The measured data in the provided downloadable LEDiL Product Datasheets and Mechanical 2D-Drawings is rounded and provided as reference for planning. LEDiL Oy's optical specifications have been verified by conducting performance testing of the products in accordance with the company's quality system. The reported data are averaged results of multiple measurements with typical variation. LEDiL Oy reserves the right to without prior notification make changes and improvements to its products.

LEDiL Oy assumes neither warranty, nor guarantee nor any other liability of any kind for the contents and correctness of the provided data. The provided data has been generated with highest diligence but the provided data may in reality not represent the complete possible variation range of all intrinsic parameters. Therefore, in certain cases a deviation from the provided data could occur.

LEDiL Oy reserves the right to undertake technical changes of its products without further notification which could lead to changes in the provided data. LEDiL Oy assumes no liability of any kind for the possible deviation from any provided data or any other damage resulting from the usage of the provided data.

The user agrees to this disclaimer and user agreement with the download or usage of the provided files.

#### LEDiL Oy

Joensuunkatu 7  
FI-24240 SALO  
Finland

#### LEDiL Inc.

228 West Page Street  
Suite D  
Sycamore IL 60178  
USA

#### Ledil Optics Technology (Shenzhen) Co., Ltd.

# 405 , Block B  
Casic Motor Building  
Shenzhen 518057  
P.R.CHINA

#### Local sales and technical support

[www.ledil.com/  
where\\_to\\_buy](http://www.ledil.com/where_to_buy)

#### Shipping locations

Poznan, Poland  
Hong Kong, China

#### Distribution Partners

[www.ledil.com/  
where\\_to\\_buy](http://www.ledil.com/where_to_buy)