

## LINNEA-O

~35° + 70° oval beam optimized for 1.0 mm metal sheet or profile. Variant made from PC.

### SPECIFICATION:

Dimensions	285.0 x 40.0
Height	10.5 mm
Fastening	pin
ROHS compliant	yes ⓘ

### MATERIALS:

Component	Type	Material	Colour	Finish	Length (mm)
LINNEA-O	Linear lens	PC	clear		

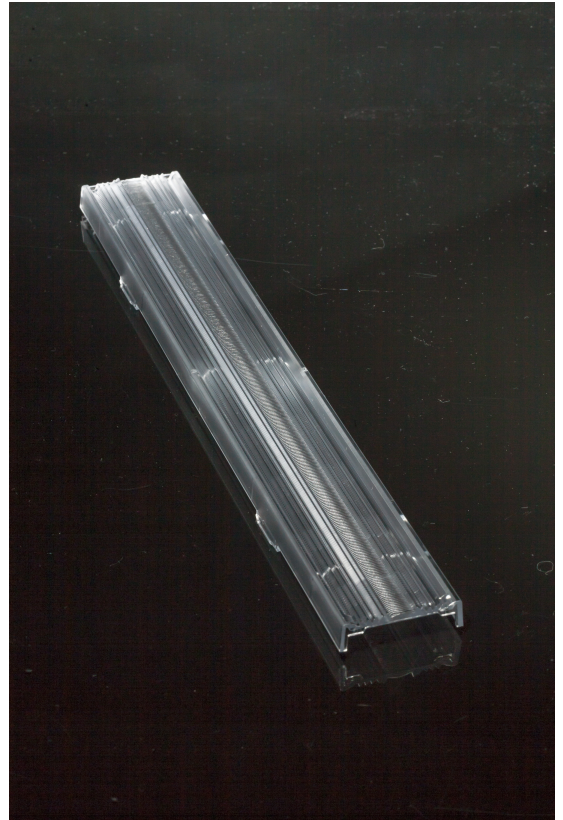

### ORDERING INFORMATION:

Component	Qty in box	MOQ	MPQ	Box weight (kg)
F15756_LINNEA-O » Box size: 398 x 298 x 265 mm	153	36	9	8.0

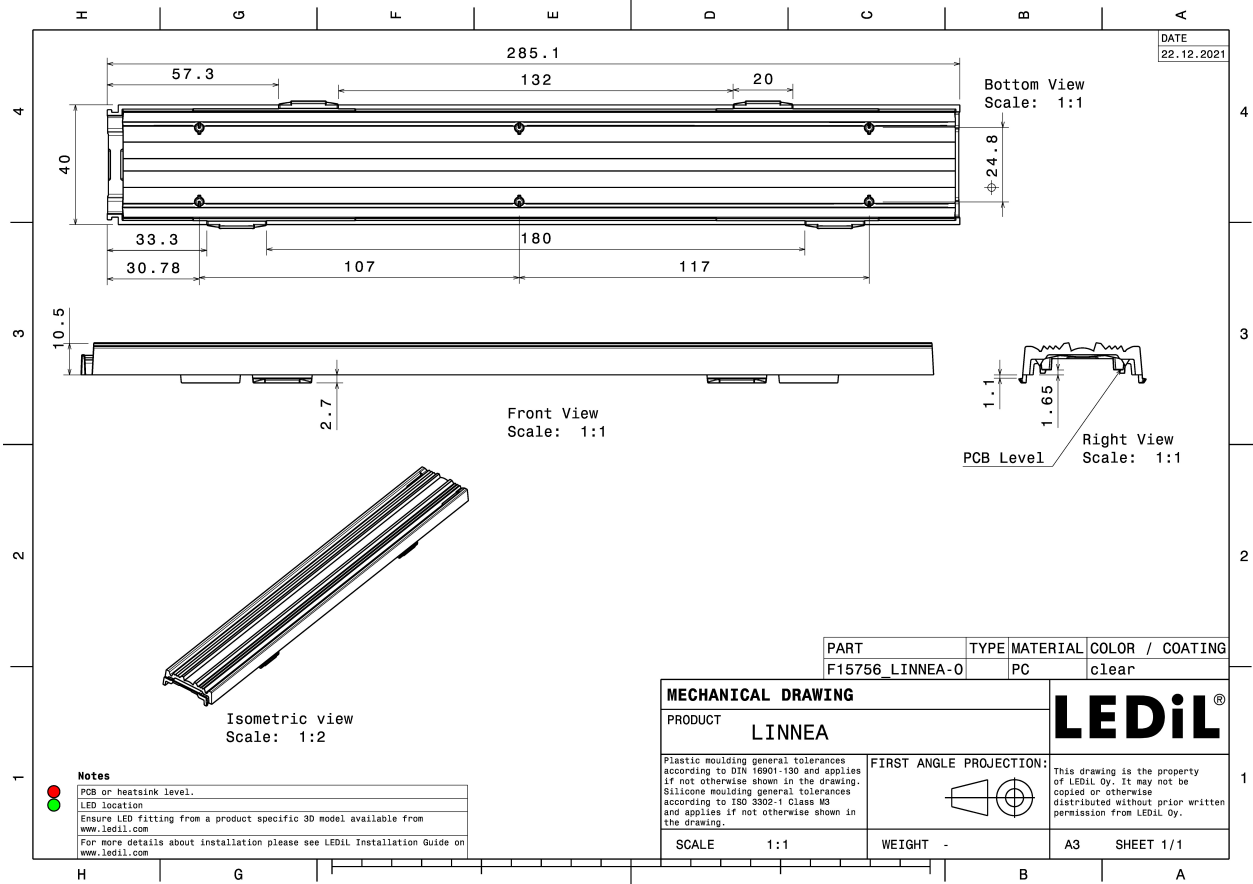

See also our general installation guide: [www.ledil.com/installation\\_guide](http://www.ledil.com/installation_guide)

### OPTICAL RESULTS (MEASURED):



LED CALOSNU405-M7W1  
 FWHM / FWTM 88.0 + 35.0° / 137.0 + 84.0°  
 Efficiency 82 %  
 Peak intensity 0.8 cd/lm  
 LEDs/each optic 1  
 Light colour/type White  
 Required components:

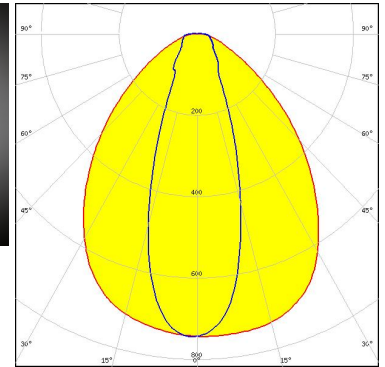
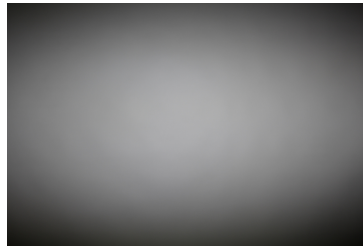

Light distribution files



LED CALOSNU410-M7W1  
 FWHM / FWTM 88.0 + 35.0° / 136.0 + 83.0°  
 Efficiency 82 %  
 Peak intensity 0.8 cd/lm  
 LEDs/each optic 1  
 Light colour/type White  
 Required components:

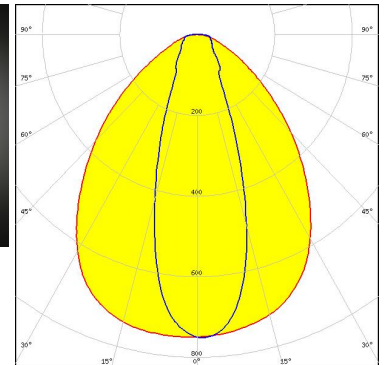
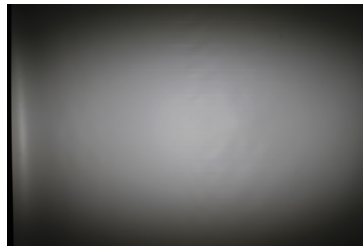

Light distribution files



LED XP-E  
 FWHM / FWTM 90.0 + 35.0° / 138.0 + 86.0°  
 Efficiency 81 %  
 Peak intensity 0.7 cd/lm  
 LEDs/each optic 1  
 Light colour/type White  
 Required components:

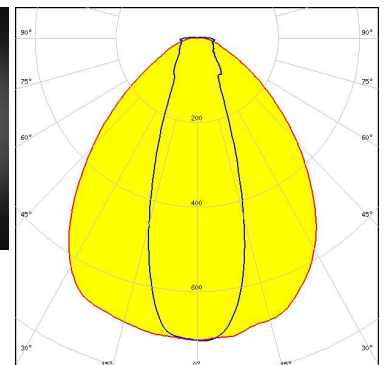
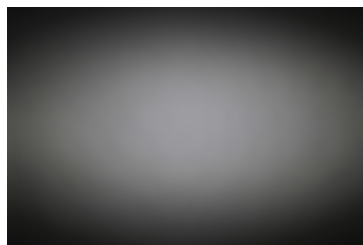

Light distribution files

### OPTICAL RESULTS (MEASURED):

#### Helvar

LED L-iC-282-827-865-011A  
 FWHM / FWTM 91.0 + 39.0° / 139.0 + 84.0°  
 Efficiency 83 %  
 Peak intensity 0.7 cd/lm  
 LEDs/each optic 1  
 Light colour/type White  
 Required components:

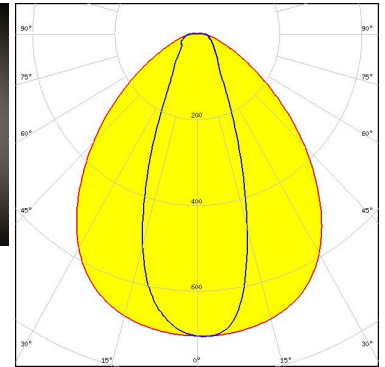
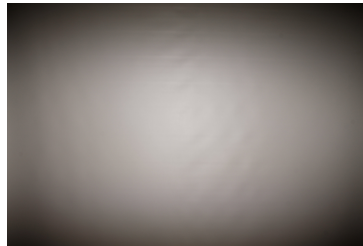

Light distribution files

#### Helvar

LED LP-282-840-009A 60/300  
 FWHM / FWTM 91.0 + 39.0° / 139.0 + 85.0°  
 Efficiency 83 %  
 Peak intensity 0.7 cd/lm  
 LEDs/each optic 1  
 Light colour/type White  
 Required components:

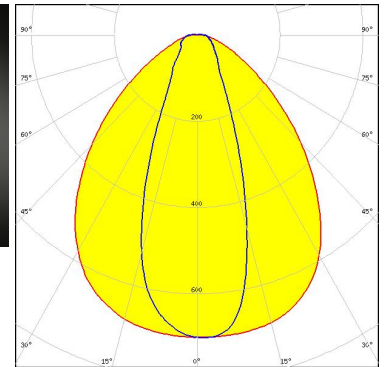
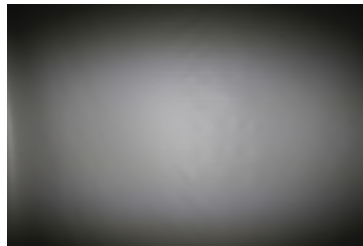

Light distribution files

#### Helvar

LED LS-282-840-011A  
 FWHM / FWTM 92.0 + 39.0° / 140.0 + 86.0°  
 Efficiency 82 %  
 Peak intensity 0.7 cd/lm  
 LEDs/each optic 1  
 Light colour/type White  
 Required components:

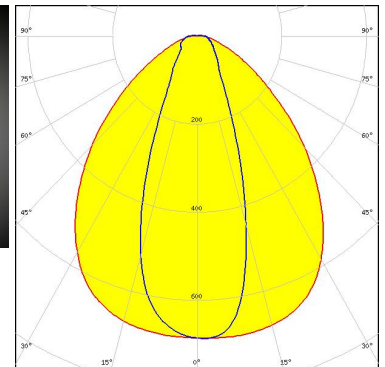
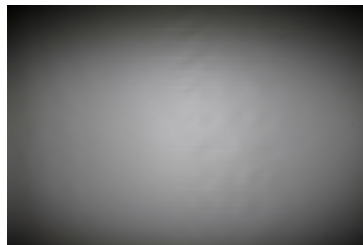

Light distribution files

### OPTICAL RESULTS (MEASURED):

#### Helvar

LED LX-282-840-023A  
 FWHM / FWTM 91.0 + 39.0° / 139.0 + 86.0°  
 Efficiency 83 %  
 Peak intensity 0.7 cd/lm  
 LEDs/each optic 1  
 Light colour/type White  
 Required components:

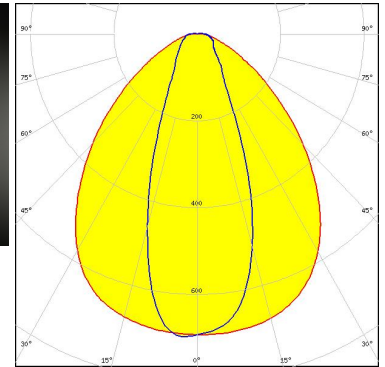
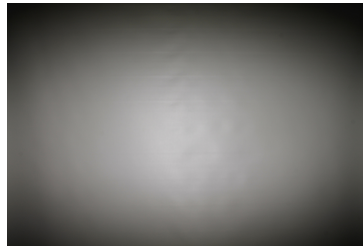

Light distribution files

#### inventronics

LED PL-LIN-IND-Z1 2800 560x24  
 FWHM / FWTM 91.0 + 39.0° / 140.0 + 94.0°  
 Efficiency 87 %  
 Peak intensity 0.7 cd/lm  
 LEDs/each optic 1  
 Light colour/type White  
 Required components:

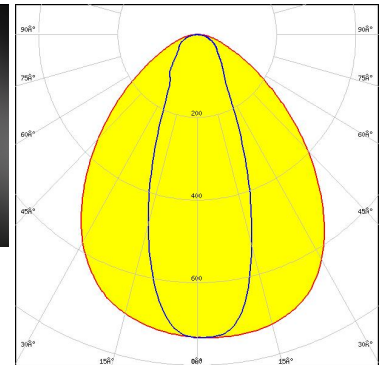
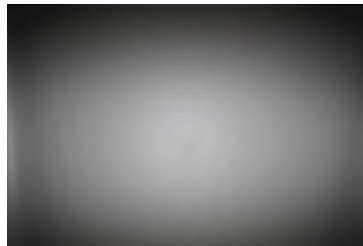

Light distribution files

#### inventronics

LED PL-LIN-Z5 1100 280x20  
 FWHM / FWTM 91.0 + 38.0° / 139.0 + 85.0°  
 Efficiency 83 %  
 Peak intensity 0.7 cd/lm  
 LEDs/each optic 1  
 Light colour/type White  
 Required components:

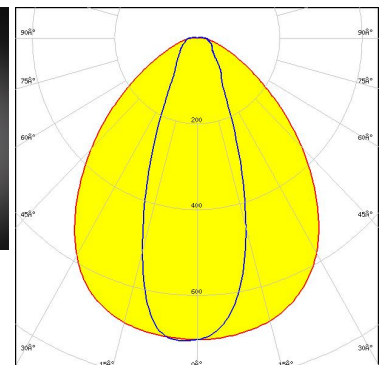
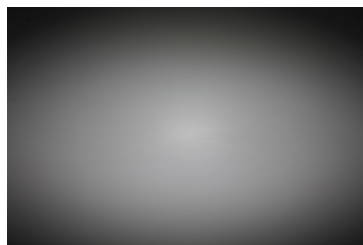

Light distribution files

### OPTICAL RESULTS (MEASURED):

**inventronics**

LED PL-LIN-Z5 2000 280x20  
 FWHM / FWTM 92.0 + 39.0° / 140.0 + 85.0°  
 Efficiency 83 %  
 Peak intensity 0.7 cd/lm  
 LEDs/each optic 1  
 Light colour/type White  
 Required components:

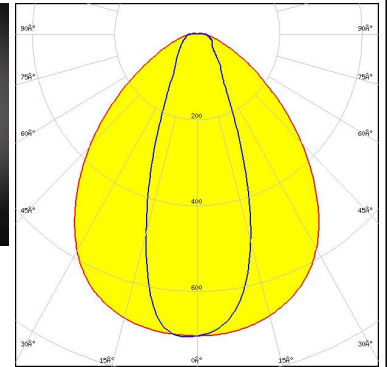

Light distribution files

**LUMITRONIX®**  
 High-Performance LED-Technologies & Solutions

LED LinearZ 280-112 Circadian TW  
 FWHM / FWTM 81.0 + 56.0° / 142.0 + 111.0°  
 Efficiency 84 %  
 Peak intensity 0.6 cd/lm  
 LEDs/each optic 1  
 Light colour/type Tunable White  
 Required components:

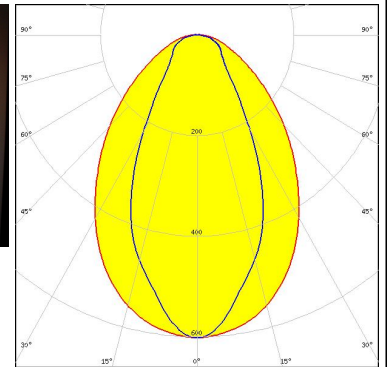
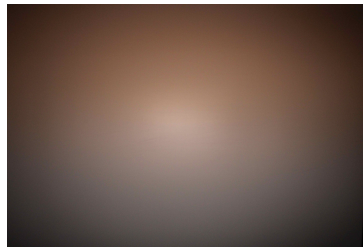

Light distribution files

**LUMITRONIX®**  
 High-Performance LED-Technologies & Solutions

LED LinearZ 280-26  
 FWHM / FWTM 89.0 + 39.0° / 140.0 + 89.0°  
 Efficiency 84 %  
 Peak intensity 0.7 cd/lm  
 LEDs/each optic 1  
 Light colour/type White  
 Required components:

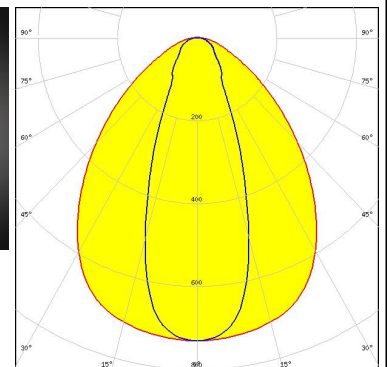
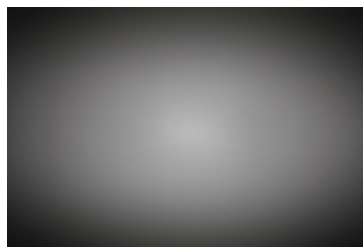

Light distribution files

### OPTICAL RESULTS (MEASURED):



**LED** LinearZ 280-40 TW  
**FWHM / FWTM** 90.0 + 38.0° / 140.0 + 89.0°  
**Efficiency** 84 %  
**Peak intensity** 0.7 cd/lm  
**LEDs/each optic** 1  
**Light colour/type** Tunable White  
**Required components:**

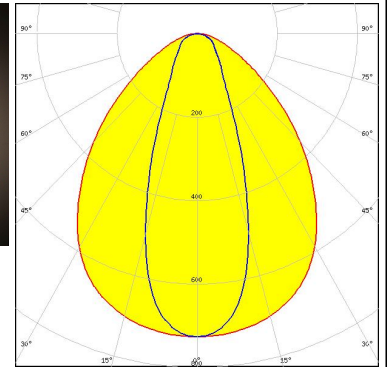
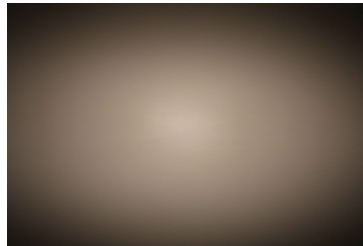

Light distribution files



**LED** LinLED 280x24mm 1100lm 830 2C 30V LINNEA-GC G1  
**FWHM / FWTM** 91.0 + 39.0° / 139.0 + 84.0°  
**Efficiency** 82 %  
**Peak intensity** 0.7 cd/lm  
**LEDs/each optic** 1  
**Light colour/type** White  
**Required components:**

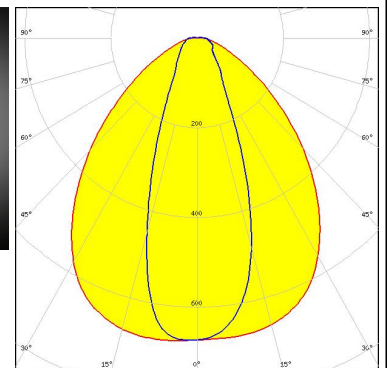
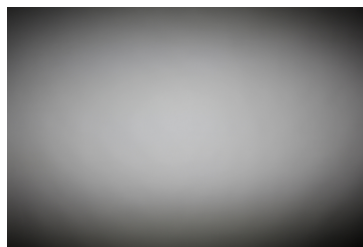

Light distribution files



**LED** NF2x757G  
**FWHM / FWTM** 86.0 + 33.0° / 136.0 + 84.0°  
**Efficiency** 82 %  
**Peak intensity** 0.8 cd/lm  
**LEDs/each optic** 1  
**Light colour/type** White  
**Required components:**

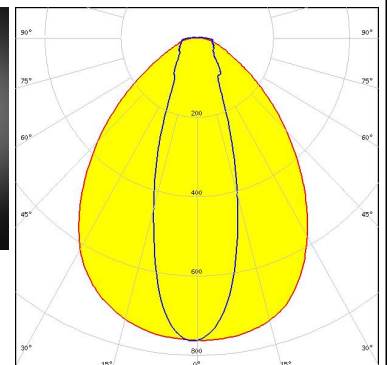
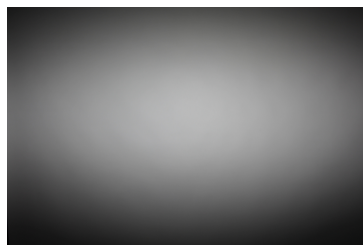

Light distribution files

### OPTICAL RESULTS (MEASURED):



LED NFSW757H  
FWHM / FWTM 92.0 + 41.0° / 140.0 + 89.0°  
Efficiency 85 %  
Peak intensity 0.7 cd/lm  
LEDs/each optic 1  
Light colour/type White  
Required components:

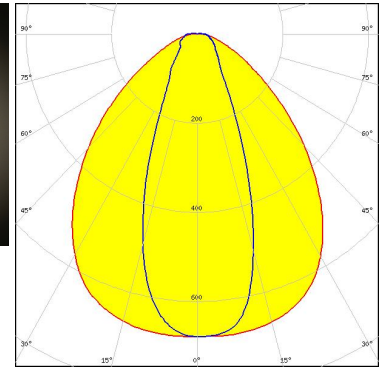

Light distribution files



LED NFSx757G  
FWHM / FWTM 87.0 + 38.0° / 140.0 + 85.0°  
Efficiency 81 %  
Peak intensity 0.7 cd/lm  
LEDs/each optic 1  
Light colour/type White  
Required components:

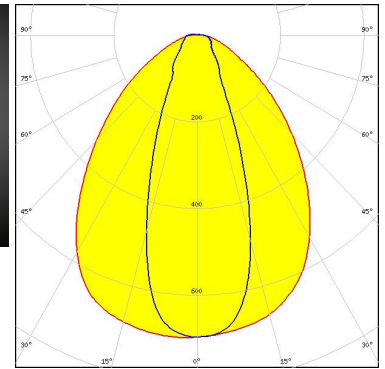

Light distribution files



LED Duris S5 (2 chip)  
FWHM / FWTM 90.0 + 38.0° / 138.0 + 86.0°  
Efficiency 83 %  
Peak intensity 0.7 cd/lm  
LEDs/each optic 1  
Light colour/type White  
Required components:

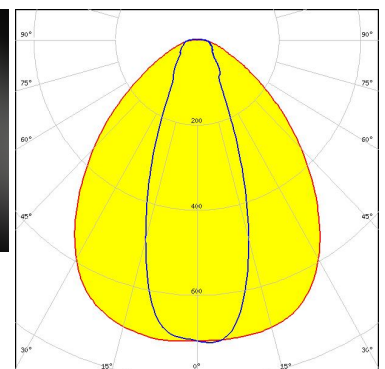
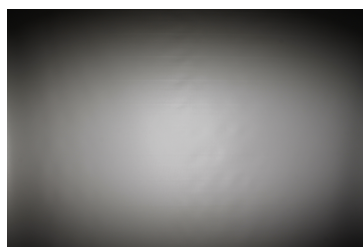

Light distribution files



#### OPTICAL RESULTS (MEASURED):

**OSRAM**  
Opto Semiconductors

LED Duris S5 (Single chip)  
 FWHM / FWTM 91.0 + 38.0° / 139.0 + 88.0°  
 Efficiency 85 %  
 Peak intensity 0.7 cd/lm  
 LEDs/each optic 1  
 Light colour/type White  
 Required components:

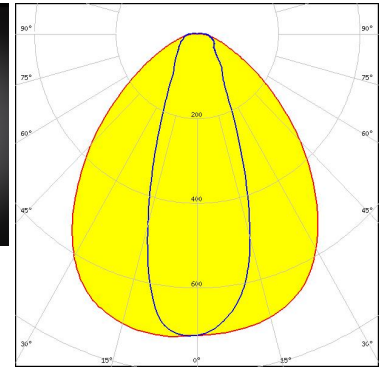
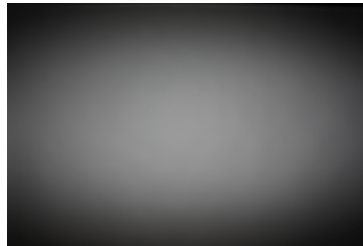

Light distribution files

**PHILIPS**

LED Fortimo LED Strip 1ft 1100lm FC HV4 & LV4  
 FWHM / FWTM 92.0 + 40.0° / 140.0 + 85.0°  
 Efficiency 83 %  
 Peak intensity 0.7 cd/lm  
 LEDs/each optic 1  
 Light colour/type White  
 Required components:

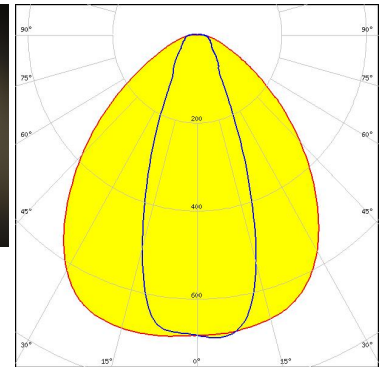
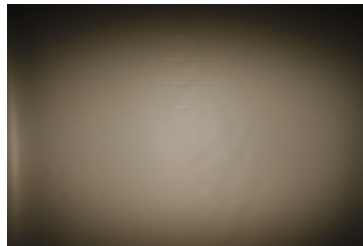

Light distribution files

**PHILIPS**

LED Fortimo LED Strip 1ft 1100lm FC HV5 & LV5  
 FWHM / FWTM 89.0 + 38.0° / 140.0 + 92.0°  
 Efficiency 86 %  
 Peak intensity 0.7 cd/lm  
 LEDs/each optic 1  
 Light colour/type White  
 Required components:

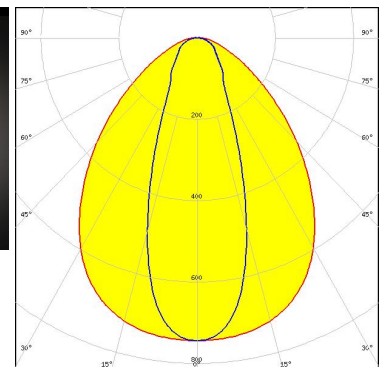
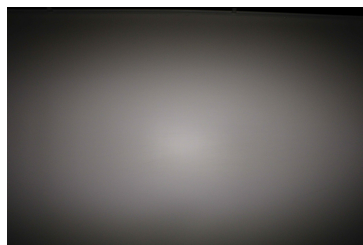

Light distribution files

### OPTICAL RESULTS (MEASURED):

#### PHILIPS

LED Fortimo LED Strip 1ft 650lm FC HV4 & LV4  
 FWHM / FWTM 93.0 + 40.0° / 140.0 + 85.0°  
 Efficiency 83 %  
 Peak intensity 0.7 cd/lm  
 LEDs/each optic 1  
 Light colour/type White  
 Required components:

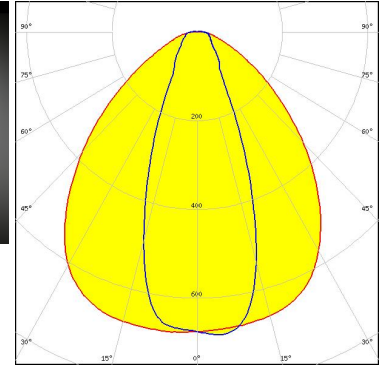
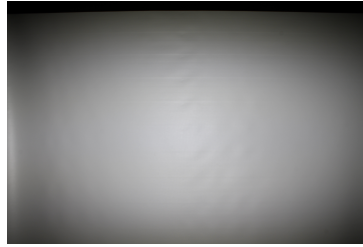

Light distribution files

#### PHILIPS

LED Fortimo LED Strip 1ft 650lm FC HV5 & LV5  
 FWHM / FWTM 85.0 + 33.0° / 136.0 + 90.0°  
 Efficiency 85 %  
 Peak intensity 0.8 cd/lm  
 LEDs/each optic 1  
 Light colour/type White  
 Required components:

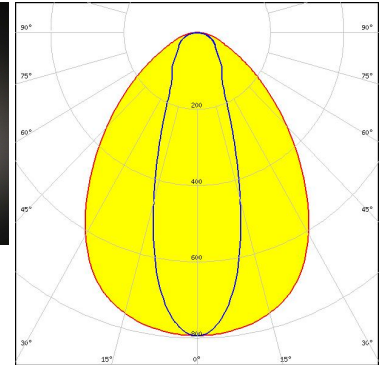

Light distribution files

#### SAMSUNG

LED LM28xB Series  
 FWHM / FWTM 88.0 + 33.0° / 137.0 + 84.0°  
 Efficiency 83 %  
 Peak intensity 0.5 cd/lm  
 LEDs/each optic 1  
 Light colour/type White  
 Required components:

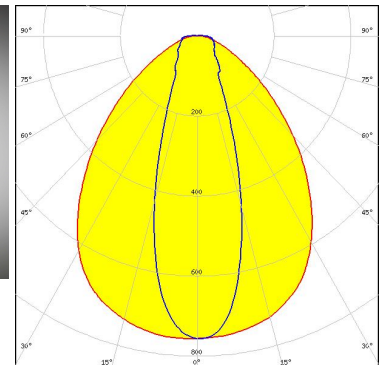
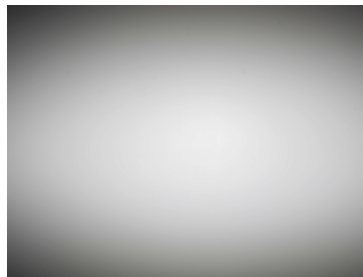

Light distribution files

### OPTICAL RESULTS (MEASURED):

#### SAMSUNG

LED LM561B Plus  
FWHM / FWTM 91.0 + 39.0° / 139.0 + 84.0°  
Efficiency 82 %  
Peak intensity 0.7 cd/lm  
LEDs/each optic 1  
Light colour/type White  
Required components:

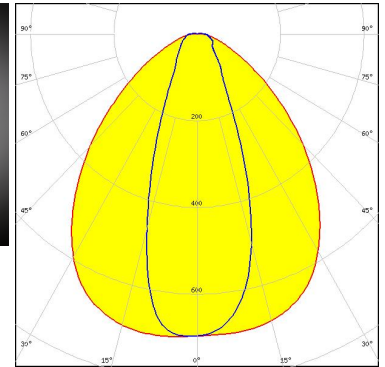
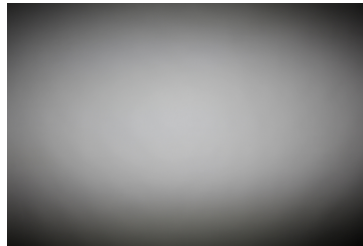

Light distribution files

#### SAMSUNG

LED LT-H282C  
FWHM / FWTM 88.0 + 33.0° / 136.0 + 84.0°  
Efficiency 83 %  
Peak intensity 0.8 cd/lm  
LEDs/each optic 1  
Light colour/type White  
Required components:

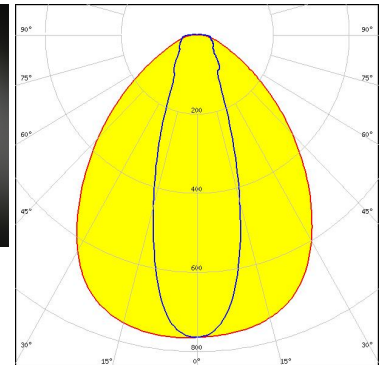
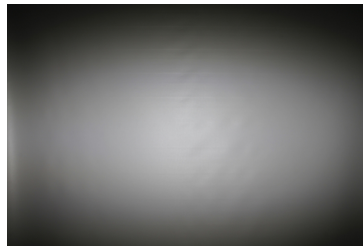

Light distribution files

#### SAMSUNG

LED LT-H562C  
FWHM / FWTM 88.0 + 33.0° / 136.0 + 84.0°  
Efficiency 83 %  
Peak intensity 0.8 cd/lm  
LEDs/each optic 1  
Light colour/type White  
Required components:

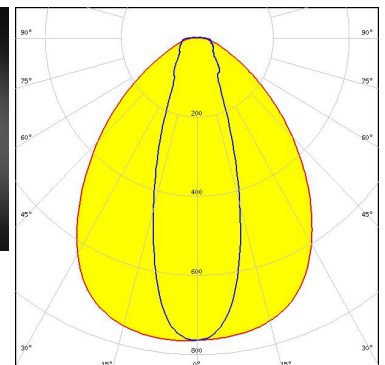
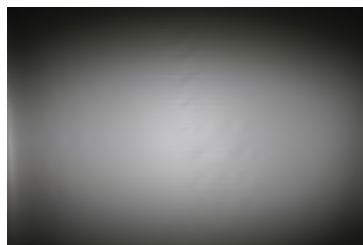

Light distribution files

### OPTICAL RESULTS (MEASURED):

#### SAMSUNG

LED LT-Q282B  
FWHM / FWTM 86.0 + 33.0° / 136.0 + 84.0°  
Efficiency 83 %  
Peak intensity 0.8 cd/lm  
LEDs/each optic 1  
Light colour/type White  
Required components:

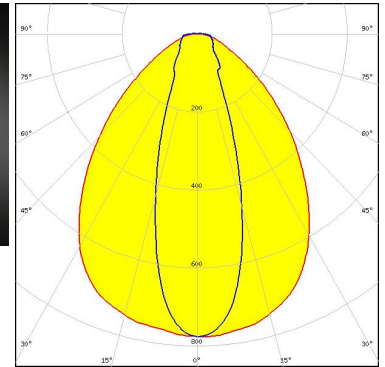
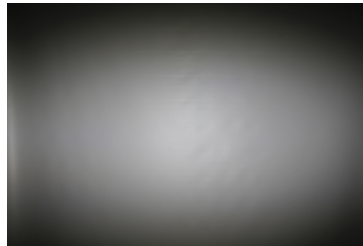

Light distribution files

#### SAMSUNG

LED LT-S282H  
FWHM / FWTM 87.0 + 33.0° / 136.0 + 84.0°  
Efficiency 83 %  
Peak intensity 0.8 cd/lm  
LEDs/each optic 1  
Light colour/type White  
Required components:

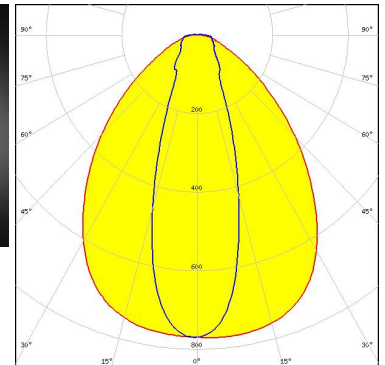
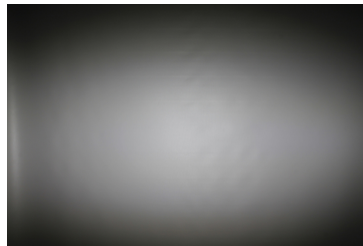

Light distribution files

#### SAMSUNG

LED LT-S562H  
FWHM / FWTM 87.0 + 33.0° / 136.0 + 84.0°  
Efficiency 83 %  
Peak intensity 0.8 cd/lm  
LEDs/each optic 1  
Light colour/type White  
Required components:

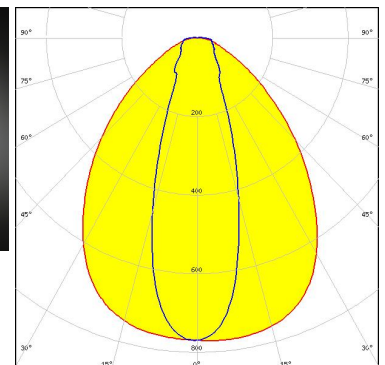
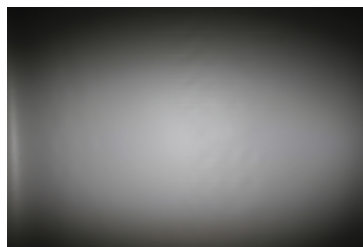

Light distribution files

### OPTICAL RESULTS (MEASURED):

#### SAMSUNG

LED LT-V282E  
 FWHM / FWTM 87.0 + 33.0° / 136.0 + 84.0°  
 Efficiency 83 %  
 Peak intensity 0.8 cd/lm  
 LEDs/each optic 1  
 Light colour/type White  
 Required components:

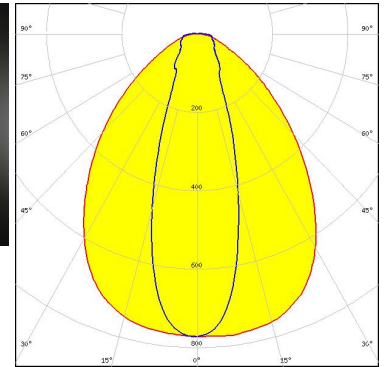
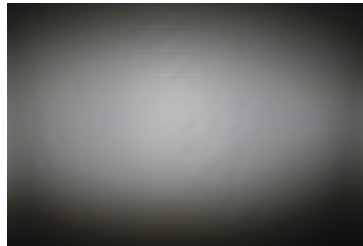

Light distribution files

#### SAMSUNG

LED LT-V562E  
 FWHM / FWTM 87.0 + 33.0° / 136.0 + 84.0°  
 Efficiency 83 %  
 Peak intensity 0.8 cd/lm  
 LEDs/each optic 1  
 Light colour/type White  
 Required components:

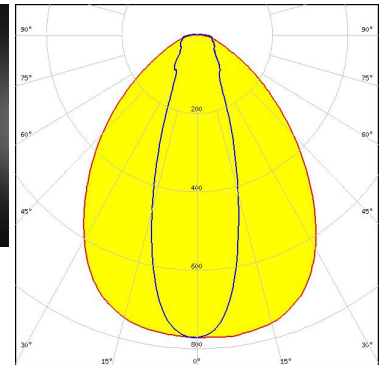
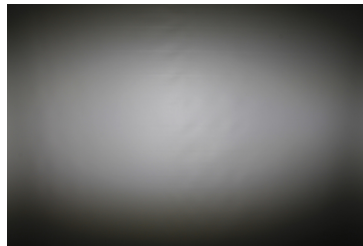

Light distribution files





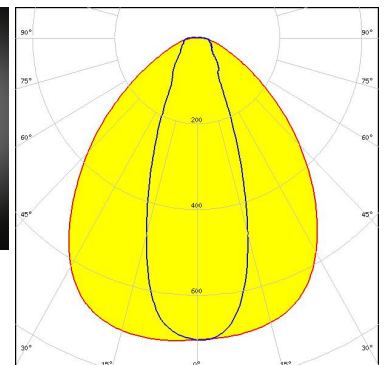
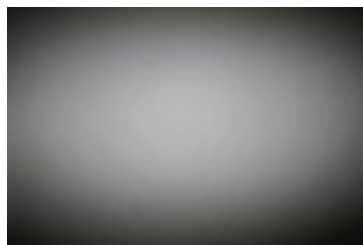

LED SEOUL 5630D  
 FWHM / FWTM 91.0 + 38.0° / 139.0 + 86.0°  
 Efficiency 82 %  
 Peak intensity 0.7 cd/lm  
 LEDs/each optic 1  
 Light colour/type White  
 Required components:

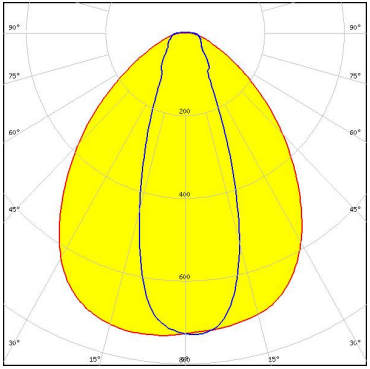

Light distribution files

### OPTICAL RESULTS (MEASURED):

			
LED	SEOUL DC 3030		
FWHM / FWTM	89.0 + 37.0° / 138.0 + 87.0°		
Efficiency	84 %		
Peak intensity	0.7 cd/lm		
LEDs/each optic	1		
Light colour/type	White		
Required components:		Light distribution files	

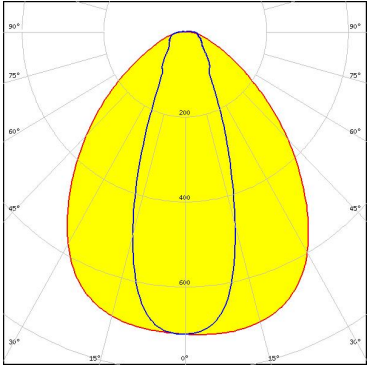
<h2>TRIDONIC</h2>			
LED	LLE G4 24x280mm 1250lm		
FWHM / FWTM	89.0 + 38.0° / 138.0 + 86.0°		
Efficiency	83 %		
Peak intensity	0.7 cd/lm		
LEDs/each optic	1		
Light colour/type	White		
Required components:		Light distribution files	

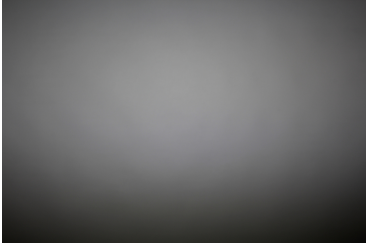
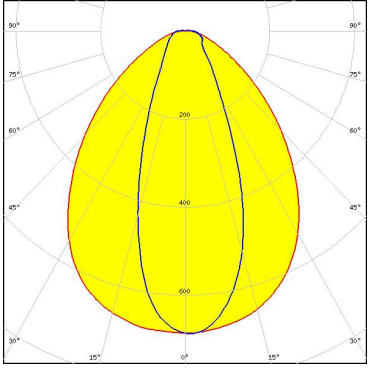
<h2>TRIDONIC</h2>			
LED	LLE G4 24x280mm 2000lm ADV		
FWHM / FWTM	88.0 + 40.0° / 139.0 + 88.0°		
Efficiency	83 %		
Peak intensity	0.7 cd/lm		
LEDs/each optic	1		
Light colour/type	White		
Required components:		Light distribution files	

### OPTICAL RESULTS (MEASURED):

#### TRIDONIC

LED LLE G4 24x280mm 650lm  
FWHM / FWTM 90.0 + 39.0° / 138.0 + 87.0°  
Efficiency 84 %  
Peak intensity 0.7 cd/lm  
LEDs/each optic 1  
Light colour/type White  
Required components:

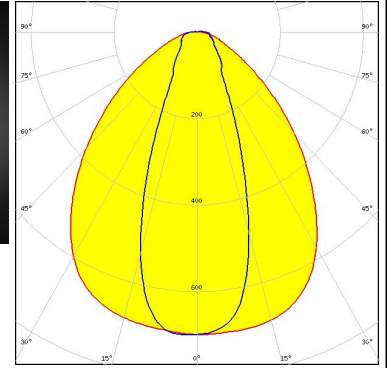
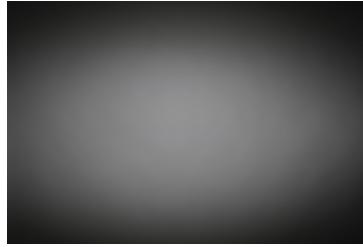

Light distribution files

### OPTICAL RESULTS (SIMULATED):



LED Bridgelux SMD 2835  
FWHM / FWTM 82.0 + 33.0° / 125.0 + 52.0°  
Efficiency 79 %  
Peak intensity 0.9 cd/lm  
LEDs/each optic 1  
Light colour/type White  
Required components:

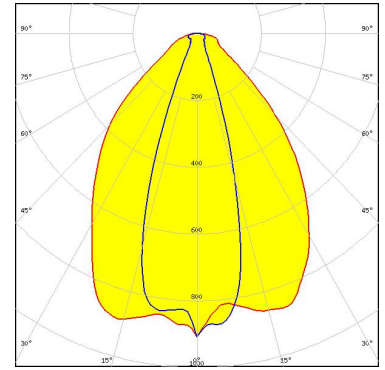

Light distribution files



LED NF2x757G  
FWHM / FWTM 34.0 + 75.0° / 60.0 + 128.0°  
Efficiency 83 %  
Peak intensity 0.9 cd/lm  
LEDs/each optic 1  
Light colour/type White  
Required components:

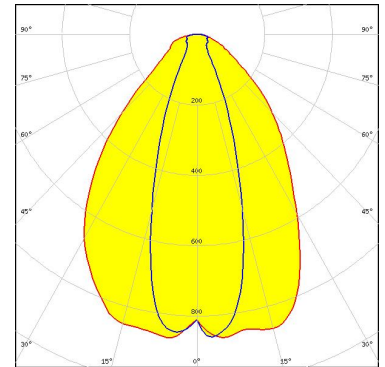

Light distribution files



LED NF2x757G  
FWHM / FWTM 81.0 + 34.0° / 125.0 + 52.0°  
Efficiency 78 %  
Peak intensity 0.9 cd/lm  
LEDs/each optic 1  
Light colour/type White  
Required components:

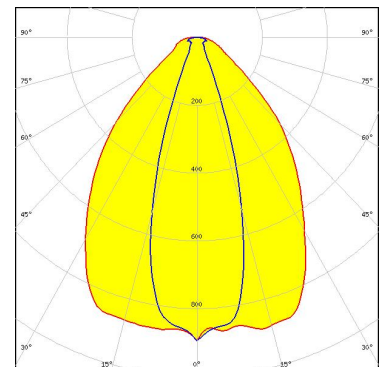

Light distribution files



### OPTICAL RESULTS (SIMULATED):

 SEOUL SEMICONDUCTOR		
LED	SEOUL DC 3030C	
FWHM / FWTM	82.0 + 34.0° / 134.0 + 60.0°	
Efficiency	84 %	
Peak intensity	0.9 cd/lm	
LEDs/each optic	1	
Light colour/type	White	
Required components:		

Light distribution files

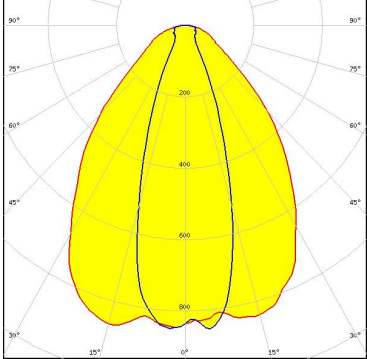

### GENERAL INFORMATION:

NOTE: The typical beam angle will be changed by different color, chip size and chip position tolerance. The typical total beam angle is the full angle measured where the luminous intensity is half of the peak value.

### MATERIALS:

As part of our continuous research and improvement processes, and to ensure the best possible quality and availability of our products, LEDiL reserves the right to change material grades without notice.

### PRODUCT DATA USER AGREEMENT AND DISCLAIMER:

The measured data in the provided downloadable LEDiL Product Datasheets and Mechanical 2D-Drawings is rounded and provided as reference for planning. LEDiL Oy's optical specifications have been verified by conducting performance testing of the products in accordance with the company's quality system. The reported data are averaged results of multiple measurements with typical variation. LEDiL Oy reserves the right to without prior notification make changes and improvements to its products.

LEDiL Oy assumes neither warranty, nor guarantee nor any other liability of any kind for the contents and correctness of the provided data. The provided data has been generated with highest diligence but the provided data may in reality not represent the complete possible variation range of all intrinsic parameters. Therefore, in certain cases a deviation from the provided data could occur.

LEDiL Oy reserves the right to undertake technical changes of its products without further notification which could lead to changes in the provided data. LEDiL Oy assumes no liability of any kind for the possible deviation from any provided data or any other damage resulting from the usage of the provided data.

The user agrees to this disclaimer and user agreement with the download or usage of the provided files.

#### LEDiL Oy

Joensuunkatu 7  
FI-24240 SALO  
Finland

#### LEDiL Inc.

228 West Page Street  
Suite D  
Sycamore IL 60178  
USA

#### Ledil Optics Technology (Shenzhen) Co., Ltd.

# 405 , Block B  
Casic Motor Building  
Shenzhen 518057  
P.R.CHINA

#### Local sales and technical support

[www.ledil.com/  
where\\_to\\_buy](http://www.ledil.com/where_to_buy)

#### Shipping locations

Poznan, Poland  
Hong Kong, China

#### Distribution Partners

[www.ledil.com/  
where\\_to\\_buy](http://www.ledil.com/where_to_buy)