

## LISA2-W-CLIP

~35° wide beam optimized for CREE XP-E. 6.8 mm high variant with clip installation.

### SPECIFICATION:

Dimensions	Ø 9.9
Height	6.8 mm
Fastening	glue, clips
ROHS compliant	yes ⓘ



### MATERIALS:

Component	Type	Material	Colour	Finish	Length (mm)
LISA2-W	Single lens	PMMA	clear		
LISA2-HLD-CLIP16-XP	Holder	PC	black		

### ORDERING INFORMATION:

Component		Qty in box	MOQ	MPQ	Box weight (kg)
FP11076_LISA2-W-CLIP	Single lens	2000	300	100	1.4
» Box size:					

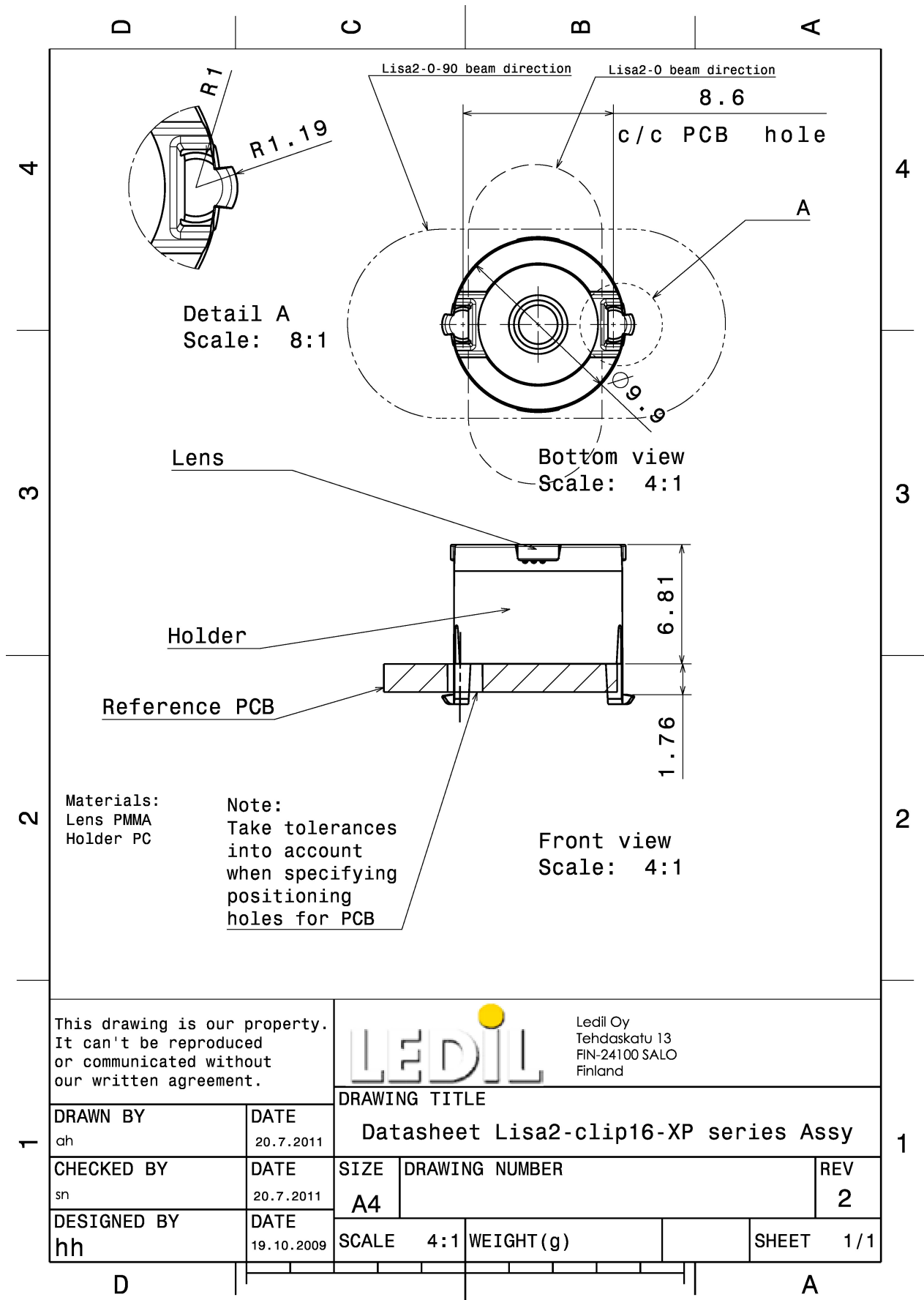

This drawing is our property. It can't be reproduced or communicated without our written agreement.		<b>LEDiL</b>		Ledil Oy Tehdaskatu 13 FIN-24100 SALO Finland	
DRAWN BY ch		DATE 20.7.2011		DRAWING TITLE Datasheet Lisa2-clip16-XP series Assy	
CHECKED BY sn		DATE 20.7.2011		SIZE A4	DRAWING NUMBER
DESIGNED BY hh		DATE 19.10.2009		SCALE 4:1	WEIGHT (g)
				SHEET	1/1

See also our general installation guide: [www.ledil.com/installation\\_guide](http://www.ledil.com/installation_guide)

### OPTICAL RESULTS (MEASURED):



LED XP-E  
FWHM / FWTM 37.0°  
Efficiency 90 %  
Peak intensity 2 cd/m  
LEDs/each optic 1  
Light colour/type White  
Required components:

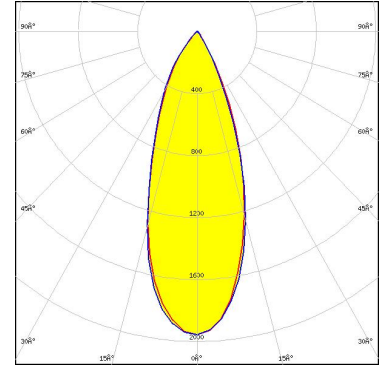

Light distribution files



LED XP-G  
FWHM / FWTM 48.0°  
Efficiency 93 %  
LEDs/each optic 1  
Light colour/type White  
Required components:

Light distribution files



LED LUXEON A  
FWHM / FWTM 48.0°  
Efficiency 93 %  
LEDs/each optic 1  
Light colour/type White  
Required components:

Light distribution files

#### OPTICAL RESULTS (MEASURED):



LED LUXEON Rebel ES  
FWHM / FWTM 46.0°  
Efficiency 93 %  
LEDs/each optic 1  
Light colour/type White  
Required components:

[Light distribution files](#)



LED LUXEON Z  
FWHM / FWTM 27.0° / 60.0°  
Efficiency 87 %  
Peak intensity 2.9 cd/lm  
LEDs/each optic 1  
Light colour/type White  
Required components:

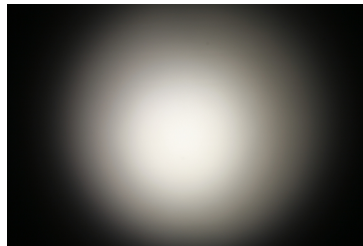

[Light distribution files](#)



LED LUXEON Z ES  
FWHM / FWTM 35.0° / 64.0°  
Efficiency 87 %  
Peak intensity 2.1 cd/lm  
LEDs/each optic 1  
Light colour/type White  
Required components:

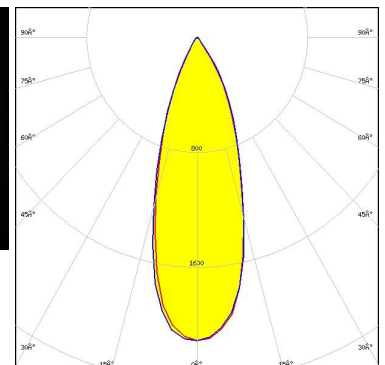
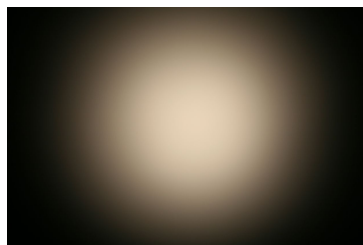

[Light distribution files](#)

### OPTICAL RESULTS (MEASURED):

**OSRAM**  
Opto Semiconductors

LED SFH 4170S  
FWHM / FWTM 26.0° / 61.0°  
Efficiency %  
LEDs/each optic 1  
Light colour/type IR  
Required components:

Light distribution files

**OSRAM**  
Opto Semiconductors

LED SFH 4180S  
FWHM / FWTM 26.0° / 61.0°  
Efficiency %  
LEDs/each optic 1  
Light colour/type IR  
Required components:

Light distribution files

**SHARP**

LED Double Dome (GM2BB)  
FWHM / FWTM 44.0°  
Efficiency %  
LEDs/each optic 1  
Light colour/type White  
Required components:

Light distribution files

### OPTICAL RESULTS (SIMULATED):



LED XQ-E HD  
FWHM / FWTM 49.0° / 80.0°  
Efficiency 90 %  
Peak intensity 1.3 cd/lm  
LEDs/each optic 1  
Light colour/type White  
Required components:

Light distribution files



LED XQ-E HI  
FWHM / FWTM 23.0° / 52.0°  
Efficiency 89 %  
Peak intensity 3.6 cd/lm  
LEDs/each optic 1  
Light colour/type White  
Required components:

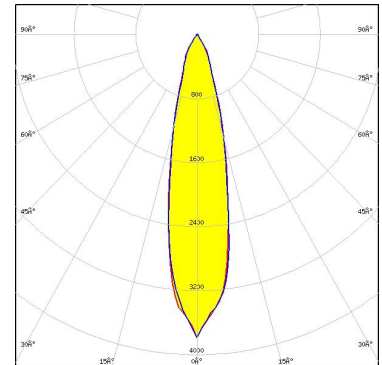

Light distribution files



LED NCSxE17A  
FWHM / FWTM 30.0° / 57.0°  
Efficiency 84 %  
Peak intensity 2.6 cd/lm  
LEDs/each optic 1  
Light colour/type White  
Required components:

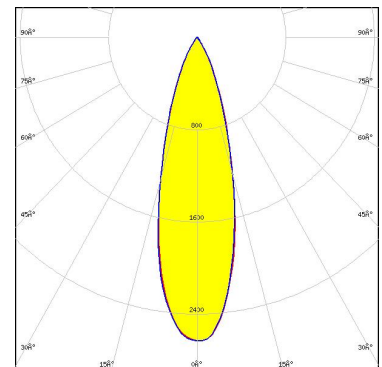

Light distribution files

#### OPTICAL RESULTS (SIMULATED):

**OSRAM**  
Opto Semiconductors

LED SFH 4770S  
FWHM / FWTM 29.0° / 60.0°  
Efficiency 92 %  
LEDs/each optic 1  
Light colour/type IR  
Required components:

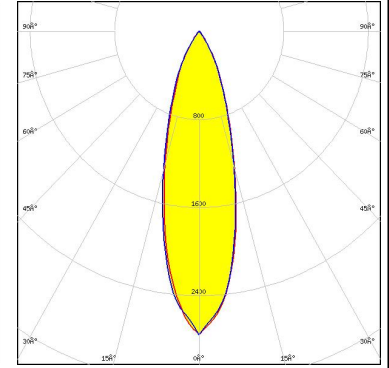
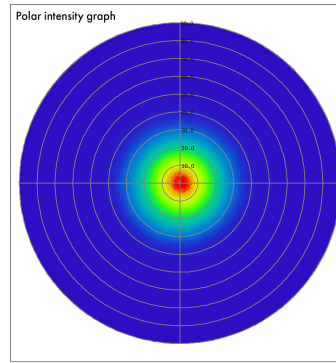

Light distribution files

### GENERAL INFORMATION:

NOTE: The typical beam angle will be changed by different color, chip size and chip position tolerance. The typical total beam angle is the full angle measured where the luminous intensity is half of the peak value.

### MATERIALS:

As part of our continuous research and improvement processes, and to ensure the best possible quality and availability of our products, LEDiL reserves the right to change material grades without notice.

### PRODUCT DATA USER AGREEMENT AND DISCLAIMER:

The measured data in the provided downloadable LEDiL Product Datasheets and Mechanical 2D-Drawings is rounded and provided as reference for planning. LEDiL Oy's optical specifications have been verified by conducting performance testing of the products in accordance with the company's quality system. The reported data are averaged results of multiple measurements with typical variation. LEDiL Oy reserves the right to without prior notification make changes and improvements to its products.

LEDiL Oy assumes neither warranty, nor guarantee nor any other liability of any kind for the contents and correctness of the provided data. The provided data has been generated with highest diligence but the provided data may in reality not represent the complete possible variation range of all intrinsic parameters. Therefore, in certain cases a deviation from the provided data could occur.

LEDiL Oy reserves the right to undertake technical changes of its products without further notification which could lead to changes in the provided data. LEDiL Oy assumes no liability of any kind for the possible deviation from any provided data or any other damage resulting from the usage of the provided data.

The user agrees to this disclaimer and user agreement with the download or usage of the provided files.

#### LEDiL Oy

Joensuunkatu 7  
FI-24240 SALO  
Finland

#### LEDiL Inc.

228 West Page Street  
Suite D  
Sycamore IL 60178  
USA

#### Ledil Optics Technology (Shenzhen) Co., Ltd.

# 405 , Block B  
Casic Motor Building  
Shenzhen 518057  
P.R.CHINA

#### Local sales and technical support

[www.ledil.com/  
where\\_to\\_buy](http://www.ledil.com/where_to_buy)

#### Shipping locations

Poznan, Poland  
Hong Kong, China

#### Distribution Partners

[www.ledil.com/  
where\\_to\\_buy](http://www.ledil.com/where_to_buy)