

LISA2-WWW-PIN

~80° wide beam. 7.0 mm high variant with location pin installation.

SPECIFICATION:

Dimensions	Ø 9.9
Height	7 mm
Fastening	glue, pin
ROHS compliant	yes ⓘ



MATERIALS:

Component	Type	Material	Colour	Finish	Length (mm)
LISA2-WWW	Single lens	PMMA	clear		
LISA2-HLD-PIN	Holder	PC	black		

ORDERING INFORMATION:

Component		Qty in box	MOQ	MPQ	Box weight (kg)
FP11429_LISA2-WWW-PIN	Single lens	2000		100	1.4
» Box size:					

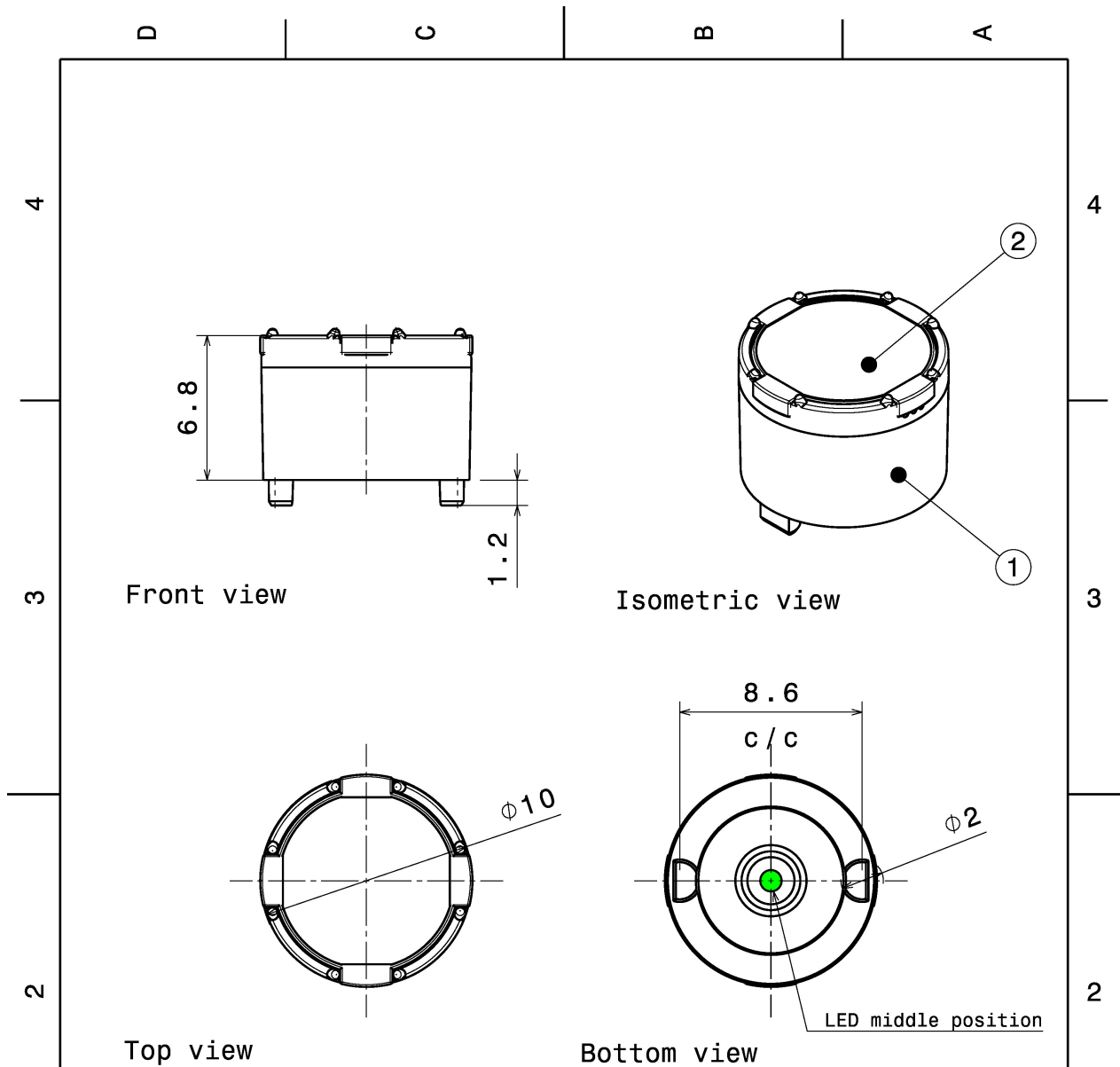

INDEX	PART NO	DESCRIPTION	MATERIAL	COLOUR
1	F10989	LISA2-HLD-PIN	PC	black
2	-	LISA2_lens	PMMA	

Tolerances if not otherwise shown
According to DIN ISO 2768-1
Linear measures:
up to 30mm class M, otherwise class C
According to DIN ISO 2768-2
Form and position: class L

LEDiL Ledil Oy
Salorankatu 10
FIN 24240 SALO
Finland

THIRD ANGLE PROJECTION:

DRAWING TITLE
Lisa2-PIN-XP assembly

This drawing is the property of LEDiL Oy. It may not be reproduced, copied or communicated without a written agreement with LEDiL Oy.

SIZE	PART NUMBER
A4	-

SCALE	4:1	WEIGHT	0,5 g	SHEET	1/1
-------	-----	--------	-------	-------	-----

See also our general installation guide: www.ledil.com/installation_guide

OPTICAL RESULTS (MEASURED):



LED XD16
 FWHM / FWTM 66.0° / 110.0°
 Efficiency 66 %
 Peak intensity 0.6 cd/lm
 LEDs/each optic 1
 Light colour/type White
 Required components:

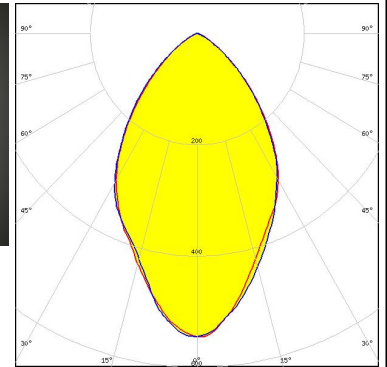
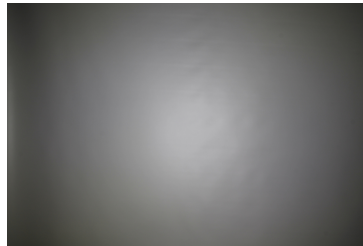

Light distribution files



LED XP-E
 FWHM / FWTM 84.0°
 Efficiency 77 %
 Peak intensity 0.5 cd/lm
 LEDs/each optic 1
 Light colour/type White
 Required components:

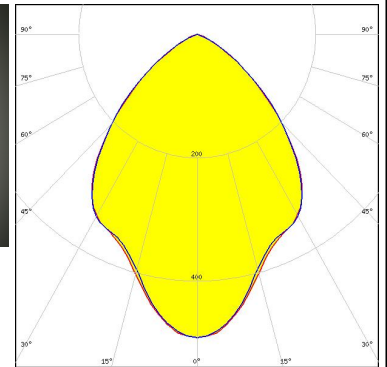
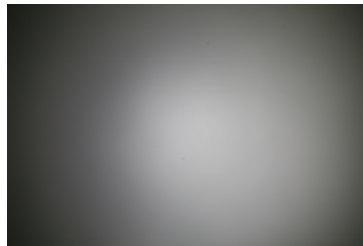

Light distribution files



LED XP-G
 FWHM / FWTM 86.0° / 126.0°
 Efficiency 75 %
 Peak intensity 0.4 cd/lm
 LEDs/each optic 1
 Light colour/type White
 Required components:

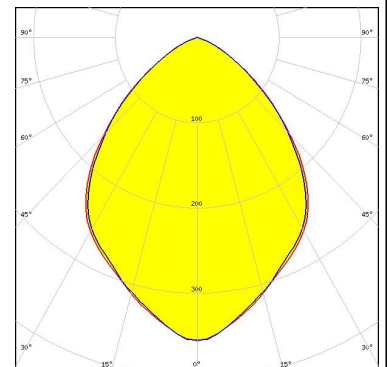

Light distribution files

OPTICAL RESULTS (MEASURED):



LED LUXEON A
FWHM / FWTM 86.0° / 122.0°
Efficiency 72 %
Peak intensity 0.3 cd/lm
LEDs/each optic 1
Light colour/type White
Required components:

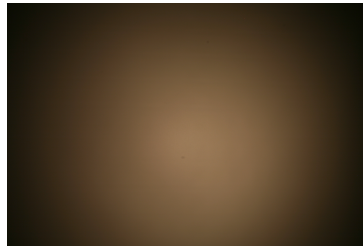

[Light distribution files](#)



LED LUXEON Rebel ES
FWHM / FWTM 88.0°
Efficiency %
LEDs/each optic 1
Light colour/type White
Required components:

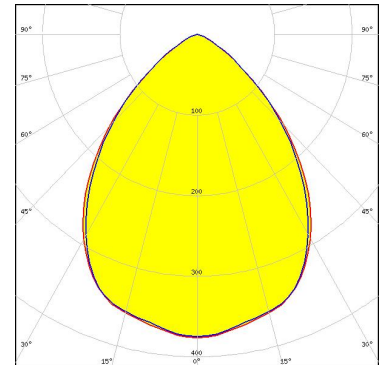

[Light distribution files](#)



LED LUXEON Z
FWHM / FWTM 73.0° / 106.0°
Efficiency 75 %
Peak intensity 0.6 cd/lm
LEDs/each optic 1
Light colour/type White
Required components:

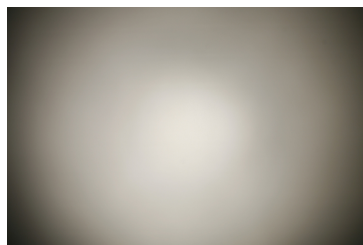

[Light distribution files](#)

OPTICAL RESULTS (MEASURED):



LED NVSxE21A
FWHM / FWTM 53.0° / 98.0°
Efficiency 70 %
Peak intensity 0.8 cd/lm
LEDs/each optic 1
Light colour/type White
Required components:

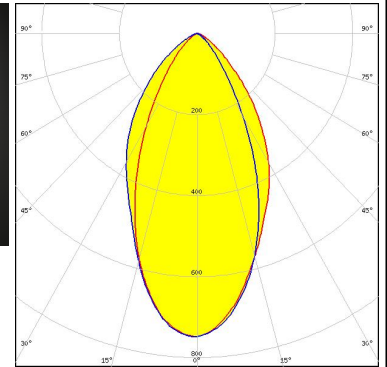
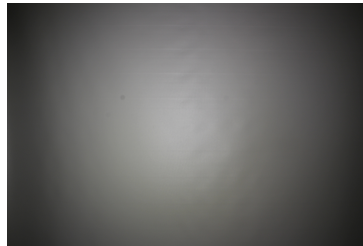

Light distribution files



LED SFH 4170S
FWHM / FWTM 58.0° / 114.0°
Efficiency %
LEDs/each optic 1
Light colour/type IR
Required components:

Light distribution files



LED SFH 4180S
FWHM / FWTM 57.0° / 112.0°
Efficiency %
LEDs/each optic 1
Light colour/type IR
Required components:

Light distribution files

OPTICAL RESULTS (MEASURED):

SAMSUNG

LED LH181B
FWHM / FWTM 62.0° / 104.0°
Efficiency 72 %
Peak intensity 0.6 cd/lm
LEDs/each optic 1
Light colour/type White
Required components:

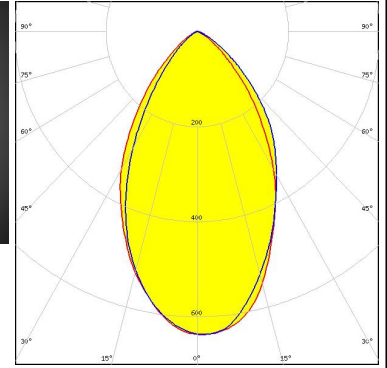
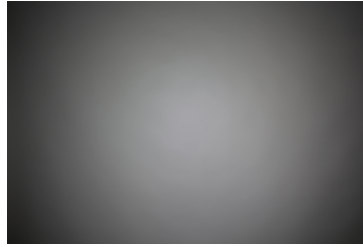

Light distribution files

OPTICAL RESULTS (SIMULATED):



LED CSP 2323 (BXCP)
FWHM / FWTM 61.0° / 111.0 + 112.0°
Efficiency 83 %
Peak intensity 0.7 cd/lm
LEDs/each optic 1
Light colour/type White
Required components:

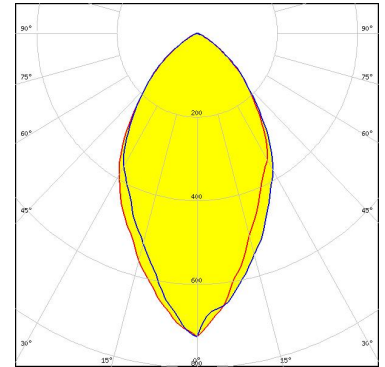

Light distribution files



LED XB-D
FWHM / FWTM 53.0° / 104.0°
Efficiency 73 %
Peak intensity 0.8 cd/lm
LEDs/each optic 1
Light colour/type White
Required components:

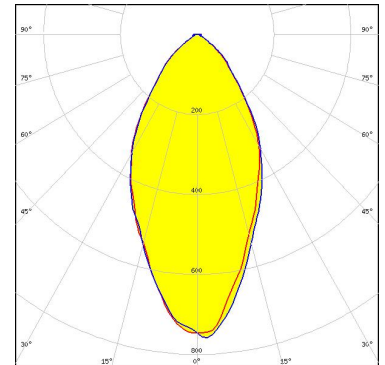

Light distribution files



LED XQ-E HD
FWHM / FWTM 70.0° / 126.0°
Efficiency 81 %
Peak intensity 0.6 cd/lm
LEDs/each optic 1
Light colour/type White
Required components:

Light distribution files

OPTICAL RESULTS (SIMULATED):



LED LUXEON IR 2720
FWHM / FWTM 68.0° / 120.0°
Efficiency 87 %
LEDs/each optic 1
Light colour/type IR
Required components:

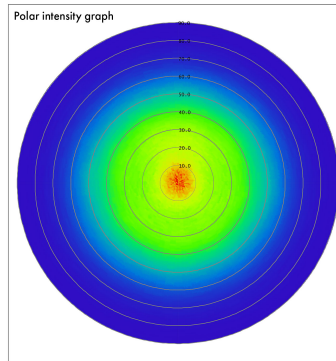

Light distribution files



LED LUXEON SunPlus 20 Line (150 deg)
FWHM / FWTM 84.0° / 140.0°
Efficiency 73 %
Peak intensity 0.4 cd/lm
LEDs/each optic 1
Light colour/type White
Required components:

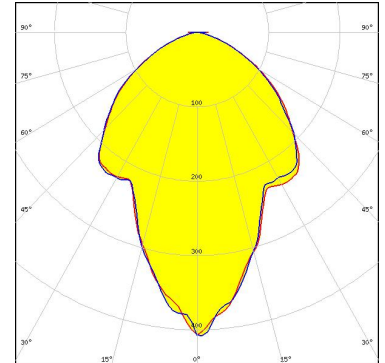

Light distribution files



LED LUXEON TX
FWHM / FWTM 80.0° / 130.0°
Efficiency 83 %
Peak intensity 0.5 cd/lm
LEDs/each optic 1
Light colour/type White
Required components:

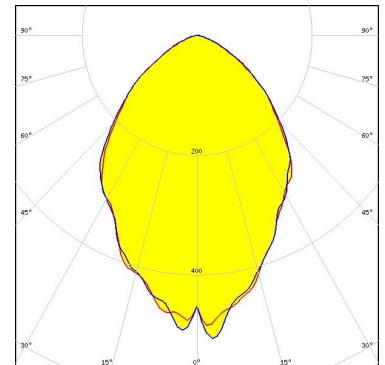

Light distribution files

OPTICAL RESULTS (SIMULATED):

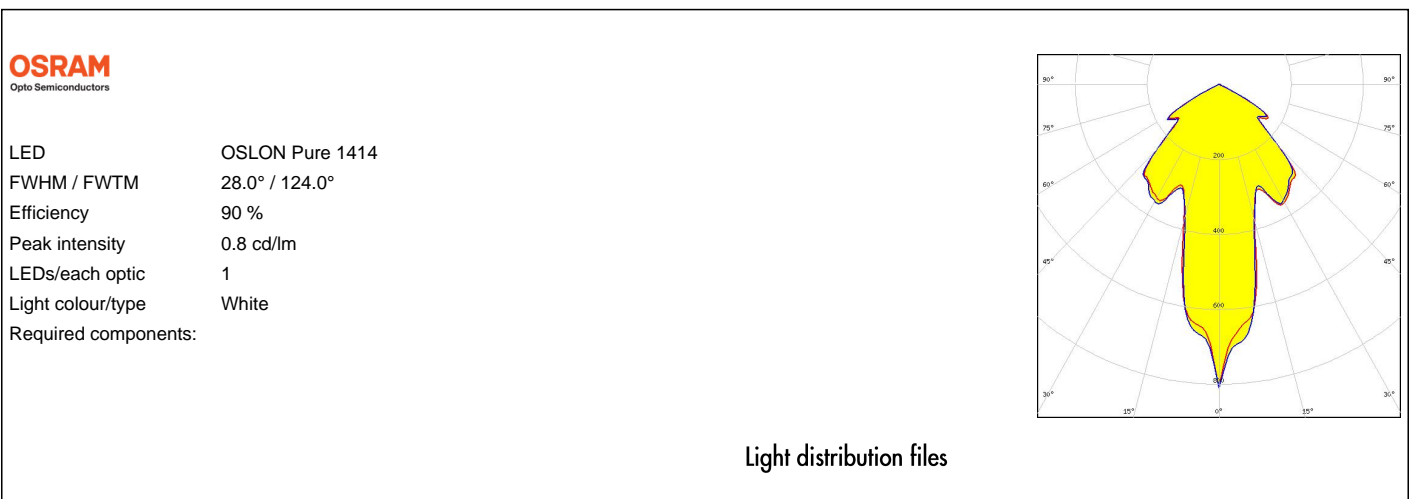
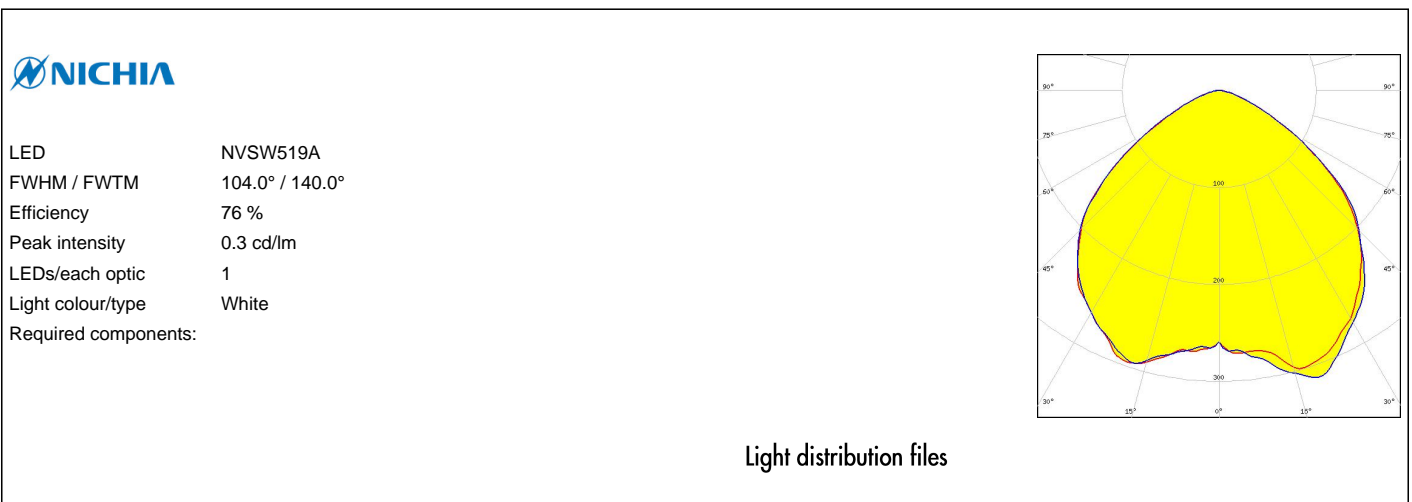
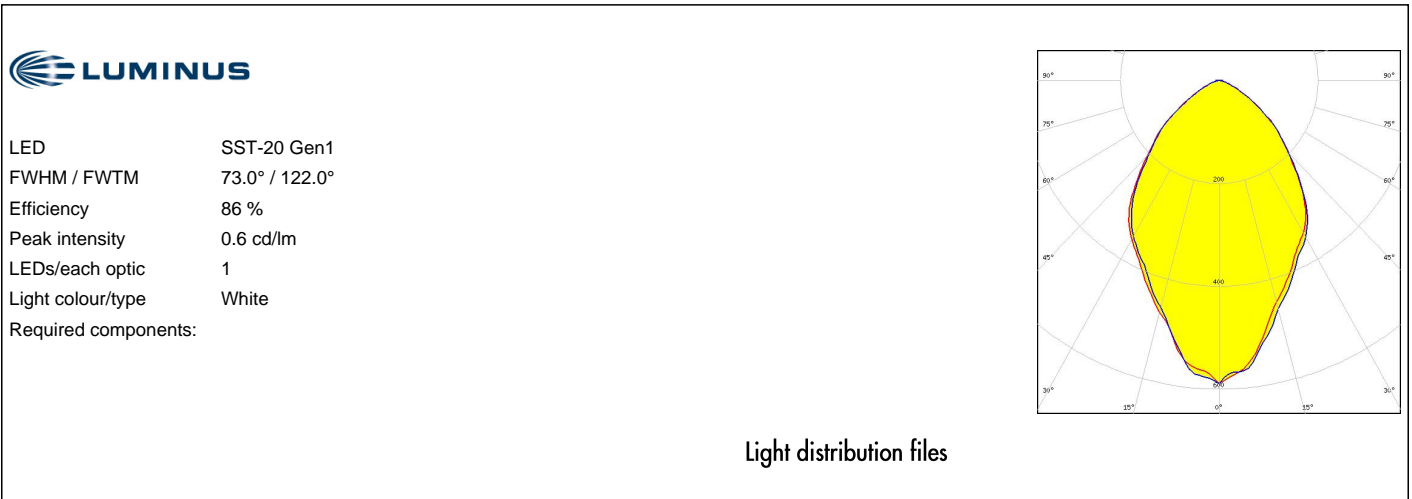

OPTICAL RESULTS (SIMULATED):

OSRAM
Opto Semiconductors

LED OSLON Signal
FWHM / FWTM 65.0 + 59.0° / 121.0°
Efficiency 87 %
Peak intensity 0.7 cd/lm
LEDs/each optic 1
Light colour/type Yellow
Required components:

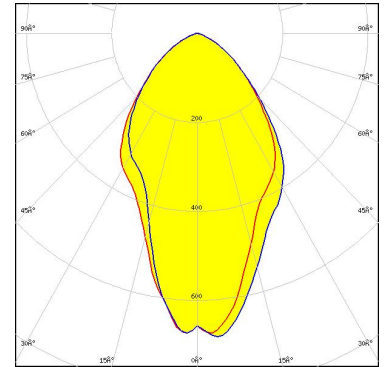

Light distribution files

OSRAM
Opto Semiconductors

LED OSLON Signal
FWHM / FWTM 85.0° / 129.0°
Efficiency 89 %
Peak intensity 0.5 cd/lm
LEDs/each optic 1
Light colour/type Green
Required components:

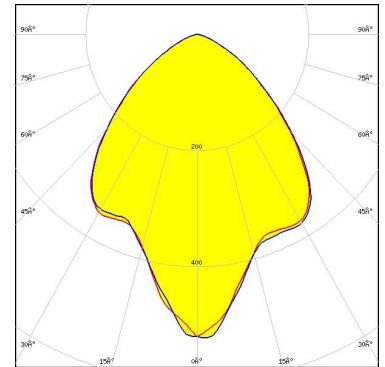

Light distribution files

OSRAM
Opto Semiconductors

LED OSLON Signal
FWHM / FWTM 86.0° / 136.0°
Efficiency 85 %
Peak intensity 0.5 cd/lm
LEDs/each optic 1
Light colour/type Red
Required components:

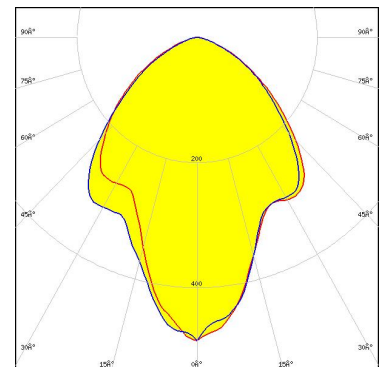

Light distribution files

OPTICAL RESULTS (SIMULATED):

OSRAM
Opto Semiconductors

LED OSLON SSL 120
 FWHM / FWTM 86.0° / 123.0°
 Efficiency 87 %
 Peak intensity 0.5 cd/lm
 LEDs/each optic 1
 Light colour/type Amber
 Required components:

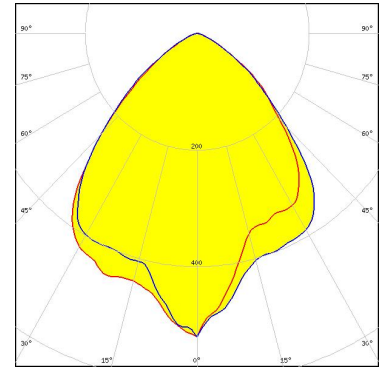

Light distribution files

OSRAM
Opto Semiconductors

LED SFH 4715AS
 FWHM / FWTM 52.0° / 102.0°
 Efficiency 88 %
 LEDs/each optic 1
 Light colour/type IR
 Required components:

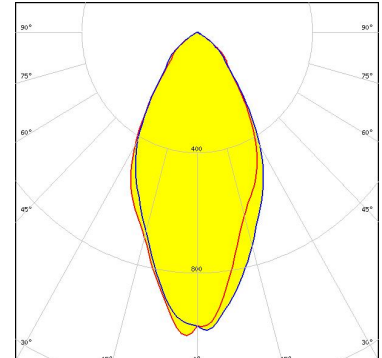
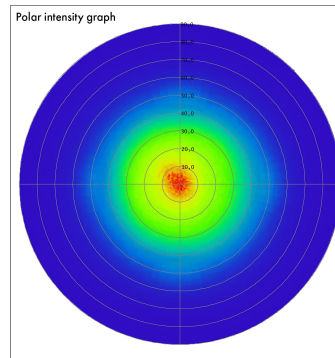

Light distribution files

OSRAM
Opto Semiconductors

LED SFH 4770S
 FWHM / FWTM 65.0° / 118.0°
 Efficiency 87 %
 LEDs/each optic 1
 Light colour/type IR
 Required components:

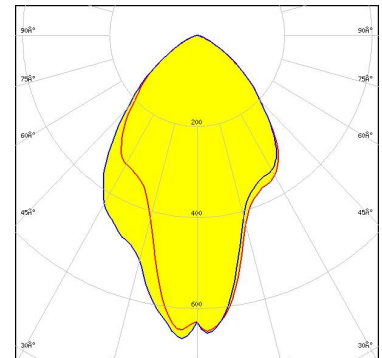
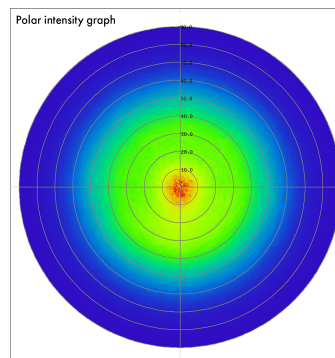

Light distribution files

OPTICAL RESULTS (SIMULATED):

SAMSUNG

LED LM301B
FWHM / FWTM 80.0° / 122.0°
Efficiency 86 %
Peak intensity 0.5 cd/lm
LEDs/each optic 1
Light colour/type White
Required components:

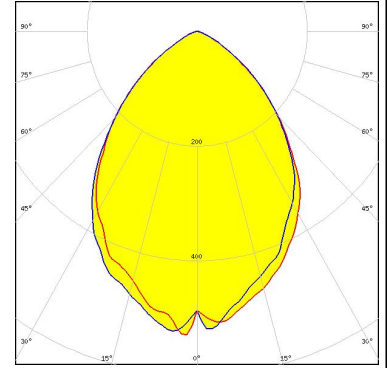

Light distribution files



LED Z5
FWHM / FWTM 70.0°
Efficiency %
LEDs/each optic 1
Light colour/type White
Required components:

Light distribution files

GENERAL INFORMATION:

NOTE: The typical beam angle will be changed by different color, chip size and chip position tolerance. The typical total beam angle is the full angle measured where the luminous intensity is half of the peak value.

MATERIALS:

As part of our continuous research and improvement processes, and to ensure the best possible quality and availability of our products, LEDiL reserves the right to change material grades without notice.

PRODUCT DATA USER AGREEMENT AND DISCLAIMER:

The measured data in the provided downloadable LEDiL Product Datasheets and Mechanical 2D-Drawings is rounded and provided as reference for planning. LEDiL Oy's optical specifications have been verified by conducting performance testing of the products in accordance with the company's quality system. The reported data are averaged results of multiple measurements with typical variation. LEDiL Oy reserves the right to without prior notification make changes and improvements to its products.

LEDiL Oy assumes neither warranty, nor guarantee nor any other liability of any kind for the contents and correctness of the provided data. The provided data has been generated with highest diligence but the provided data may in reality not represent the complete possible variation range of all intrinsic parameters. Therefore, in certain cases a deviation from the provided data could occur.

LEDiL Oy reserves the right to undertake technical changes of its products without further notification which could lead to changes in the provided data. LEDiL Oy assumes no liability of any kind for the possible deviation from any provided data or any other damage resulting from the usage of the provided data.

The user agrees to this disclaimer and user agreement with the download or usage of the provided files.

LEDiL Oy

Joensuunkatu 7
FI-24240 SALO
Finland

LEDiL Inc.

228 West Page Street
Suite D
Sycamore IL 60178
USA

Ledil Optics Technology (Shenzhen) Co., Ltd.

405 , Block B
Casic Motor Building
Shenzhen 518057
P.R.CHINA

Local sales and technical support

[www.ledil.com/
where_to_buy](http://www.ledil.com/where_to_buy)

Shipping locations

Poznan, Poland
Hong Kong, China

Distribution Partners

[www.ledil.com/
where_to_buy](http://www.ledil.com/where_to_buy)