

MIRELLA-50-S

~15° spot beam

SPECIFICATION:

Dimensions	Ø 49.9
Height	24 mm
Fastening	glue
ROHS compliant	yes ⓘ

MATERIALS:

Component	Type	Material	Colour	Finish	Coating
MIRELLA-50-S	Reflector	PC	metal		lacquer



ORDERING INFORMATION:

Component	Qty in box	MOQ	MPQ	Box weight (kg)
C12476_MIRELLA-50-S » Box size: 480 x 280 x 300 mm	336	112	28	3.0

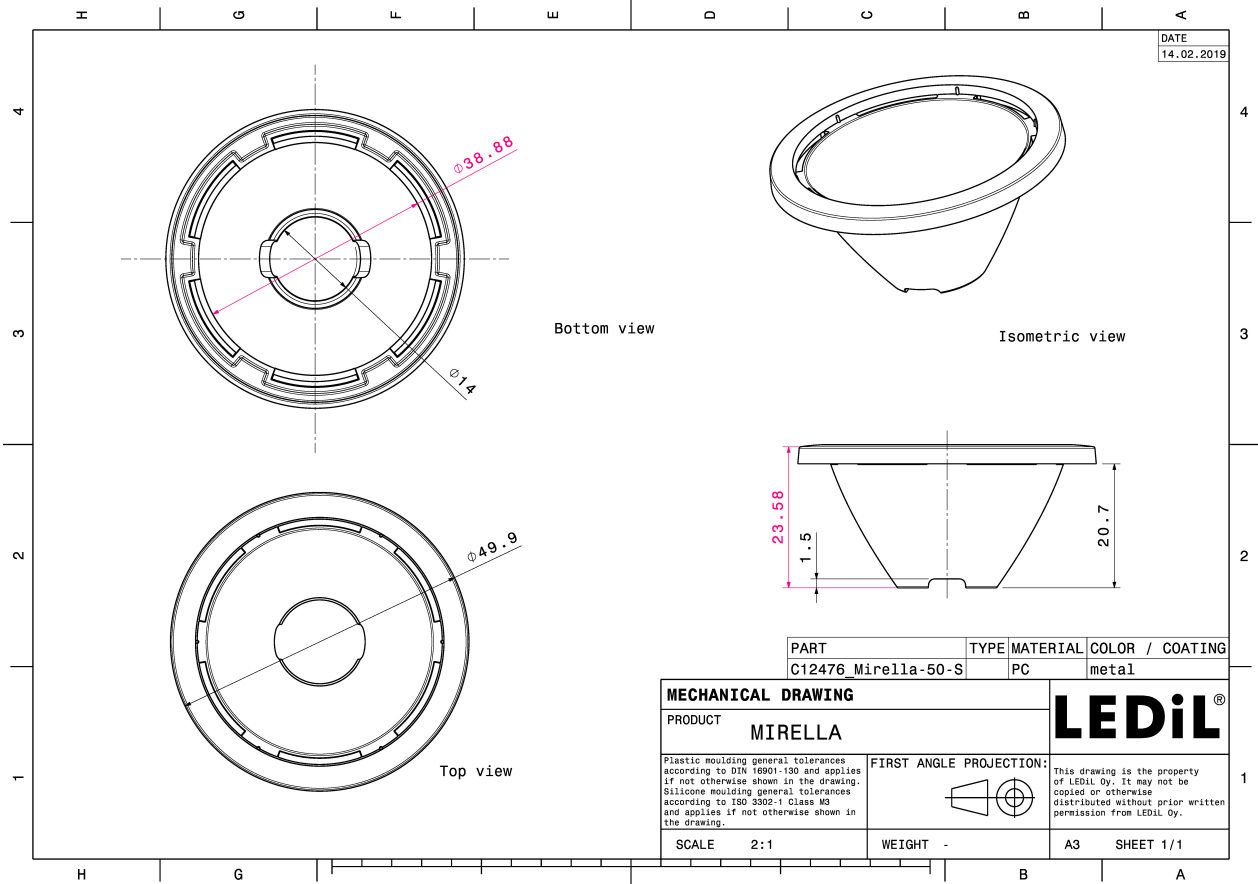

See also our general installation guide: www.ledil.com/installation_guide

OPTICAL RESULTS (MEASURED):

bridgelux

LED BXRA LS
 FWHM / FWTM 13.0° / 27.0°
 Efficiency 89 %
 Peak intensity 8.6 cd/lm
 LEDs/each optic 1
 Light colour/type White
 Required components:

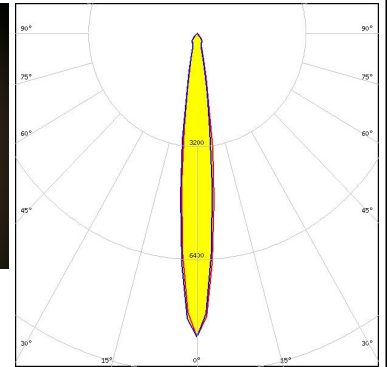

Light distribution files

bridgelux

LED BXRA LS
 FWHM / FWTM 18.0° / 48.0°
 Efficiency 83 %
 Peak intensity 4 cd/lm
 LEDs/each optic 1
 Light colour/type White
 Required components:
 C12479_MIRELLA-DL

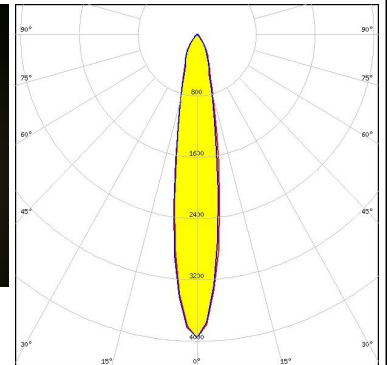
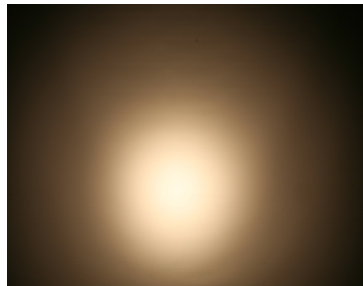

Light distribution files

bridgelux

LED BXRA LS
 FWHM / FWTM 14.0° / 28.0°
 Efficiency 84 %
 Peak intensity 6.7 cd/lm
 LEDs/each optic 1
 Light colour/type White
 Required components:
 C13333_MIRELLA-CL



Light distribution files

OPTICAL RESULTS (MEASURED):

CITIZEN

LED CLL01x
FWHM / FWTM 20.0° / 56.0°
Efficiency %
LEDs/each optic 1
Light colour/type White
Required components:
C12479_MIRELLA-DL



Light distribution files

CITIZEN

LED CLL01x
FWHM / FWTM 17.0° / 32.0°
Efficiency 84 %
Peak intensity 5.5 cd/lm
LEDs/each optic 1
Light colour/type White
Required components:
C13333_MIRELLA-CL



Light distribution files

CITIZEN

LED CLL02x/CLU02x (LES10)
FWHM / FWTM 28.0° / 67.0°
Efficiency 82 %
Peak intensity 2.1 cd/lm
LEDs/each optic 1
Light colour/type White
Required components:
C12479_MIRELLA-DL

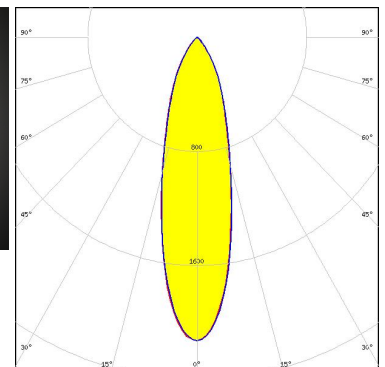
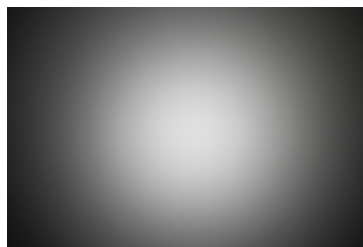

Light distribution files

OPTICAL RESULTS (MEASURED):

CITIZEN

LED CLL02x/CLU02x (LES10)
FWHM / FWTM 32.0° / 70.0°
Efficiency 81 %
Peak intensity 1.8 cd/m
LEDs/each optic 1
Light colour/type White
Required components:
C13723_MIRELLA-RZL

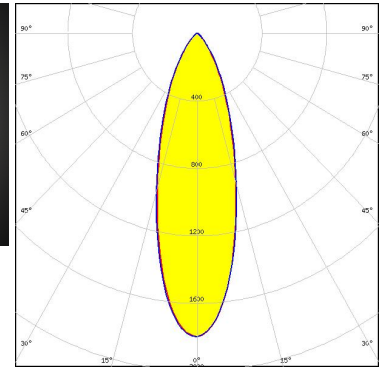
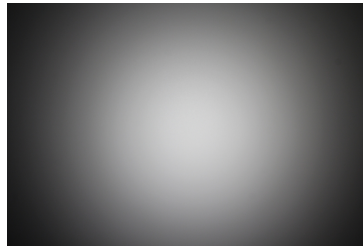

Light distribution files

CITIZEN

LED CLL02x/CLU02x (LES10)
FWHM / FWTM 19.0° / 50.0°
Efficiency 84 %
Peak intensity 3.6 cd/m
LEDs/each optic 1
Light colour/type White
Required components:
C13333_MIRELLA-CL



Light distribution files

CITIZEN

LED CLL02x/CLU02x (LES10)
FWHM / FWTM 20.0° / 48.0°
Efficiency 93 %
LEDs/each optic 1
Light colour/type White
Required components:



Light distribution files

OPTICAL RESULTS (MEASURED):

CITIZEN

LED CLU700/701/702/703
FWHM / FWTM 26.0° / 64.0°
Efficiency 83 %
Peak intensity 2.3 cd/lm
LEDs/each optic 1
Light colour/type White
Required components:
C13723_MIRELLA-RZL

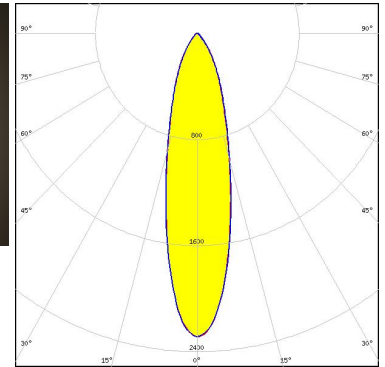
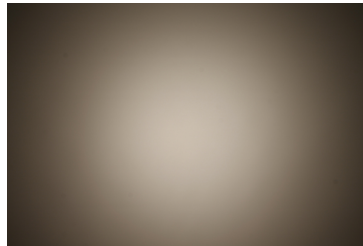

Light distribution files

CITIZEN

LED CLU700/701/702/703
FWHM / FWTM 15.0° / 32.0°
Efficiency 90 %
Peak intensity 6.2 cd/lm
LEDs/each optic 1
Light colour/type White
Required components:

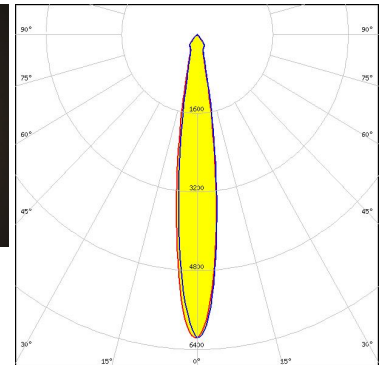

Light distribution files

CITIZEN

LED CLU700/701/702/703
FWHM / FWTM 15.0° / 32.0°
Efficiency 85 %
Peak intensity 5.9 cd/lm
LEDs/each optic 1
Light colour/type White
Required components:
C13333_MIRELLA-CL

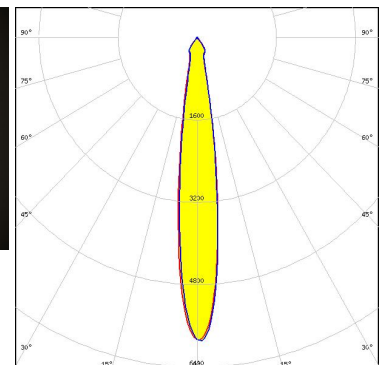

Light distribution files

OPTICAL RESULTS (MEASURED):

CITIZEN

LED CLU700/701/702/703
FWHM / FWTM 21.0° / 59.0°
Efficiency 84 %
Peak intensity 3.1 cd/lm
LEDs/each optic 1
Light colour/type White
Required components:
C12479_MIRELLA-DL

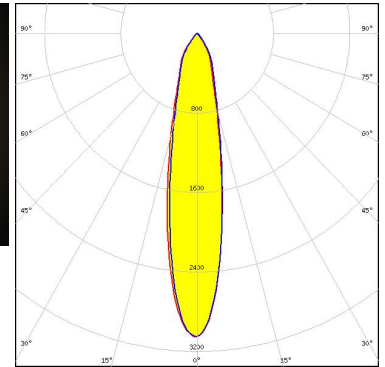

Light distribution files

CITIZEN

LED CLU710/711
FWHM / FWTM 20.0° / 54.0°
Efficiency 85 %
Peak intensity 3.4 cd/lm
LEDs/each optic 1
Light colour/type White
Required components:
C13333_MIRELLA-CL

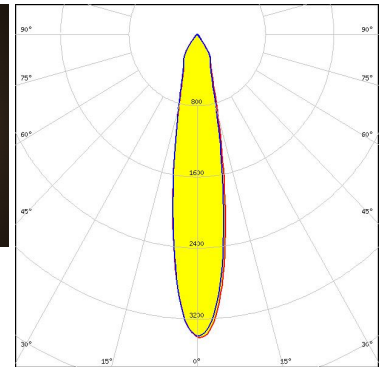
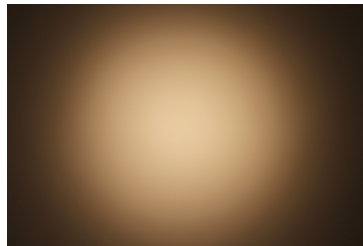

Light distribution files

CITIZEN

LED CLU710/711
FWHM / FWTM 20.0° / 49.0°
Efficiency 90 %
Peak intensity 3.7 cd/lm
LEDs/each optic 1
Light colour/type White
Required components:

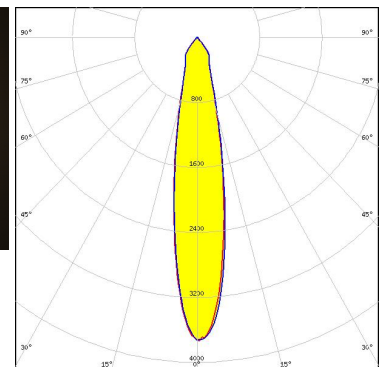
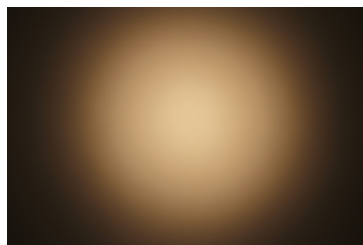

Light distribution files

OPTICAL RESULTS (MEASURED):

CITIZEN

LED CLU710/711
FWHM / FWTM 26.0° / 67.0°
Efficiency 83 %
Peak intensity 2.1 cd/lm
LEDs/each optic 1
Light colour/type White
Required components:
C12479_MIRELLA-DL

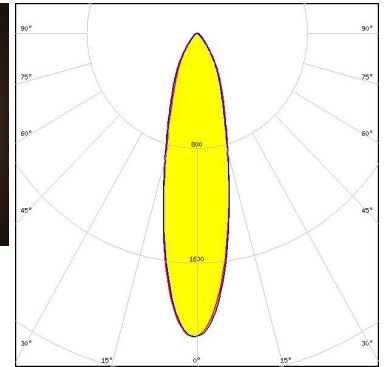

Light distribution files

CITIZEN

LED CLU710/711
FWHM / FWTM 29.0° / 69.0°
Efficiency 83 %
Peak intensity 1.9 cd/lm
LEDs/each optic 1
Light colour/type White
Required components:
C13723_MIRELLA-RZL

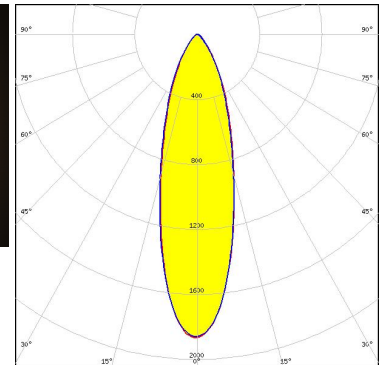
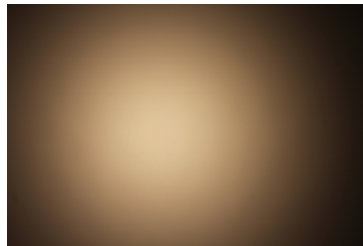

Light distribution files

CITIZEN

LED CLU720/721/723
FWHM / FWTM 25.0° / 66.0°
Efficiency 85 %
Peak intensity 2.5 cd/lm
LEDs/each optic 1
Light colour/type White
Required components:
C13333_MIRELLA-CL

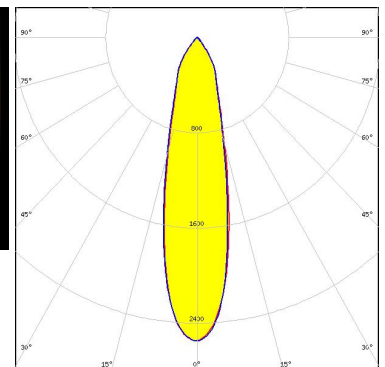
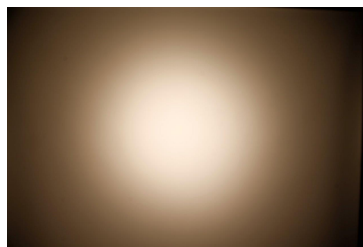

Light distribution files

OPTICAL RESULTS (MEASURED):

CITIZEN

LED CLU720/721/723
 FWHM / FWTM 24.0° / 68.0°
 Efficiency 90 %
 Peak intensity 2.4 cd/lm
 LEDs/each optic 1
 Light colour/type White
 Required components:

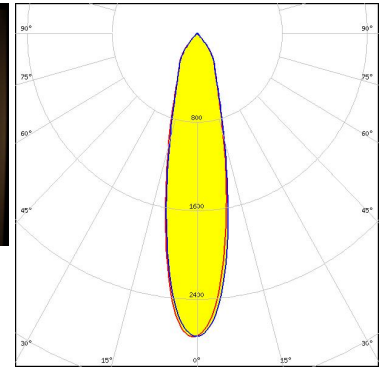
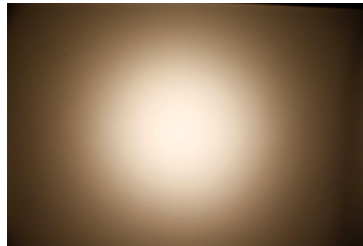

Light distribution files

CITIZEN

LED CLU720/721/723
 FWHM / FWTM 30.0° / 71.0°
 Efficiency 82 %
 Peak intensity 1.8 cd/lm
 LEDs/each optic 1
 Light colour/type White
 Required components:
 C12479_MIRELLA-DL

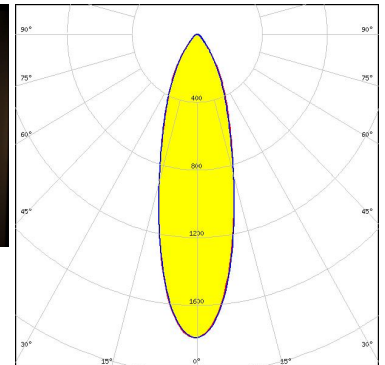
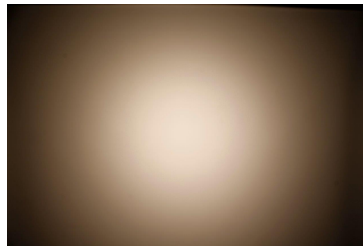

Light distribution files

CITIZEN

LED CLU720/721/723
 FWHM / FWTM 32.0° / 73.0°
 Efficiency 83 %
 Peak intensity 1.7 cd/lm
 LEDs/each optic 1
 Light colour/type White
 Required components:
 C13723_MIRELLA-RZL

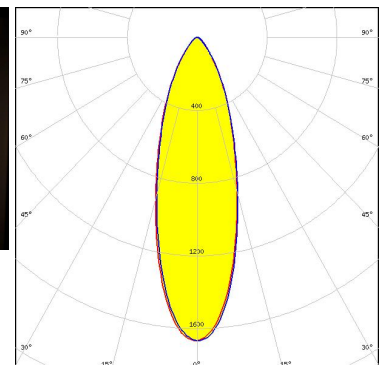
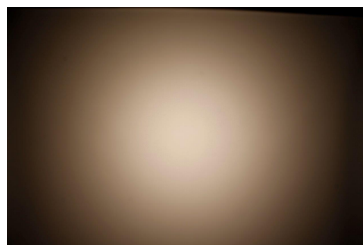

Light distribution files

OPTICAL RESULTS (MEASURED):



LED CXA/B 13xx
FWHM / FWTM 15.0° / 36.0°
Efficiency 81 %
Peak intensity 5.4 cd/lm
LEDs/each optic 1
Light colour/type White

Required components:

C12479_MIRELLA-DL



Light distribution files



LED CXA/B 13xx
FWHM / FWTM 12.0° / 25.0°
Efficiency 82 %
Peak intensity 8.5 cd/lm
LEDs/each optic 1
Light colour/type White

Required components:

C13333_MIRELLA-CL



Light distribution files



LED CXA/B 13xx
FWHM / FWTM 12.0° / 25.0°
Efficiency 87 %
Peak intensity 9.5 cd/lm
LEDs/each optic 1
Light colour/type White

Required components:



Light distribution files

OPTICAL RESULTS (MEASURED):



LED CXA/B 15xx
FWHM / FWTM 19.0° / 47.0°
Efficiency 84 %
Peak intensity 4.3 cd/lm
LEDs/each optic 1
Light colour/type White
Required components:
C13333_MIRELLA-CL



Light distribution files



LED CXA/B 15xx
FWHM / FWTM 20.0° / 60.0°
Efficiency 90 %
Peak intensity 3.1 cd/lm
LEDs/each optic 1
Light colour/type White
Required components:
C12479_MIRELLA-DL

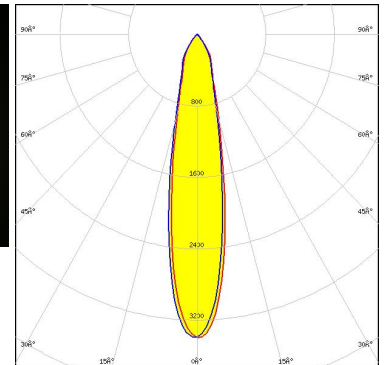

Light distribution files



LED CXA/B 15xx
FWHM / FWTM 16.0° / 38.0°
Efficiency 93 %
Peak intensity 5.1 cd/lm
LEDs/each optic 1
Light colour/type White
Required components:

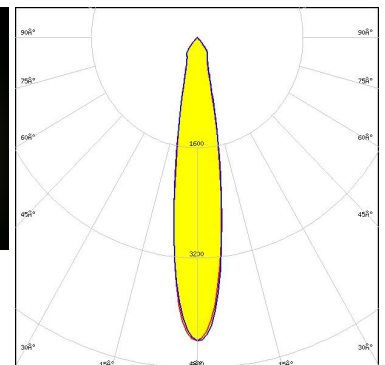
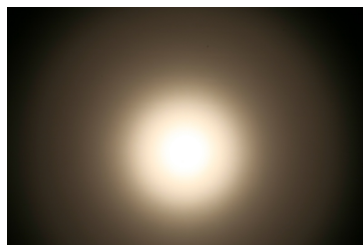

Light distribution files

OPTICAL RESULTS (MEASURED):



LED CXA/B 1816 & CXA/B 1820 & CXA 1850
FWHM / FWTM 26.0° / 68.0°
Efficiency 83 %
Peak intensity 2.6 cd/lm
LEDs/each optic 1
Light colour/type White
Required components:
C12479_MIRELLA-DL

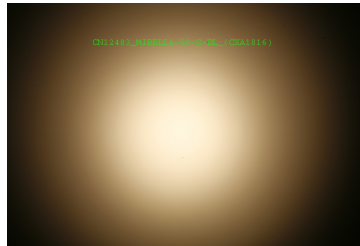

Light distribution files



LED CXA/B 1816 & CXA/B 1820 & CXA 1850
FWHM / FWTM 25.0° / 68.0°
Efficiency 83 %
Peak intensity 2.9 cd/lm
LEDs/each optic 1
Light colour/type White
Required components:
C13333_MIRELLA-CL

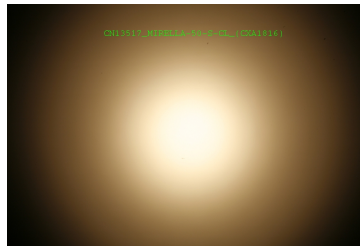

Light distribution files



LED CXA/B 1816 & CXA/B 1820 & CXA 1850
FWHM / FWTM 23.0° / 68.0°
Efficiency 89 %
Peak intensity 3.2 cd/lm
LEDs/each optic 1
Light colour/type White
Required components:

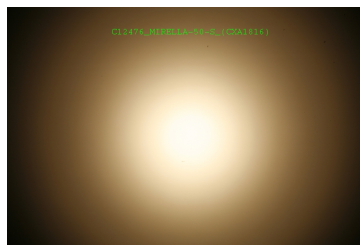

Light distribution files

OPTICAL RESULTS (MEASURED):



LED MHD-E/G
 FWHM / FWTM 18.0° / 40.0°
 Efficiency 89 %
 Peak intensity 4.2 cd/lm
 LEDs/each optic 1
 Light colour/type White
 Required components:
 C13333_MIRELLA-CL

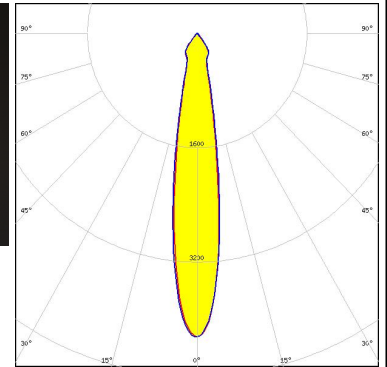

Light distribution files



LED MHD-E/G
 FWHM / FWTM 20.0° / 57.0°
 Efficiency 88 %
 Peak intensity 3.3 cd/lm
 LEDs/each optic 1
 Light colour/type White
 Required components:
 C12479_MIRELLA-DL

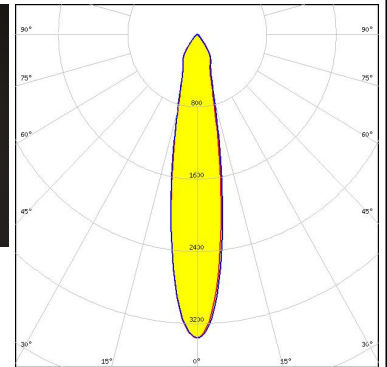

Light distribution files



LED MHD-E/G
 FWHM / FWTM 16.0° / 35.0°
 Efficiency 94 %
 Peak intensity 5 cd/lm
 LEDs/each optic 1
 Light colour/type White
 Required components:

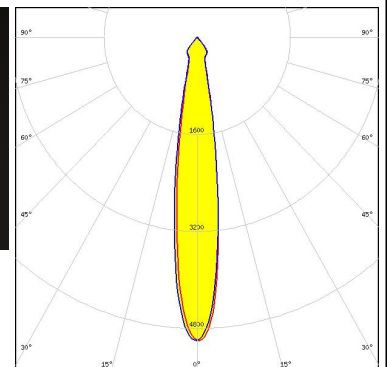
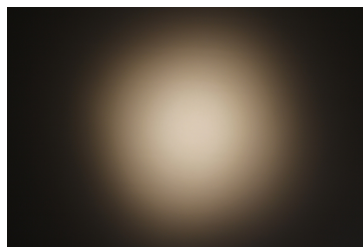

Light distribution files

OPTICAL RESULTS (MEASURED):



LED MT-G2
 FWHM / FWTM 17.0° / 35.0°
 Efficiency 92 %
 Peak intensity 5.5 cd/lm
 LEDs/each optic 1
 Light colour/type White
 Required components:

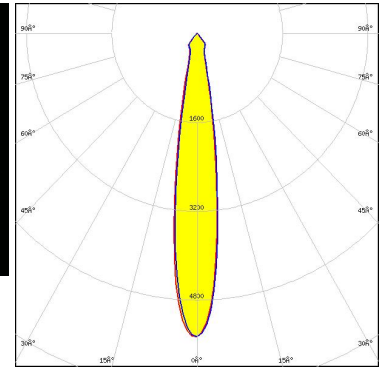

Light distribution files



LED MT-G2
 FWHM / FWTM 20.0° / 50.0°
 Efficiency 85 %
 Peak intensity 3.7 cd/lm
 LEDs/each optic 1
 Light colour/type White
 Required components:
 C12479_MIRELLA-DL

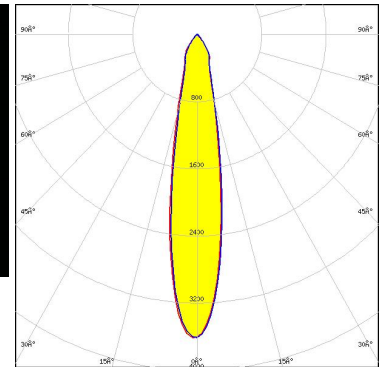

Light distribution files



LED MT-G2
 FWHM / FWTM 18.0° / 37.0°
 Efficiency 85 %
 Peak intensity 4.7 cd/lm
 LEDs/each optic 1
 Light colour/type White
 Required components:
 C13333_MIRELLA-CL



Light distribution files

OPTICAL RESULTS (MEASURED):



LED XHP50
 FWHM / FWTM 14.0° / 30.0°
 Efficiency 86 %
 Peak intensity 6.2 cd/lm
 LEDs/each optic 1
 Light colour/type White
 Required components:
 C13333_MIRELLA-CL

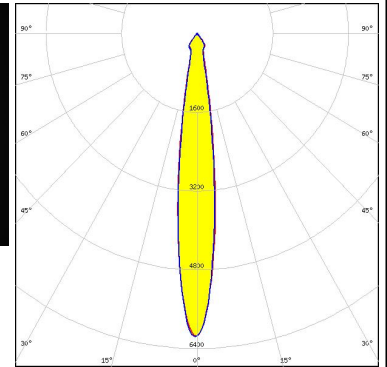

Light distribution files



LED XHP50
 FWHM / FWTM 17.0° / 44.0°
 Efficiency 85 %
 Peak intensity 4.1 cd/lm
 LEDs/each optic 1
 Light colour/type White
 Required components:
 C12479_MIRELLA-DL

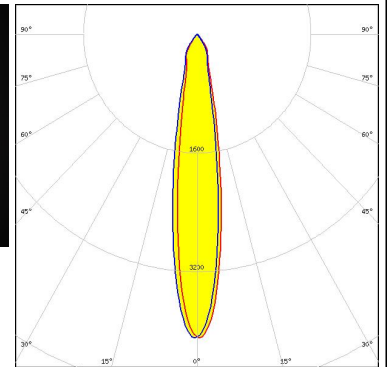

Light distribution files



LED XHP50
 FWHM / FWTM 14.0° / 28.0°
 Efficiency 92 %
 Peak intensity 7.2 cd/lm
 LEDs/each optic 1
 Light colour/type White
 Required components:

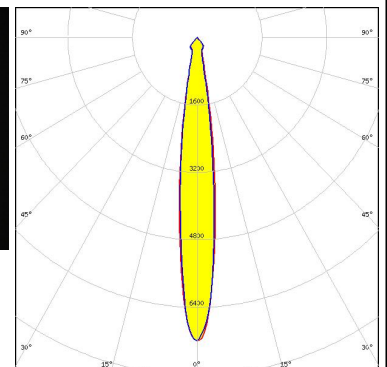
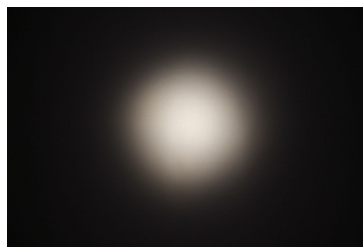

Light distribution files

OPTICAL RESULTS (MEASURED):



LED XHP70
 FWHM / FWTM 17.0° / 34.0°
 Efficiency 90 %
 Peak intensity 5.5 cd/lm
 LEDs/each optic 1
 Light colour/type White
 Required components:

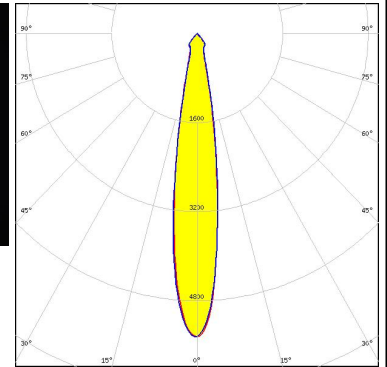

Light distribution files



LED XHP70
 FWHM / FWTM 18.0° / 36.0°
 Efficiency 86 %
 Peak intensity 4.8 cd/lm
 LEDs/each optic 1
 Light colour/type White
 Required components:
 C13333_MIRELLA-CL

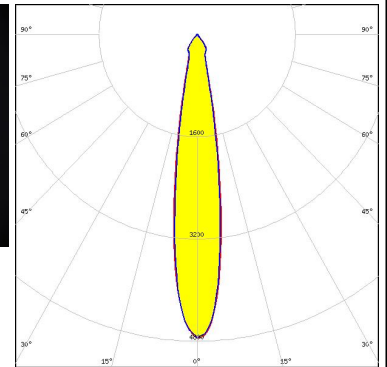

Light distribution files



LED XHP70
 FWHM / FWTM 19.0° / 44.0°
 Efficiency 86 %
 Peak intensity 4 cd/lm
 LEDs/each optic 1
 Light colour/type White
 Required components:
 C12479_MIRELLA-DL

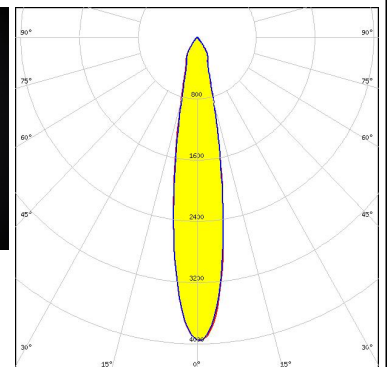
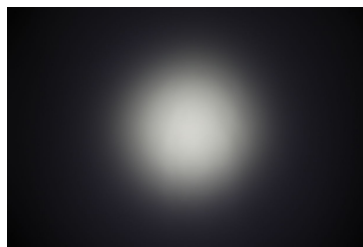

Light distribution files

OPTICAL RESULTS (MEASURED):



LED LUXEON CoB 1202/1203
 FWHM / FWTM 21.0° / 52.0°
 Efficiency 86 %
 Peak intensity 3.6 cd/lm
 LEDs/each optic 1
 Light colour/type White
 Required components:
 C13333_MIRELLA-CL

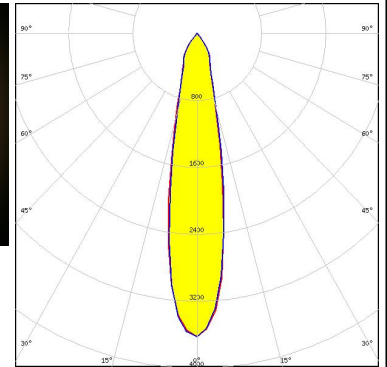

Light distribution files



LED LUXEON CoB 1202/1203
 FWHM / FWTM 20.0° / 49.0°
 Efficiency 89 %
 Peak intensity 3.9 cd/lm
 LEDs/each optic 1
 Light colour/type White
 Required components:

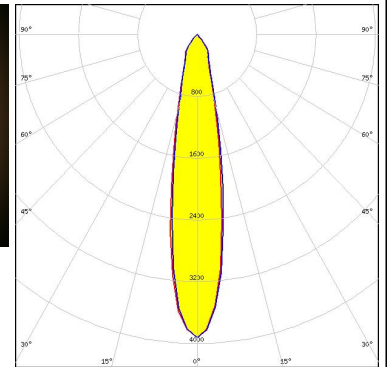

Light distribution files



LED LUXEON CoB 1202/1203
 FWHM / FWTM 23.0° / 60.0°
 Efficiency 85 %
 Peak intensity 3.1 cd/lm
 LEDs/each optic 1
 Light colour/type White
 Required components:
 C12479_MIRELLA-DL

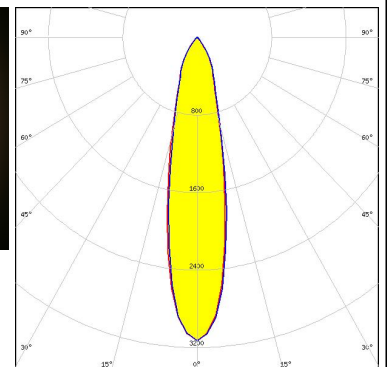
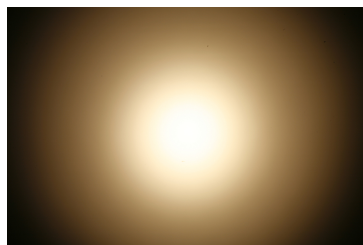

Light distribution files

OPTICAL RESULTS (MEASURED):



LED LUXEON S1000
FWHM / FWTM 21.0° / 60.0°
Efficiency %
LEDs/each optic 1
Light colour/type White
Required components:
C12479_MIRELLA-DL



Light distribution files



LED LUXEON S1000
FWHM / FWTM 14.0° / 37.0°
Efficiency 84 %
Peak intensity 5.5 cd/m
LEDs/each optic 1
Light colour/type White
Required components:
C13333_MIRELLA-CL



Light distribution files



LED LUXEON S1000
FWHM / FWTM 17.0° / 38.0°
Efficiency %
LEDs/each optic 1
Light colour/type White
Required components:



Light distribution files

OPTICAL RESULTS (MEASURED):

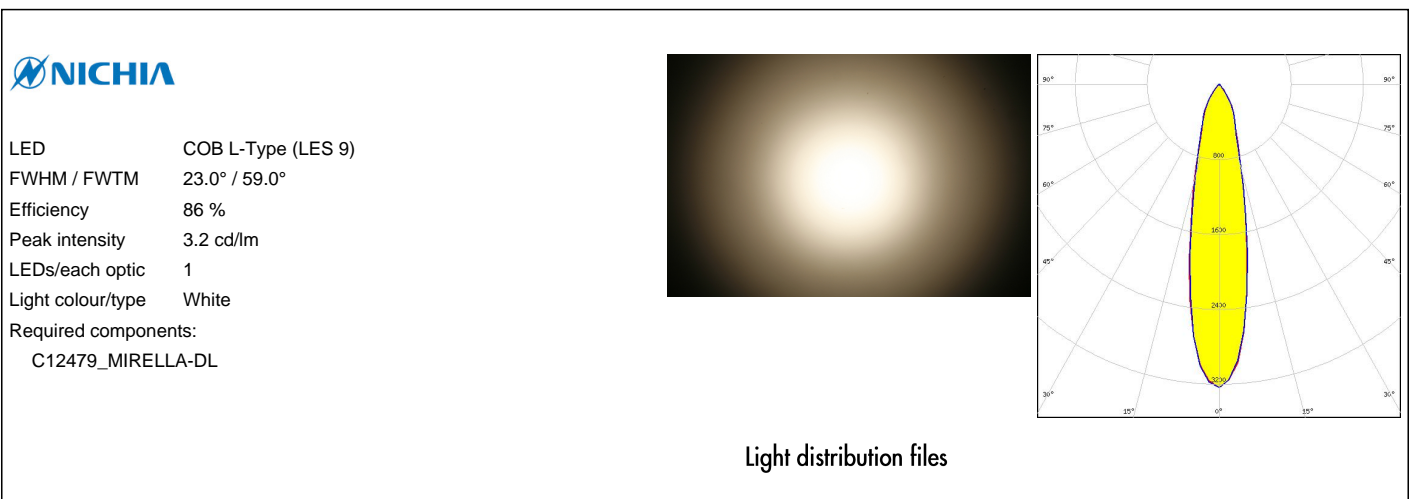
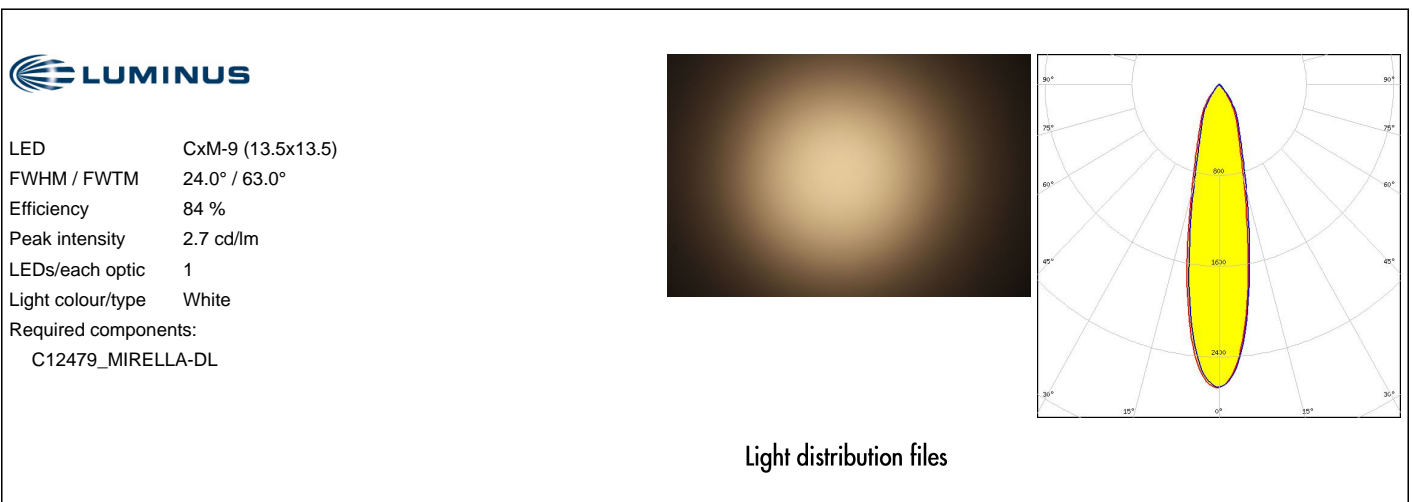
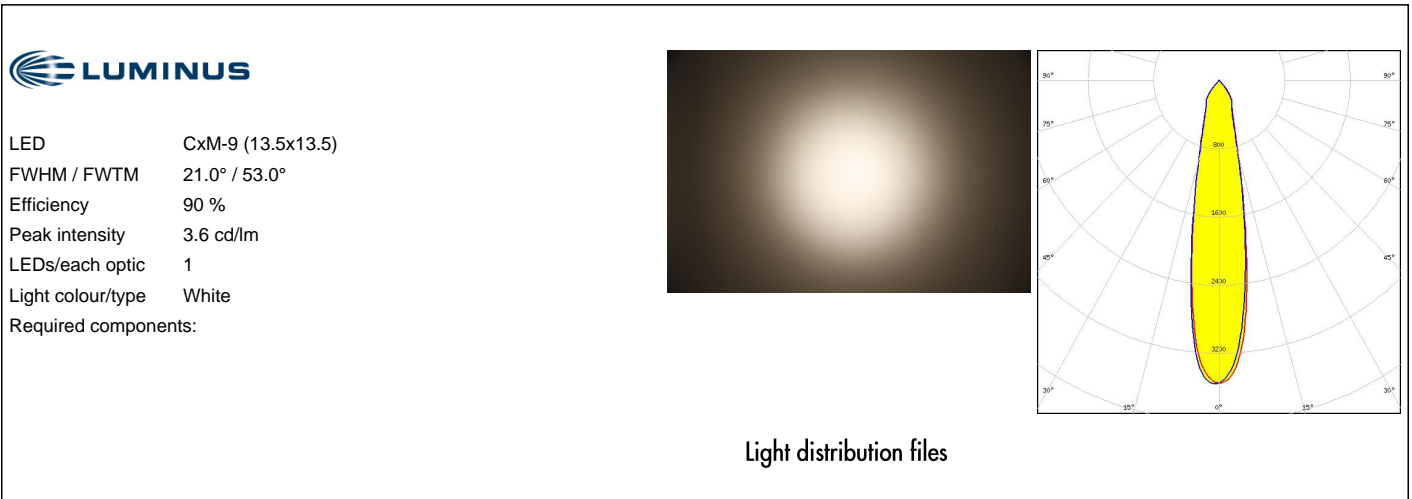

OPTICAL RESULTS (MEASURED):



LED COB L-Type (LES 9)
FWHM / FWTM 22.0° / 53.0°
Efficiency 87 %
Peak intensity 3.7 cd/lm
LEDs/each optic 1
Light colour/type White
Required components:
 C13333_MIRELLA-CL

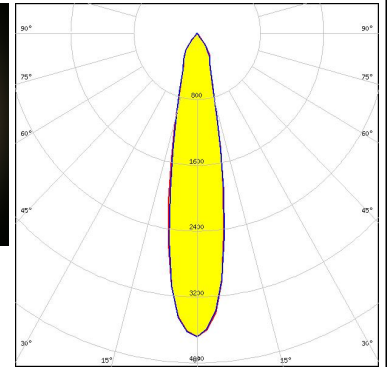

Light distribution files



LED COB L-Type (LES 9)
FWHM / FWTM 20.0° / 48.0°
Efficiency 90 %
Peak intensity 4 cd/lm
LEDs/each optic 1
Light colour/type White
Required components:

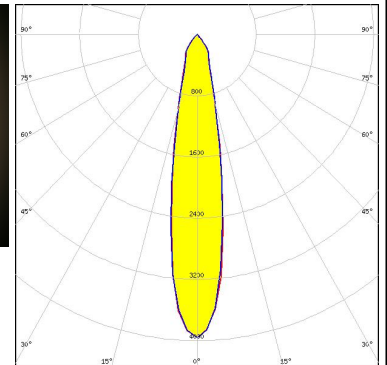

Light distribution files



LED NFMW48xA
FWHM / FWTM 9.5° / 20.0°
Efficiency 88 %
Peak intensity 13.6 cd/lm
LEDs/each optic 1
Light colour/type White
Required components:

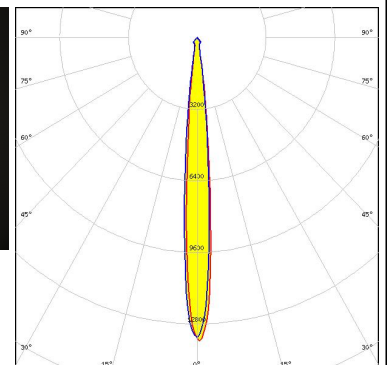

Light distribution files

OPTICAL RESULTS (MEASURED):



LED NSCxL036A
 FWHM / FWTM 19.0° / 46.0°
 Efficiency 84 %
 Peak intensity 4.2 cd/lm
 LEDs/each optic 1
 Light colour/type White
 Required components:
 C12479_MIRELLA-DL

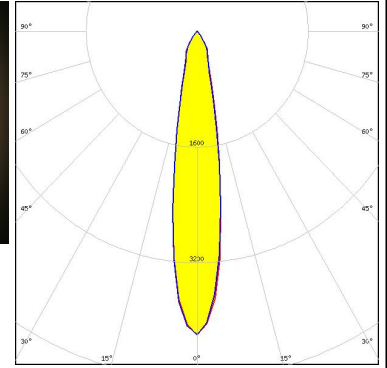

Light distribution files



LED NSCxL036A
 FWHM / FWTM 17.0° / 37.0°
 Efficiency 84 %
 Peak intensity 5 cd/lm
 LEDs/each optic 1
 Light colour/type White
 Required components:
 C13333_MIRELLA-CL

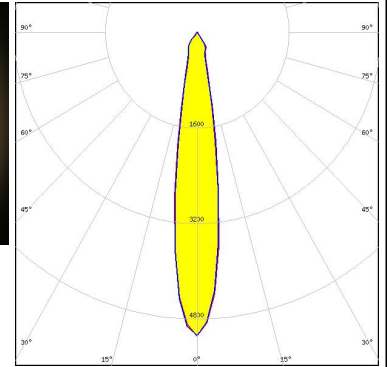

Light distribution files



LED NSCxL036A
 FWHM / FWTM 17.0° / 35.0°
 Efficiency 88 %
 Peak intensity 5.6 cd/lm
 LEDs/each optic 1
 Light colour/type White
 Required components:

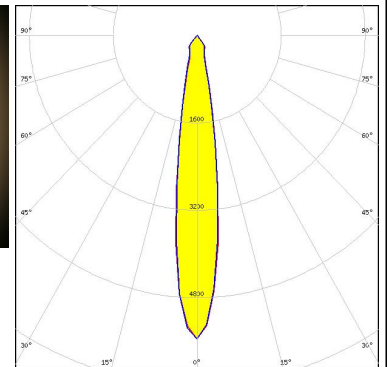
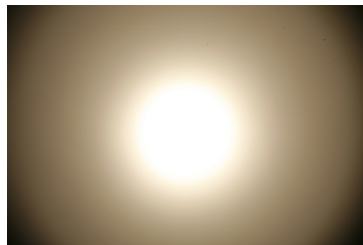

Light distribution files

OPTICAL RESULTS (MEASURED):

OSRAM
Opto Semiconductors

LED Duris S10
FWHM / FWTM 15.0° / 33.0°
Efficiency 83 %
Peak intensity 6.7 cd/lm
LEDs/each optic 1
Light colour/type White

Required components:

C13333_MIRELLA-CL



Light distribution files

OSRAM
Opto Semiconductors

LED Duris S10
FWHM / FWTM 20.0° / 57.0°
Efficiency 81 %
Peak intensity 3.4 cd/lm
LEDs/each optic 1
Light colour/type White

Required components:

C12479_MIRELLA-DL

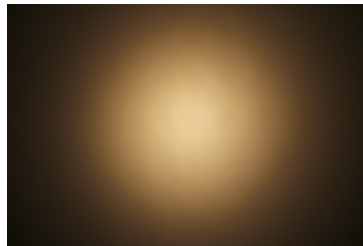

Light distribution files

OSRAM
Opto Semiconductors

LED Duris S10
FWHM / FWTM 15.0° / 33.0°
Efficiency 89 %
Peak intensity 6.5 cd/lm
LEDs/each optic 1
Light colour/type White

Required components:

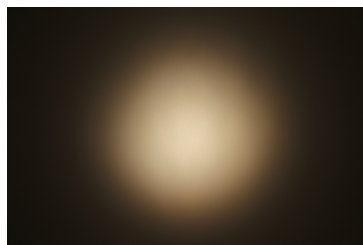

Light distribution files

OPTICAL RESULTS (MEASURED):

OSRAM
Opto Semiconductors

LED Soleriq S13
 FWHM / FWTM 30.0° / 70.0°
 Efficiency 83 %
 Peak intensity 2.1 cd/lm
 LEDs/each optic 1
 Light colour/type White
 Required components:
 C12479_MIRELLA-DL

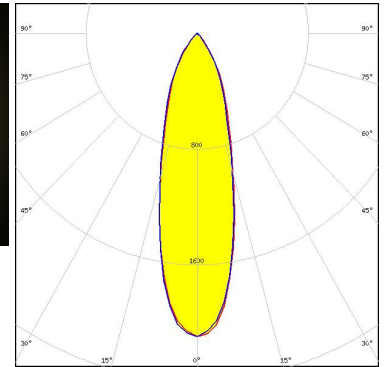

Light distribution files

OSRAM
Opto Semiconductors

LED Soleriq S13
 FWHM / FWTM 27.0° / 70.0°
 Efficiency 87 %
 Peak intensity 2.5 cd/lm
 LEDs/each optic 1
 Light colour/type White
 Required components:

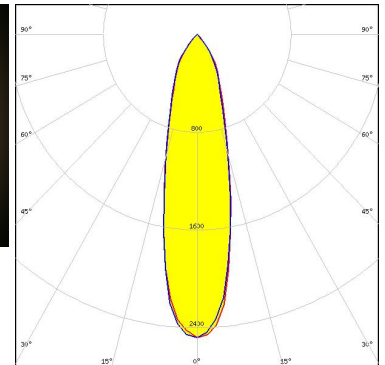
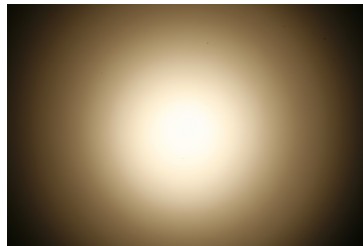

Light distribution files

OSRAM
Opto Semiconductors

LED Soleriq S13
 FWHM / FWTM 28.0° / 69.0°
 Efficiency 82 %
 Peak intensity 2.3 cd/lm
 LEDs/each optic 1
 Light colour/type White
 Required components:
 C13333_MIRELLA-CL

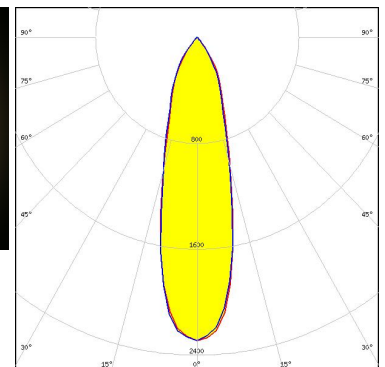
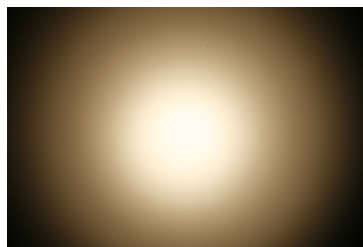

Light distribution files

OPTICAL RESULTS (MEASURED):

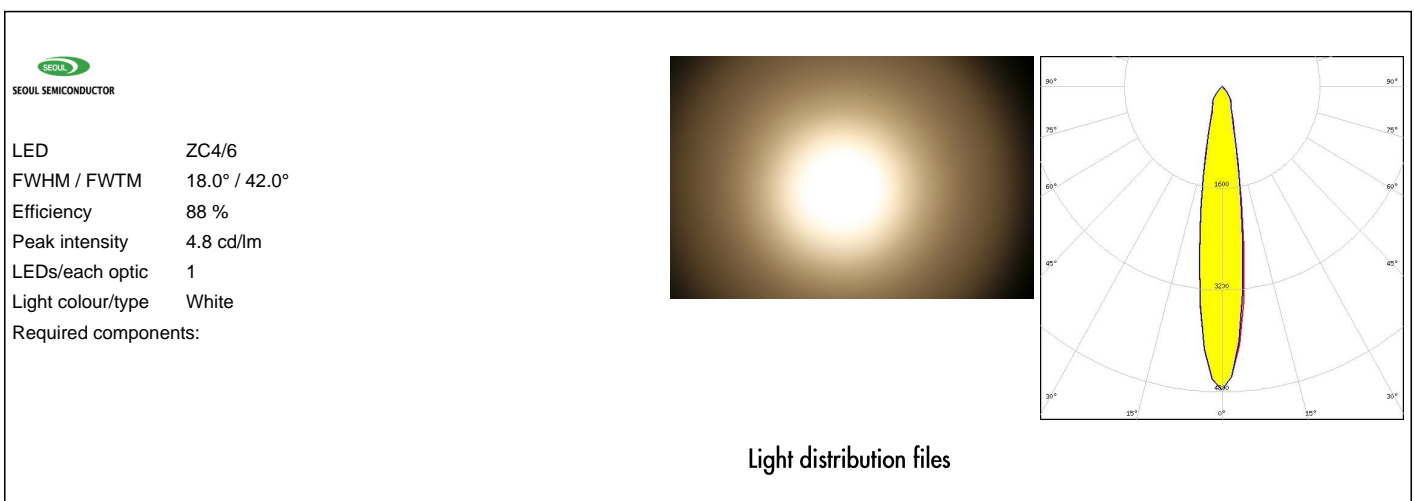
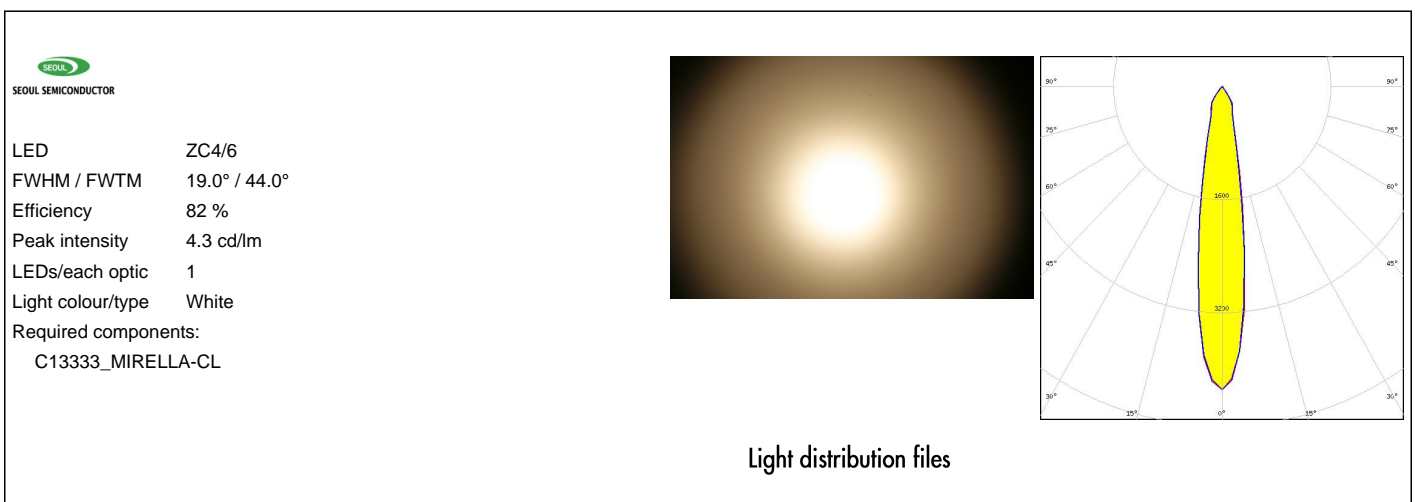
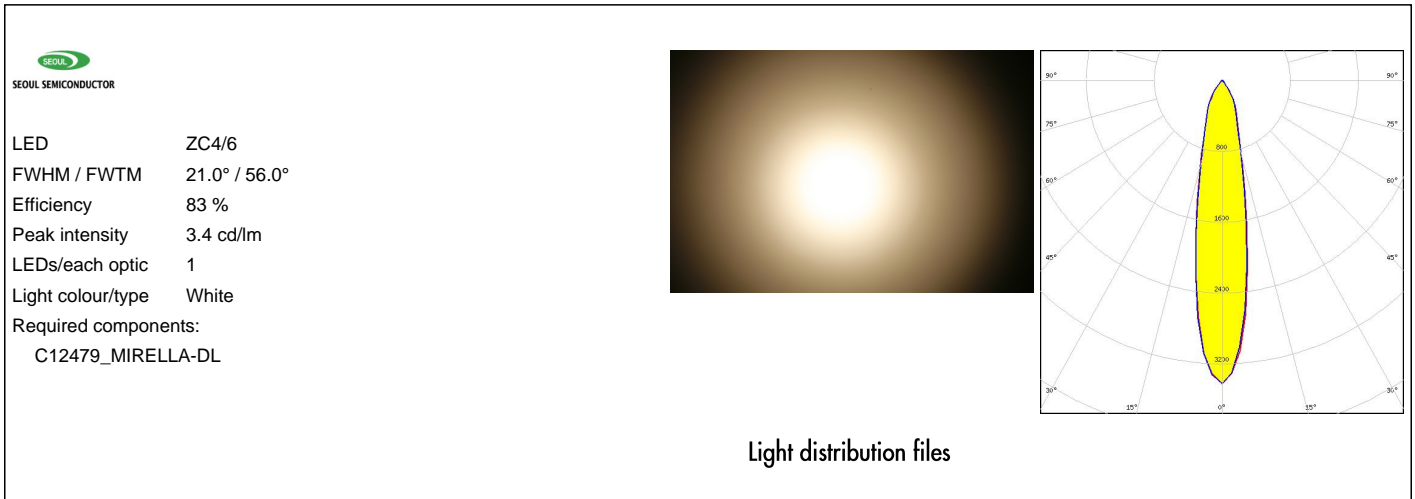

OPTICAL RESULTS (MEASURED):

SHARP

LED Mini Zenigata (GW5BM)
FWHM / FWTM 17.0° / 39.0°
Efficiency 92 %
Peak intensity 4.8 cd/lm
LEDs/each optic 1
Light colour/type White
Required components:

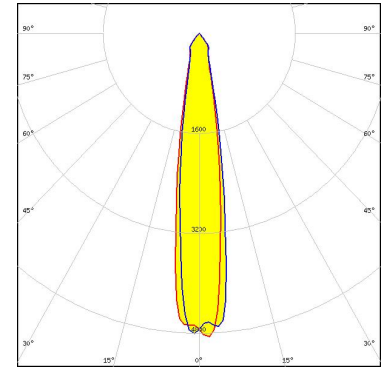

Light distribution files

SHARP

LED Mini Zenigata (GW5BM)
FWHM / FWTM 20.0° / 54.0°
Efficiency 86 %
Peak intensity 3.5 cd/lm
LEDs/each optic 1
Light colour/type White
Required components:
C12479_MIRELLA-DL

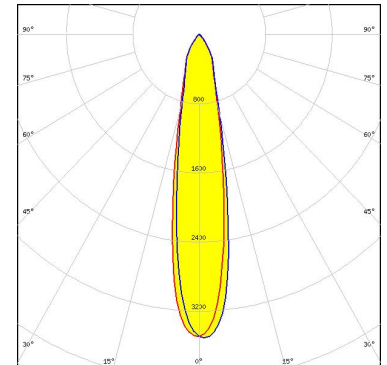

Light distribution files

SHARP

LED Mini Zenigata (GW6BM)
FWHM / FWTM 20.0° / 56.0°
Efficiency 84 %
Peak intensity 3.2 cd/lm
LEDs/each optic 1
Light colour/type White
Required components:
C12479_MIRELLA-DL

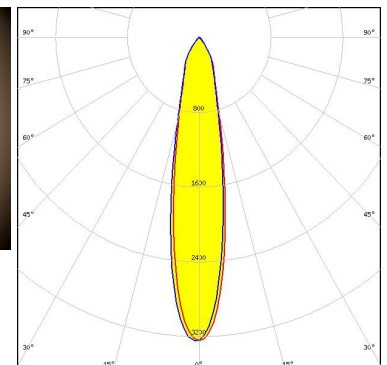
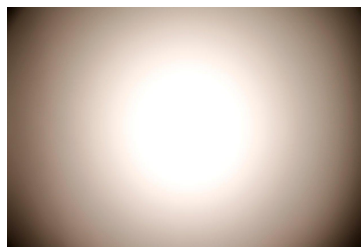

Light distribution files

OPTICAL RESULTS (MEASURED):

SHARP

LED Mini Zenigata (GW6BM)
FWHM / FWTM 17.0° / 41.0°
Efficiency 91 %
Peak intensity 4.8 cd/lm
LEDs/each optic 1
Light colour/type White
Required components:

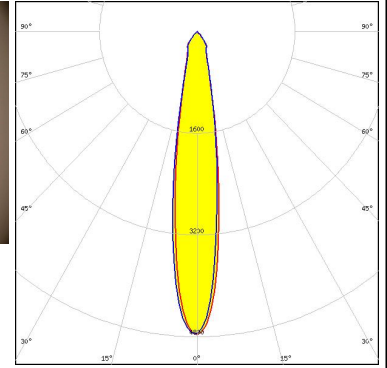
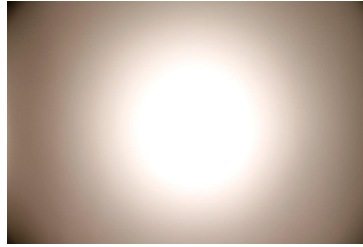

Light distribution files

OPTICAL RESULTS (SIMULATED):



LED LUXEON 7070
FWHM / FWTM 14.0° / 27.0°
Efficiency 96 %
Peak intensity 8.6 cd/lm
LEDs/each optic 1
Light colour/type White
Required components:

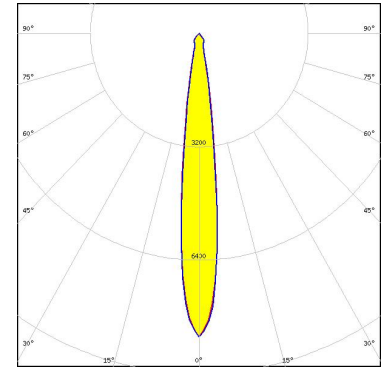

Light distribution files



LED LUXEON V
FWHM / FWTM 7.7° / 17.0°
Efficiency 89 %
Peak intensity 18.7 cd/lm
LEDs/each optic 1
Light colour/type White
Required components:

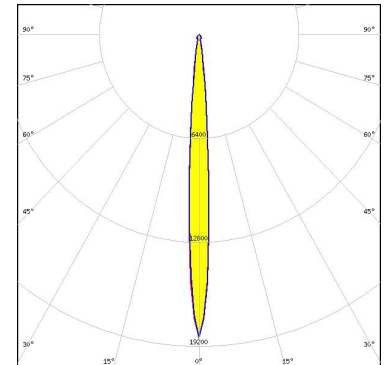

Light distribution files



LED NV4x144A
FWHM / FWTM 12.0° / 22.0°
Efficiency 90 %
Peak intensity 11.1 cd/lm
LEDs/each optic 1
Light colour/type White
Required components:

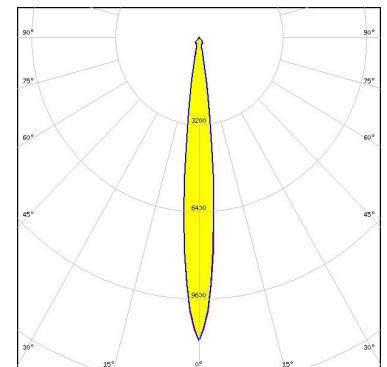

Light distribution files

OPTICAL RESULTS (SIMULATED):

OSRAM
Opto Semiconductors

LED OSCONIQ P 7070
 FWHM / FWTM 11.0° / 21.0°
 Efficiency 91 %
 Peak intensity 12.2 cd/lm
 LEDs/each optic 1
 Light colour/type White
 Required components:

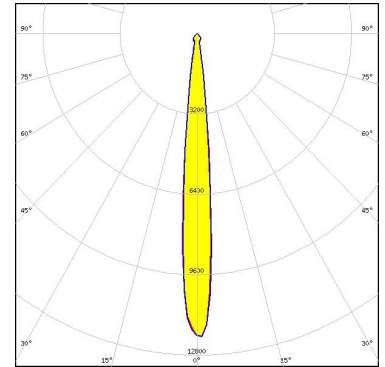

Light distribution files

OSRAM
Opto Semiconductors

LED Soleriq S9
 FWHM / FWTM 21.0° / 55.0°
 Efficiency 86 %
 Peak intensity 3.4 cd/lm
 LEDs/each optic 1
 Light colour/type White
 Required components:
 C12479_MIRELLA-DL

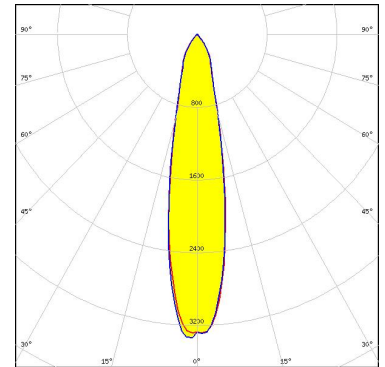

Light distribution files

OSRAM
Opto Semiconductors

LED Soleriq S9
 FWHM / FWTM 19.0° / 44.0°
 Efficiency 91 %
 Peak intensity 4.4 cd/lm
 LEDs/each optic 1
 Light colour/type White
 Required components:

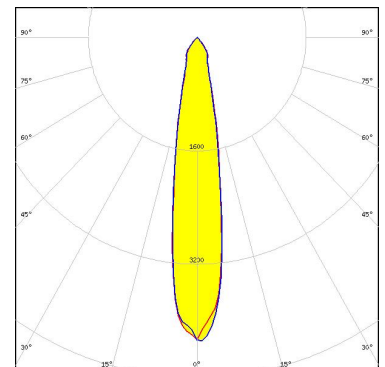

Light distribution files

OPTICAL RESULTS (SIMULATED):

OSRAM
Opto Semiconductors

LED Soleriq S9
FWHM / FWTM 20.0° / 48.0°
Efficiency 87 %
Peak intensity 3.9 cd/lm
LEDs/each optic 1
Light colour/type White
Required components:
C13333_MIRELLA-CL

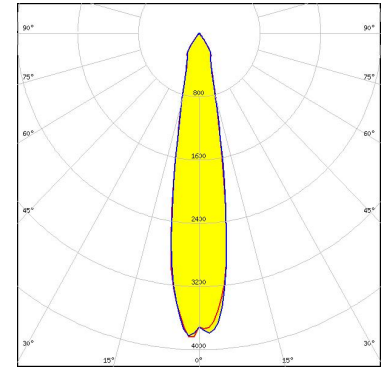

Light distribution files

GENERAL INFORMATION:

NOTE: The typical beam angle will be changed by different color, chip size and chip position tolerance. The typical total beam angle is the full angle measured where the luminous intensity is half of the peak value.

Due to use of high power COB's with this product, special attention to proper thermal design is highly recommended. LEDiL has no liability for direct, indirect or consecutive damages arising from the LEDiL products being used outside of the recommended temperature range.

MATERIALS:

As part of our continuous research and improvement processes, and to ensure the best possible quality and availability of our products, LEDiL reserves the right to change material grades without notice.

PRODUCT DATA USER AGREEMENT AND DISCLAIMER:

The measured data in the provided downloadable LEDiL Product Datasheets and Mechanical 2D-Drawings is rounded and provided as reference for planning. LEDiL Oy's optical specifications have been verified by conducting performance testing of the products in accordance with the company's quality system. The reported data are averaged results of multiple measurements with typical variation. LEDiL Oy reserves the right to without prior notification make changes and improvements to its products.

LEDiL Oy assumes neither warranty, nor guarantee nor any other liability of any kind for the contents and correctness of the provided data. The provided data has been generated with highest diligence but the provided data may in reality not represent the complete possible variation range of all intrinsic parameters. Therefore, in certain cases a deviation from the provided data could occur.

LEDiL Oy reserves the right to undertake technical changes of its products without further notification which could lead to changes in the provided data. LEDiL Oy assumes no liability of any kind for the possible deviation from any provided data or any other damage resulting from the usage of the provided data.

The user agrees to this disclaimer and user agreement with the download or usage of the provided files.

LEDiL Oy

Joensuunkatu 7
FI-24240 SALO
Finland

LEDiL Inc.

228 West Page Street
Suite D
Sycamore IL 60178
USA

Ledil Optics Technology (Shenzhen) Co., Ltd.

405 , Block B
Casic Motor Building
Shenzhen 518057
P.R.CHINA

Local sales and technical support

[www.ledil.com/
where_to_buy](http://www.ledil.com/where_to_buy)

Shipping locations

Poznan, Poland
Hong Kong, China

Distribution Partners

[www.ledil.com/
where_to_buy](http://www.ledil.com/where_to_buy)