

MIRELLA-50-W-PF

~40° wide beam

SPECIFICATION:

Dimensions	Ø 49.9
Height	24 mm
Fastening	socket
ROHS compliant	yes ⓘ

MATERIALS:

Component	Type	Material	Colour	Finish	Coating
MIRELLA-50-W-PF	Reflector	PC	metal		lacquer



ORDERING INFORMATION:

Component	Qty in box	MOQ	MPQ	Box weight (kg)
C13087_MIRELLA-50-W-PF » Box size: 480 x 280 x 300 mm	336	112	28	2.8

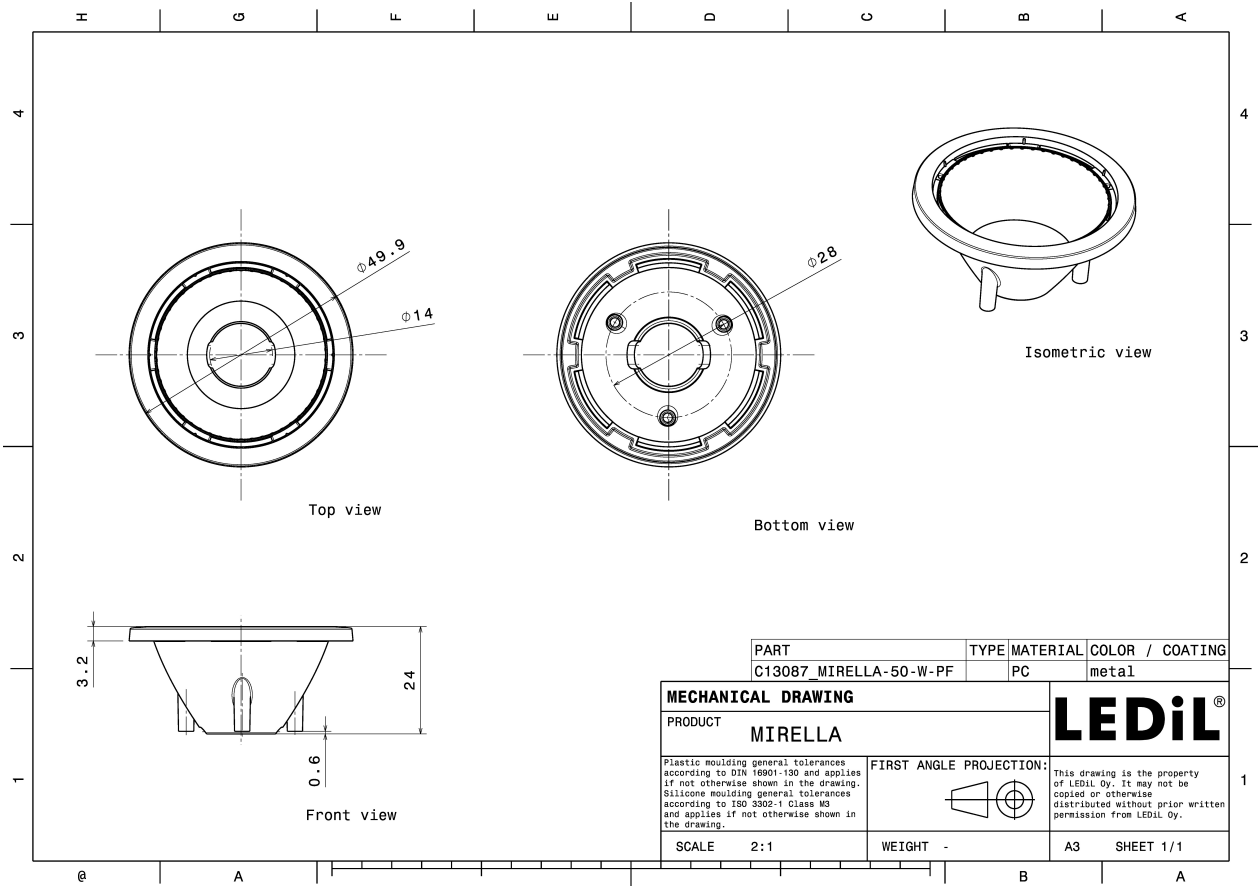

See also our general installation guide: www.ledil.com/installation_guide

OPTICAL RESULTS (MEASURED):

bridgelux

LED V10 Gen6
 FWHM / FWTM 39.0° / 79.0°
 Efficiency 86 %
 Peak intensity 1.5 cd/lm
 LEDs/each optic 1
 Light colour/type White

Required components:

C14115_PF-SOCKET-CXA15-18

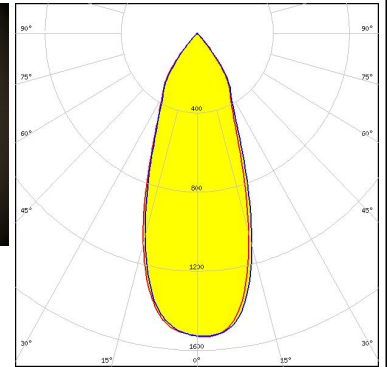
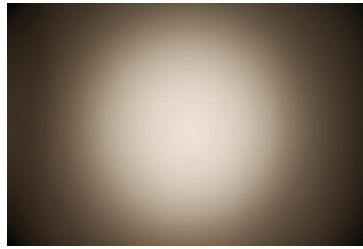

Light distribution files

bridgelux

LED V10 Gen7
 FWHM / FWTM 39.0° / 73.0°
 Efficiency 79 %
 Peak intensity 1.5 cd/lm
 LEDs/each optic 1
 Light colour/type White

Required components:

C13709_PF-SOCKET-VERO13-18

C13333_MIRELLA-CL

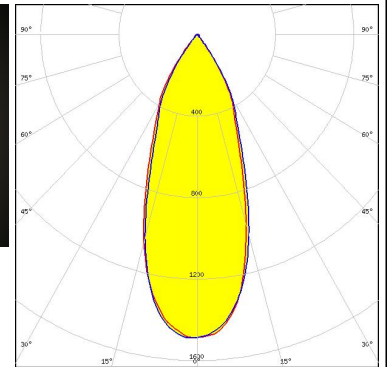
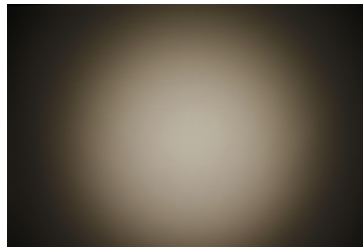

Light distribution files

bridgelux

LED V10 Gen7
 FWHM / FWTM 40.0° / 75.0°
 Efficiency 77 %
 Peak intensity 1.3 cd/lm
 LEDs/each optic 1
 Light colour/type White

Required components:

C13709_PF-SOCKET-VERO13-18

C12479_MIRELLA-DL

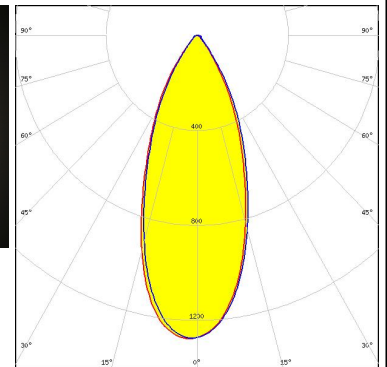
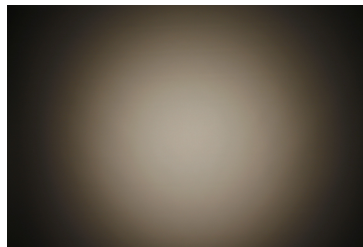

Light distribution files

OPTICAL RESULTS (MEASURED):



LED V10 Gen7
FWHM / FWTM 35.0° / 76.0°
Efficiency 84 %
Peak intensity 1.7 cd/lm
LEDs/each optic 1
Light colour/type White
Required components:
 C13709_PF-SOCKET-VERO13-18

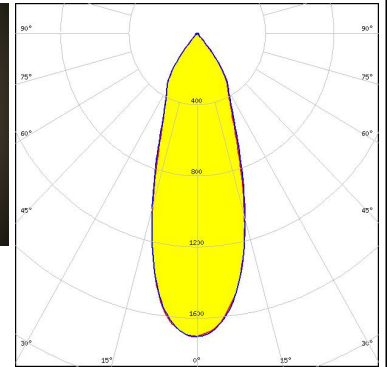

Light distribution files



LED V6 Gen6
FWHM / FWTM 44.0° / 77.0°
Efficiency 81 %
Peak intensity 1.3 cd/lm
LEDs/each optic 1
Light colour/type White
Required components:
 C13761_PF-SOCKET-CXA15
 C13333_MIRELLA-CL

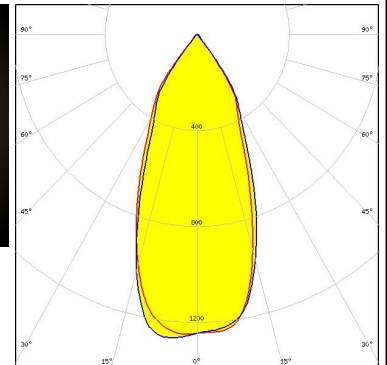
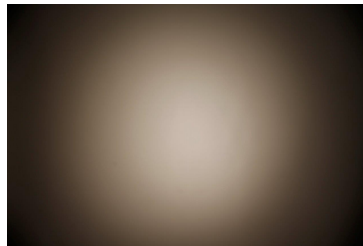

Light distribution files



LED V6 Gen6
FWHM / FWTM 44.0° / 78.0°
Efficiency 81 %
Peak intensity 1.3 cd/lm
LEDs/each optic 1
Light colour/type White
Required components:
 C13761_PF-SOCKET-CXA15
 C12479_MIRELLA-DL

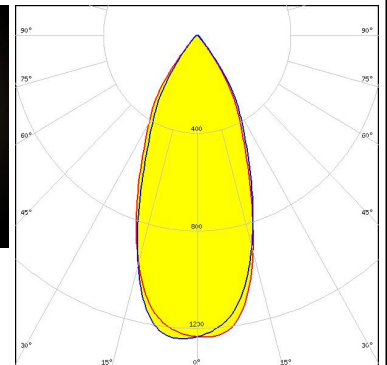
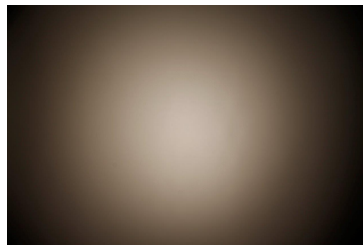

Light distribution files

OPTICAL RESULTS (MEASURED):

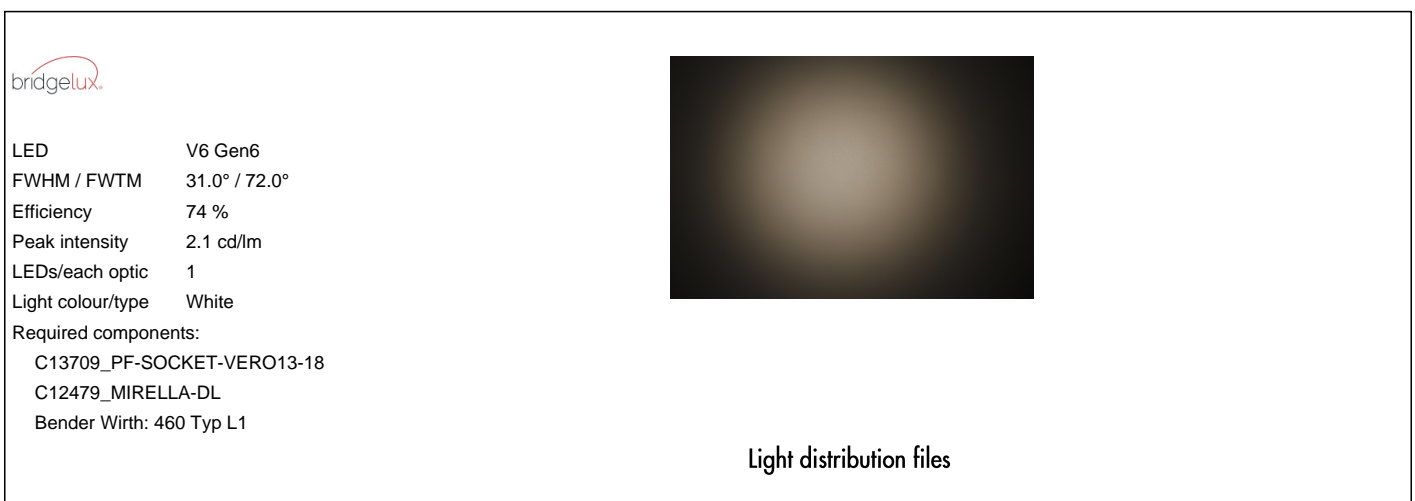
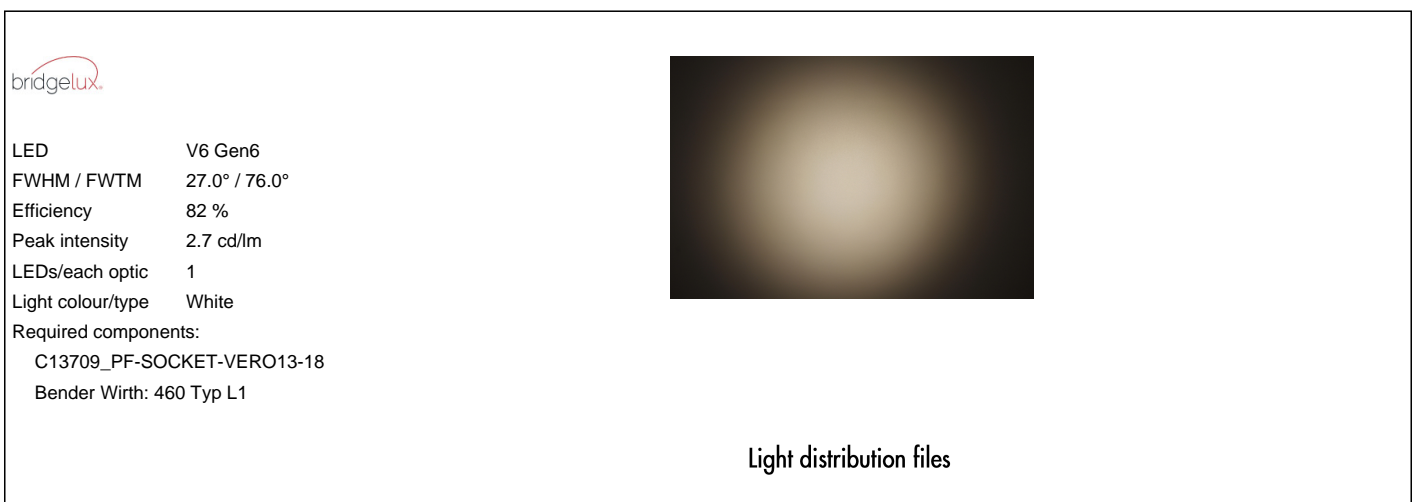
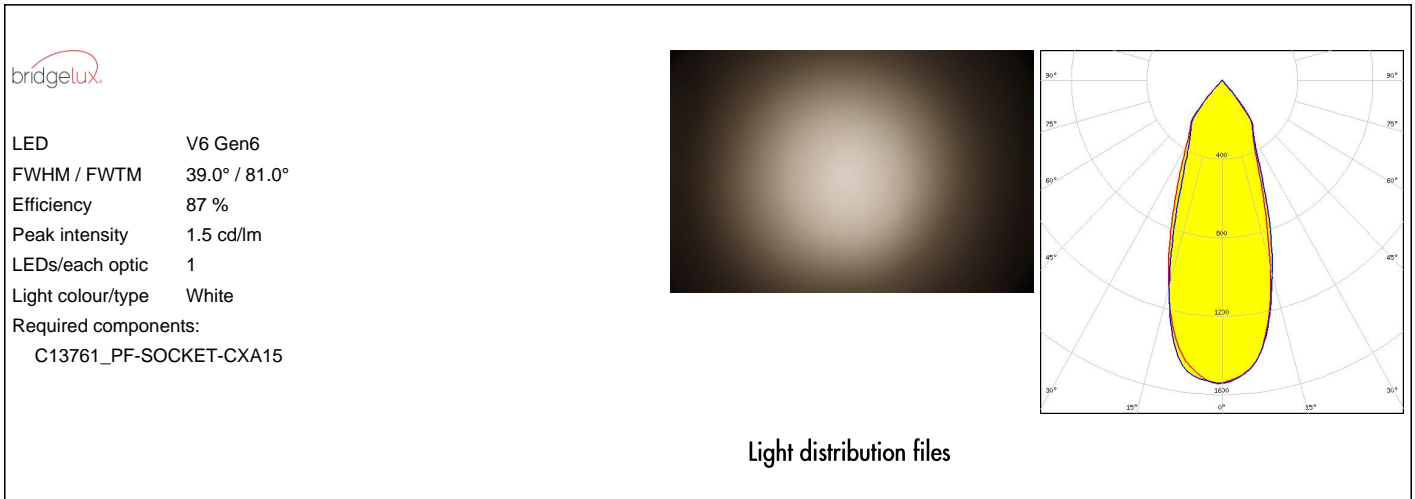

OPTICAL RESULTS (MEASURED):



LED V8 Gen6
FWHM / FWTM 36.0° / 74.0°
Efficiency 73 %
Peak intensity 1.8 cd/lm
LEDs/each optic 1
Light colour/type White

Required components:

C13709_PF-SOCKET-VERO13-18
C12479_MIRELLA-DL
Bender Wirth: 460 Typ L1

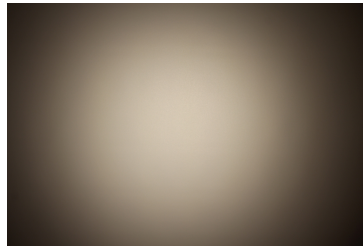

Light distribution files



LED V8 Gen6
FWHM / FWTM 42.0° / 76.0°
Efficiency 82 %
Peak intensity 1.4 cd/lm
LEDs/each optic 1
Light colour/type White

Required components:

C13761_PF-SOCKET-CXA15
C13333_MIRELLA-CL

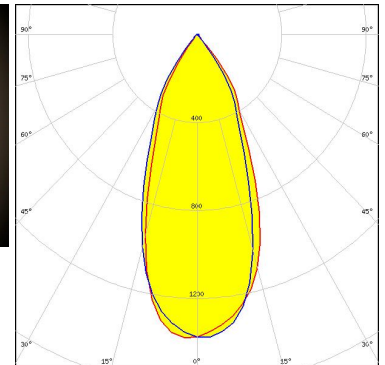
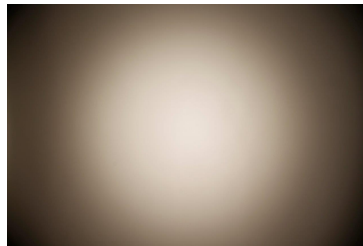

Light distribution files



LED V8 Gen6
FWHM / FWTM 43.0° / 76.0°
Efficiency 82 %
Peak intensity 1.3 cd/lm
LEDs/each optic 1
Light colour/type White

Required components:

C13761_PF-SOCKET-CXA15
C12479_MIRELLA-DL

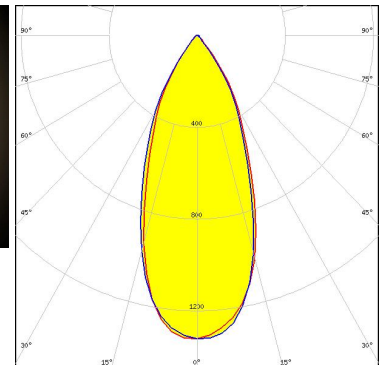
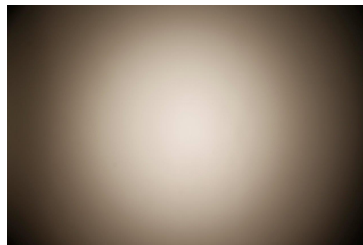

Light distribution files

OPTICAL RESULTS (MEASURED):



LED V8 Gen6
FWHM / FWTM 38.0° / 79.0°
Efficiency 87 %
Peak intensity 1.6 cd/lm
LEDs/each optic 1
Light colour/type White
Required components:
 C13761_PF-SOCKET-CXA15

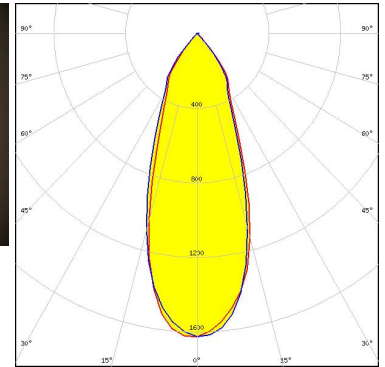
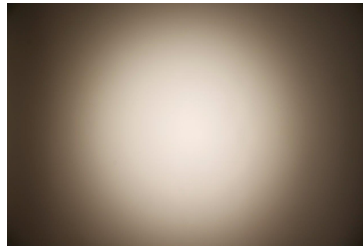

Light distribution files



LED VERO10
FWHM / FWTM 40.0° / 79.0°
Efficiency 85 %
Peak intensity 1.5 cd/lm
LEDs/each optic 1
Light colour/type White
Required components:
 C13708_PF-SOCKET-VERO10

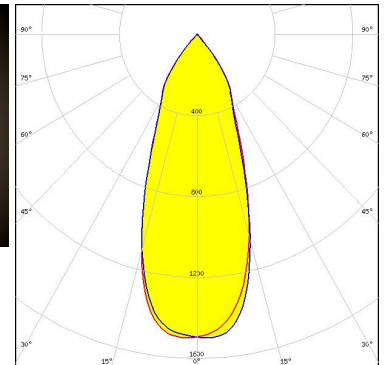
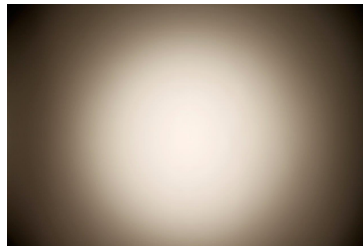

Light distribution files



LED VERO10
FWHM / FWTM 44.0° / 76.0°
Efficiency 80 %
Peak intensity 1.3 cd/lm
LEDs/each optic 1
Light colour/type White
Required components:
 C13708_PF-SOCKET-VERO10
 C13333_MIRELLA-CL



Light distribution files

OPTICAL RESULTS (MEASURED):



LED VERO10
 FWHM / FWTM 44.0° / 76.0°
 Efficiency 80 %
 Peak intensity 1.3 cd/lm
 LEDs/each optic 1
 Light colour/type White

Required components:

C13708_PF-SOCKET-VERO10
 C12479_MIRELLA-DL

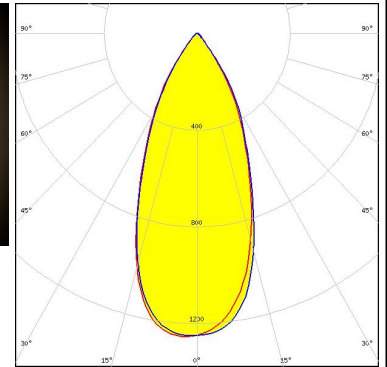
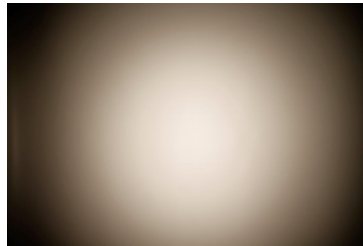

Light distribution files



LED VERO13
 FWHM / FWTM 51.0° / 79.0°
 Efficiency 77 %
 Peak intensity 1.1 cd/lm
 LEDs/each optic 1
 Light colour/type White

Required components:

C13709_PF-SOCKET-VERO13-18
 C13333_MIRELLA-CL

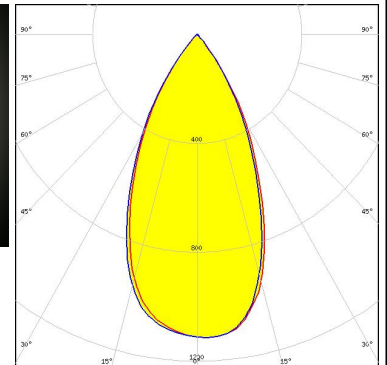
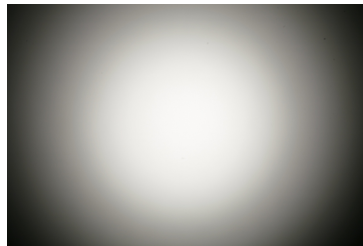

Light distribution files



LED VERO13
 FWHM / FWTM 50.0° / 79.0°
 Efficiency 82 %
 Peak intensity 1.1 cd/lm
 LEDs/each optic 1
 Light colour/type White

Required components:

C13709_PF-SOCKET-VERO13-18
 C12479_MIRELLA-DL

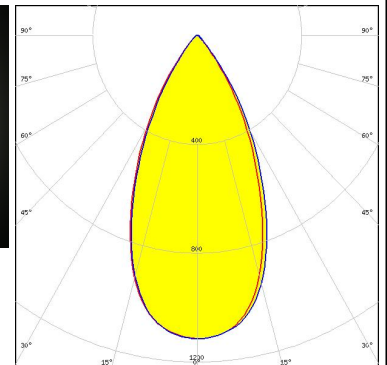
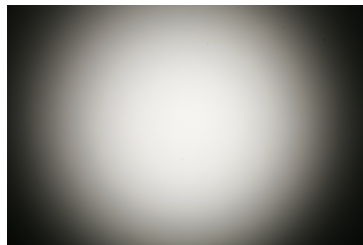

Light distribution files

OPTICAL RESULTS (MEASURED):



LED VERO13
FWHM / FWTM 46.0° / 82.0°
Efficiency 90 %
Peak intensity 1.3 cd/lm
LEDs/each optic 1
Light colour/type White
Required components:
 C13709_PF-SOCKET-VERO13-18

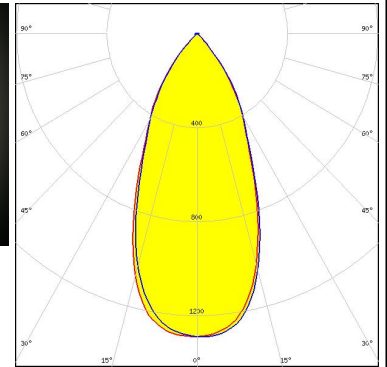

Light distribution files



LED Xenio Point 13mm
FWHM / FWTM 45.0° / 81.0°
Efficiency 85 %
Peak intensity 1.3 cd/lm
LEDs/each optic 1
Light colour/type White
Required components:
 C13709_PF-SOCKET-VERO13-18

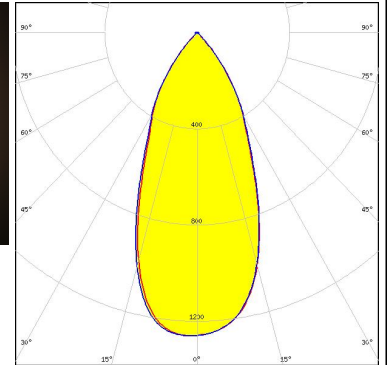

Light distribution files



LED Xenio Point 13mm
FWHM / FWTM 49.0° / 78.0°
Efficiency 81 %
Peak intensity 1.1 cd/lm
LEDs/each optic 1
Light colour/type White
Required components:
 C13709_PF-SOCKET-VERO13-18
 C13333_MIRELLA-CL

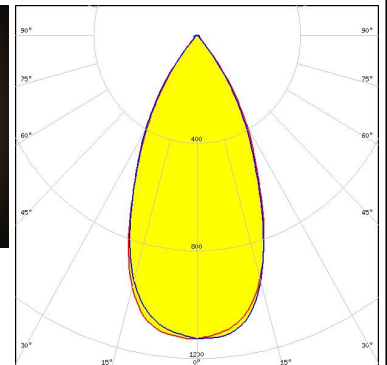
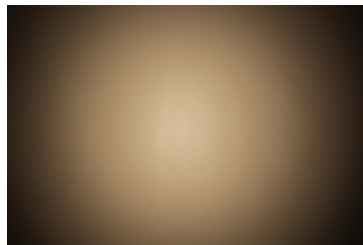

Light distribution files

OPTICAL RESULTS (MEASURED):

bridgelux

LED Xenio Point 13mm
FWHM / FWTM 48.0° / 80.0°
Efficiency 78 %
Peak intensity 1.1 cd/lm
LEDs/each optic 1
Light colour/type White
Required components:
C13709_PF-SOCKET-VERO13-18
C12479_MIRELLA-DL

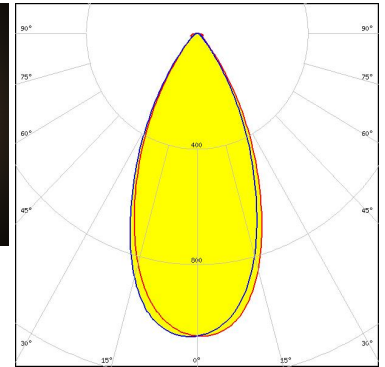
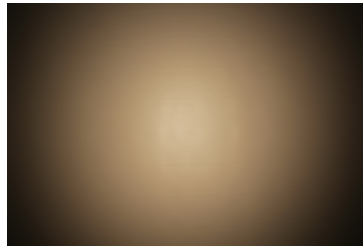

Light distribution files

CITIZEN

LED CLL01x
FWHM / FWTM 36.0° / 80.0°
Efficiency 90 %
Peak intensity 1.8 cd/lm
LEDs/each optic 1
Light colour/type White
Required components:
C13083_PF-SOCKET



Light distribution files

CITIZEN

LED CLL01x
FWHM / FWTM 44.0° / 76.0°
Efficiency 86 %
Peak intensity 1.4 cd/lm
LEDs/each optic 1
Light colour/type White
Required components:
C13083_PF-SOCKET
C12479_MIRELLA-DL

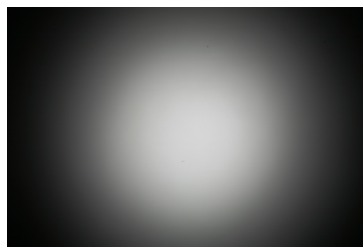

Light distribution files

OPTICAL RESULTS (MEASURED):

CITIZEN

LED CLL01x
FWHM / FWTM 42.0° / 76.0°
Efficiency 86 %
Peak intensity 1.4 cd/lm
LEDs/each optic 1
Light colour/type White

Required components:

C13083_PF-SOCKET
C13333_MIRELLA-CL



Light distribution files

CITIZEN

LED CLL02x/CLU02x (LES10)
FWHM / FWTM 41.0° / 76.0°
Efficiency 76 %
Peak intensity 1.3 cd/lm
LEDs/each optic 1
Light colour/type White

Required components:

C13709_PF-SOCKET-VERO13-18
C12479_MIRELLA-DL
Bender Wirth: 434 Typ L1

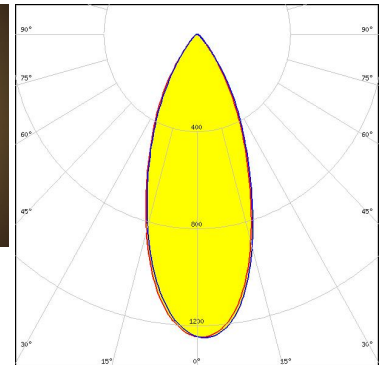
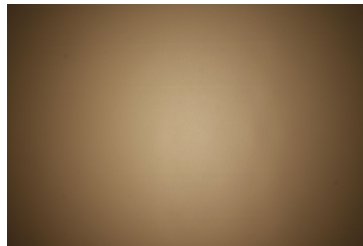

Light distribution files

CITIZEN

LED CLL02x/CLU02x (LES10)
FWHM / FWTM 46.0° / 77.0°
Efficiency 86 %
Peak intensity 1.5 cd/lm
LEDs/each optic 1
Light colour/type White

Required components:

C13083_PF-SOCKET
C12479_MIRELLA-DL

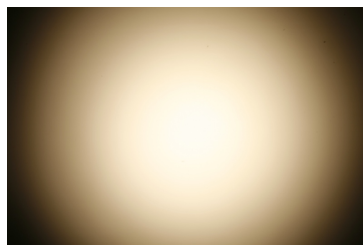

Light distribution files

OPTICAL RESULTS (MEASURED):

CITIZEN

LED CLL02x/CLU02x (LES10)
FWHM / FWTM 46.0° / 80.0°
Efficiency %
Peak intensity 0.7 cd/lm
LEDs/each optic 1
Light colour/type White
Required components:
C13083_PF-SOCKET
C13723_MIRELLA-RZL

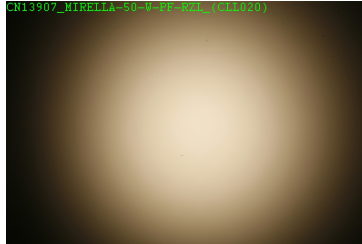

CITIZEN

LED CLL02x/CLU02x (LES10)
FWHM / FWTM 46.0° / 78.0°
Efficiency 86 %
Peak intensity 1.5 cd/lm
LEDs/each optic 1
Light colour/type White
Required components:
C13083_PF-SOCKET
C13333_MIRELLA-CL

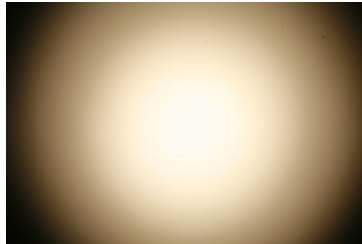

Light distribution files

CITIZEN

LED CLL02x/CLU02x (LES10)
FWHM / FWTM 41.0° / 80.0°
Efficiency 90 %
Peak intensity 1.8 cd/lm
LEDs/each optic 1
Light colour/type White
Required components:
C13083_PF-SOCKET

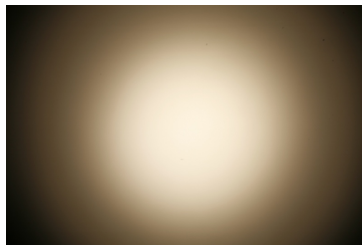

Light distribution files

OPTICAL RESULTS (MEASURED):

CITIZEN

LED CLL02x/CLU02x (LES10)
FWHM / FWTM 36.0° / 77.0°
Efficiency 84 %
Peak intensity 1.7 cd/lm
LEDs/each optic 1
Light colour/type White
Required components:
C13709_PF-SOCKET-VERO13-18
Bender Wirth: 434 Typ L1

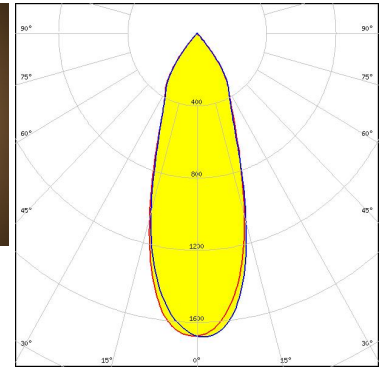
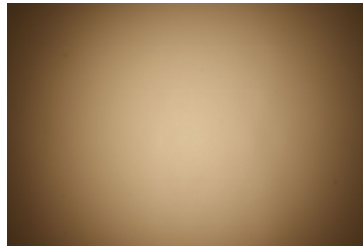

Light distribution files

CITIZEN

LED CLL02x/CLU02x (LES10)
FWHM / FWTM 39.0° / 73.0°
Efficiency 78 %
Peak intensity 1.5 cd/lm
LEDs/each optic 1
Light colour/type White
Required components:
C13709_PF-SOCKET-VERO13-18
C13333_MIRELLA-CL
Bender Wirth: 434 Typ L1

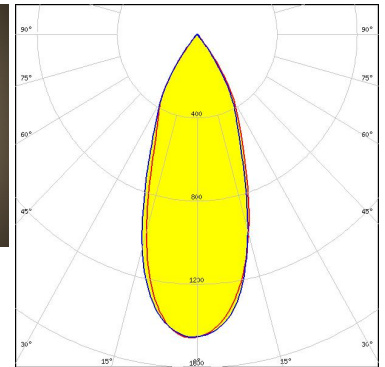
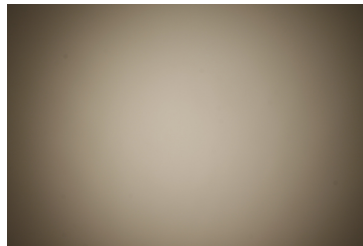

Light distribution files

CITIZEN

LED CLU700/701/702/703
FWHM / FWTM 34.0° / 72.0°
Efficiency 81 %
Peak intensity 1.8 cd/lm
LEDs/each optic 1
Light colour/type White
Required components:
C13083_PF-SOCKET
C13333_MIRELLA-CL

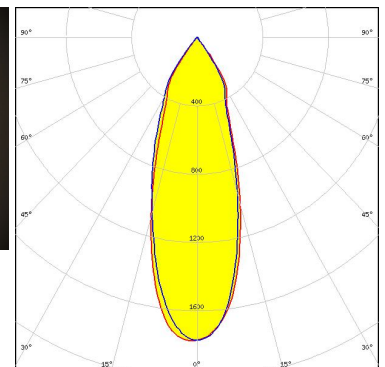
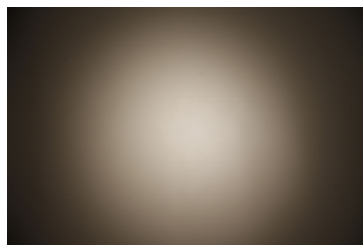

Light distribution files

OPTICAL RESULTS (MEASURED):

CITIZEN

LED CLU700/701/702/703
 FWHM / FWTM 26.0° / 73.0°
 Efficiency 83 %
 Peak intensity 2.4 cd/lm
 LEDs/each optic 1
 Light colour/type White
 Required components:
 C13709_PF-SOCKET-VERO13-18
 Bender Wirth: 434 Typ L1

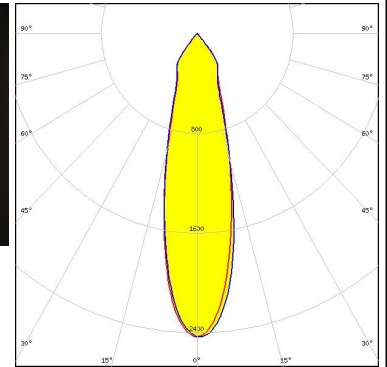
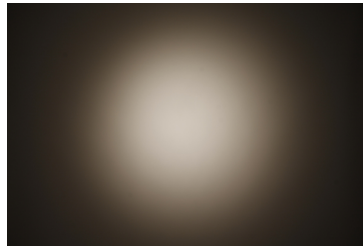

Light distribution files

CITIZEN

LED CLU700/701/702/703
 FWHM / FWTM 29.0° / 69.0°
 Efficiency 80 %
 Peak intensity 2.1 cd/lm
 LEDs/each optic 1
 Light colour/type White
 Required components:
 C13709_PF-SOCKET-VERO13-18
 C13333_MIRELLA-CL
 Bender Wirth: 434 Typ L1

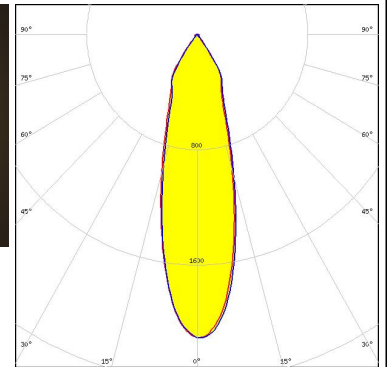
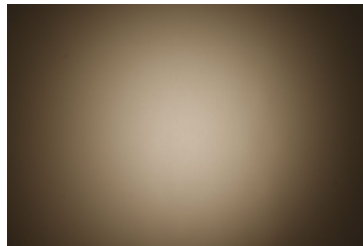

Light distribution files

CITIZEN

LED CLU700/701/702/703
 FWHM / FWTM 33.0° / 78.0°
 Efficiency 88 %
 Peak intensity 1.9 cd/lm
 LEDs/each optic 1
 Light colour/type White
 Required components:
 C13083_PF-SOCKET

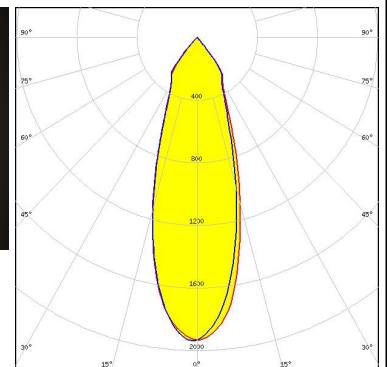
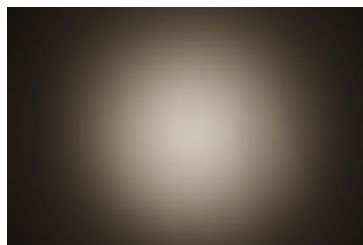

Light distribution files

OPTICAL RESULTS (MEASURED):

CITIZEN

LED CLU700/701/702/703
 FWHM / FWTM 31.0° / 70.0°
 Efficiency 77 %
 Peak intensity 1.8 cd/lm
 LEDs/each optic 1
 Light colour/type White
 Required components:
 C13709_PF-SOCKET-VERO13-18
 C12479_MIRELLA-DL
 Bender Wirth: 434 Typ L1

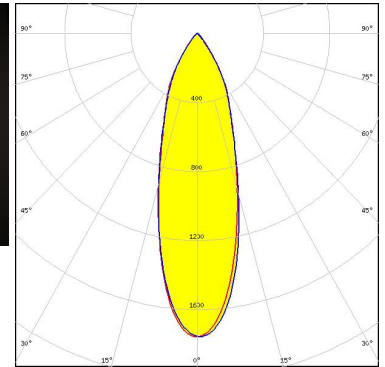

Light distribution files

CITIZEN

LED CLU700/701/702/703
 FWHM / FWTM 39.0° / 75.0°
 Efficiency 82 %
 Peak intensity 1.4 cd/lm
 LEDs/each optic 1
 Light colour/type White
 Required components:
 C13083_PF-SOCKET
 C12479_MIRELLA-DL

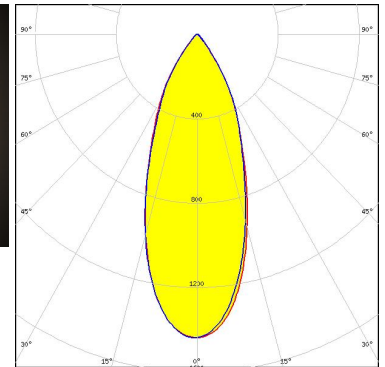
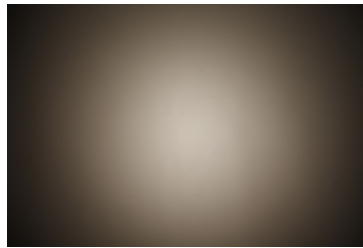

Light distribution files

CITIZEN

LED CLU700/701/702/703
 FWHM / FWTM 42.0° / 78.0°
 Efficiency 81 %
 Peak intensity 1.3 cd/lm
 LEDs/each optic 1
 Light colour/type White
 Required components:
 C13083_PF-SOCKET
 C13723_MIRELLA-RZL

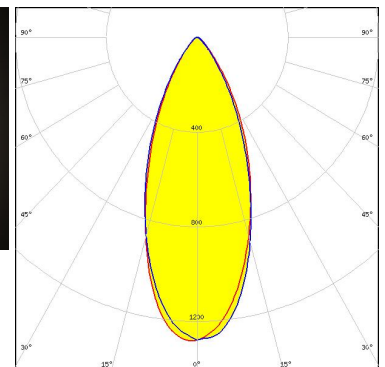
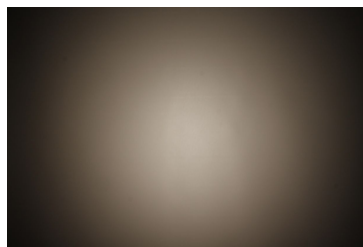

Light distribution files

OPTICAL RESULTS (MEASURED):

CITIZEN

LED CLU720/721/723
 FWHM / FWTM 40.0° / 78.0°
 Efficiency 81 %
 Peak intensity 1.4 cd/lm
 LEDs/each optic 1
 Light colour/type White
 Required components:
 C13709_PF-SOCKET-VERO13-18
 Bender Wirth: 433 Typ L1

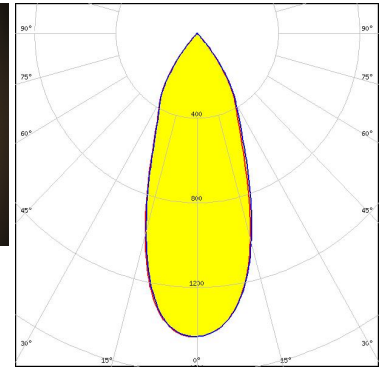
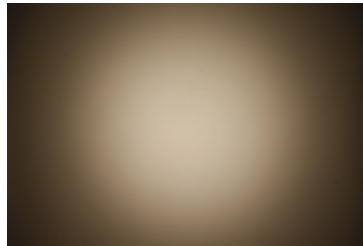

Light distribution files

CITIZEN

LED CLU720/721/723
 FWHM / FWTM 44.0° / 78.0°
 Efficiency 74 %
 Peak intensity 1.1 cd/lm
 LEDs/each optic 1
 Light colour/type White
 Required components:
 C13709_PF-SOCKET-VERO13-18
 C12479_MIRELLA-DL
 Bender Wirth: 433 Typ L1

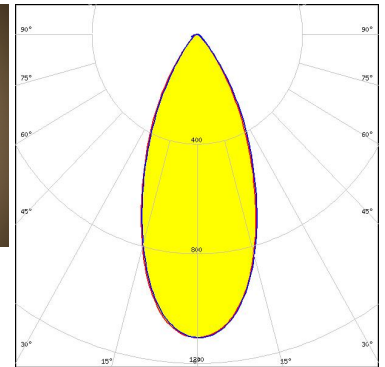
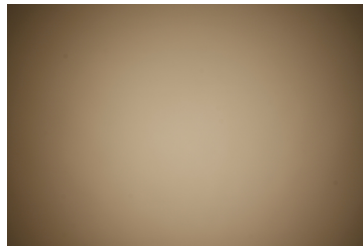

Light distribution files

CITIZEN

LED CLU720/721/723
 FWHM / FWTM 43.0° / 74.0°
 Efficiency 76 %
 Peak intensity 1.3 cd/lm
 LEDs/each optic 1
 Light colour/type White
 Required components:
 C13709_PF-SOCKET-VERO13-18
 C13333_MIRELLA-CL
 Bender Wirth: 433 Typ L1

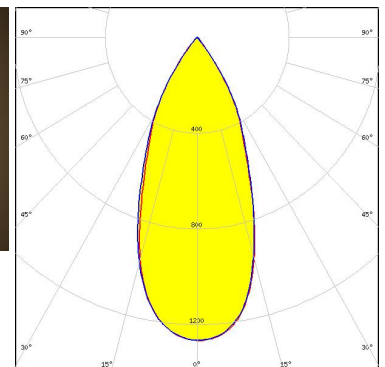
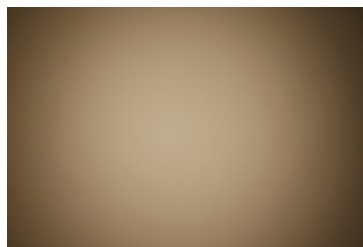

Light distribution files

OPTICAL RESULTS (MEASURED):



LED CXA/B 13xx
 FWHM / FWTM 42.0° / 76.0°
 Efficiency 81 %
 Peak intensity 1.5 cd/lm
 LEDs/each optic 1
 Light colour/type White

Required components:

C13761_PF-SOCKET-CXA15
 C13333_MIRELLA-CL



Light distribution files



LED CXA/B 13xx
 FWHM / FWTM 43.0° / 76.0°
 Efficiency 81 %
 Peak intensity 1.4 cd/lm
 LEDs/each optic 1
 Light colour/type White

Required components:

C13761_PF-SOCKET-CXA15
 C12479_MIRELLA-DL

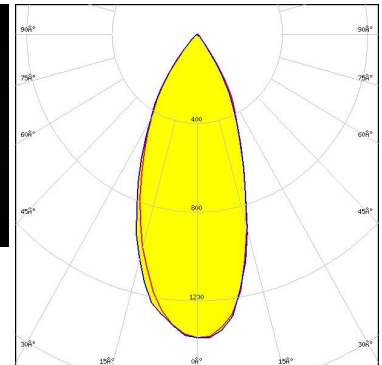
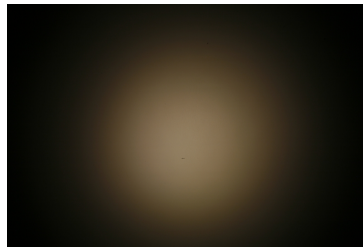

Light distribution files



LED CXA/B 13xx
 FWHM / FWTM 37.0° / 80.0°
 Efficiency 86 %
 Peak intensity 1.8 cd/lm
 LEDs/each optic 1
 Light colour/type White

Required components:

C13761_PF-SOCKET-CXA15

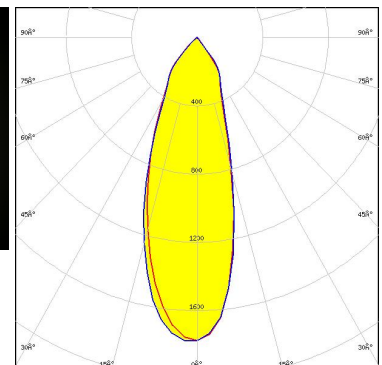
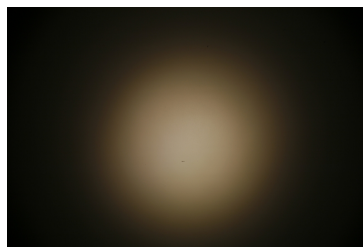

Light distribution files

OPTICAL RESULTS (MEASURED):



LED CXA/B 15xx
 FWHM / FWTM 41.0° / 82.0°
 Efficiency 90 %
 Peak intensity 1.4 cd/lm
 LEDs/each optic 1
 Light colour/type White
 Required components:
 C13761_PF-SOCKET-CXA15

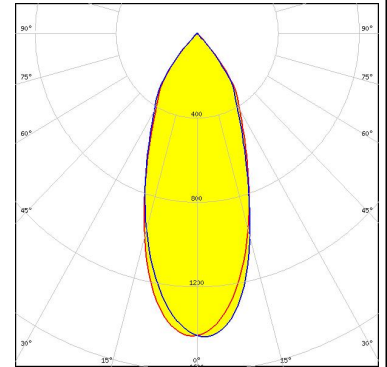

Light distribution files



LED CXA/B 15xx
 FWHM / FWTM 34.0° / 75.0°
 Efficiency 82 %
 Peak intensity 1.8 cd/lm
 LEDs/each optic 1
 Light colour/type White
 Required components:
 C13709_PF-SOCKET-VERO13-18
 Bender Wirth: 441 Typ L1

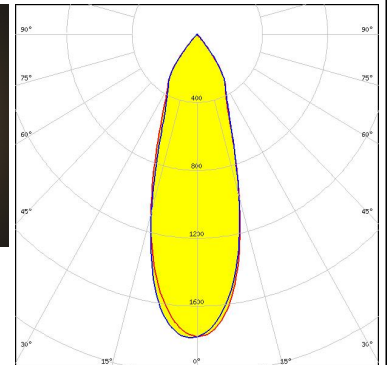
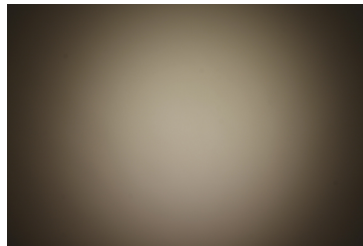

Light distribution files



LED CXA/B 15xx
 FWHM / FWTM 47.0° / 81.0°
 Efficiency 81 %
 Peak intensity 1.2 cd/lm
 LEDs/each optic 1
 Light colour/type White
 Required components:
 C13761_PF-SOCKET-CXA15
 C13723_MIRELLA-RZL

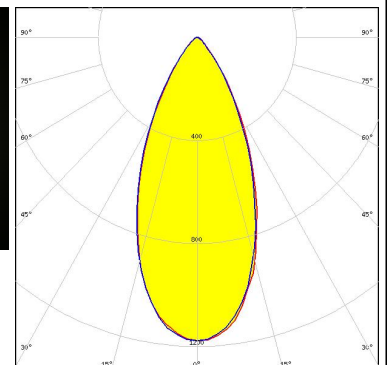
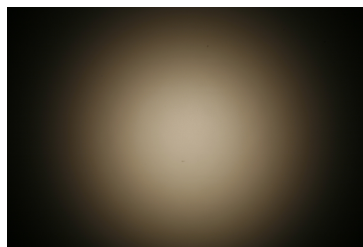

Light distribution files

OPTICAL RESULTS (MEASURED):



LED CXA/B 15xx
 FWHM / FWTM 39.0° / 75.0°
 Efficiency 75 %
 Peak intensity 1.3 cd/lm
 LEDs/each optic 1
 Light colour/type White

Required components:

C13709_PF-SOCKET-VERO13-18
 C12479_MIRELLA-DL
 Bender Wirth: 441 Typ L1

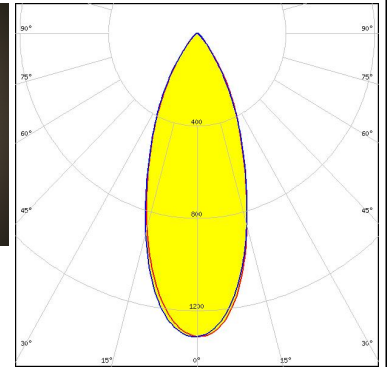
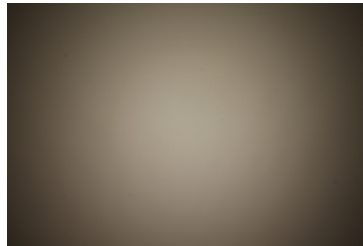

Light distribution files



LED CXA/B 15xx
 FWHM / FWTM 46.0° / 79.0°
 Efficiency 85 %
 Peak intensity 1.4 cd/lm
 LEDs/each optic 1
 Light colour/type White

Required components:

C13761_PF-SOCKET-CXA15
 C13333_MIRELLA-CL

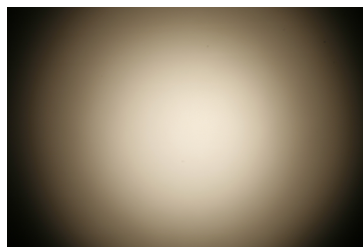

Light distribution files



LED CXA/B 15xx
 FWHM / FWTM 37.0° / 72.0°
 Efficiency 79 %
 Peak intensity 1.6 cd/lm
 LEDs/each optic 1
 Light colour/type White

Required components:

C13709_PF-SOCKET-VERO13-18
 C13333_MIRELLA-CL
 Bender Wirth: 441 Typ L1

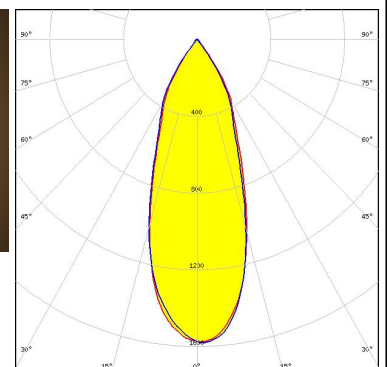
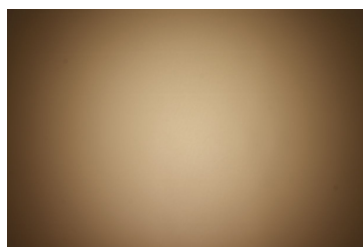

Light distribution files

OPTICAL RESULTS (MEASURED):



LED CXA/B 15xx
FWHM / FWTM 47.0° / 79.0°
Efficiency 85 %
Peak intensity 1.2 cd/lm
LEDs/each optic 1
Light colour/type White
Required components:
C13761_PF-SOCKET-CXA15
C12479_MIRELLA-DL

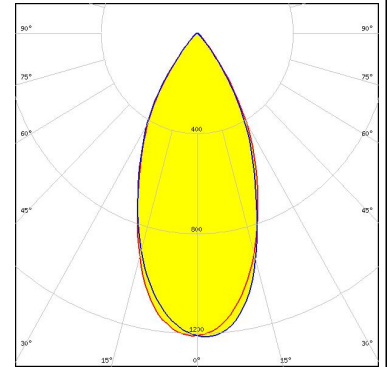

Light distribution files



LED CXA/B 1816 & CXA/B 1820 & CXA 1850
FWHM / FWTM 43.0° / 81.0°
Efficiency 87 %
Peak intensity 1.4 cd/lm
LEDs/each optic 1
Light colour/type White
Required components:
IDEAL: 50-2101CR + 50-2100MR

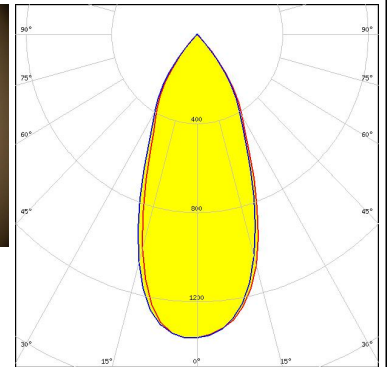
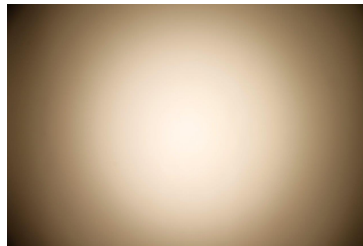

Light distribution files



LED CXA/B 1816 & CXA/B 1820 & CXA 1850
FWHM / FWTM 45.0° / 81.0°
Efficiency 84 %
Peak intensity 1.3 cd/lm
LEDs/each optic 1
Light colour/type White
Required components:
C14115_PF-SOCKET-CXA15-18

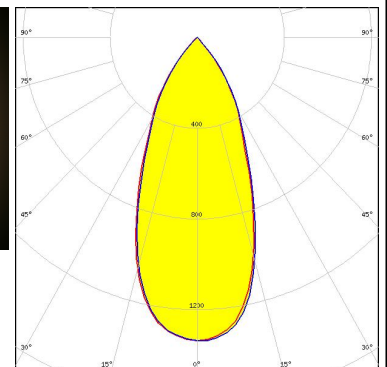
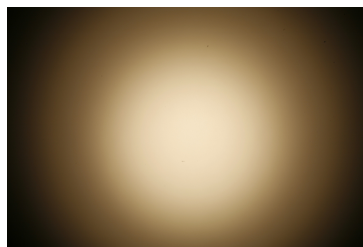

Light distribution files

OPTICAL RESULTS (MEASURED):



LED MHD-E/G
 FWHM / FWTM 45.0° / 78.0°
 Efficiency 84 %
 Peak intensity 1.2 cd/lm
 LEDs/each optic 1
 Light colour/type White
 Required components:
 C13083_PF-SOCKET
 C12479_MIRELLA-DL

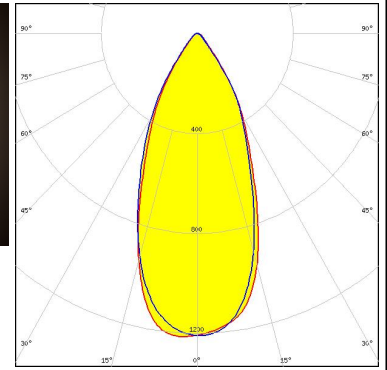

Light distribution files



LED MHD-E/G
 FWHM / FWTM 45.0° / 83.0°
 Efficiency 82 %
 Peak intensity 1.1 cd/lm
 LEDs/each optic 1
 Light colour/type White
 Required components:
 C13083_PF-SOCKET
 C13723_MIRELLA-RZL

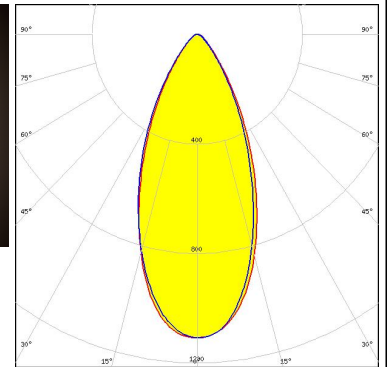
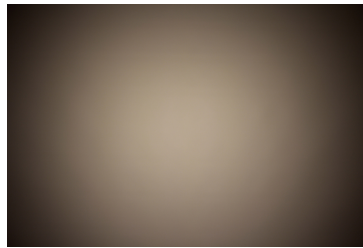

Light distribution files



LED MHD-E/G
 FWHM / FWTM 44.0° / 77.0°
 Efficiency 84 %
 Peak intensity 1.3 cd/lm
 LEDs/each optic 1
 Light colour/type White
 Required components:
 C13083_PF-SOCKET
 C13333_MIRELLA-CL

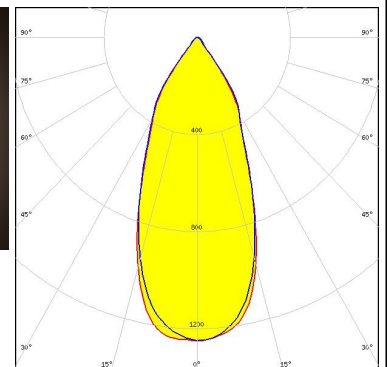
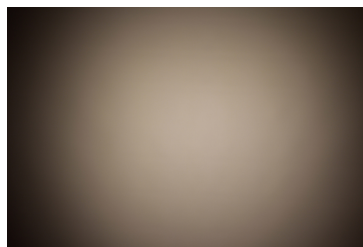

Light distribution files

OPTICAL RESULTS (MEASURED):



LED MHD-E/G
 FWHM / FWTM 38.0° / 82.0°
 Efficiency 89 %
 Peak intensity 1.5 cd/lm
 LEDs/each optic 1
 Light colour/type White
 Required components:
 C13083_PF-SOCKET

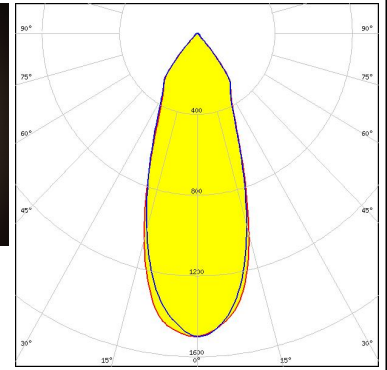

Light distribution files



LED MK-R
 FWHM / FWTM 30.0° / 77.0°
 Efficiency 85 %
 Peak intensity 2.1 cd/lm
 LEDs/each optic 1
 Light colour/type White
 Required components:
 C13083_PF-SOCKET

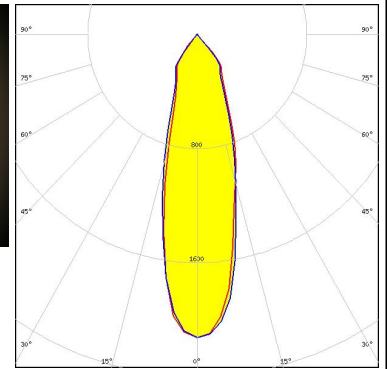

Light distribution files



LED MK-R
 FWHM / FWTM 34.0° / 73.0°
 Efficiency 80 %
 Peak intensity 1.7 cd/lm
 LEDs/each optic 1
 Light colour/type White
 Required components:
 C13083_PF-SOCKET
 C12479_MIRELLA-DL

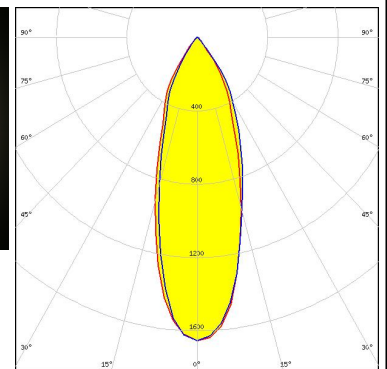
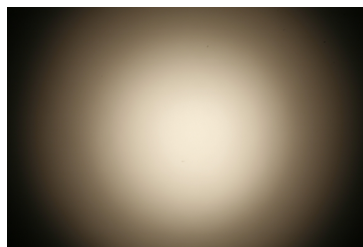

Light distribution files

OPTICAL RESULTS (MEASURED):



LED MT-G
FWHM / FWTM 48.0° / 87.0°
Efficiency 90 %
Peak intensity 1.4 cd/lm
LEDs/each optic 1
Light colour/type White

Required components:

C13083_PF-SOCKET

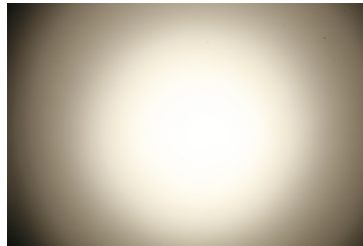

Light distribution files



LED MT-G
FWHM / FWTM 52.0° / 84.0°
Efficiency 86 %
Peak intensity 1.2 cd/lm
LEDs/each optic 1
Light colour/type White

Required components:

C13083_PF-SOCKET

C12479_MIRELLA-DL

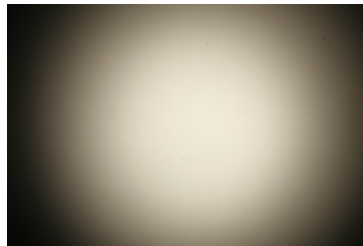

Light distribution files



LED MT-G
FWHM / FWTM 52.0° / 83.0°
Efficiency 86 %
Peak intensity 1.2 cd/lm
LEDs/each optic 1
Light colour/type White

Required components:

C13083_PF-SOCKET

C13333_MIRELLA-CL

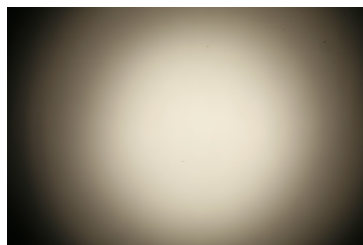

Light distribution files

OPTICAL RESULTS (MEASURED):



LED MT-G2
FWHM / FWTM 50.0° / 81.0°
Efficiency 87 %
Peak intensity 1.2 cd/lm
LEDs/each optic 1
Light colour/type White

Required components:
C13083_PF-SOCKET
C13333_MIRELLA-CL

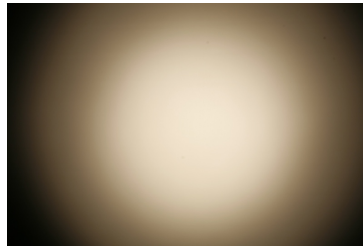

Light distribution files



LED MT-G2
FWHM / FWTM 46.0° / 86.0°
Efficiency 91 %
Peak intensity 0.8 cd/lm
LEDs/each optic 1
Light colour/type White

Required components:
C13083_PF-SOCKET

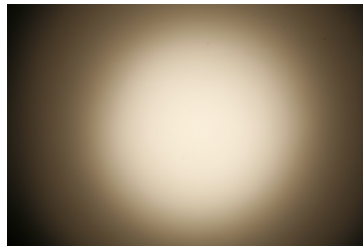

Light distribution files



LED MT-G2
FWHM / FWTM 51.0° / 82.0°
Efficiency 87 %
Peak intensity 1.2 cd/lm
LEDs/each optic 1
Light colour/type White

Required components:
C13083_PF-SOCKET
C12479_MIRELLA-DL

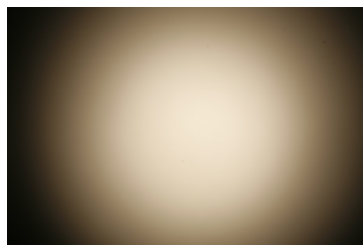

Light distribution files

OPTICAL RESULTS (MEASURED):



LED XHP50
FWHM / FWTM 38.0° / 77.0°
Efficiency 80 %
Peak intensity 1.3 cd/lm
LEDs/each optic 1
Light colour/type White
Required components:
 C13083_PF-SOCKET
 C13723_MIRELLA-RZL

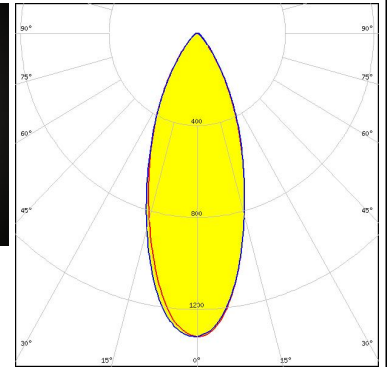
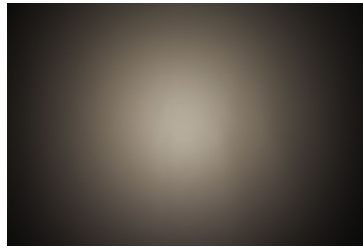

Light distribution files



LED XHP50
FWHM / FWTM 39.0° / 76.0°
Efficiency 82 %
Peak intensity 1.4 cd/lm
LEDs/each optic 1
Light colour/type White
Required components:
 C13083_PF-SOCKET
 C12479_MIRELLA-DL

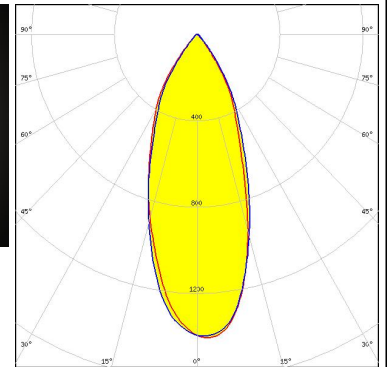
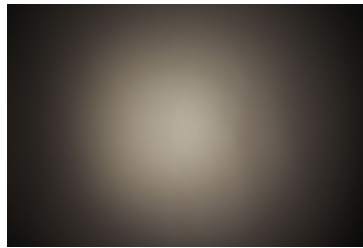

Light distribution files



LED XHP50
FWHM / FWTM 33.0° / 80.0°
Efficiency 87 %
Peak intensity 1.8 cd/lm
LEDs/each optic 1
Light colour/type White
Required components:
 C13083_PF-SOCKET

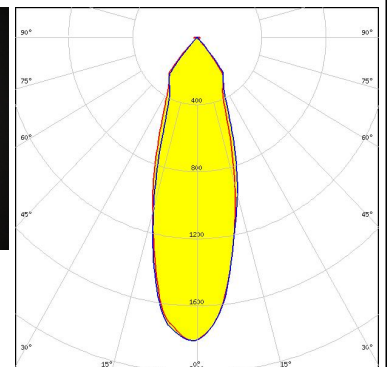
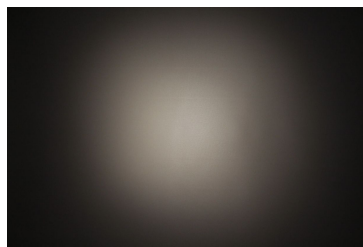

Light distribution files

OPTICAL RESULTS (MEASURED):



LED XHP50
FWHM / FWTM 39.0° / 76.0°
Efficiency 81 %
Peak intensity 1.5 cd/lm
LEDs/each optic 1
Light colour/type White
Required components:
 C13083_PF-SOCKET
 C13333_MIRELLA-CL

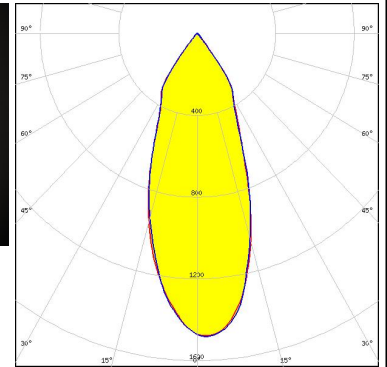
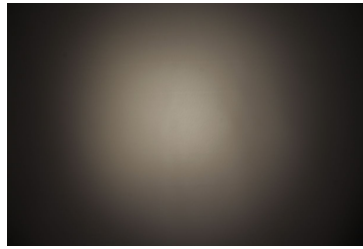

Light distribution files



LED XHP70
FWHM / FWTM 43.0° / 77.0°
Efficiency 81 %
Peak intensity 1.3 cd/lm
LEDs/each optic 1
Light colour/type White
Required components:
 C13083_PF-SOCKET
 C12479_MIRELLA-DL

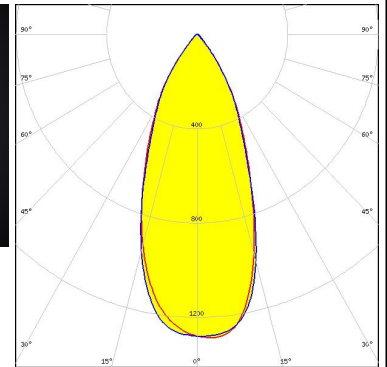
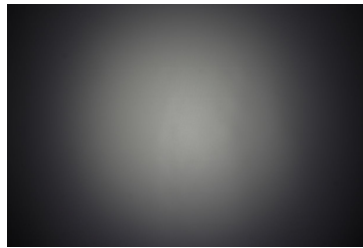

Light distribution files



LED XHP70
FWHM / FWTM 39.0° / 82.0°
Efficiency 86 %
Peak intensity 1.5 cd/lm
LEDs/each optic 1
Light colour/type White
Required components:
 C13083_PF-SOCKET

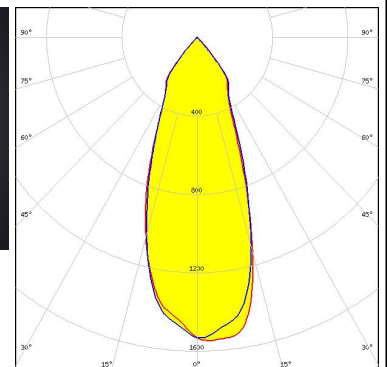
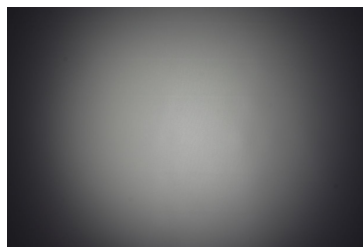

Light distribution files

OPTICAL RESULTS (MEASURED):



LED XHP70
 FWHM / FWTM 44.0° / 80.0°
 Efficiency 79 %
 Peak intensity 1.2 cd/lm
 LEDs/each optic 1
 Light colour/type White
 Required components:
 C13083_PF-SOCKET
 C13723_MIRELLA-RZL

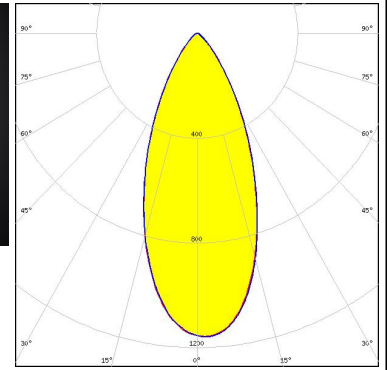
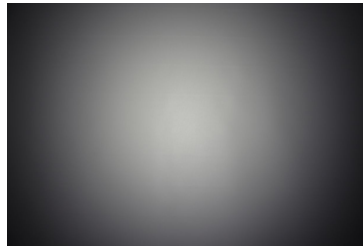

Light distribution files



LED XHP70
 FWHM / FWTM 42.0° / 77.0°
 Efficiency 81 %
 Peak intensity 1.3 cd/lm
 LEDs/each optic 1
 Light colour/type White
 Required components:
 C13083_PF-SOCKET
 C13333_MIRELLA-CL

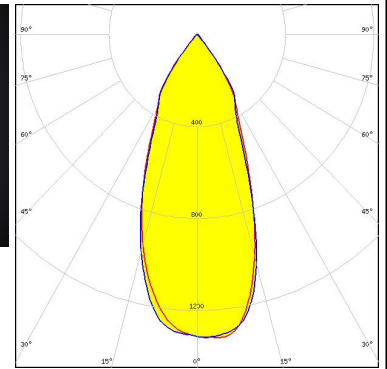
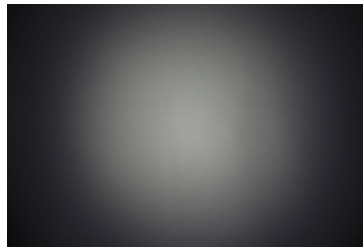

Light distribution files



LED XM-L RGBW (XMLCTW)
 FWHM / FWTM 41.0° / 80.0°
 Efficiency 80 %
 Peak intensity 1.3 cd/lm
 LEDs/each optic 1
 Light colour/type White
 Required components:
 C13083_PF-SOCKET
 C13723_MIRELLA-RZL

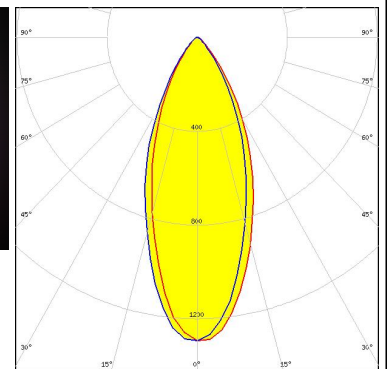
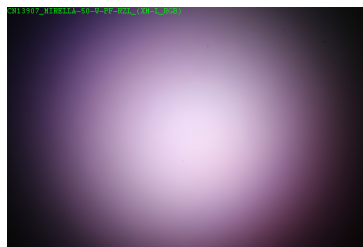

Light distribution files

OPTICAL RESULTS (MEASURED):



LED XQ-E HI
FWHM / FWTM 42.0° / 82.0°
Efficiency 87 %
Peak intensity 1.4 cd/lm
LEDs/each optic 4
Light colour/type RGBW
Required components:
C13083_PF-SOCKET
C13723_MIRELLA-RZL

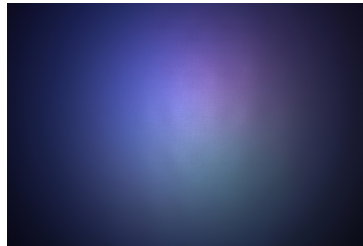

Light distribution files



LED LUXEON CoB 1202/1203
FWHM / FWTM 41.0° / 75.0°
Efficiency 81 %
Peak intensity 1.4 cd/lm
LEDs/each optic 1
Light colour/type White
Required components:
C12479_MIRELLA-DL
IDEAL: 50-2100NC +50-2100MR

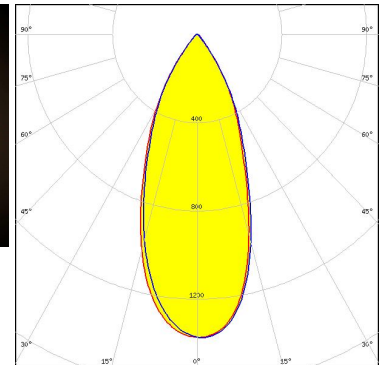
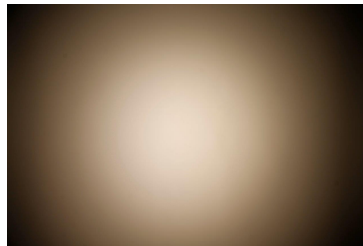

Light distribution files



LED LUXEON CoB 1202/1203
FWHM / FWTM 39.0° / 79.0°
Efficiency 86 %
Peak intensity 1.6 cd/lm
LEDs/each optic 1
Light colour/type White
Required components:
C14037_PF-NSX-SOCKET

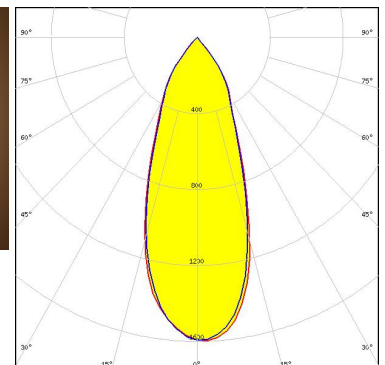
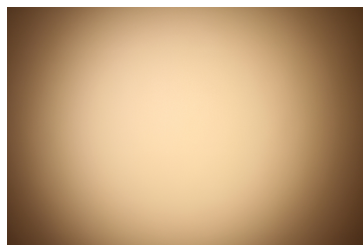

Light distribution files

OPTICAL RESULTS (MEASURED):



LED LUXEON CoB 1202/1203
FWHM / FWTM 37.0° / 78.0°
Efficiency 87 %
Peak intensity 1.7 cd/lm
LEDs/each optic 1
Light colour/type White
Required components:
IDEAL: 50-2100NC +50-2100MR

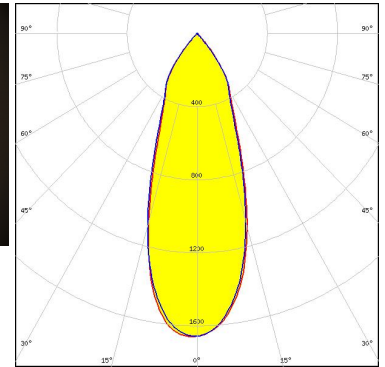
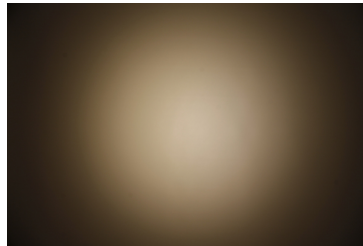

Light distribution files



LED LUXEON CoB 1202/1203
FWHM / FWTM 35.0° / 76.0°
Efficiency 83 %
Peak intensity 1.7 cd/lm
LEDs/each optic 1
Light colour/type White
Required components:
C13709_PF-SOCKET-VERO13-18
Bender Wirth: 438 Typ L1

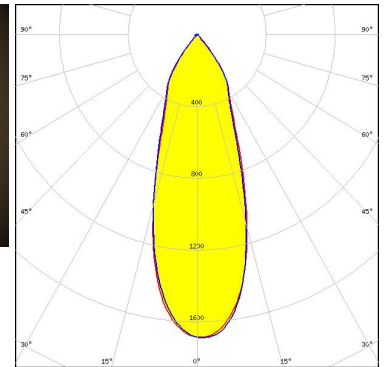
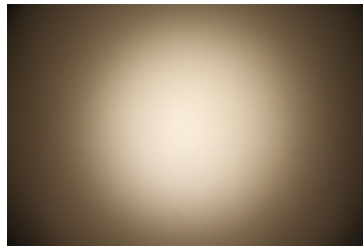

Light distribution files



LED LUXEON CoB 1202/1203
FWHM / FWTM 40.0° / 75.0°
Efficiency 75 %
Peak intensity 1.3 cd/lm
LEDs/each optic 1
Light colour/type White
Required components:
C13709_PF-SOCKET-VERO13-18
C12479_MIRELLA-DL
Bender Wirth: 438 Typ L1

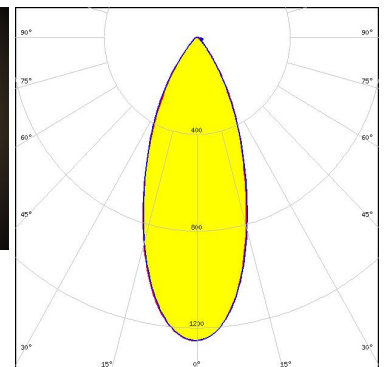
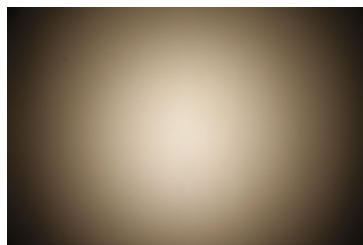

Light distribution files

OPTICAL RESULTS (MEASURED):



LED LUXEON CoB 1202/1203
FWHM / FWTM 39.0° / 74.0°
Efficiency 80 %
Peak intensity 1.5 cd/lm
LEDs/each optic 1
Light colour/type White
Required components:
C13333_MIRELLA-CL
IDEAL: 50-2100NC +50-2100MR

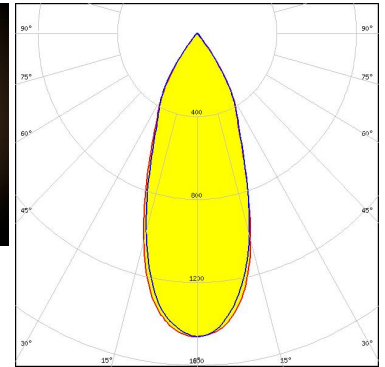
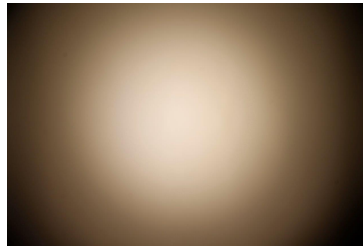

Light distribution files



LED LUXEON CoB 1202/1203
FWHM / FWTM 37.0° / 72.0°
Efficiency 77 %
Peak intensity 1.5 cd/lm
LEDs/each optic 1
Light colour/type White
Required components:
C13709_PF-SOCKET-VERO13-18
C13333_MIRELLA-CL
Bender Wirth: 438 Typ L1

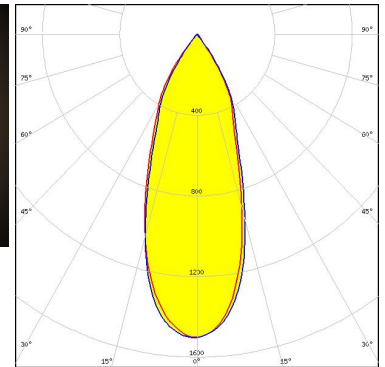
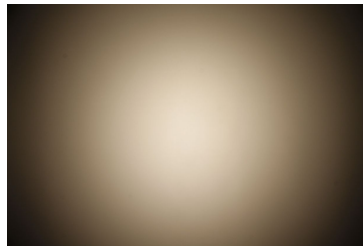

Light distribution files



LED LUXEON CoB 1202s
FWHM / FWTM 41.0° / 78.0°
Efficiency 82 %
Peak intensity 1.5 cd/lm
LEDs/each optic 1
Light colour/type White
Required components:
C13761_PF-SOCKET-CXA15
C13333_MIRELLA-CL

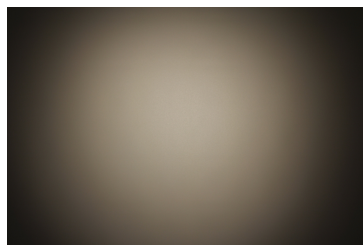

Light distribution files

OPTICAL RESULTS (MEASURED):



LED LUXEON CoB 1202s
FWHM / FWTM 40.0° / 78.0°
Efficiency 82 %
Peak intensity 1.5 cd/lm
LEDs/each optic 1
Light colour/type White
Required components:
 C13761_PF-SOCKET-CXA15
 C12479_MIRELLA-DL

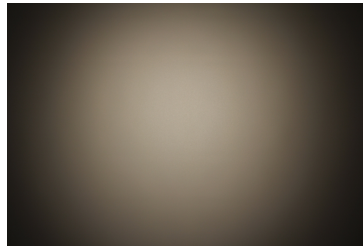

Light distribution files



LED LUXEON CoB 1202s
FWHM / FWTM 32.0° / 71.0°
Efficiency 77 %
Peak intensity 1.6 cd/lm
LEDs/each optic 1
Light colour/type White
Required components:
 C13709_PF-SOCKET-VERO13-18
 C12479_MIRELLA-DL
 Bender Wirth: 452 Typ L1

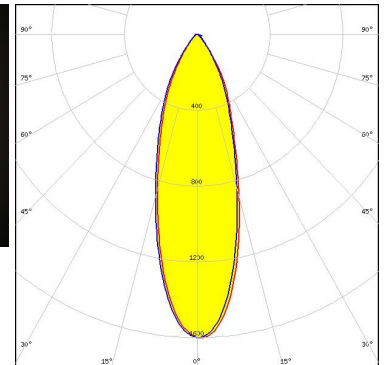
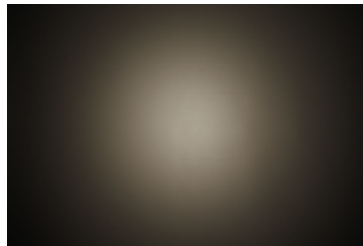

Light distribution files



LED LUXEON CoB 1202s
FWHM / FWTM 28.0° / 69.0°
Efficiency 81 %
Peak intensity 2.2 cd/lm
LEDs/each optic 1
Light colour/type White
Required components:
 C13709_PF-SOCKET-VERO13-18
 C13333_MIRELLA-CL
 Bender Wirth: 452 Typ L1

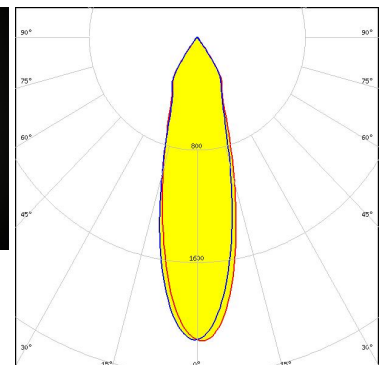
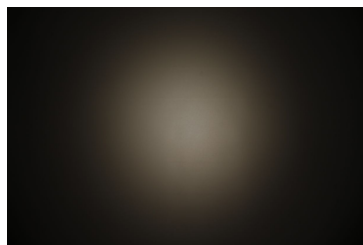

Light distribution files

OPTICAL RESULTS (MEASURED):



LED LUXEON CoB 1202s
FWHM / FWTM 35.0° / 82.0°
Efficiency 88 %
Peak intensity 1.9 cd/lm
LEDs/each optic 1
Light colour/type White
Required components:
C13761_PF-SOCKET-CXA15

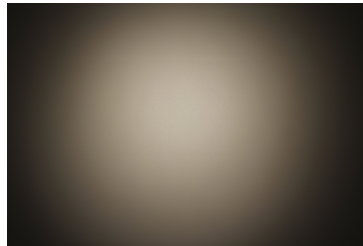

Light distribution files



LED LUXEON CoB 1202s
FWHM / FWTM 25.0° / 72.0°
Efficiency 85 %
Peak intensity 2.6 cd/lm
LEDs/each optic 1
Light colour/type White
Required components:
C13709_PF-SOCKET-VERO13-18
Bender Wirth: 452 Typ L1

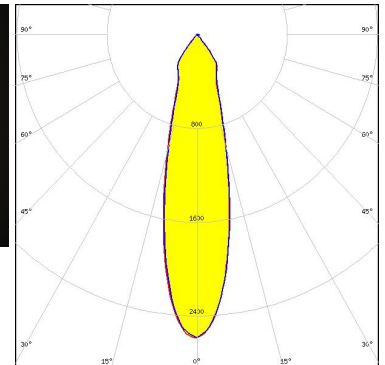
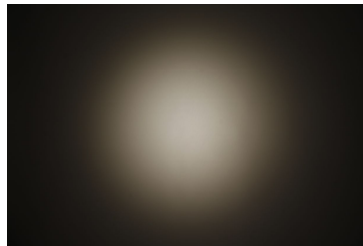

Light distribution files



LED LUXEON Z
FWHM / FWTM 36.0° / 75.0°
Efficiency 79 %
Peak intensity 1.5 cd/lm
LEDs/each optic 4
Light colour/type RGBW
Required components:
C13083_PF-SOCKET
C13723_MIRELLA-RZL

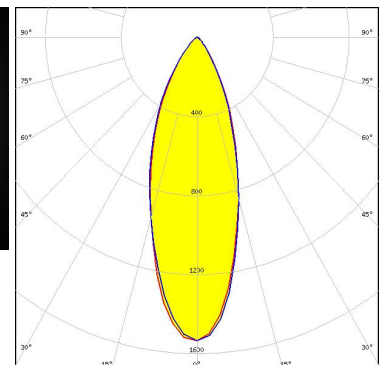
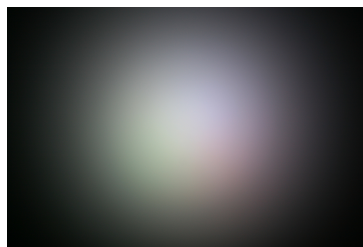

Light distribution files

OPTICAL RESULTS (MEASURED):



LED CxM-6 (12x13)
FWHM / FWTM 36.0° / 79.0°
Efficiency 85 %
Peak intensity 1.8 cd/lm
LEDs/each optic 1
Light colour/type White
Required components:
 C13083_PF-SOCKET

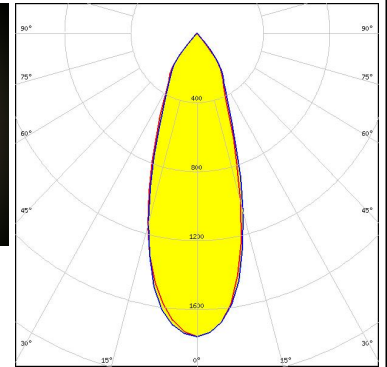
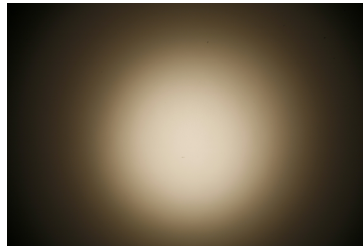

Light distribution files



LED CXM-7 (13x13)
FWHM / FWTM 38.0° / 79.0°
Efficiency 86 %
Peak intensity 1.6 cd/lm
LEDs/each optic 1
Light colour/type White
Required components:
 C13083_PF-SOCKET

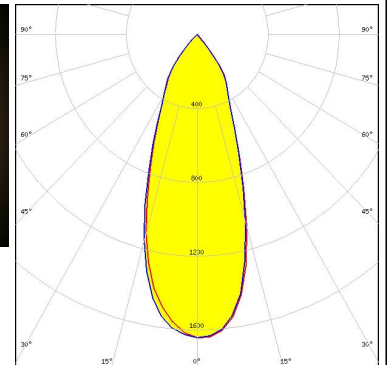
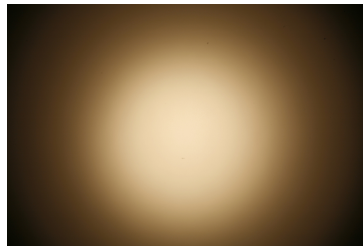

Light distribution files



LED CxM-9 (13.5x13.5)
FWHM / FWTM 44.0° / 82.0°
Efficiency 88 %
Peak intensity 1.3 cd/lm
LEDs/each optic 1
Light colour/type White
Required components:
 C13083_PF-SOCKET

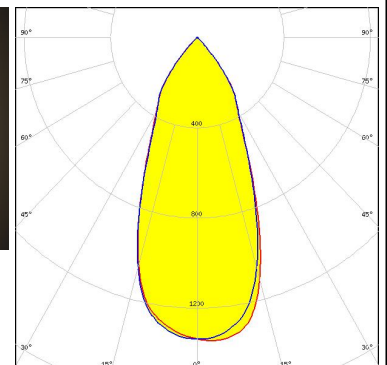
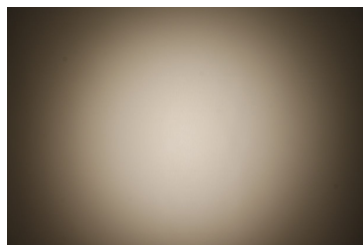

Light distribution files

OPTICAL RESULTS (MEASURED):



LED CxM-9 (13.5x13.5)
 FWHM / FWTM 48.0° / 83.0°
 Efficiency 80 %
 Peak intensity 1.1 cd/lm
 LEDs/each optic 1
 Light colour/type White
 Required components:
 C13083_PF-SOCKET
 C13723_MIRELLA-RZL

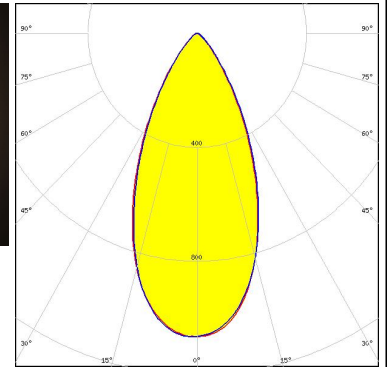
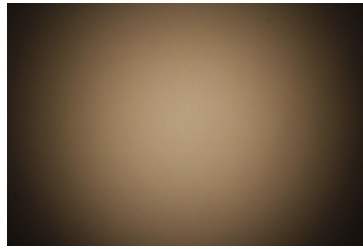

Light distribution files



LED CxM-9 (13.5x13.5)
 FWHM / FWTM 49.0° / 79.0°
 Efficiency 83 %
 Peak intensity 1.1 cd/lm
 LEDs/each optic 1
 Light colour/type White
 Required components:
 C13083_PF-SOCKET
 C12479_MIRELLA-DL

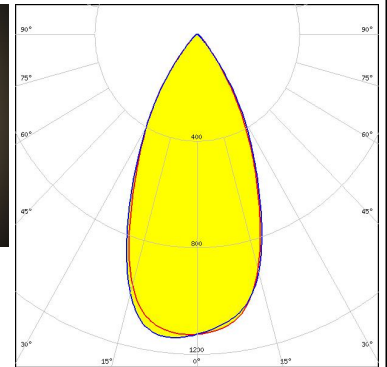
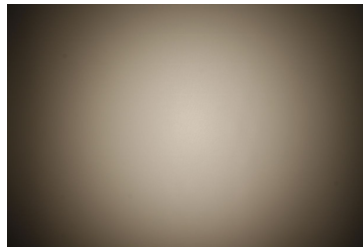

Light distribution files



LED CxM-9 (13.5x13.5)
 FWHM / FWTM 48.0° / 78.0°
 Efficiency 83 %
 Peak intensity 1.2 cd/lm
 LEDs/each optic 1
 Light colour/type White
 Required components:
 C13083_PF-SOCKET
 C13333_MIRELLA-CL

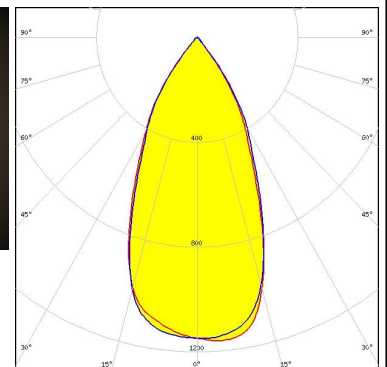
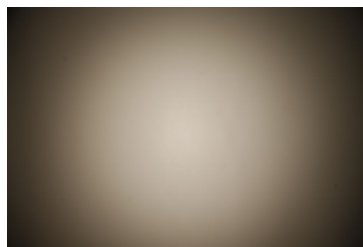

Light distribution files

OPTICAL RESULTS (MEASURED):



LED COB L-Type (LES 11)
FWHM / FWTM 47.0° / 77.0°
Efficiency 81 %
Peak intensity 1.2 cd/lm
LEDs/each optic 1
Light colour/type White
Required components:
C13333_MIRELLA-CL
IDEAL: 50-2100NC +50-2100MR

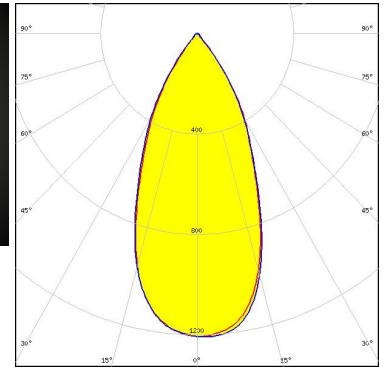
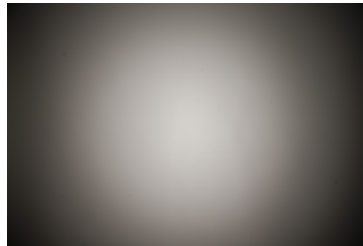

Light distribution files



LED COB L-Type (LES 11)
FWHM / FWTM 45.0° / 75.0°
Efficiency 77 %
Peak intensity 1.2 cd/lm
LEDs/each optic 1
Light colour/type White
Required components:
C13709_PF-SOCKET-VERO13-18
C13333_MIRELLA-CL
Bender Wirth: 438 Typ L1

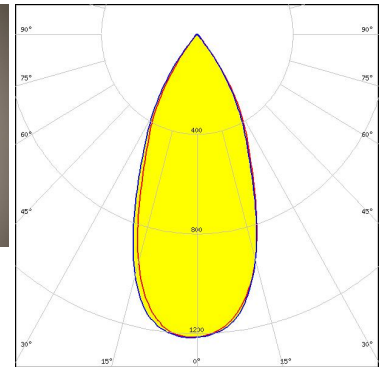
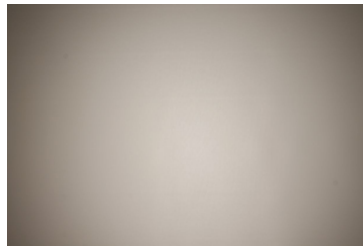

Light distribution files



LED COB L-Type (LES 11)
FWHM / FWTM 46.0° / 82.0°
Efficiency 84 %
Peak intensity 1.3 cd/lm
LEDs/each optic 1
Light colour/type White
Required components:
C14037_PF-NSX-SOCKET

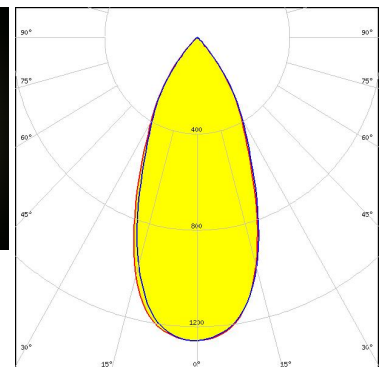
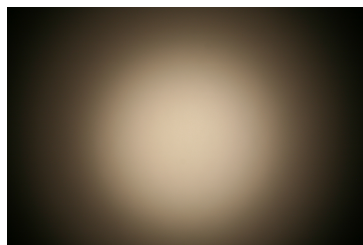

Light distribution files

OPTICAL RESULTS (MEASURED):



LED COB L-Type (LES 11)
FWHM / FWTM 41.0° / 79.0°
Efficiency 81 %
Peak intensity 1.4 cd/lm
LEDs/each optic 1
Light colour/type White
Required components:
C13709_PF-SOCKET-VERO13-18
Bender Wirth: 438 Typ L1

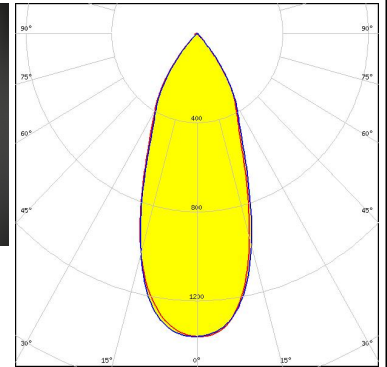

Light distribution files



LED COB L-Type (LES 11)
FWHM / FWTM 46.0° / 77.0°
Efficiency 80 %
Peak intensity 1.2 cd/lm
LEDs/each optic 1
Light colour/type White
Required components:
C12479_MIRELLA-DL
IDEAL: 50-2100NC +50-2100MR

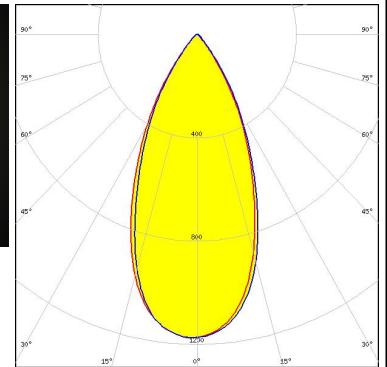
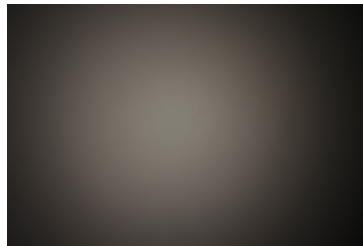

Light distribution files



LED COB L-Type (LES 11)
FWHM / FWTM 46.0° / 78.0°
Efficiency 75 %
Peak intensity 1.1 cd/lm
LEDs/each optic 1
Light colour/type White
Required components:
C13709_PF-SOCKET-VERO13-18
C12479_MIRELLA-DL
Bender Wirth: 438 Typ L1

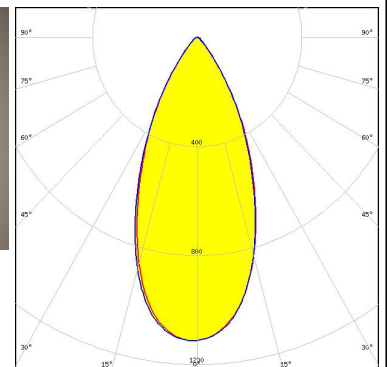
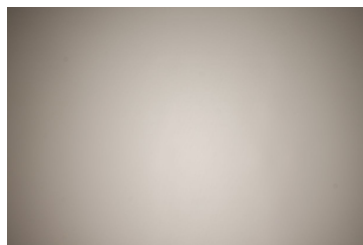

Light distribution files

OPTICAL RESULTS (MEASURED):



LED COB L-Type (LES 11)
FWHM / FWTM 43.0° / 80.0°
Efficiency 86 %
Peak intensity 1.4 cd/lm
LEDs/each optic 1
Light colour/type White
Required components:
IDEAL: 50-2100NC +50-2100MR

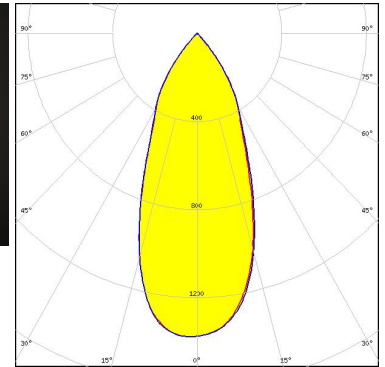
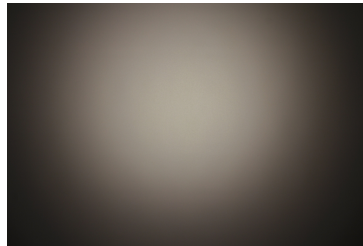

Light distribution files



LED COB L-Type (LES 9)
FWHM / FWTM 38.0° / 78.0°
Efficiency 86 %
Peak intensity 1.6 cd/lm
LEDs/each optic 1
Light colour/type White
Required components:
C14037_PF-NSX-SOCKET

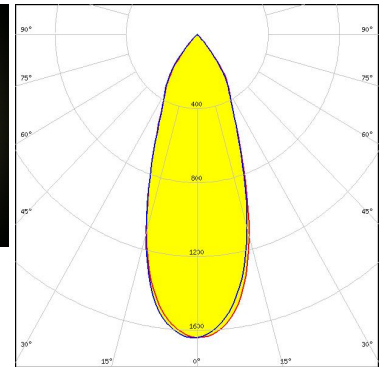
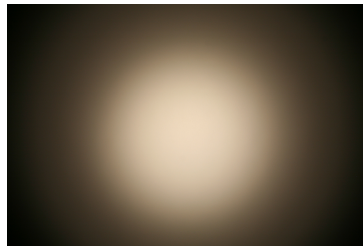

Light distribution files



LED COB L-Type (LES 9)
FWHM / FWTM 40.0° / 75.0°
Efficiency 76 %
Peak intensity 1.3 cd/lm
LEDs/each optic 1
Light colour/type White
Required components:
C13709_PF-SOCKET-VERO13-18
C12479_MIRELLA-DL
Bender Wirth: 438 Typ L1

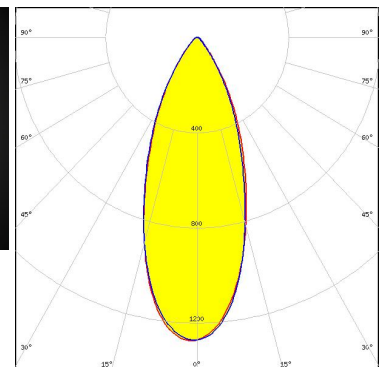
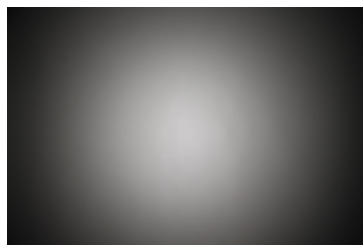

Light distribution files

OPTICAL RESULTS (MEASURED):



LED COB L-Type (LES 9)
FWHM / FWTM 39.0° / 73.0°
Efficiency 80 %
Peak intensity 1.4 cd/lm
LEDs/each optic 1
Light colour/type White
Required components:
 C12479_MIRELLA-DL
 IDEAL: 50-2100NC +50-2100MR

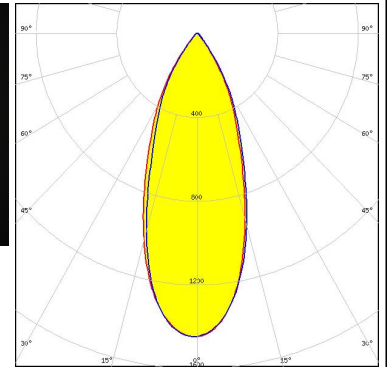

Light distribution files



LED COB L-Type (LES 9)
FWHM / FWTM 35.0° / 77.0°
Efficiency 87 %
Peak intensity 1.8 cd/lm
LEDs/each optic 1
Light colour/type White
Required components:
 IDEAL: 50-2100NC +50-2100MR

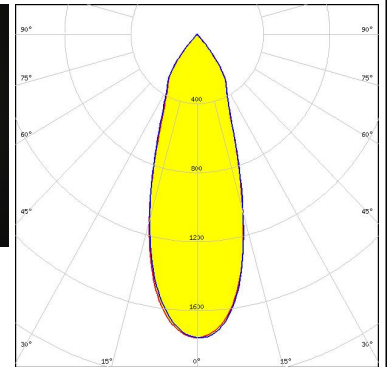
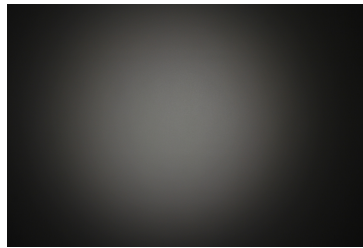

Light distribution files



LED COB L-Type (LES 9)
FWHM / FWTM 37.0° / 73.0°
Efficiency 79 %
Peak intensity 1.5 cd/lm
LEDs/each optic 1
Light colour/type White
Required components:
 C13709_PF-SOCKET-VERO13-18
 C13333_MIRELLA-CL
 Bender Wirth: 438 Typ L1

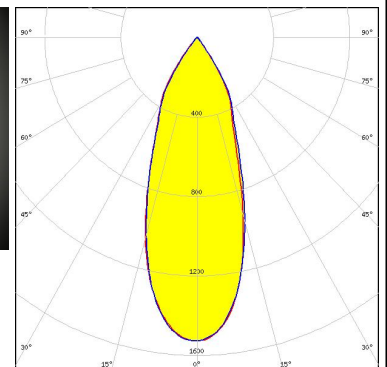
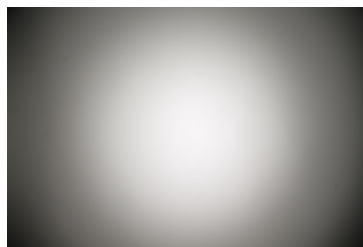

Light distribution files

OPTICAL RESULTS (MEASURED):



LED COB L-Type (LES 9)
FWHM / FWTM 38.0° / 73.0°
Efficiency 81 %
Peak intensity 1.5 cd/lm
LEDs/each optic 1
Light colour/type White
Required components:
C13333_MIRELLA-CL
IDEAL: 50-2100NC +50-2100MR

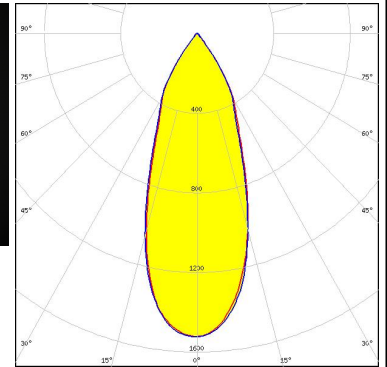
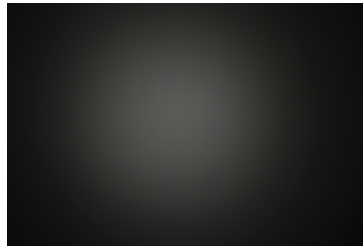

Light distribution files



LED COB L-Type (LES 9)
FWHM / FWTM 34.0° / 76.0°
Efficiency 84 %
Peak intensity 1.8 cd/lm
LEDs/each optic 1
Light colour/type White
Required components:
C13709_PF-SOCKET-VERO13-18
Bender Wirth: 438 Typ L1

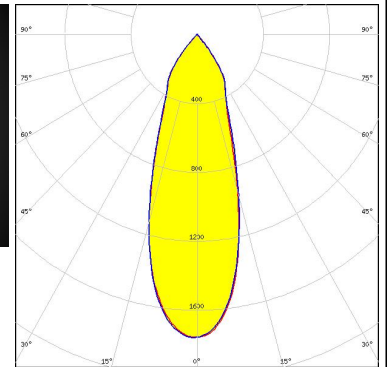
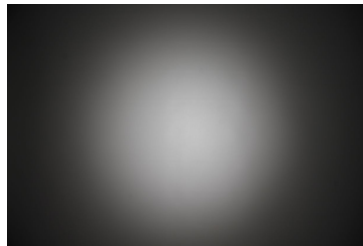

Light distribution files



LED NSCxL036A
FWHM / FWTM 34.0° / 76.0°
Efficiency 85 %
Peak intensity 1.9 cd/lm
LEDs/each optic 1
Light colour/type White
Required components:
C14037_PF-NSX-SOCKET

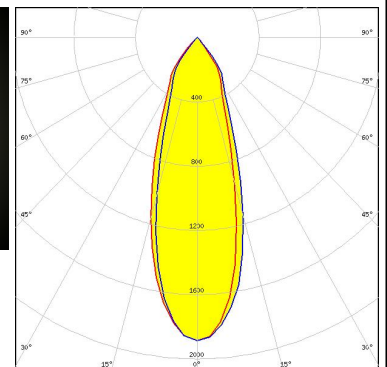
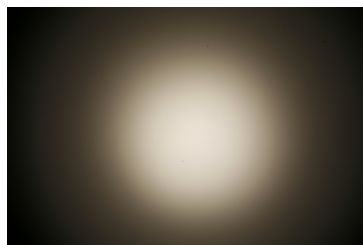

Light distribution files

OPTICAL RESULTS (MEASURED):

OSRAM
Opto Semiconductors

LED Duris S10
FWHM / FWTM 38.0° / 82.0°
Efficiency 87 %
Peak intensity 1.7 cd/lm
LEDs/each optic 1
Light colour/type White

Required components:
C13083_PF-SOCKET

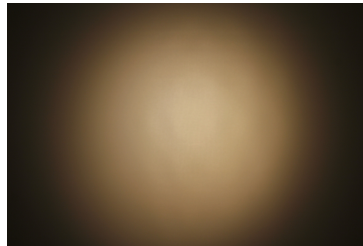

Light distribution files

OSRAM
Opto Semiconductors

LED Duris S10
FWHM / FWTM 45.0° / 82.0°
Efficiency 80 %
Peak intensity 1.3 cd/lm
LEDs/each optic 1
Light colour/type White

Required components:
C13083_PF-SOCKET
C13723_MIRELLA-RZL

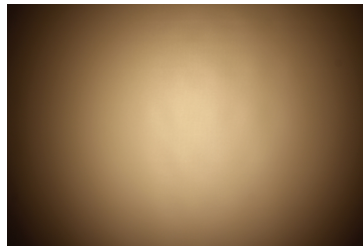

Light distribution files

OSRAM
Opto Semiconductors

LED Duris S10
FWHM / FWTM 45.0° / 81.0°
Efficiency 79 %
Peak intensity 1.3 cd/lm
LEDs/each optic 1
Light colour/type White

Required components:
C13083_PF-SOCKET
C12479_MIRELLA-DL

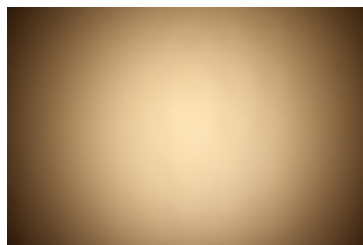

Light distribution files

OPTICAL RESULTS (MEASURED):

OSRAM
Opto Semiconductors

LED Duris S10
FWHM / FWTM 43.0°
Efficiency %
LEDs/each optic 1
Light colour/type White

Required components:
C13083_PF-SOCKET
C13333_MIRELLA-CL

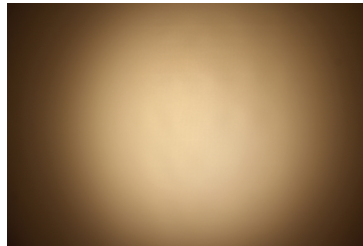

Light distribution files

OSRAM
Opto Semiconductors

LED OSTAR Stage (S2WP)
FWHM / FWTM 36.0° / 78.0°
Efficiency 83 %
Peak intensity 1.6 cd/lm
LEDs/each optic 1
Light colour/type White

Required components:
C13083_PF-SOCKET
C13723_MIRELLA-RZL

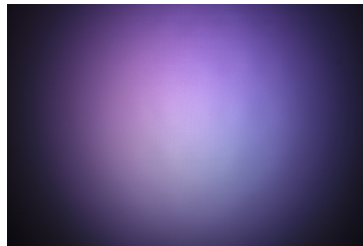

Light distribution files

OSRAM
Opto Semiconductors

LED Ostar-SMT RGB
FWHM / FWTM 37.0° / 77.0°
Efficiency 81 %
Peak intensity 1.5 cd/lm
LEDs/each optic 1
Light colour/type White

Required components:
C13083_PF-SOCKET
C13723_MIRELLA-RZL

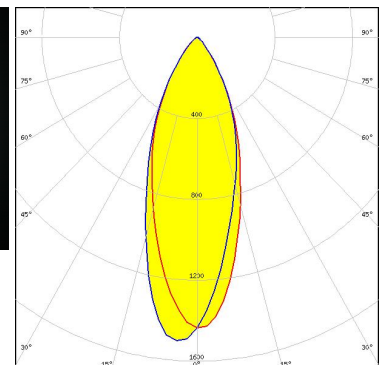
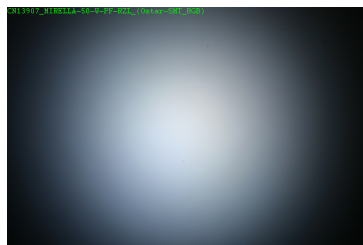

Light distribution files

OPTICAL RESULTS (MEASURED):

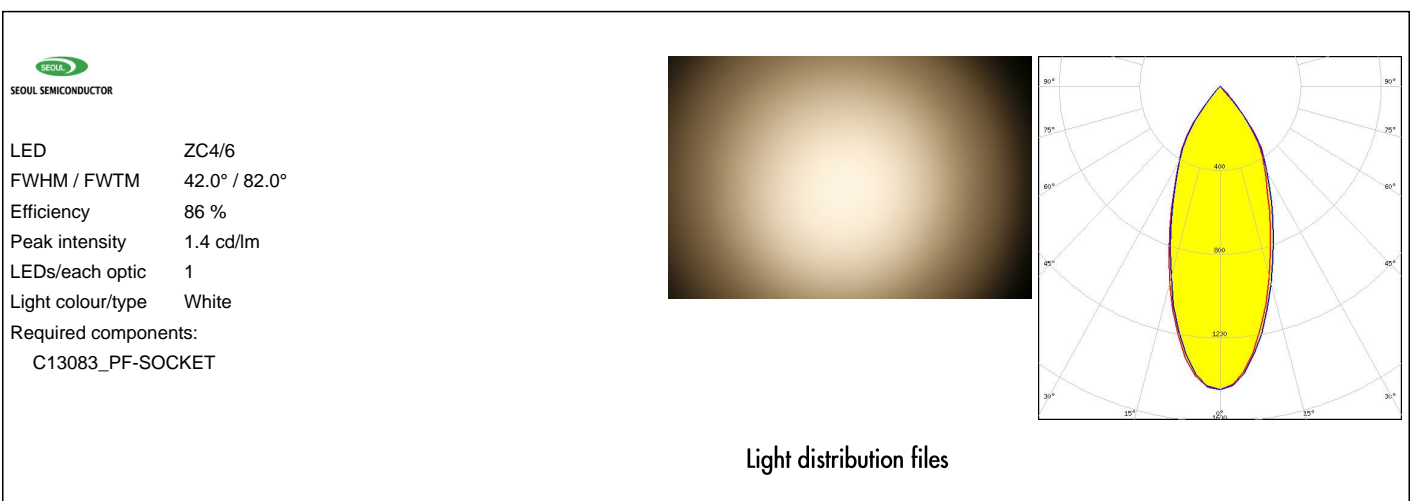
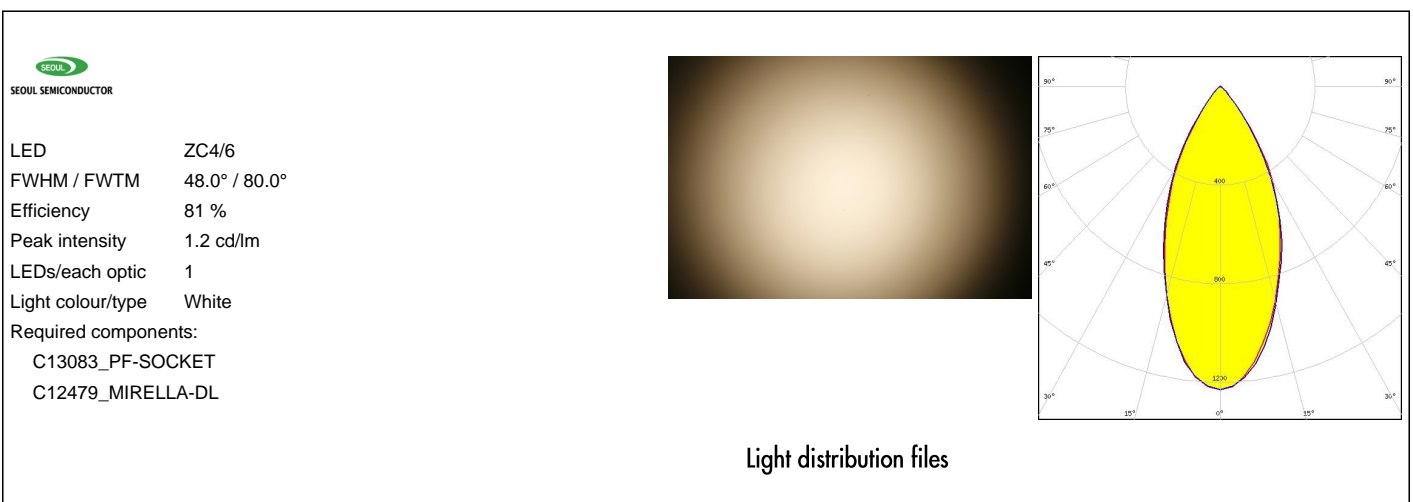
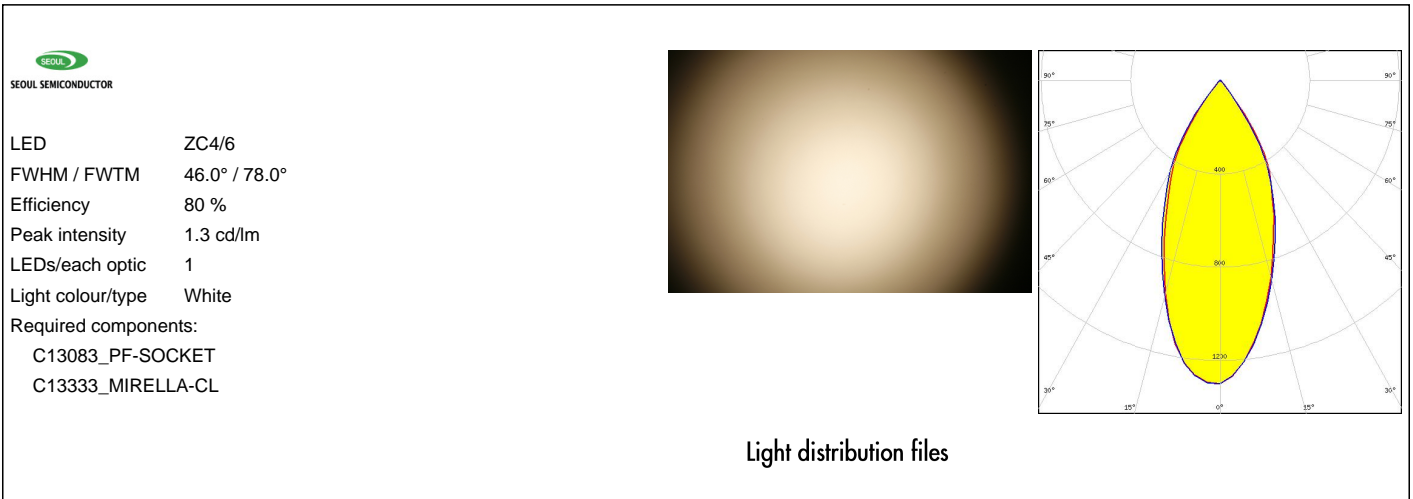

OPTICAL RESULTS (MEASURED):

SHARP

LED Mini Zenigata (GW6BM)
FWHM / FWTM 46.0° / 78.0°
Efficiency 81 %
Peak intensity 1.3 cd/lm
LEDs/each optic 1
Light colour/type White
Required components:
C13083_PF-SOCKET
C13333_MIRELLA-CL

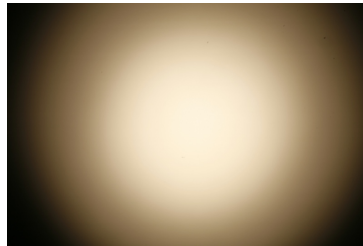

Light distribution files

SHARP

LED Mini Zenigata (GW6BM)
FWHM / FWTM 38.0° / 81.0°
Efficiency 88 %
Peak intensity 1.5 cd/lm
LEDs/each optic 1
Light colour/type White
Required components:
C13083_PF-SOCKET

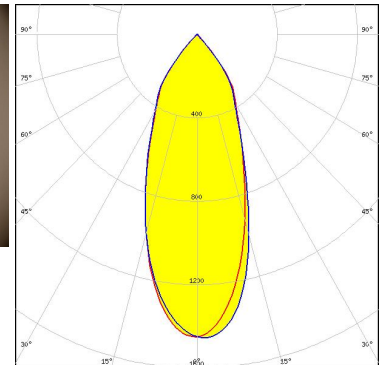
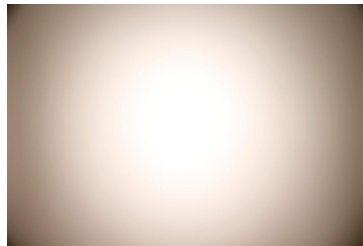

Light distribution files

SHARP

LED Mini Zenigata (GW6BM)
FWHM / FWTM 45.0° / 80.0°
Efficiency 81 %
Peak intensity 1.1 cd/lm
LEDs/each optic 1
Light colour/type White
Required components:
C13083_PF-SOCKET
C12479_MIRELLA-DL

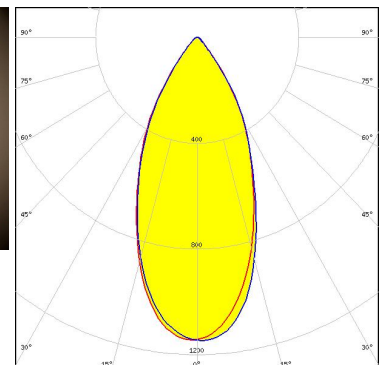
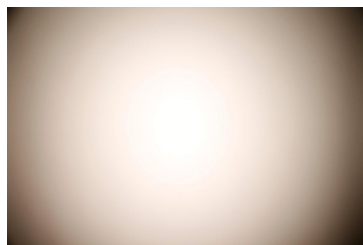

Light distribution files

OPTICAL RESULTS (MEASURED):

XICATO

LED XTM - 9mm LES
FWHM / FWTM 35.0° / 76.0°
Efficiency 83 %
Peak intensity 1.7 cd/lm
LEDs/each optic 1
Light colour/type White
Required components:
C14636_XTM-PF-ADAPTER

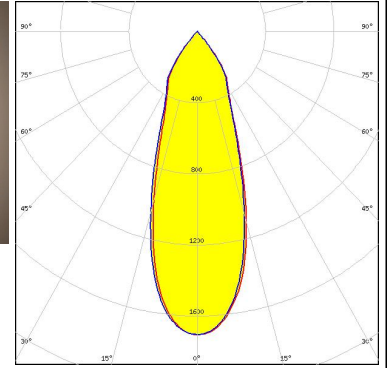
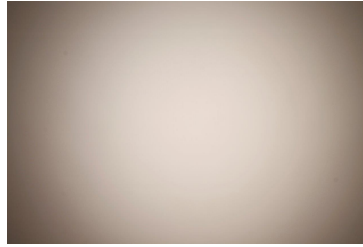

Light distribution files

OPTICAL RESULTS (SIMULATED):

CITIZEN

LED CLL02x/CLU02x (LES10)
 FWHM / FWTM 48.0° / 84.0°
 Efficiency 91 %
 Peak intensity 1.3 cd/lm
 LEDs/each optic 1
 Light colour/type White
 Required components:
 C13083_PF-SOCKET

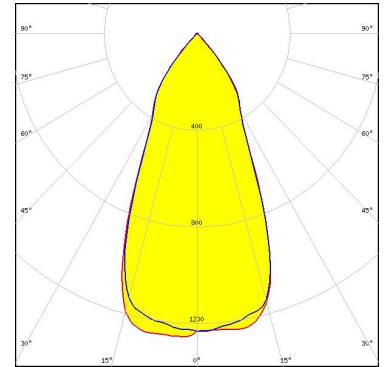

Light distribution files



LED MT-G2
 FWHM / FWTM 42.0° / 82.0°
 Efficiency 90 %
 Peak intensity 1.5 cd/lm
 LEDs/each optic 1
 Light colour/type White
 Required components:
 C13083_PF-SOCKET

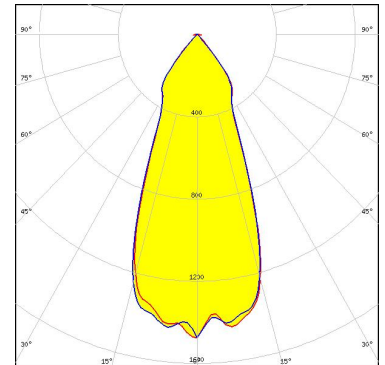

Light distribution files



LED XM-L RGBW (XMLDCL HD)
 FWHM / FWTM 47.0° / 80.0°
 Efficiency 85 %
 Peak intensity 1.2 cd/lm
 LEDs/each optic 1
 Light colour/type RGBW
 Required components:
 C13083_PF-SOCKET
 C13723_MIRELLA-RZL

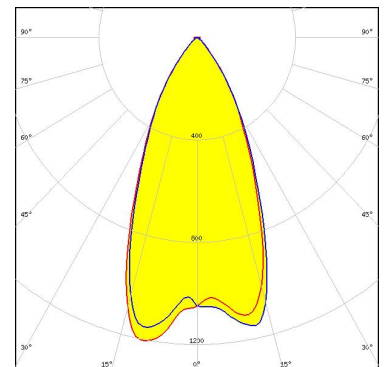

Light distribution files

Protective plate, glass

OPTICAL RESULTS (SIMULATED):



LED LUXEON CoB Compact
FWHM / FWTM 35.0° / 82.0°
Efficiency 88 %
Peak intensity 1.9 cd/lm
LEDs/each optic 1
Light colour/type White

Required components:

C13761_PF-SOCKET-CXA15

[Light distribution files](#)



LED LUXEON CoB Compact
FWHM / FWTM 32.0° / 71.0°
Efficiency 77 %
Peak intensity 1.6 cd/lm
LEDs/each optic 1
Light colour/type White

Required components:

C13709_PF-SOCKET-VERO13-18
C12479_MIRELLA-DL

[Light distribution files](#)

Bender Wirth: 452 Typ L1



LED LUXEON CoB Compact
FWHM / FWTM 40.0° / 78.0°
Efficiency 82 %
Peak intensity 1.5 cd/lm
LEDs/each optic 1
Light colour/type White

Required components:

C13761_PF-SOCKET-CXA15
C12479_MIRELLA-DL

[Light distribution files](#)

OPTICAL RESULTS (SIMULATED):



LED LUXEON CoB Compact
FWHM / FWTM 25.0° / 72.0°
Efficiency 85 %
Peak intensity 2.6 cd/lm
LEDs/each optic 1
Light colour/type White

Required components:

C13709_PF-SOCKET-VERO13-18

Bender Wirth: 452 Typ L1

[Light distribution files](#)



LED LUXEON CoB Compact
FWHM / FWTM 41.0° / 78.0°
Efficiency 82 %
Peak intensity 1.5 cd/lm
LEDs/each optic 1
Light colour/type White

Required components:

C13761_PF-SOCKET-CXA15

C13333_MIRELLA-CL

[Light distribution files](#)



LED LUXEON CoB Compact
FWHM / FWTM 37.0° / 72.0°
Efficiency 77 %
Peak intensity 1.5 cd/lm
LEDs/each optic 1
Light colour/type White

Required components:

C13709_PF-SOCKET-VERO13-18

C13333_MIRELLA-CL

Bender Wirth: 452 Typ L1

[Light distribution files](#)

OPTICAL RESULTS (SIMULATED):



LED LUXEON K4
FWHM / FWTM 46.0° / 84.0°
Efficiency 88 %
Peak intensity 1.3 cd/lm
LEDs/each optic 1
Light colour/type White

Required components:

C13761_PF-SOCKET-CXA15

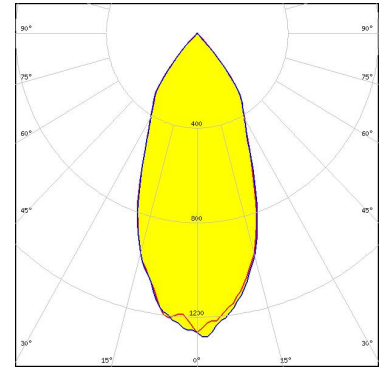

Light distribution files



LED LUXEON K4
FWHM / FWTM 54.0° / 98.0°
Efficiency 83 %
Peak intensity 0.9 cd/lm
LEDs/each optic 1
Light colour/type White

Required components:

C13761_PF-SOCKET-CXA15

C12479_MIRELLA-DL

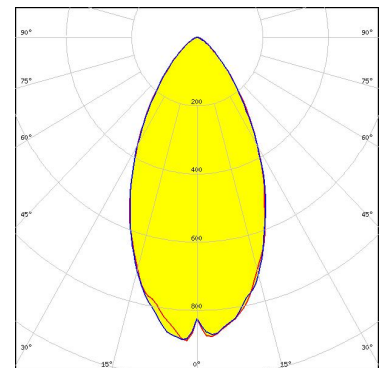

Light distribution files



LED CxM-14 (19x19)
FWHM / FWTM 51.0° / 81.0°
Efficiency 70 %
Peak intensity 0.9 cd/lm
LEDs/each optic 1
Light colour/type White

Required components:

C13709_PF-SOCKET-VERO13-18

C12479_MIRELLA-DL

Light distribution files

Bender Wirth: 433 Typ L1

OPTICAL RESULTS (SIMULATED):



LED CxM-14 (19x19)
FWHM / FWTM 49.0° / 72.0°
Efficiency 75 %
Peak intensity 1 cd/lm
LEDs/each optic 1
Light colour/type White

Required components:

C13709_PF-SOCKET-VERO13-18

Bender Wirth: 433 Typ L1

[Light distribution files](#)



LED CxM-9 (13.5x13.5)
FWHM / FWTM 41.0° / 76.0°
Efficiency 76 %
Peak intensity 1.3 cd/lm
LEDs/each optic 1
Light colour/type White

Required components:

C13709_PF-SOCKET-VERO13-18

C12479_MIRELLA-DL

Bender Wirth: 434 Typ L1

[Light distribution files](#)



LED CxM-9 (13.5x13.5)
FWHM / FWTM 39.0° / 73.0°
Efficiency 78 %
Peak intensity 1.5 cd/lm
LEDs/each optic 1
Light colour/type White

Required components:

C13709_PF-SOCKET-VERO13-18

C13333_MIRELLA-CL

Bender Wirth: 434 Typ L1

[Light distribution files](#)

OPTICAL RESULTS (SIMULATED):



LED CxM-9 (13.5x13.5)
FWHM / FWTM 36.0° / 77.0°
Efficiency 84 %
Peak intensity 1.7 cd/lm
LEDs/each optic 1
Light colour/type White

Required components:

C13709_PF-SOCKET-VERO13-18

Bender Wirth: 434 Typ L1

[Light distribution files](#)



LED COB S-Type (LES 7)
FWHM / FWTM 28.0° / 69.0°
Efficiency 81 %
Peak intensity 2.2 cd/lm
LEDs/each optic 1
Light colour/type White

Required components:

C13709_PF-SOCKET-VERO13-18

C13333_MIRELLA-CL

Bender Wirth: 452 Typ L1

[Light distribution files](#)



LED COB S-Type (LES 7)
FWHM / FWTM 32.0° / 71.0°
Efficiency 77 %
Peak intensity 1.6 cd/lm
LEDs/each optic 1
Light colour/type White

Required components:

C13709_PF-SOCKET-VERO13-18

C12479_MIRELLA-DL

Bender Wirth: 452 Typ L1

[Light distribution files](#)

OPTICAL RESULTS (SIMULATED):



LED COB S-Type (LES 7)
FWHM / FWTM 25.0° / 72.0°
Efficiency 85 %
Peak intensity 2.6 cd/lm
LEDs/each optic 1
Light colour/type White

Required components:

C13709_PF-SOCKET-VERO13-18

Bender Wirth: 452 Typ L1

[Light distribution files](#)



LED Soleriq S15
FWHM / FWTM 56.0° / 86.0°
Efficiency 86 %
Peak intensity 1.1 cd/lm
LEDs/each optic 1
Light colour/type White

Required components:

C13709_PF-SOCKET-VERO13-18

Bender Wirth: 433 Typ L1

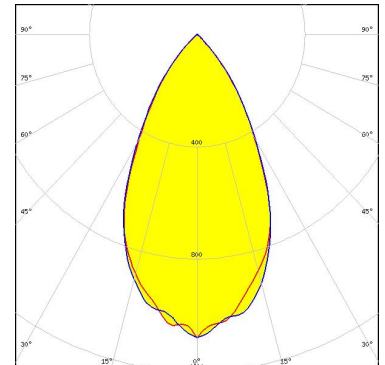

[Light distribution files](#)



LED Soleriq S9
FWHM / FWTM 46.0° / 82.0°
Efficiency 91 %
Peak intensity 1.4 cd/lm
LEDs/each optic 1
Light colour/type White

Required components:

C13083_PF-SOCKET

Bender Wirth: 433 Typ L1

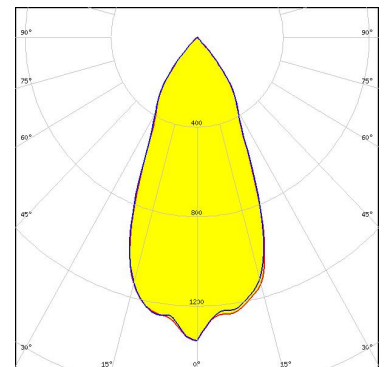

[Light distribution files](#)

OPTICAL RESULTS (SIMULATED):

OSRAM
Opto Semiconductors

LED Soleriq S9
FWHM / FWTM 52.0° / 79.0°
Efficiency 85 %
Peak intensity 1.1 cd/lm
LEDs/each optic 1
Light colour/type White

Required components:

C13083_PF-SOCKET
C13333_MIRELLA-CL

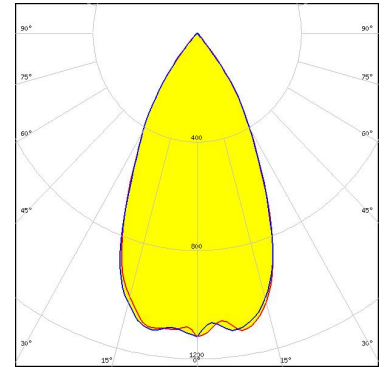

Light distribution files

OSRAM
Opto Semiconductors

LED Soleriq S9
FWHM / FWTM 50.0° / 80.0°
Efficiency 85 %
Peak intensity 1.2 cd/lm
LEDs/each optic 1
Light colour/type White

Required components:

C13083_PF-SOCKET
C13723_MIRELLA-RZL

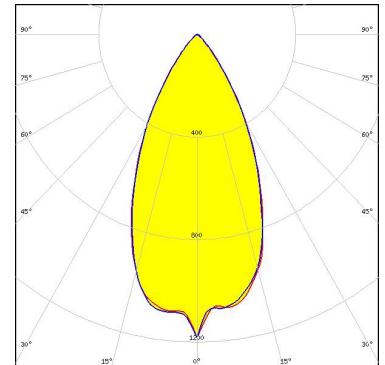

Light distribution files

OSRAM
Opto Semiconductors

LED Soleriq S9
FWHM / FWTM 38.0° / 77.0°
Efficiency 88 %
Peak intensity 1.7 cd/lm
LEDs/each optic 1
Light colour/type White

Required components:

C13709_PF-SOCKET-VERO13-18

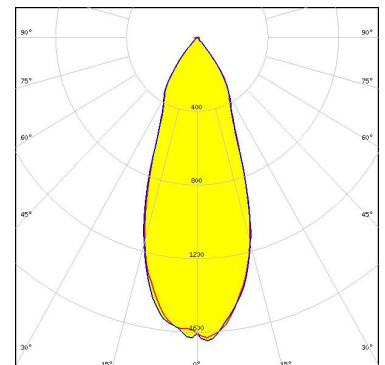

Light distribution files

OPTICAL RESULTS (SIMULATED):

OSRAM
Opto Semiconductors

LED Soleriq S9
FWHM / FWTM 51.0° / 80.0°
Efficiency 85 %
Peak intensity 1.2 cd/lm
LEDs/each optic 1
Light colour/type White

Required components:

C13083_PF-SOCKET
C12479_MIRELLA-DL

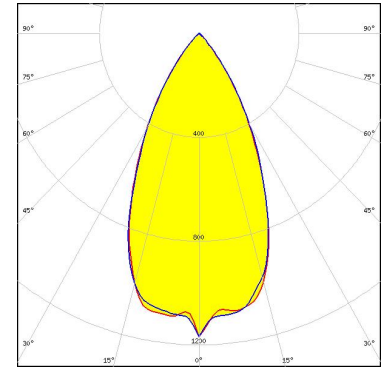

Light distribution files

SAMSUNG

LED LC010C
FWHM / FWTM 32.0° / 74.0°
Efficiency 87 %
Peak intensity 2.2 cd/lm
LEDs/each optic 1
Light colour/type White

Required components:

C13709_PF-SOCKET-VERO13-18

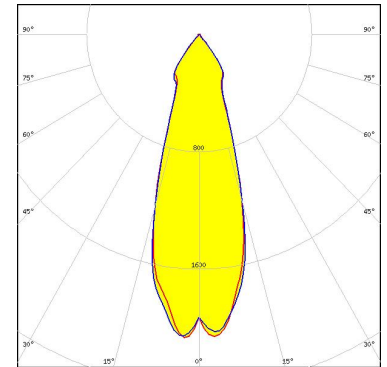

Light distribution files

SAMSUNG

LED LC020C
FWHM / FWTM 35.0° / 75.0°
Efficiency 86 %
Peak intensity 1.9 cd/lm
LEDs/each optic 1
Light colour/type White

Required components:

C13709_PF-SOCKET-VERO13-18

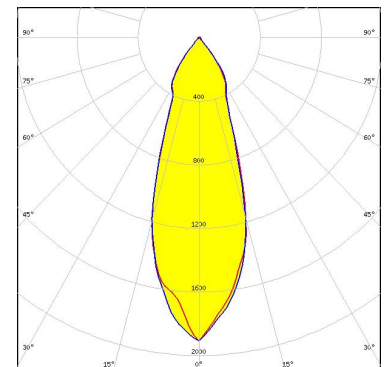

Light distribution files

OPTICAL RESULTS (SIMULATED):

SAMSUNG

LED LC040C
FWHM / FWTM 42.0° / 79.0°
Efficiency 84 %
Peak intensity 1.4 cd/lm
LEDs/each optic 1
Light colour/type White

Required components:

C13709_PF-SOCKET-VERO13-18

Bender Wirth: 480 Typ L1

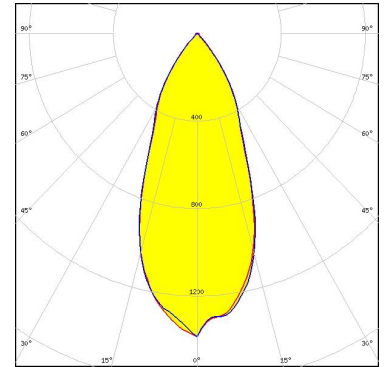

Light distribution files



SEOUL SEMICONDUCTOR

LED ZC4/6
FWHM / FWTM 41.0° / 76.0°
Efficiency 76 %
Peak intensity 1.3 cd/lm
LEDs/each optic 1
Light colour/type White

Required components:

C13709_PF-SOCKET-VERO13-18

C12479_MIRELLA-DL

Bender Wirth: 434 Typ L1



SEOUL SEMICONDUCTOR

LED ZC4/6
FWHM / FWTM 39.0° / 73.0°
Efficiency 78 %
Peak intensity 1.5 cd/lm
LEDs/each optic 1
Light colour/type White

Required components:

C13709_PF-SOCKET-VERO13-18

C13333_MIRELLA-CL

Bender Wirth: 434 Typ L1

OPTICAL RESULTS (SIMULATED):

 SEUL SEMICONDUCTOR	
LED	ZC4/6
FWHM / FWTM	36.0° / 77.0°
Efficiency	84 %
Peak intensity	1.7 cd/lm
LEDs/each optic	1
Light colour/type	White
Required components: C13709_PF-SOCKET-VERO13-18	
Bender Wirth: 434 Typ L1	

GENERAL INFORMATION:

NOTE: The typical beam angle will be changed by different color, chip size and chip position tolerance. The typical total beam angle is the full angle measured where the luminous intensity is half of the peak value.

Due to use of high power COB's with this product, special attention to proper thermal design is highly recommended. LEDiL has no liability for direct, indirect or consecutive damages arising from the LEDiL products being used outside of the recommended temperature range.

MATERIALS:

As part of our continuous research and improvement processes, and to ensure the best possible quality and availability of our products, LEDiL reserves the right to change material grades without notice.

PRODUCT DATA USER AGREEMENT AND DISCLAIMER:

The measured data in the provided downloadable LEDiL Product Datasheets and Mechanical 2D-Drawings is rounded and provided as reference for planning. LEDiL Oy's optical specifications have been verified by conducting performance testing of the products in accordance with the company's quality system. The reported data are averaged results of multiple measurements with typical variation. LEDiL Oy reserves the right to without prior notification make changes and improvements to its products.

LEDiL Oy assumes neither warranty, nor guarantee nor any other liability of any kind for the contents and correctness of the provided data. The provided data has been generated with highest diligence but the provided data may in reality not represent the complete possible variation range of all intrinsic parameters. Therefore, in certain cases a deviation from the provided data could occur.

LEDiL Oy reserves the right to undertake technical changes of its products without further notification which could lead to changes in the provided data. LEDiL Oy assumes no liability of any kind for the possible deviation from any provided data or any other damage resulting from the usage of the provided data.

The user agrees to this disclaimer and user agreement with the download or usage of the provided files.

LEDiL Oy

Joensuunkatu 7
FI-24240 SALO
Finland

LEDiL Inc.

228 West Page Street
Suite D
Sycamore IL 60178
USA

Ledil Optics Technology (Shenzhen) Co., Ltd.

405 , Block B
Casic Motor Building
Shenzhen 518057
P.R.CHINA

Local sales and technical support

[www.ledil.com/
where_to_buy](http://www.ledil.com/where_to_buy)

Shipping locations

Poznan, Poland
Hong Kong, China

Distribution Partners

[www.ledil.com/
where_to_buy](http://www.ledil.com/where_to_buy)