

MIRELLA-G2-S

~15° spot beam. Compatible with LEDiL HEKLA.

SPECIFICATION:

Dimensions	Ø 49.9 mm
Height	22.6 mm
Fastening	socket
ROHS compliant	yes ⓘ



MATERIALS:

Component	Type	Material	Colour	Finish	Coating
MIRELLA-G2-S	Reflector	PC	metal		

ORDERING INFORMATION:

Component	Qty in box	MOQ	MPQ	Box weight (kg)
F15558_MIRELLA-G2-S » Box size: 480 x 280 x 300 mm	336		28	3.2

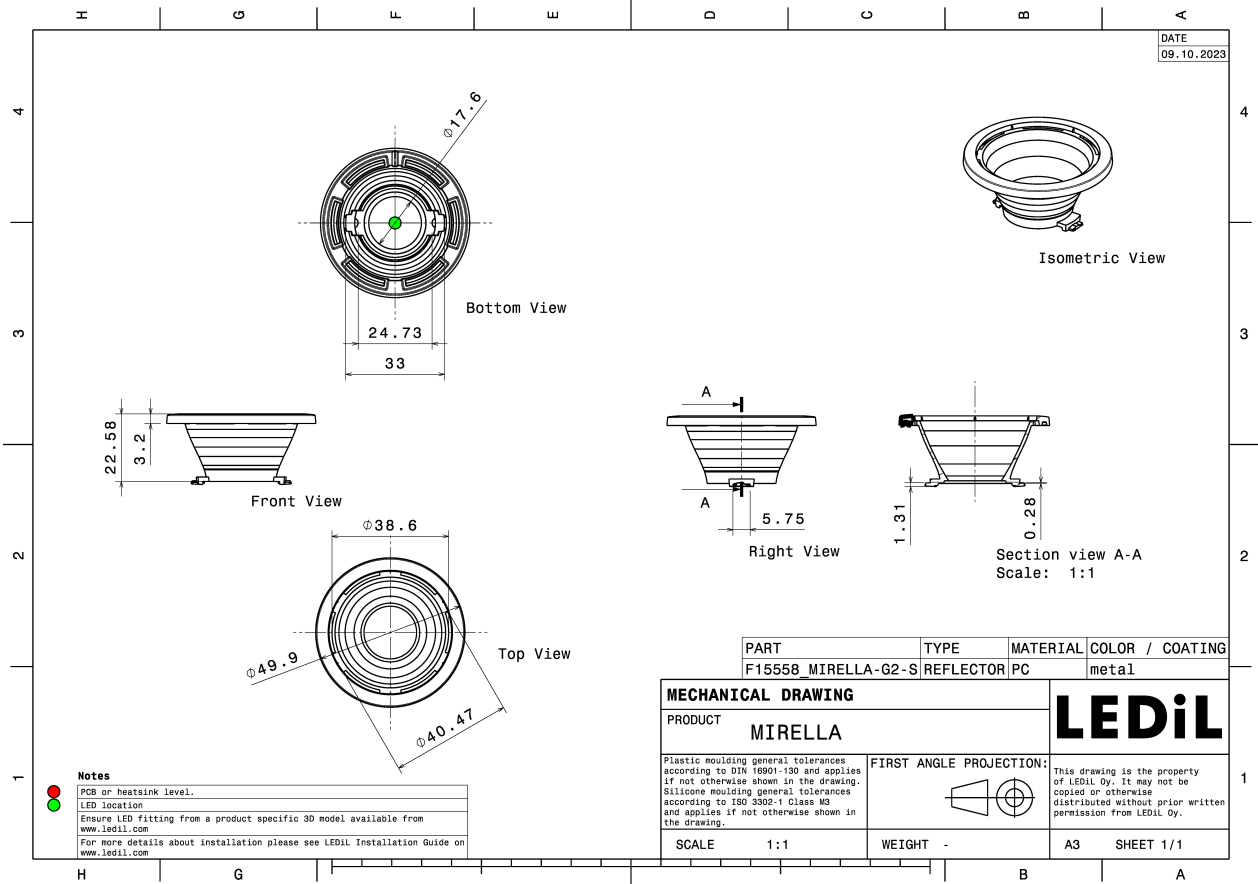

See also our general installation guide: www.ledil.com/installation_guide

OPTICAL RESULTS (MEASURED):

bridgelux

LED V4 HD Gen 7
 FWHM / FWTM 10.0° / 21.0°
 Efficiency 89 %
 Peak intensity 10.1 cd/lm
 LEDs/each optic 1
 Light colour/type White
 Required components:
 F15253_HEKLA-SOCKET-A

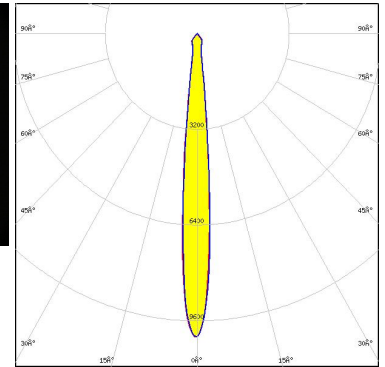

Light distribution files

bridgelux

LED V4 HD Gen 7
 FWHM / FWTM 22.0° / 62.0°
 Efficiency 80 %
 Peak intensity 2.5 cd/lm
 LEDs/each optic 1
 Light colour/type White
 Required components:
 F15253_HEKLA-SOCKET-A
 C13723_MIRELLA-RZL

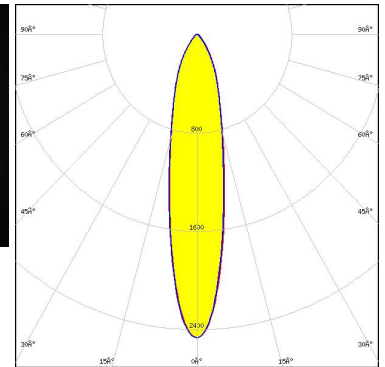
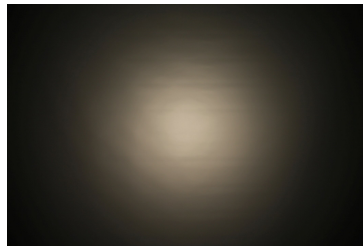

Light distribution files

bridgelux

LED V6 HD Gen 7
 FWHM / FWTM 14.0° / 33.0°
 Efficiency 87 %
 Peak intensity 5.7 cd/lm
 LEDs/each optic 1
 Light colour/type White
 Required components:
 F15255_HEKLA-SOCKET-C

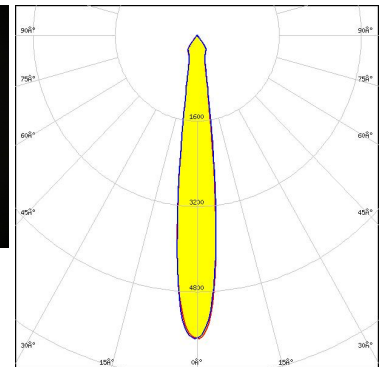
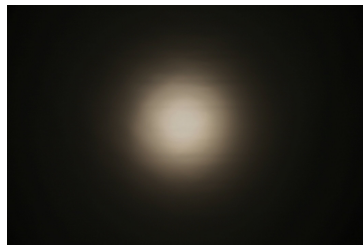

Light distribution files

OPTICAL RESULTS (MEASURED):



LED V6 HD Gen 7
 FWHM / FWTM 24.0° / 65.0°
 Efficiency 80 %
 Peak intensity 2.3 cd/lm
 LEDs/each optic 1
 Light colour/type White
 Required components:
 F15255_HEKLA-SOCKET-C
 C13723_MIRELLA-RZL

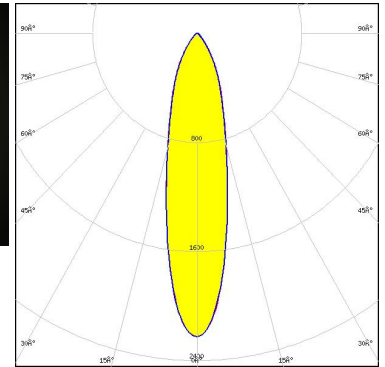
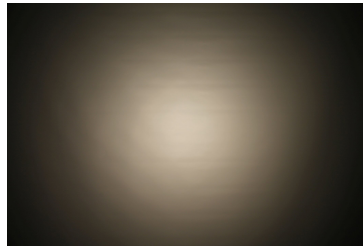

Light distribution files



LED V9 HD Gen7
 FWHM / FWTM 19.0° / 59.0°
 Efficiency 85 %
 Peak intensity 3.4 cd/lm
 LEDs/each optic 1
 Light colour/type White
 Required components:
 F15859_HEKLA-SOCKET-I

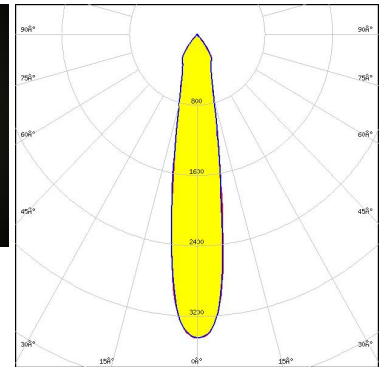
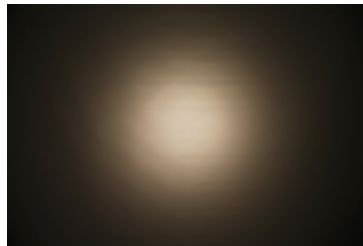

Light distribution files



LED V9 HD Gen7
 FWHM / FWTM 29.0° / 69.0°
 Efficiency 77 %
 Peak intensity 1.8 cd/lm
 LEDs/each optic 1
 Light colour/type White
 Required components:
 F15859_HEKLA-SOCKET-I
 C13723_MIRELLA-RZL

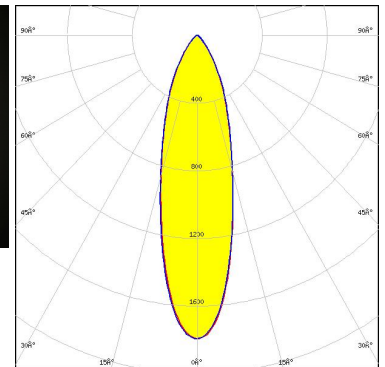
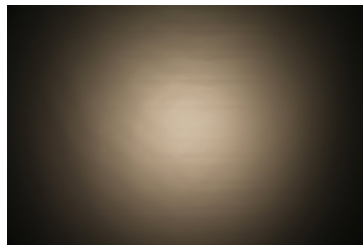

Light distribution files

OPTICAL RESULTS (MEASURED):



LED VERO10
FWHM / FWTM 19.0° / 44.0°
Efficiency 91 %
Peak intensity 4.5 cd/lm
LEDs/each optic 1
Light colour/type White
Required components:
 F15616_HEKLA-SOCKET-F

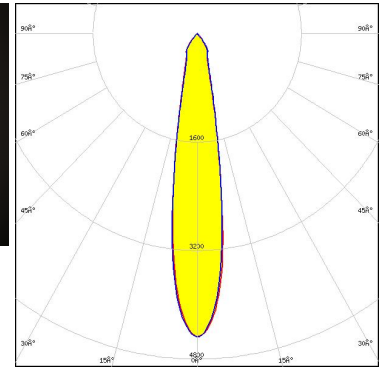

Light distribution files



LED Vesta DTW 13mm (21W)
FWHM / FWTM 30.0° / 72.0°
Efficiency 82 %
Peak intensity 1.9 cd/lm
LEDs/each optic 1
Light colour/type Tunable White
Required components:
 C16142_HEKLA-SOCKET-K
 Bender Wirth: 491 Typ L8

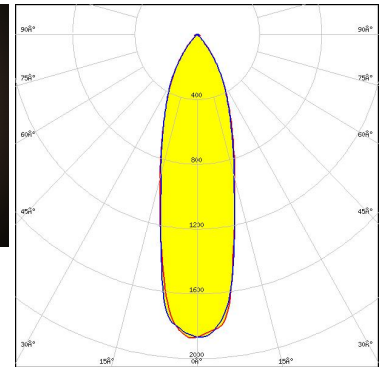
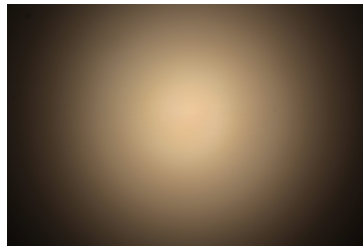

Light distribution files



LED Vesta DTW 13mm (21W)
FWHM / FWTM 39.0° / 78.0°
Efficiency 74 %
Peak intensity 1.2 cd/lm
LEDs/each optic 1
Light colour/type Tunable White
Required components:
 C16142_HEKLA-SOCKET-K
 C13723_MIRELLA-RZL
 Bender Wirth: 491 Typ L8

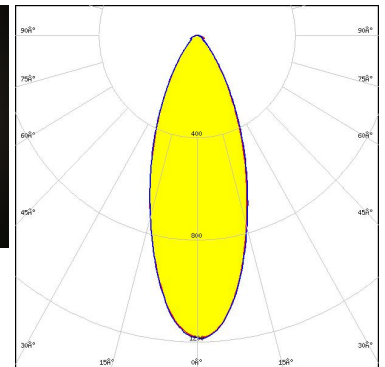
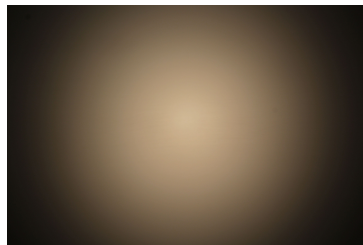

Light distribution files

OPTICAL RESULTS (MEASURED):



LED Vesta DTW 9mm (4W/6W/12W)
FWHM / FWTM 28.0° / 66.0°
Efficiency 79 %
Peak intensity 1.9 cd/lm
LEDs/each optic 1
Light colour/type White
Required components:
 C16142_HEKLA-SOCKET-K
 C13723_MIRELLA-RZL
 Bender Wirth: 490 Typ L8

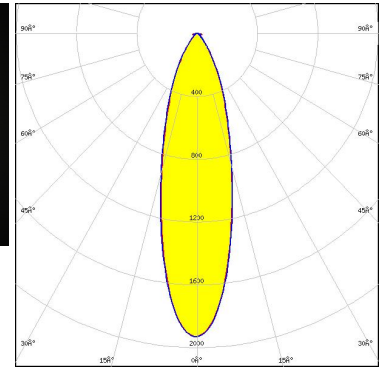
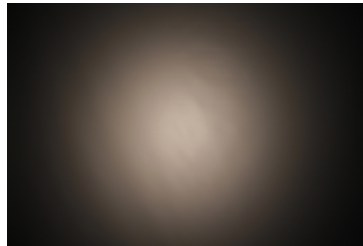

Light distribution files



LED Vesta TW 13mm (25W) CSP
FWHM / FWTM 39.0° / 77.0°
Efficiency 72 %
Peak intensity 1.2 cd/lm
LEDs/each optic 1
Light colour/type White
Required components:
 C16142_HEKLA-SOCKET-K
 C13723_MIRELLA-RZL
 Bender Wirth: 492 Typ L8

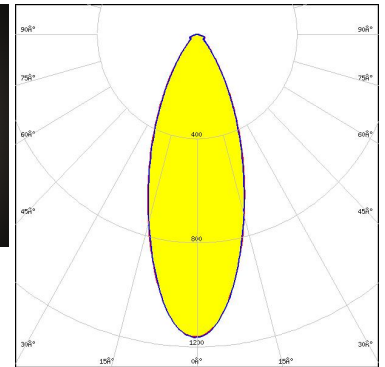
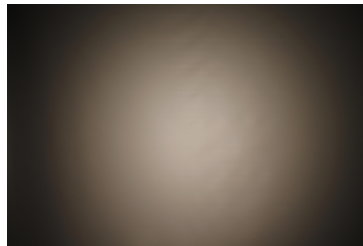

Light distribution files



LED Vesta TW 6mm DP
FWHM / FWTM 14.0° / 37.0°
Efficiency 82 %
Peak intensity 5.1 cd/lm
LEDs/each optic 1
Light colour/type White
Required components:
 C16142_HEKLA-SOCKET-K
 Bender Wirth: 504 Typ L8

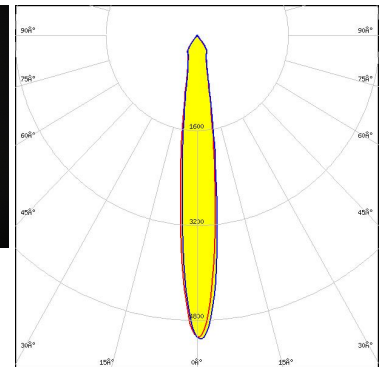
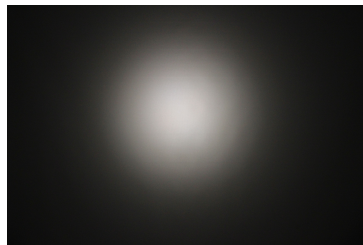

Light distribution files

OPTICAL RESULTS (MEASURED):



LED Vesta TW 6mm DP
 FWHM / FWTM 26.0° / 66.0°
 Efficiency 75 %
 Peak intensity 1.9 cd/lm
 LEDs/each optic 1
 Light colour/type White

Required components:

- C16142_HEKLA-SOCKET-K
- C13723_MIRELLA-RZL
- Bender Wirth: 504 Typ L8

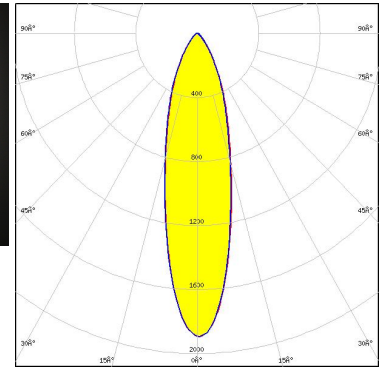
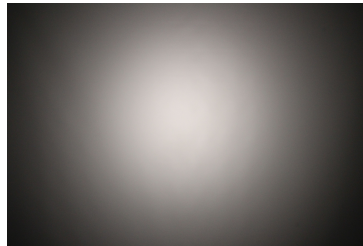

Light distribution files



LED Vesta TW 9mm (12W) CSP
 FWHM / FWTM 30.0° / 69.0°
 Efficiency 75 %
 Peak intensity 1.6 cd/lm
 LEDs/each optic 1
 Light colour/type White

Required components:

- C16142_HEKLA-SOCKET-K
- C13723_MIRELLA-RZL
- Bender Wirth: 489 Typ L8

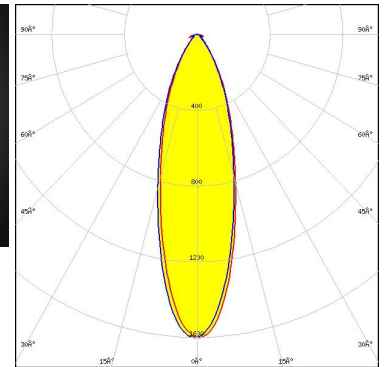
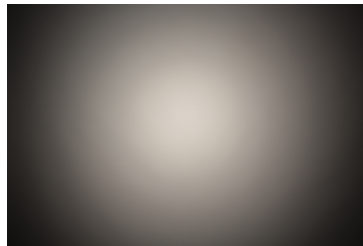

Light distribution files



LED Vesta TW 9mm (12W) CSP
 FWHM / FWTM 30.0° / 69.0°
 Efficiency 75 %
 Peak intensity 1.6 cd/lm
 LEDs/each optic 1
 Light colour/type White

Required components:

- C16142_HEKLA-SOCKET-K
- Bender Wirth: 489 Typ L8

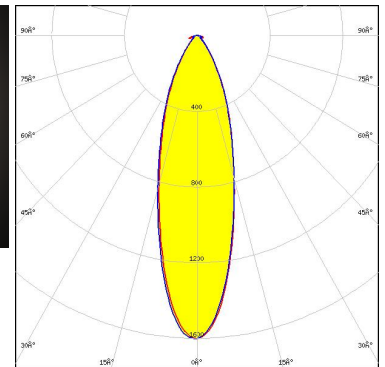
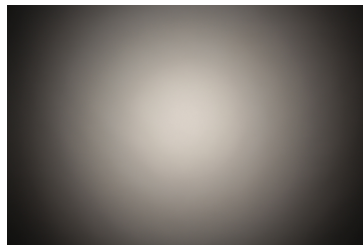

Light distribution files

OPTICAL RESULTS (MEASURED):



LED Vesta TW 9mm (12W) CSP
 FWHM / FWTM 18.0° / 52.0°
 Efficiency 85 %
 Peak intensity 3.8 cd/lm
 LEDs/each optic 1
 Light colour/type White
 Required components:
 C16142_HEKLA-SOCKET-K
 Bender Wirth: 490 Typ L8

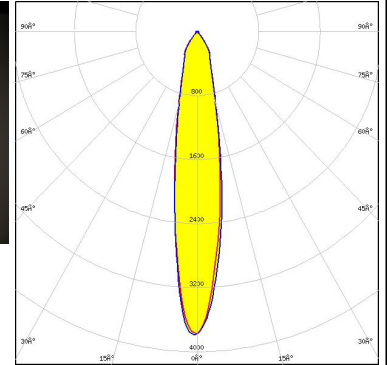

Light distribution files

CITIZEN

LED CLC020 Series (Dim-To-Warm)
 FWHM / FWTM 21.0° / 67.0°
 Efficiency 81 %
 Peak intensity 2.6 cd/lm
 LEDs/each optic 1
 Light colour/type White
 Required components:
 C16142_HEKLA-SOCKET-K

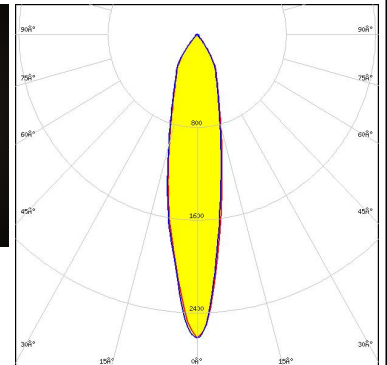
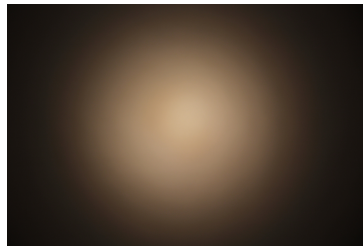

Light distribution files

CITIZEN

LED CLC020 Series (Dim-To-Warm)
 FWHM / FWTM 34.0° / 73.0°
 Efficiency 74 %
 Peak intensity 1.4 cd/lm
 LEDs/each optic 1
 Light colour/type White
 Required components:
 C16142_HEKLA-SOCKET-K
 C13723_MIRELLA-RZL
 Bender Wirth: 487 Typ L8

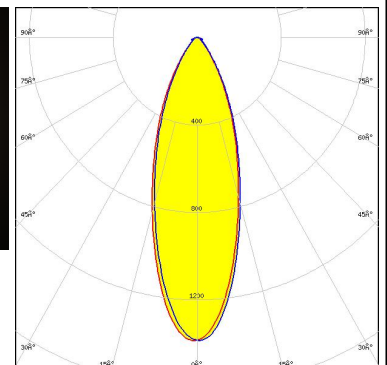
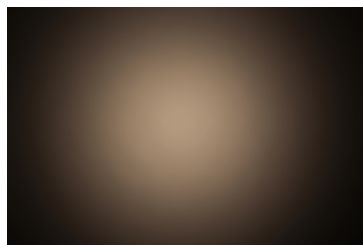

Light distribution files

OPTICAL RESULTS (MEASURED):

CITIZEN

LED CLU025/CLU027 (LES 6)
 FWHM / FWTM 15.0° / 30.0°
 Efficiency 88 %
 Peak intensity 6.6 cd/lm
 LEDs/each optic 1
 Light colour/type White
 Required components:
 F15255_HEKLA-SOCKET-C

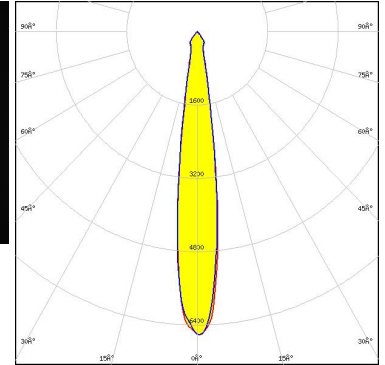
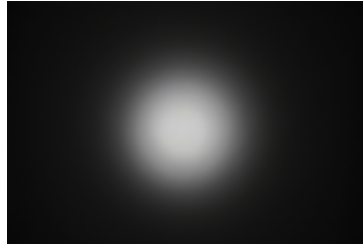

Light distribution files

CITIZEN

LED CLU700/701/702/703
 FWHM / FWTM 13.0° / 25.0°
 Efficiency 91 %
 Peak intensity 8.5 cd/lm
 LEDs/each optic 1
 Light colour/type White
 Required components:
 F15255_HEKLA-SOCKET-C

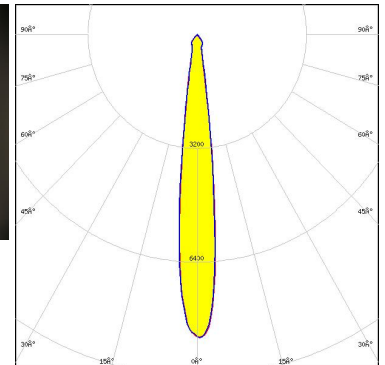

Light distribution files

CITIZEN

LED CLU700/701/702/703
 FWHM / FWTM 13.0° / 26.0°
 Efficiency 92 %
 Peak intensity 8.3 cd/lm
 LEDs/each optic 1
 Light colour/type White
 Required components:
 F15255_HEKLA-SOCKET-C

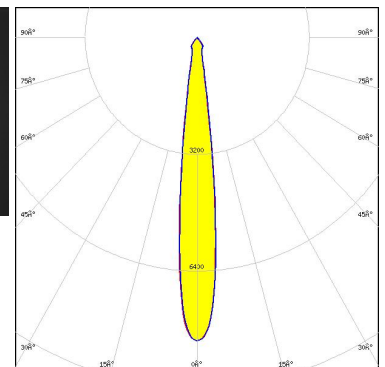
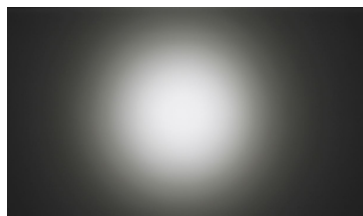

Light distribution files

OPTICAL RESULTS (MEASURED):

CITIZEN

LED CLU710/711
 FWHM / FWTM 19.0° / 61.0°
 Efficiency 86 %
 Peak intensity 3.4 cd/lm
 LEDs/each optic 1
 Light colour/type White
 Required components:
 F15859_HEKLA-SOCKET-I

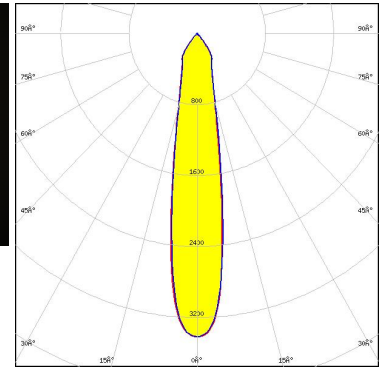
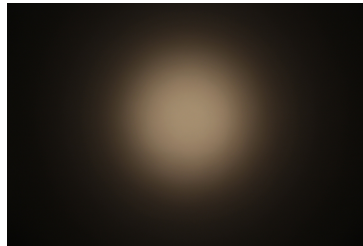

Light distribution files

CITIZEN

LED CLU7A2/7A3
 FWHM / FWTM 9.0° / 20.0°
 Efficiency 89 %
 Peak intensity 11 cd/lm
 LEDs/each optic 1
 Light colour/type White
 Required components:
 F15255_HEKLA-SOCKET-C

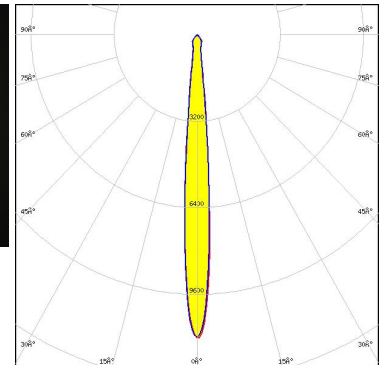

Light distribution files

CITIZEN

LED LCN-C01B (Tunable White)
 FWHM / FWTM 32.0° / 72.0°
 Efficiency 74 %
 Peak intensity 1.4 cd/lm
 LEDs/each optic 1
 Light colour/type White
 Required components:
 C16142_HEKLA-SOCKET-K
 C13723_MIRELLA-RZL
 Bender Wirth: 481 Typ L8

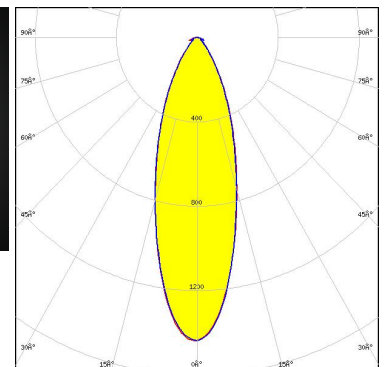
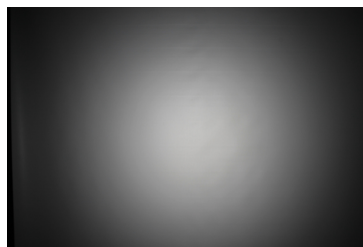

Light distribution files

OPTICAL RESULTS (MEASURED):

CITIZEN

LED LCN-C01B (Tunable White)
 FWHM / FWTM 32.0° / 72.0°
 Efficiency 74 %
 Peak intensity 1.4 cd/lm
 LEDs/each optic 1
 Light colour/type White
 Required components:
 C16142_HEKLA-SOCKET-K
 C13723_MIRELLA-RZL
 Bender Wirth: 481 Typ L8

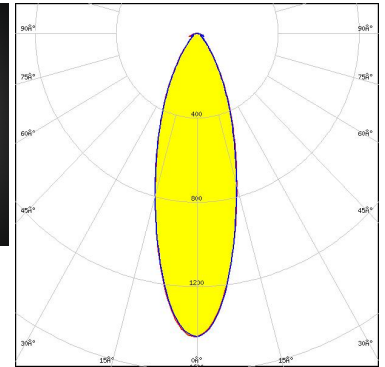

Light distribution files



LED CMA1516
 FWHM / FWTM 21.0° / 65.0°
 Efficiency 88 %
 Peak intensity 3.3 cd/lm
 LEDs/each optic 1
 Light colour/type White
 Required components:
 F15256_HEKLA-SOCKET-D

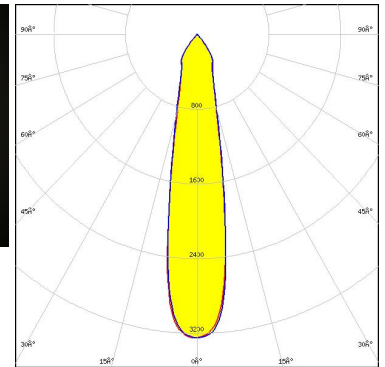
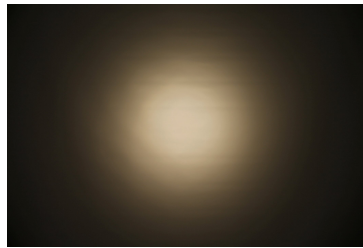

Light distribution files



LED CMT14xx
 FWHM / FWTM 22.0° / 67.0°
 Efficiency 87 %
 Peak intensity 3 cd/lm
 LEDs/each optic 1
 Light colour/type White
 Required components:
 F15255_HEKLA-SOCKET-C

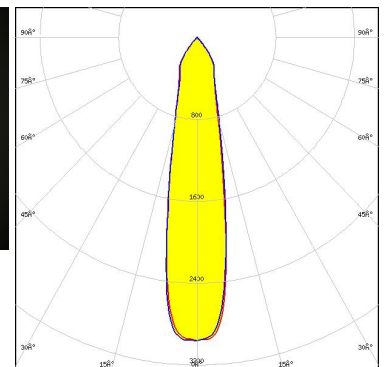
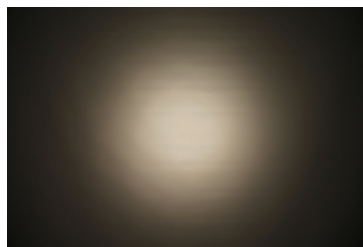

Light distribution files

OPTICAL RESULTS (MEASURED):



LED CXA/B 13xx
 FWHM / FWTM 13.0° / 27.0°
 Efficiency 91 %
 Peak intensity 7.6 cd/lm
 LEDs/each optic 1
 Light colour/type White
 Required components:
 F15956_HEKLA-SOCKET-J

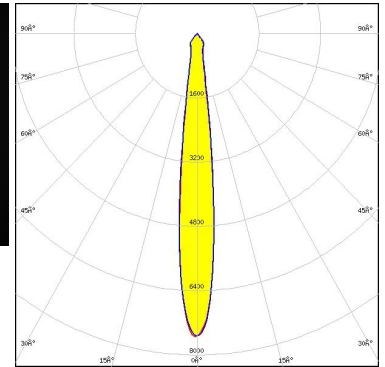
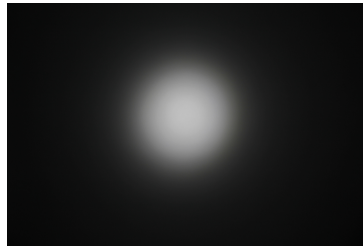

Light distribution files



LED CXA/B 13xx
 FWHM / FWTM 12.0° / 25.0°
 Efficiency 93 %
 Peak intensity 9.2 cd/lm
 LEDs/each optic 1
 Light colour/type White
 Required components:
 F15956_HEKLA-SOCKET-J
 C13723_MIRELLA-RZL

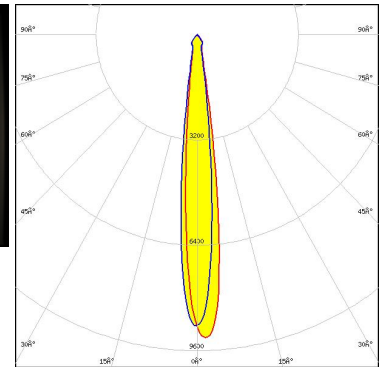

Light distribution files



LED CXA/B 15xx
 FWHM / FWTM 18.0° / 40.0°
 Efficiency 93 %
 Peak intensity 4.8 cd/lm
 LEDs/each optic 1
 Light colour/type White
 Required components:
 F15256_HEKLA-SOCKET-D

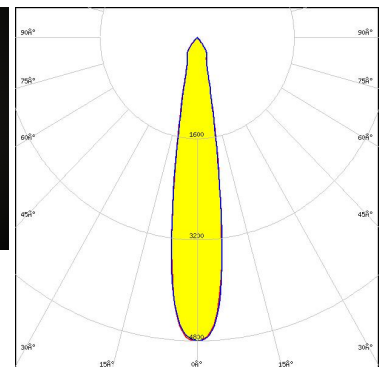

Light distribution files

OPTICAL RESULTS (MEASURED):



LED LUXEON CoB 1202/1203
FWHM / FWTM 19.0° / 44.0°
Efficiency 90 %
Peak intensity 4.3 cd/lm
LEDs/each optic 1
Light colour/type White
Required components:
 F15858_HEKLA-SOCKET-H

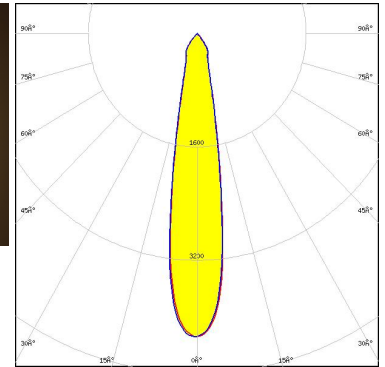
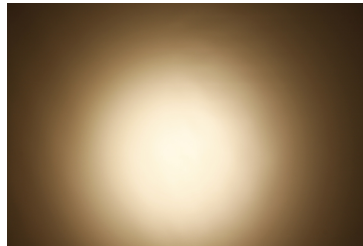

Light distribution files



LED LUXEON CoB 1202HD
FWHM / FWTM 15.0° / 33.0°
Efficiency 87 %
LEDs/each optic 1
Light colour/type White
Required components:
 F15848_HEKLA-SOCKET-G

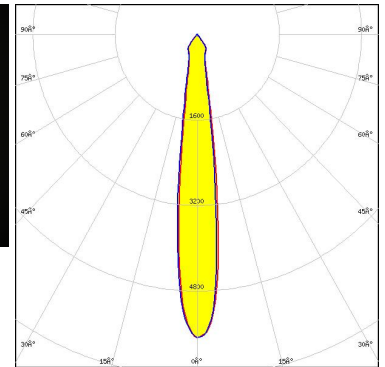
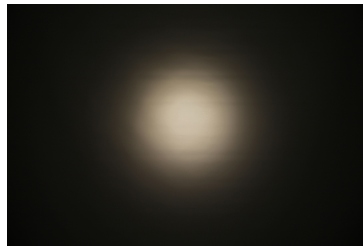

Light distribution files



LED LUXEON CoB 1204HD
FWHM / FWTM 20.0° / 62.0°
Efficiency 88 %
Peak intensity 3.4 cd/lm
LEDs/each optic 1
Light colour/type White
Required components:
 F15858_HEKLA-SOCKET-H

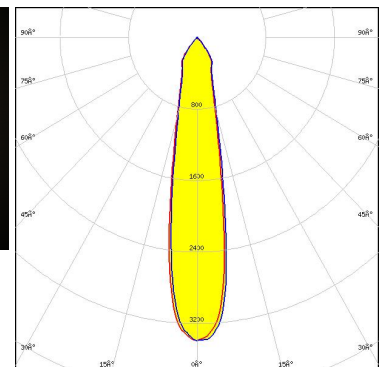
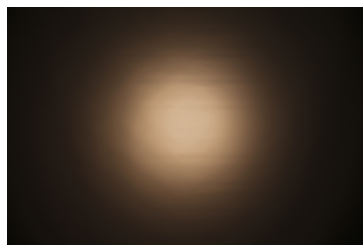

Light distribution files

OPTICAL RESULTS (MEASURED):



LED LUXEON CoB 1205HD
 FWHM / FWTM 25.0° / 71.0°
 Efficiency 85 %
 Peak intensity 2.4 cd/lm
 LEDs/each optic 1
 Light colour/type White
 Required components:
 F15858_HEKLA-SOCKET-H

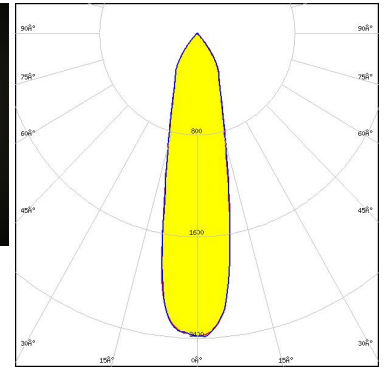
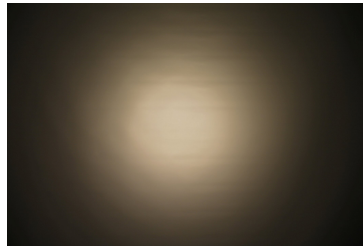

Light distribution files



LED LUXEON CX Plus CoB - HD S01H4
 FWHM / FWTM 28.0° / 72.0°
 Efficiency 73 %
 Peak intensity 1.6 cd/lm
 LEDs/each optic 1
 Light colour/type White
 Required components:
 C13723_MIRELLA-RZL
 Bender Wirth: 634c Hekla

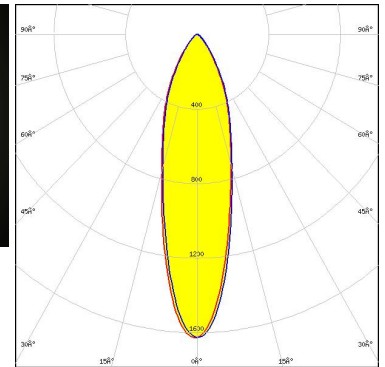
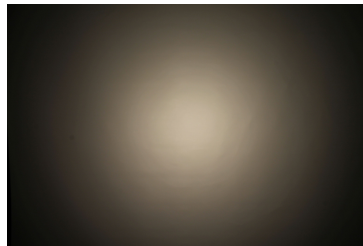

Light distribution files



LED LUXEON CX Plus CoB - HD S01H4
 FWHM / FWTM 13.0° / 51.0°
 Efficiency 81 %
 Peak intensity 4.2 cd/lm
 LEDs/each optic 1
 Light colour/type White
 Required components:
 Bender Wirth: 634c Hekla

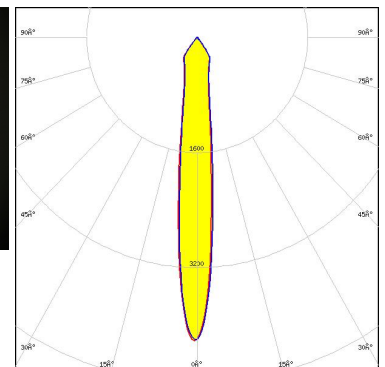
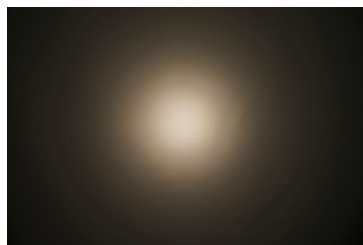

Light distribution files

OPTICAL RESULTS (MEASURED):

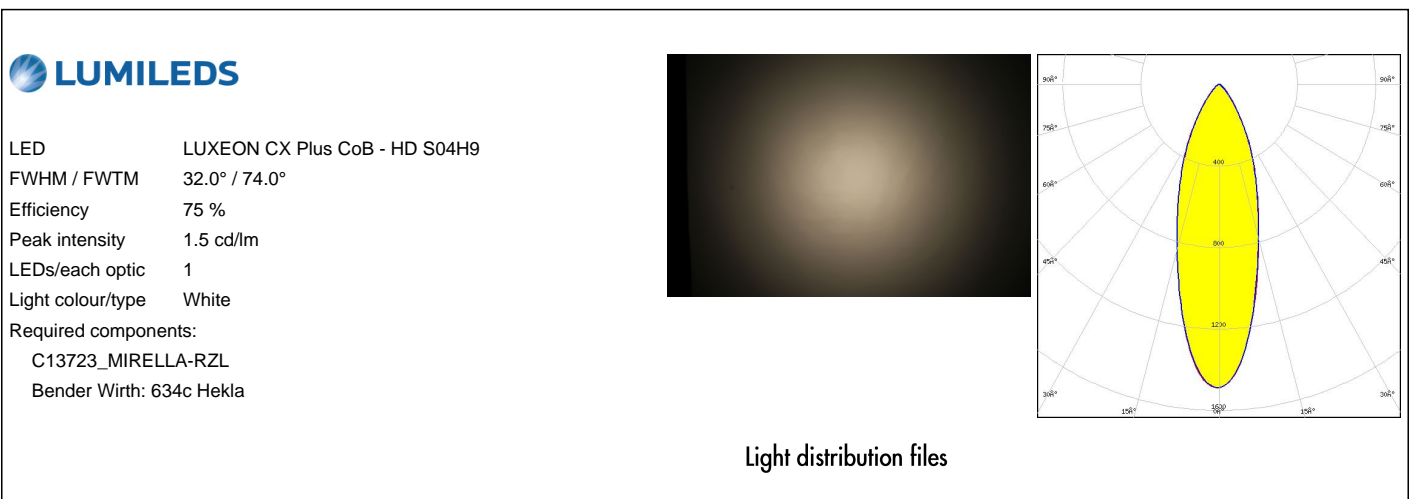
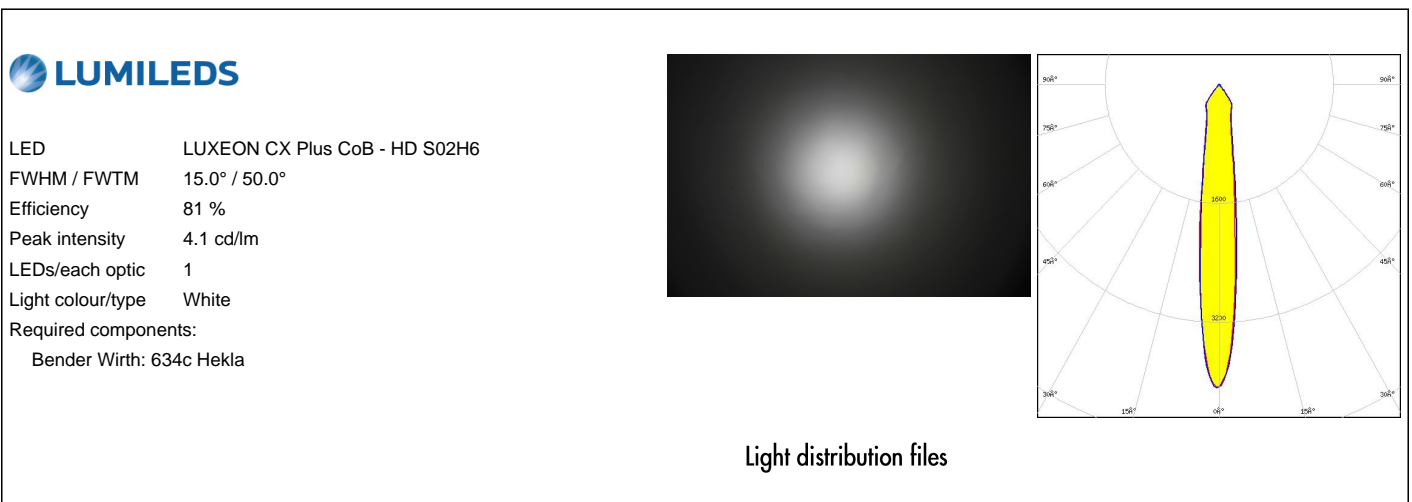
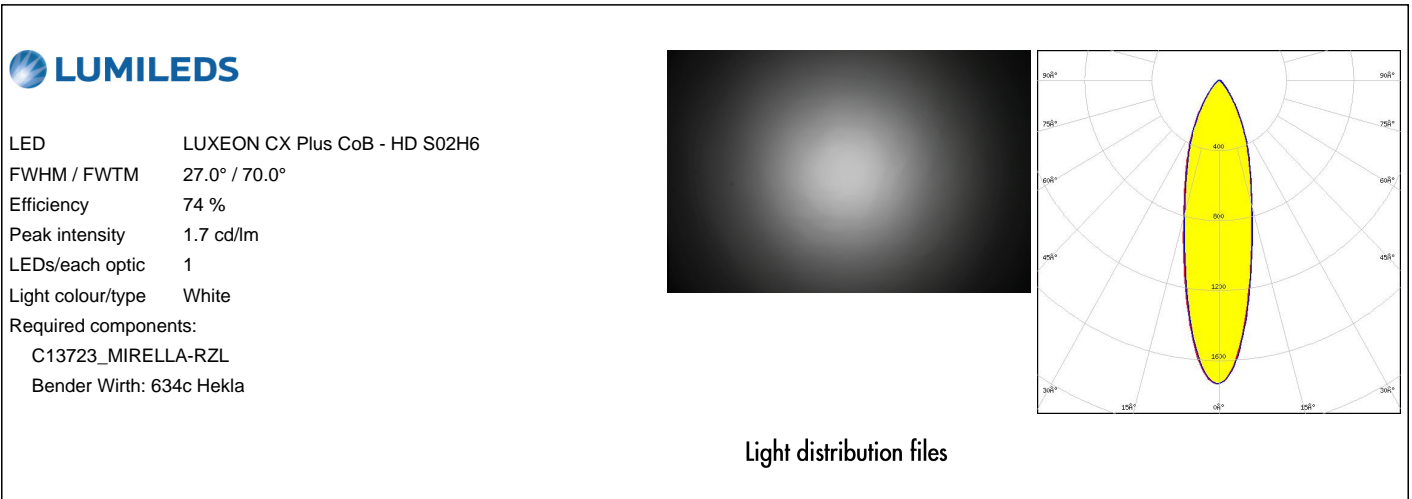

OPTICAL RESULTS (MEASURED):



LED LUXEON CX Plus CoB - HD S04H9
 FWHM / FWTM 21.0° / 71.0°
 Efficiency 82 %
 Peak intensity 2.6 cd/lm
 LEDs/each optic 1
 Light colour/type White
 Required components:
 Bender Wirth: 634c Hekla

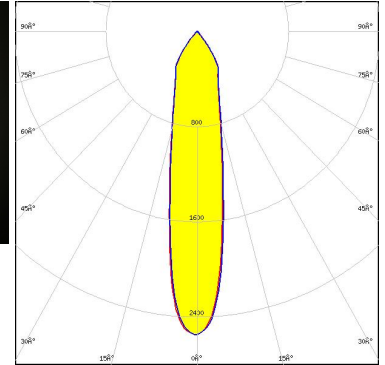

Light distribution files



LED LUXEON CX Plus CoB L04 / L05 (Gen2)
 FWHM / FWTM 26.0° / 74.0°
 Efficiency 80 %
 Peak intensity 1.9 cd/lm
 LEDs/each optic 1
 Light colour/type White
 Required components:
 Bender Wirth: 637a Hekla

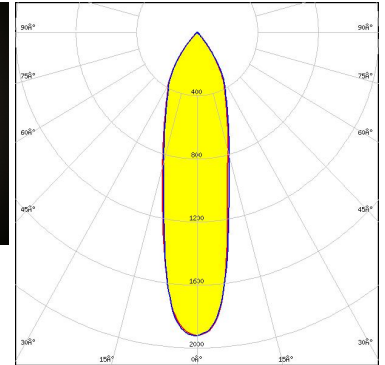

Light distribution files



LED LUXEON CX Plus CoB L04 / L05 (Gen2)
 FWHM / FWTM 38.0° / 77.0°
 Efficiency 72 %
 Peak intensity 1.2 cd/lm
 LEDs/each optic 1
 Light colour/type White
 Required components:
 C13723_MIRELLA-RZL
 Bender Wirth: 637a Hekla

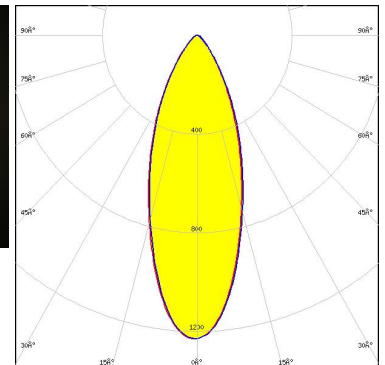
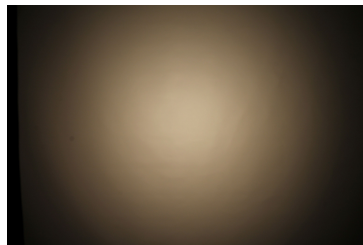

Light distribution files

OPTICAL RESULTS (MEASURED):



LED LUXEON CX Plus CoB M02 / M03 (Gen2)
FWHM / FWTM 19.0° / 70.0°
Efficiency 80 %
Peak intensity 2.7 cd/lm
LEDs/each optic 1
Light colour/type White
Required components:
Bender Wirth: 641a Hekla

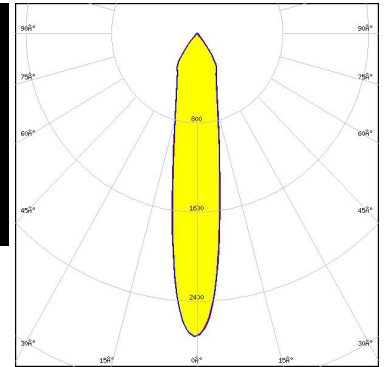

Light distribution files



LED LUXEON CX Plus CoB M02 / M03 (Gen2)
FWHM / FWTM 33.0° / 75.0°
Efficiency 72 %
Peak intensity 1.4 cd/lm
LEDs/each optic 1
Light colour/type White
Required components:
C13723_MIRELLA-RZL
Bender Wirth: 641a Hekla

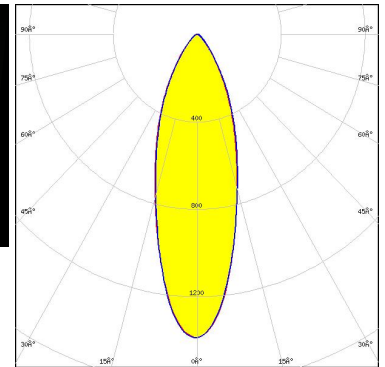
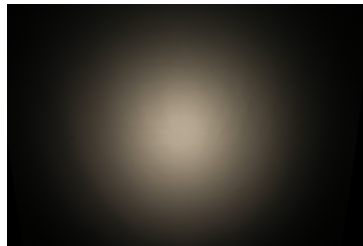

Light distribution files



LED LUXEON CX Plus CoB S01 (Gen2)
FWHM / FWTM 13.0° / 37.0°
Efficiency 82 %
Peak intensity 5.1 cd/lm
LEDs/each optic 1
Light colour/type White
Required components:
Bender Wirth: 634c Hekla

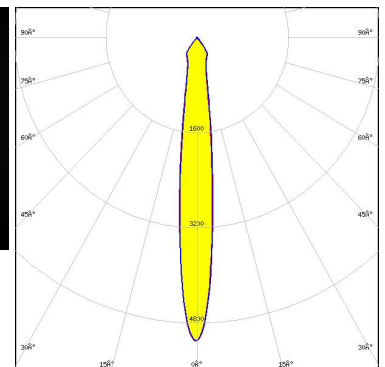
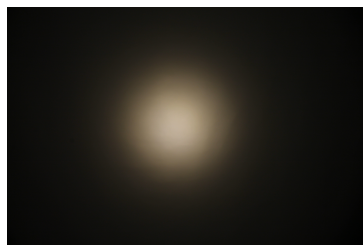

Light distribution files

OPTICAL RESULTS (MEASURED):



LED LUXEON CX Plus CoB S01 (Gen2)
 FWHM / FWTM 25.0° / 68.0°
 Efficiency 74 %
 Peak intensity 1.9 cd/lm
 LEDs/each optic 1
 Light colour/type White
 Required components:
 C13723_MIRELLA-RZL
 Bender Wirth: 634c Hekla

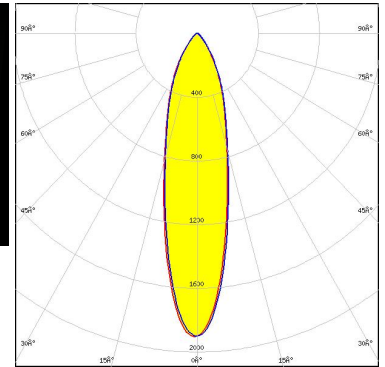

Light distribution files



LED CDM-6 (Dim-To-Warm)
 FWHM / FWTM 28.0° / 69.0°
 Efficiency 74 %
 Peak intensity 1.7 cd/lm
 LEDs/each optic 1
 Light colour/type White
 Required components:
 C16142_HEKLA-SOCKET-K
 C13723_MIRELLA-RZL
 Bender Wirth: 490 Typ L8

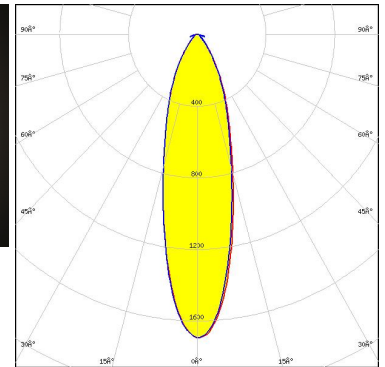
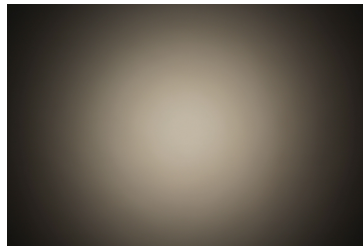

Light distribution files



LED CDM-9 (Dim-To-Warm)
 FWHM / FWTM 20.0° / 65.0°
 Efficiency 80 %
 Peak intensity 2.9 cd/lm
 LEDs/each optic 1
 Light colour/type White
 Required components:
 C16142_HEKLA-SOCKET-K
 Bender Wirth: 490 Typ L8

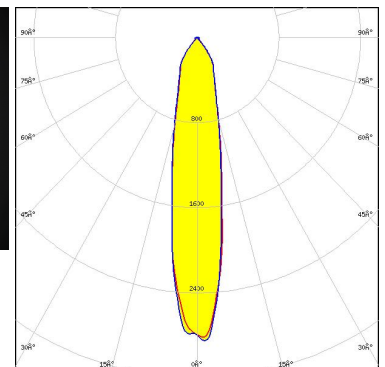

Light distribution files

OPTICAL RESULTS (MEASURED):

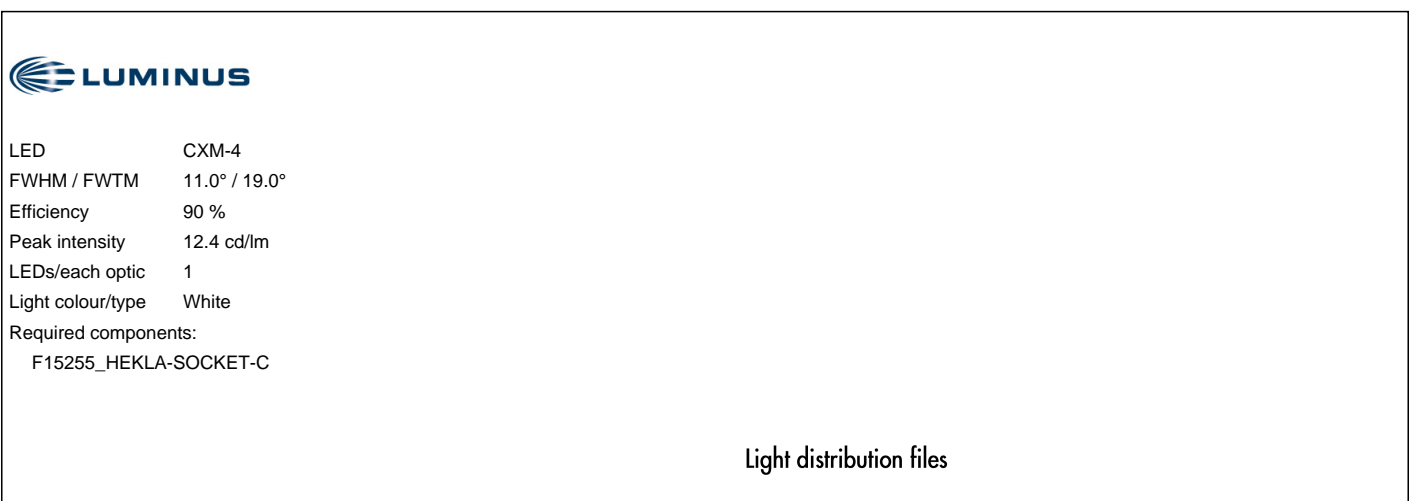
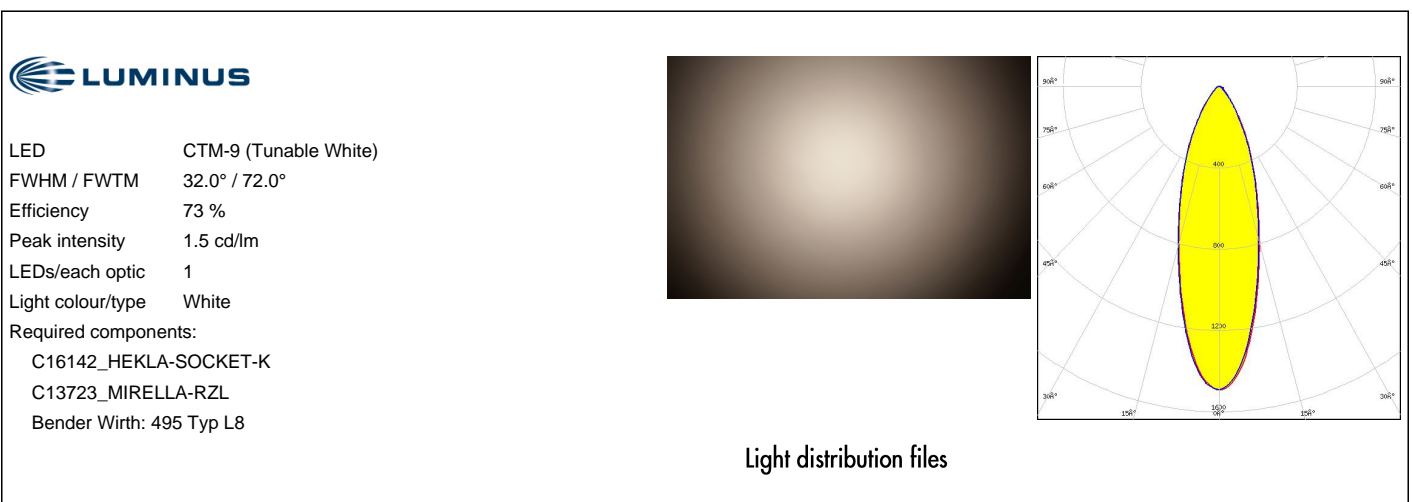
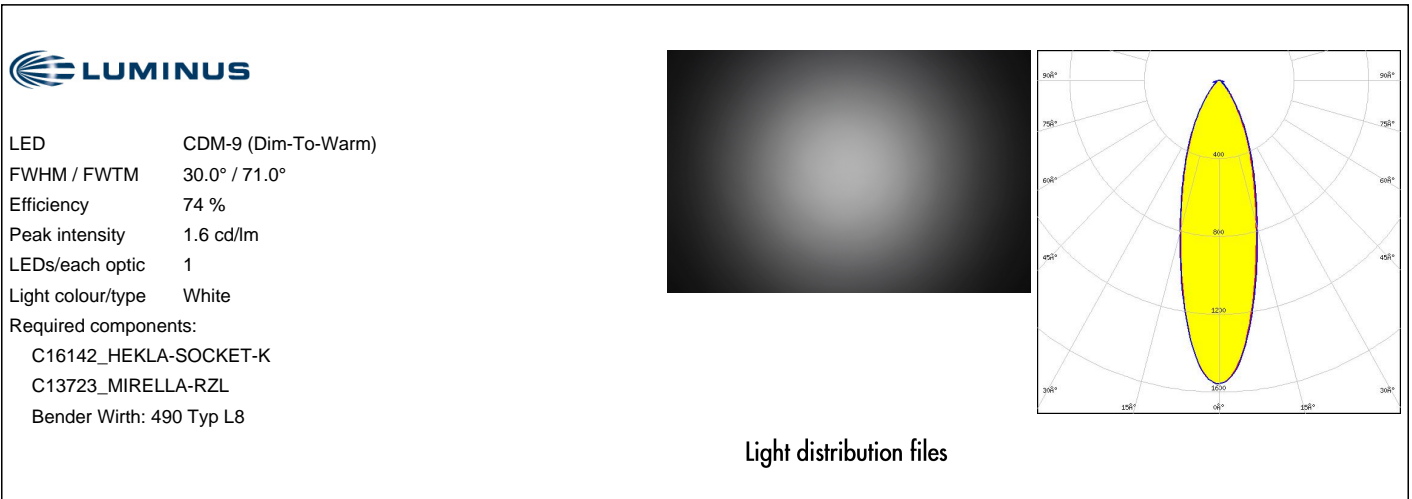

OPTICAL RESULTS (MEASURED):



LED CXM-4
FWHM / FWTM 21.0° / 57.0°
Efficiency 83 %
Peak intensity 2.9 cd/lm
LEDs/each optic 1
Light colour/type White
Required components:
 F15255_HEKLA-SOCKET-C
 C13723_MIRELLA-RZL

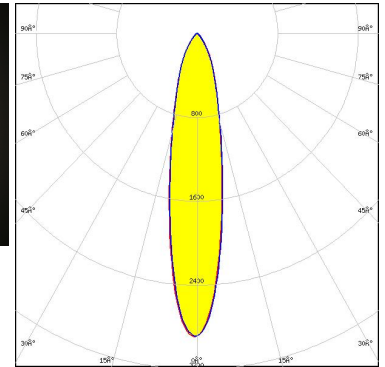

Light distribution files



LED CxM-9 (13.5x13.5)
FWHM / FWTM 22.0° / 67.0°
Efficiency 88 %
Peak intensity 3 cd/lm
LEDs/each optic 1
Light colour/type White
Required components:
 F15255_HEKLA-SOCKET-C

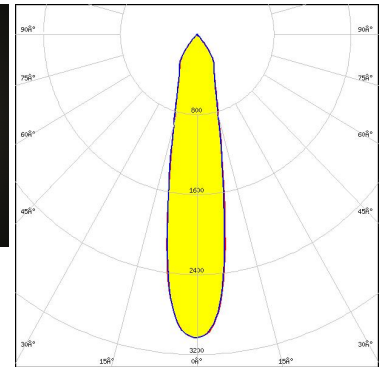

Light distribution files



LED NJCWL024Z-V1MT: COB L-Type Tunable White
FWHM / FWTM 30.0° / 69.0°
Efficiency 73 %
Peak intensity 1.6 cd/lm
LEDs/each optic 1
Light colour/type White
Required components:
 C16142_HEKLA-SOCKET-K
 C13723_MIRELLA-RZL
 Bender Wirth: 497 Typ L8

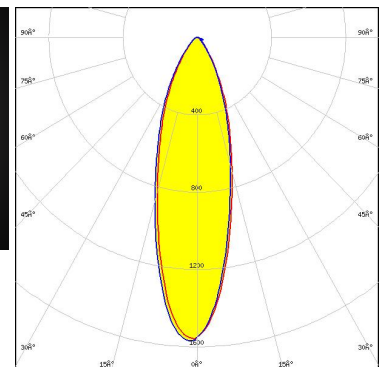
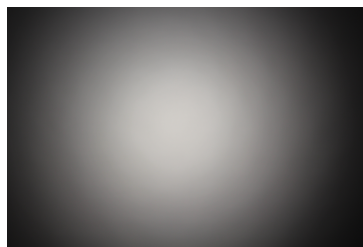

Light distribution files

OPTICAL RESULTS (MEASURED):



LED NVCWJ024Z-V1MT: COB J-Type Tunable White
FWHM / FWTM 34.0° / 73.0°
Efficiency 74 %
Peak intensity 1.4 cd/lm
LEDs/each optic 1
Light colour/type White
Required components:
 C16142_HEKLA-SOCKET-K
 C13723_MIRELLA-RZL
 Bender Wirth: 498 Typ L8

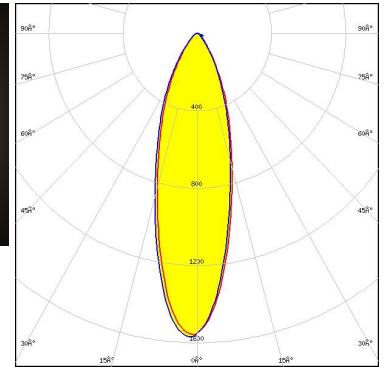
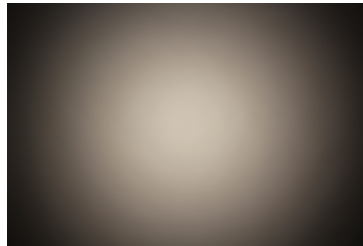

Light distribution files



LED Soleriq S9
FWHM / FWTM 21.0° / 51.0°
Efficiency 91 %
Peak intensity 3.8 cd/lm
LEDs/each optic 1
Light colour/type White
Required components:
 F15255_HEKLA-SOCKET-C
 C12479_MIRELLA-DL

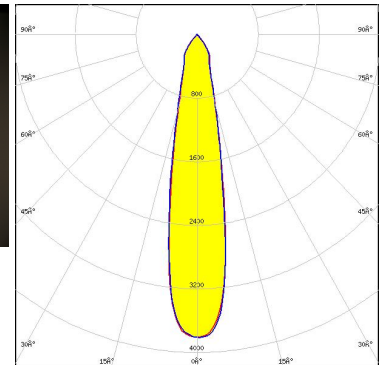

Light distribution files



LED Fortimo SLM L09 CoB
FWHM / FWTM 30.0° / 71.0°
Efficiency 78 %
Peak intensity 1.7 cd/lm
LEDs/each optic 1
Light colour/type White
Required components:
 F15858_HEKLA-SOCKET-H
 C13723_MIRELLA-RZL

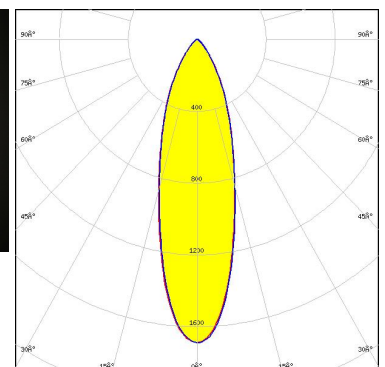
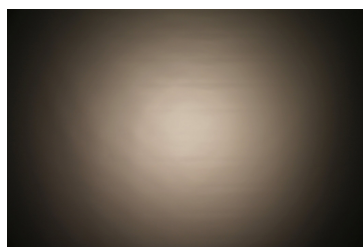

Light distribution files

OPTICAL RESULTS (MEASURED):

PHILIPS

LED Fortimo SLM L09 CoB
 FWHM / FWTM 20.0° / 67.0°
 Efficiency 85 %
 Peak intensity 3 cd/lm
 LEDs/each optic 1
 Light colour/type White
 Required components:
 F15858_HEKLA-SOCKET-H

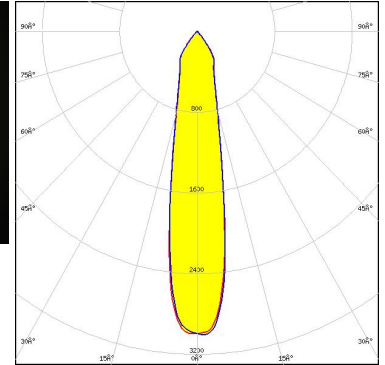

Light distribution files

PHILIPS

LED Fortimo SLM L13 CoB
 FWHM / FWTM 39.0° / 78.0°
 Efficiency 72 %
 Peak intensity 1.2 cd/lm
 LEDs/each optic 1
 Light colour/type White
 Required components:
 C16142_HEKLA-SOCKET-K
 C13723_MIRELLA-RZL
 Bender Wirth: 432 Typ L8

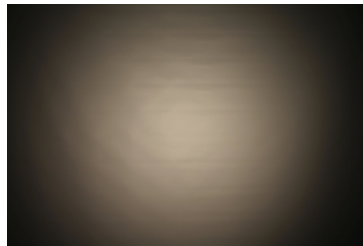

Light distribution files

PHILIPS

LED Fortimo SLM L13 CoB
 FWHM / FWTM 39.0° / 78.0°
 Efficiency 72 %
 Peak intensity 1.2 cd/lm
 LEDs/each optic 1
 Light colour/type White
 Required components:
 C16142_HEKLA-SOCKET-K
 C13723_MIRELLA-RZL
 Bender Wirth: 432 Typ L8

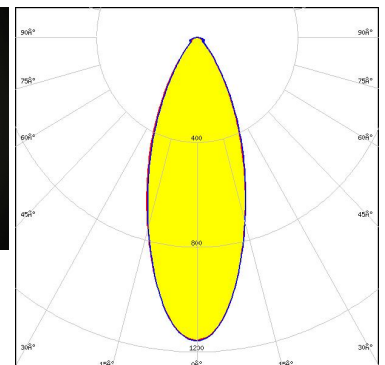
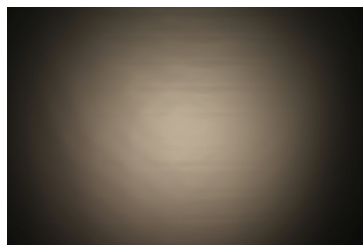

Light distribution files

OPTICAL RESULTS (MEASURED):

PHILIPS

LED Fortimo SLM L13 CoB
 FWHM / FWTM 30.0° / 75.0°
 Efficiency 78 %
 Peak intensity 1.6 cd/lm
 LEDs/each optic 1
 Light colour/type White
 Required components:
 C16142_HEKLA-SOCKET-K
 Bender Wirth: 432 Typ L8

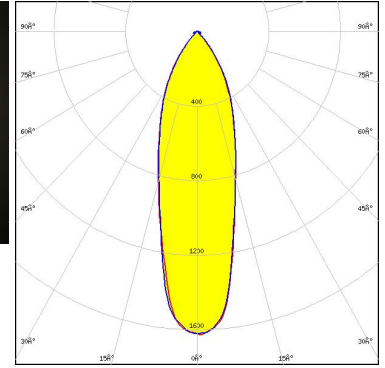

Light distribution files

PHILIPS

LED Fortimo SLM L13 CoB
 FWHM / FWTM 30.0° / 75.0°
 Efficiency 78 %
 Peak intensity 1.6 cd/lm
 LEDs/each optic 1
 Light colour/type White
 Required components:
 C16142_HEKLA-SOCKET-K
 Bender Wirth: 432 Typ L8

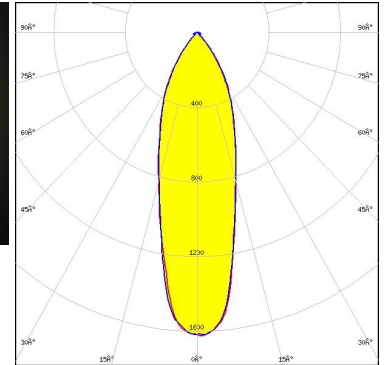

Light distribution files

SAMSUNG

LED LC010C G2
 FWHM / FWTM 13.0° / 31.0°
 Efficiency 88 %
 Peak intensity 6.4 cd/lm
 LEDs/each optic 1
 Light colour/type White
 Required components:
 F15255_HEKLA-SOCKET-C

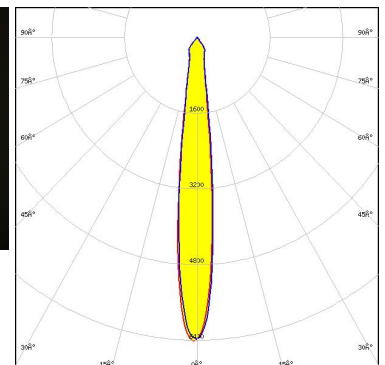

Light distribution files

OPTICAL RESULTS (MEASURED):

SAMSUNG

LED LC010T (Tunable White)
 FWHM / FWTM 19.0° / 59.0°
 Efficiency 78 %
 Peak intensity 3.1 cd/lm
 LEDs/each optic 1
 Light colour/type Tunable White
 Required components:
 C16142_HEKLA-SOCKET-K
 C14658_BARBARA-RZ-LENS
 Bender Wirth: 501 Typ L8

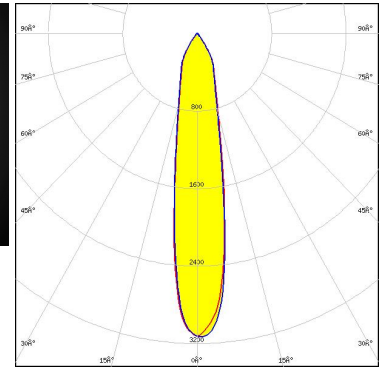

Light distribution files

SAMSUNG

LED LC010T (Tunable White)
 FWHM / FWTM 19.0° / 61.0°
 Efficiency 83 %
 Peak intensity 3.3 cd/lm
 LEDs/each optic 1
 Light colour/type Tunable White
 Required components:
 C16142_HEKLA-SOCKET-K
 Bender Wirth: 501 Typ L8

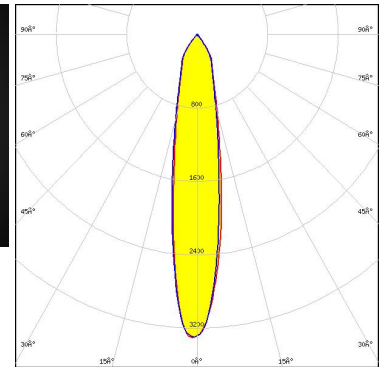

Light distribution files

SAMSUNG

LED LC016D / LC019D / LC026D / LC033D
 FWHM / FWTM 41.0° / 80.0°
 Efficiency 75 %
 Peak intensity 1.2 cd/lm
 LEDs/each optic 1
 Light colour/type White
 Required components:
 F15859_HEKLA-SOCKET-I
 C13723_MIRELLA-RZL

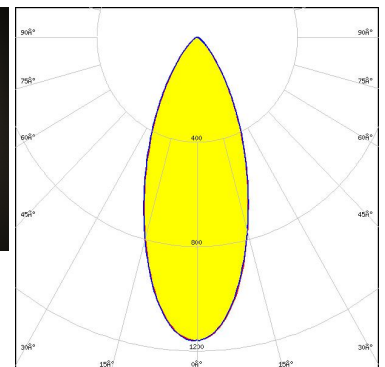
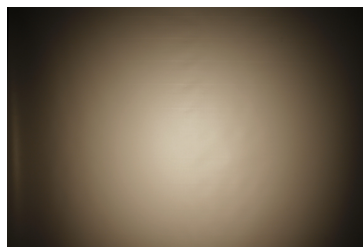

Light distribution files

OPTICAL RESULTS (MEASURED):

SAMSUNG

LED LC016D / LC019D / LC026D / LC033D
FWHM / FWTM 37.0° / 75.0°
Efficiency 79 %
Peak intensity 1.5 cd/lm
LEDs/each optic 1
Light colour/type White
Required components:
F15859_HEKLA-SOCKET-I
C13333_MIRELLA-CL

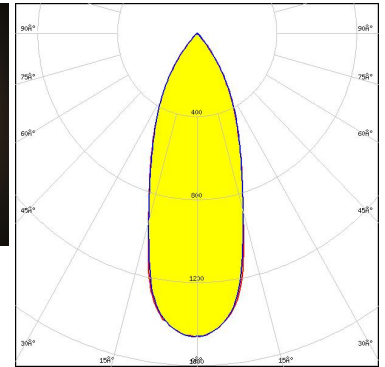
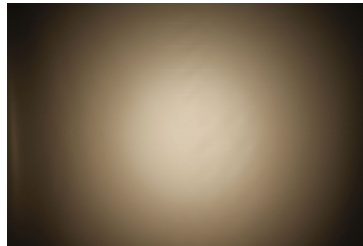

Light distribution files

SAMSUNG

LED LC016D / LC019D / LC026D / LC033D
FWHM / FWTM 35.0° / 77.0°
Efficiency 84 %
Peak intensity 1.6 cd/lm
LEDs/each optic 1
Light colour/type White
Required components:
F15859_HEKLA-SOCKET-I

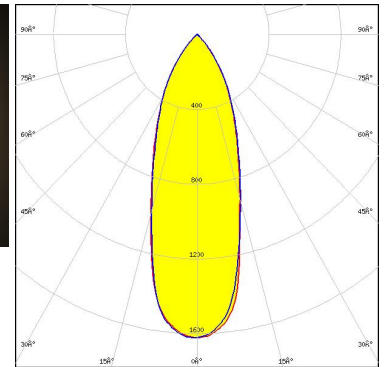
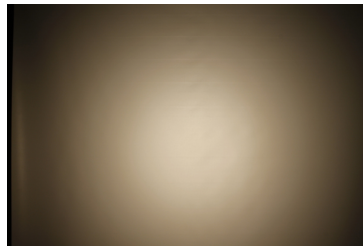

Light distribution files

SAMSUNG

LED LC016D / LC019D / LC026D / LC033D
FWHM / FWTM 39.0° / 76.0°
Efficiency 77 %
Peak intensity 1.3 cd/lm
LEDs/each optic 1
Light colour/type White
Required components:
F15859_HEKLA-SOCKET-I
C12479_MIRELLA-DL

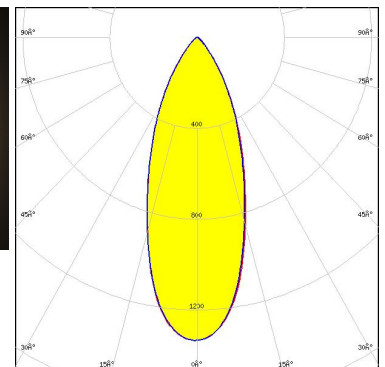
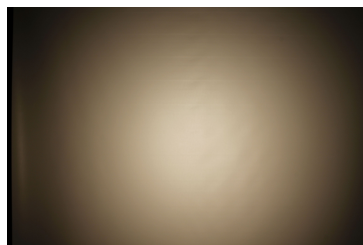

Light distribution files

OPTICAL RESULTS (MEASURED):

SAMSUNG

LED LC020C
FWHM / FWTM 18.0° / 44.0°
Efficiency 90 %
Peak intensity 4.4 cd/lm
LEDs/each optic 1
Light colour/type White
Required components:
F15848_HEKLA-SOCKET-G

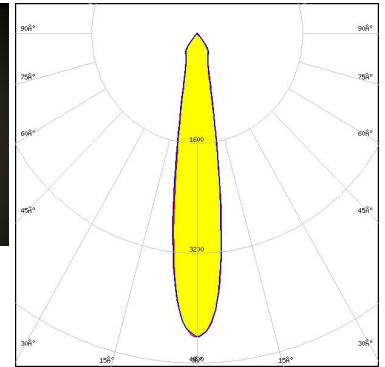

Light distribution files

SAMSUNG

LED LC020C G2
FWHM / FWTM 20.0° / 62.0°
Efficiency 86 %
Peak intensity 3.4 cd/lm
LEDs/each optic 1
Light colour/type White
Required components:
F15859_HEKLA-SOCKET-I

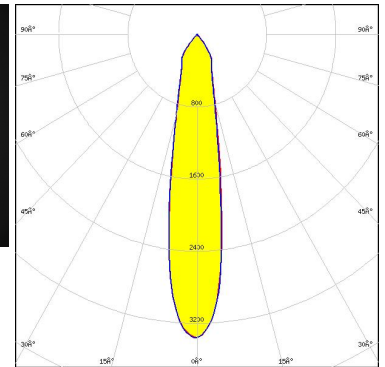
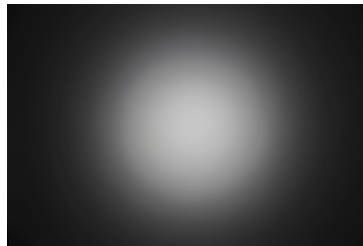

Light distribution files

TRIDONIC

LED SLE G7 LES09
FWHM / FWTM 30.0° / 71.0°
Efficiency 83 %
Peak intensity 1.8 cd/lm
LEDs/each optic 1
Light colour/type White
Required components:
F15255_HEKLA-SOCKET-C
C13723_MIRELLA-RZL

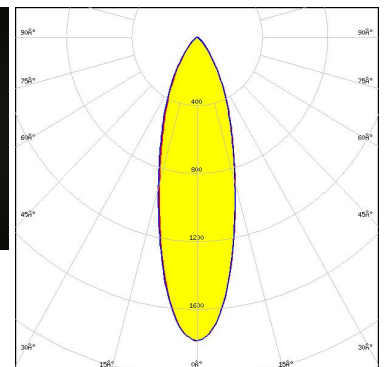
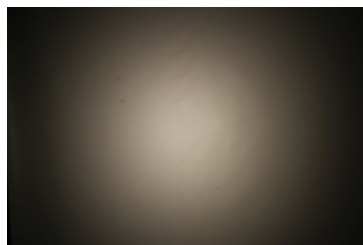

Light distribution files

OPTICAL RESULTS (MEASURED):

TRIDONIC

LED SLE G7 LES09
 FWHM / FWTM 21.0° / 66.0°
 Efficiency 90 %
 Peak intensity 3.3 cd/lm
 LEDs/each optic 1
 Light colour/type White
 Required components:
 F15255_HEKLA-SOCKET-C

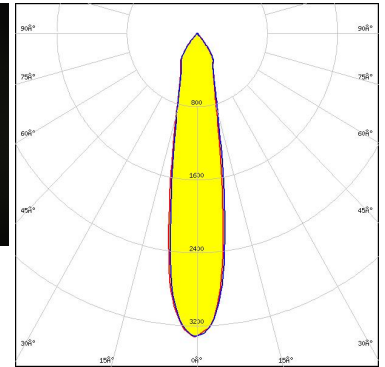

Light distribution files

TRIDONIC

LED SLE G7 LES13
 FWHM / FWTM 39.0° / 79.0°
 Efficiency 76 %
 Peak intensity 1.2 cd/lm
 LEDs/each optic 1
 Light colour/type White
 Required components:
 F15859_HEKLA-SOCKET-I
 C13723_MIRELLA-RZL

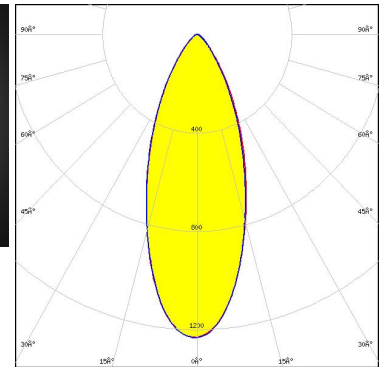
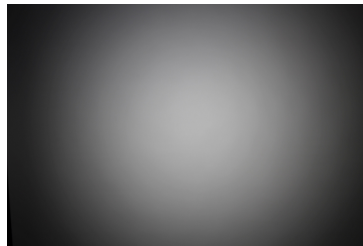

Light distribution files

TRIDONIC

LED SLE G7 LES13
 FWHM / FWTM 31.0° / 76.0°
 Efficiency 84 %
 Peak intensity 1.8 cd/lm
 LEDs/each optic 1
 Light colour/type White
 Required components:
 F15859_HEKLA-SOCKET-I

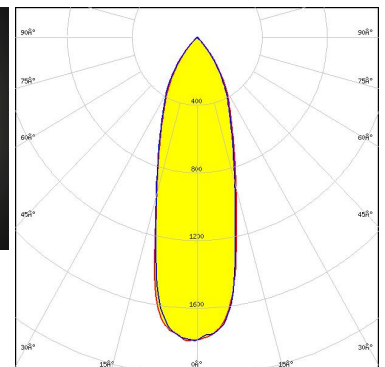
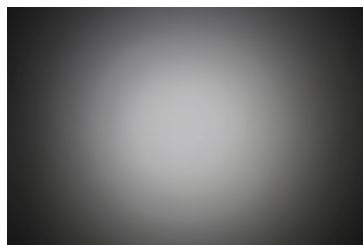

Light distribution files

OPTICAL RESULTS (MEASURED):

XICATO

LED XOB 14.5 mm
FWHM / FWTM 38.0° / 77.0°
Efficiency 78 %
Peak intensity 1.4 cd/lm
LEDs/each optic 1
Light colour/type White
Required components:
F15859_HEKLA-SOCKET-I
C13723_MIRELLA-RZL

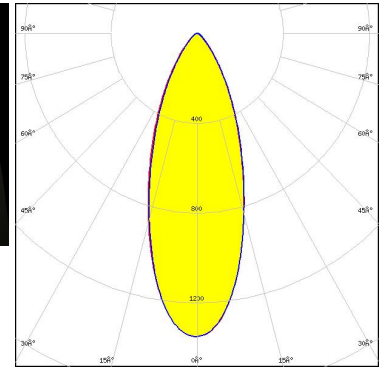

Light distribution files

XICATO

LED XOB 14.5 mm
FWHM / FWTM 31.0° / 74.0°
Efficiency 86 %
Peak intensity 1.9 cd/lm
LEDs/each optic 1
Light colour/type White
Required components:
F15859_HEKLA-SOCKET-I

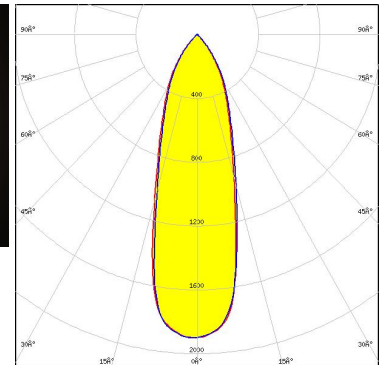
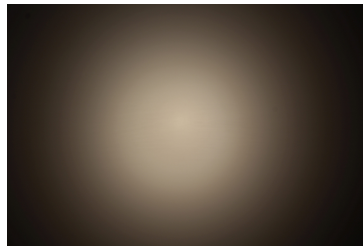

Light distribution files

XICATO

LED XOB 6 mm
FWHM / FWTM 14.0° / 34.0°
Efficiency 87 %
Peak intensity 5.6 cd/lm
LEDs/each optic 1
Light colour/type White
Required components:
F15255_HEKLA-SOCKET-C

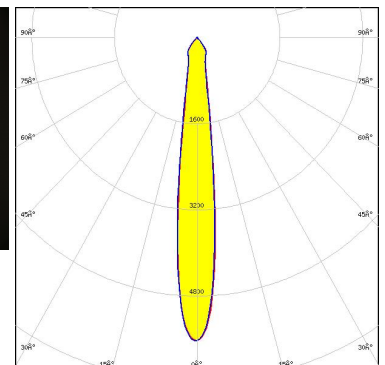

Light distribution files

OPTICAL RESULTS (MEASURED):

XICATO

LED XOB 6 mm
 FWHM / FWTM 25.0° / 66.0°
 Efficiency 80 %
 Peak intensity 2.1 cd/lm
 LEDs/each optic 1
 Light colour/type White
 Required components:
 F15255_HEKLA-SOCKET-C
 C13723_MIRELLA-RZL

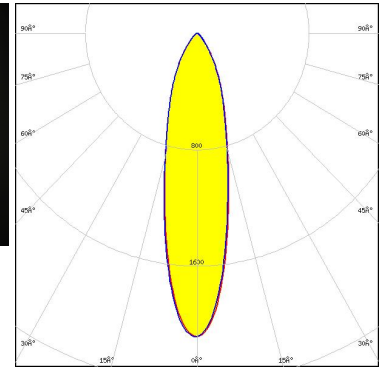
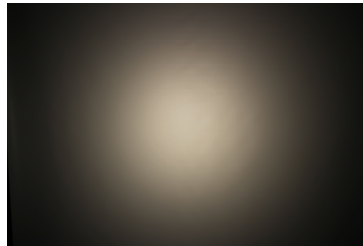

Light distribution files

XICATO

LED XOB 9.8 mm
 FWHM / FWTM 28.0° / 67.0°
 Efficiency 84 %
 Peak intensity 2.1 cd/lm
 LEDs/each optic 1
 Light colour/type White
 Required components:
 F15255_HEKLA-SOCKET-C
 C13723_MIRELLA-RZL

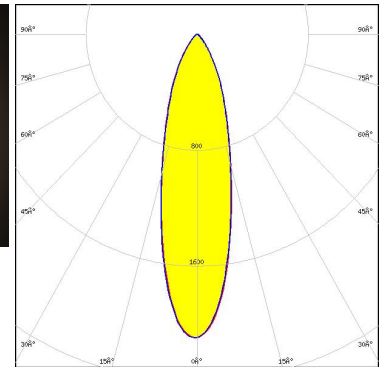
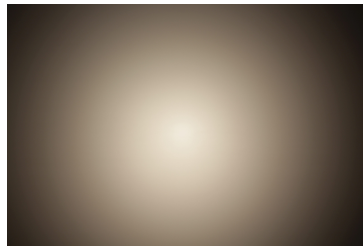

Light distribution files

XICATO

LED XOB 9.8 mm
 FWHM / FWTM 19.0° / 46.0°
 Efficiency 91 %
 Peak intensity 4.2 cd/lm
 LEDs/each optic 1
 Light colour/type White
 Required components:
 F15255_HEKLA-SOCKET-C

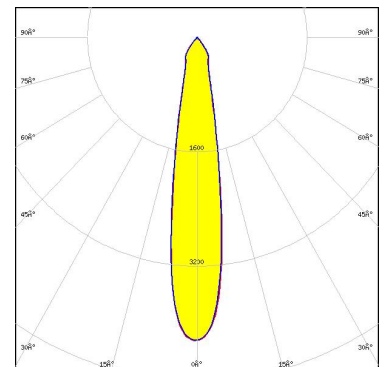

Light distribution files

OPTICAL RESULTS (SIMULATED):



LED VERO13
FWHM / FWTM 25.0° / 66.0°
Efficiency 82 %
Peak intensity 2.3 cd/lm
LEDs/each optic 1
Light colour/type White
Required components:
 C16142_HEKLA-SOCKET-K

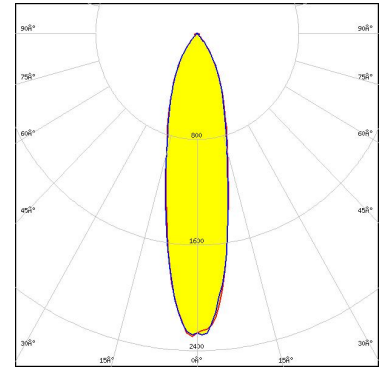

Light distribution files

CITIZEN

LED CLL02x/CLU02x (LES10)
FWHM / FWTM 20.0° / 47.7°
Efficiency 86 %
Peak intensity 3.9 cd/lm
LEDs/each optic 1
Light colour/type White
Required components:
 F15255_HEKLA-SOCKET-C

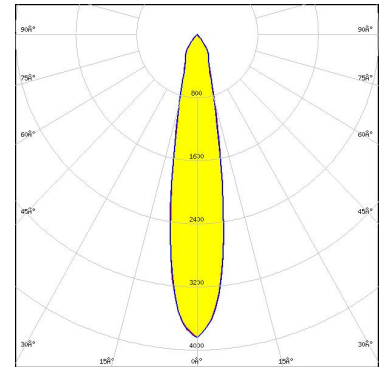

Light distribution files



LED CMA1516
FWHM / FWTM 19.0° / 45.0°
Efficiency 89 %
Peak intensity 4.2 cd/lm
LEDs/each optic 1
Light colour/type White
Required components:
 F15256_HEKLA-SOCKET-D

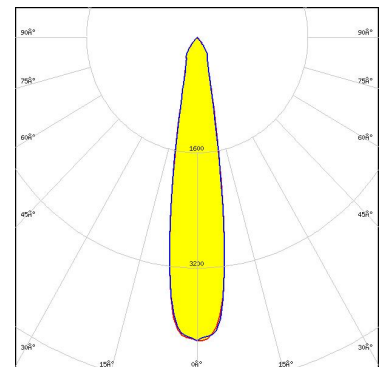

Light distribution files

OPTICAL RESULTS (SIMULATED):



LED CMT14xx
FWHM / FWTM 21.0° / 47.0°
Efficiency 86 %
Peak intensity 3.8 cd/lm
LEDs/each optic 1
Light colour/type White
Required components:
 F15255_HEKLA-SOCKET-C

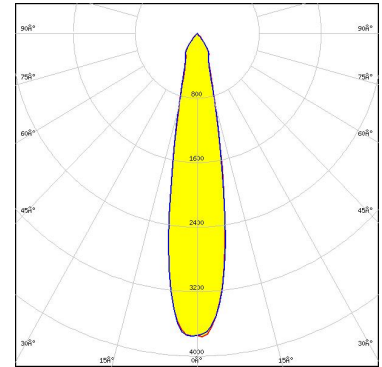

Light distribution files



LED COB L-Type (LES 11)
FWHM / FWTM 23.0° / 63.0°
Efficiency 88 %
Peak intensity 2.9 cd/lm
LEDs/each optic 1
Light colour/type White
Required components:
 F15858_HEKLA-SOCKET-H

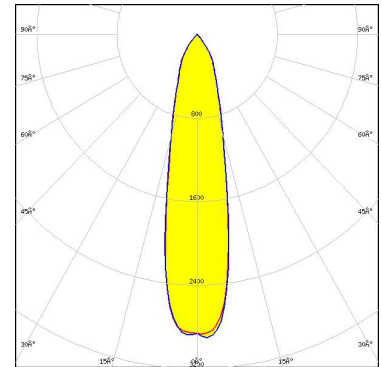

Light distribution files



LED COB T-Type
FWHM / FWTM 14.0° / 29.0°
Efficiency 88 %
Peak intensity 7.4 cd/lm
LEDs/each optic 1
Light colour/type White
Required components:
 F15848_HEKLA-SOCKET-G

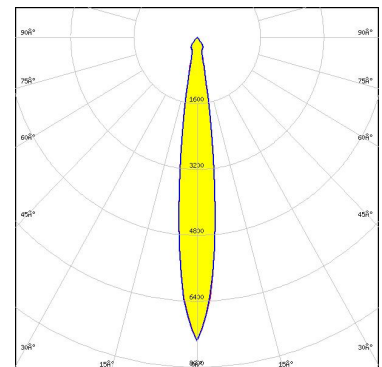

Light distribution files

OPTICAL RESULTS (SIMULATED):

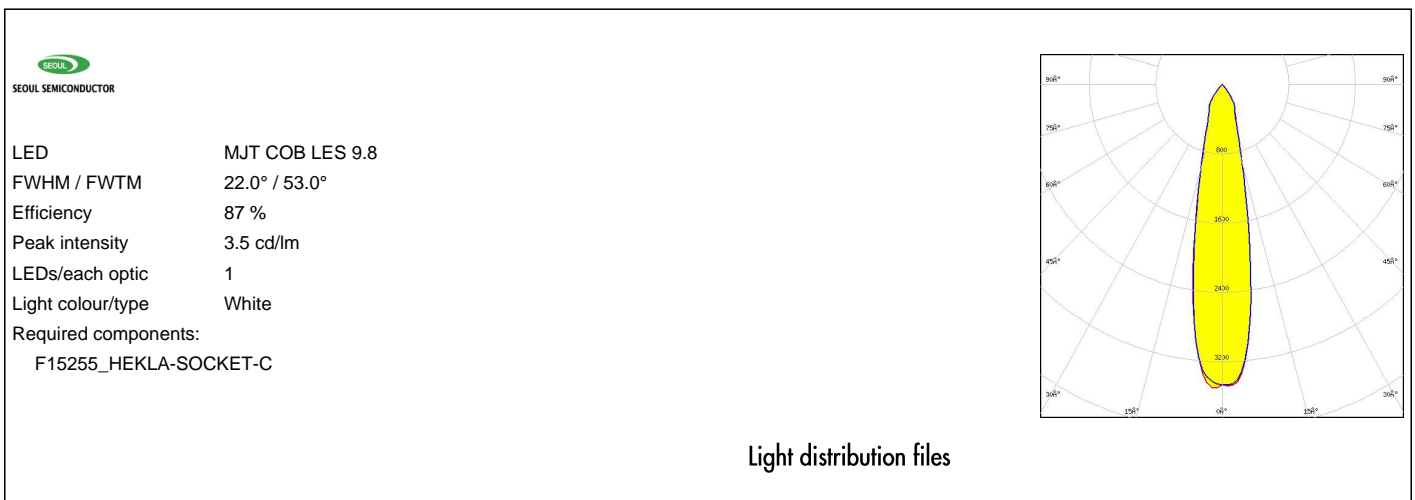
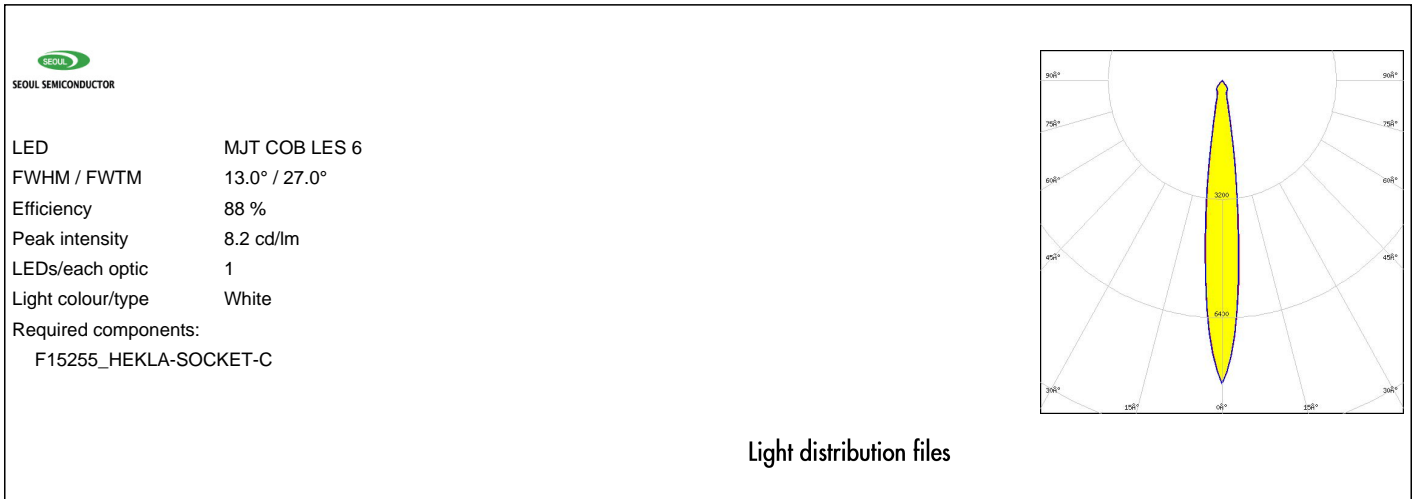

GENERAL INFORMATION:

NOTE: The typical beam angle will be changed by different color, chip size and chip position tolerance. The typical total beam angle is the full angle measured where the luminous intensity is half of the peak value.

Due to use of high power COB's with this product, special attention to proper thermal design is highly recommended. LEDiL has no liability for direct, indirect or consecutive damages arising from the LEDiL products being used outside of the recommended temperature range.

MATERIALS:

As part of our continuous research and improvement processes, and to ensure the best possible quality and availability of our products, LEDiL reserves the right to change material grades without notice.

PRODUCT DATA USER AGREEMENT AND DISCLAIMER:

The measured data in the provided downloadable LEDiL Product Datasheets and Mechanical 2D-Drawings is rounded and provided as reference for planning. LEDiL Oy's optical specifications have been verified by conducting performance testing of the products in accordance with the company's quality system. The reported data are averaged results of multiple measurements with typical variation. LEDiL Oy reserves the right to without prior notification make changes and improvements to its products.

LEDiL Oy assumes neither warranty, nor guarantee nor any other liability of any kind for the contents and correctness of the provided data. The provided data has been generated with highest diligence but the provided data may in reality not represent the complete possible variation range of all intrinsic parameters. Therefore, in certain cases a deviation from the provided data could occur.

LEDiL Oy reserves the right to undertake technical changes of its products without further notification which could lead to changes in the provided data. LEDiL Oy assumes no liability of any kind for the possible deviation from any provided data or any other damage resulting from the usage of the provided data.

The user agrees to this disclaimer and user agreement with the download or usage of the provided files.

LEDiL Oy

Joensuunkatu 13
FI-24240 SALO
Finland

LEDiL Inc.

228 West Page Street
Suite D
Sycamore IL 60178
USA

Ledil Optics Technology (Shenzhen) Co., Ltd.

405 , Block B
Casic Motor Building
Shenzhen 518057
P.R.CHINA

Local sales and technical support

[www.ledil.com/
where_to_buy](http://www.ledil.com/where_to_buy)

Shipping locations

Poznan, Poland
Hong Kong, China

Distribution Partners

[www.ledil.com/
where_to_buy](http://www.ledil.com/where_to_buy)