

MOLLY-M

~35° medium beam

SPECIFICATION:

Dimensions	Ø 69.8
Height	23.6 mm
ROHS compliant	yes ⓘ



MATERIALS:

Component	Type	Material	Colour	Finish	Length (mm)
MOLLY-M	Single lens	PMMA	clear		

ORDERING INFORMATION:

Component	Qty in box	MOQ	MPQ	Box weight (kg)
C15801_MOLLY-M » Box size: 476 x 273 x 292 mm	198	36	18	9.0

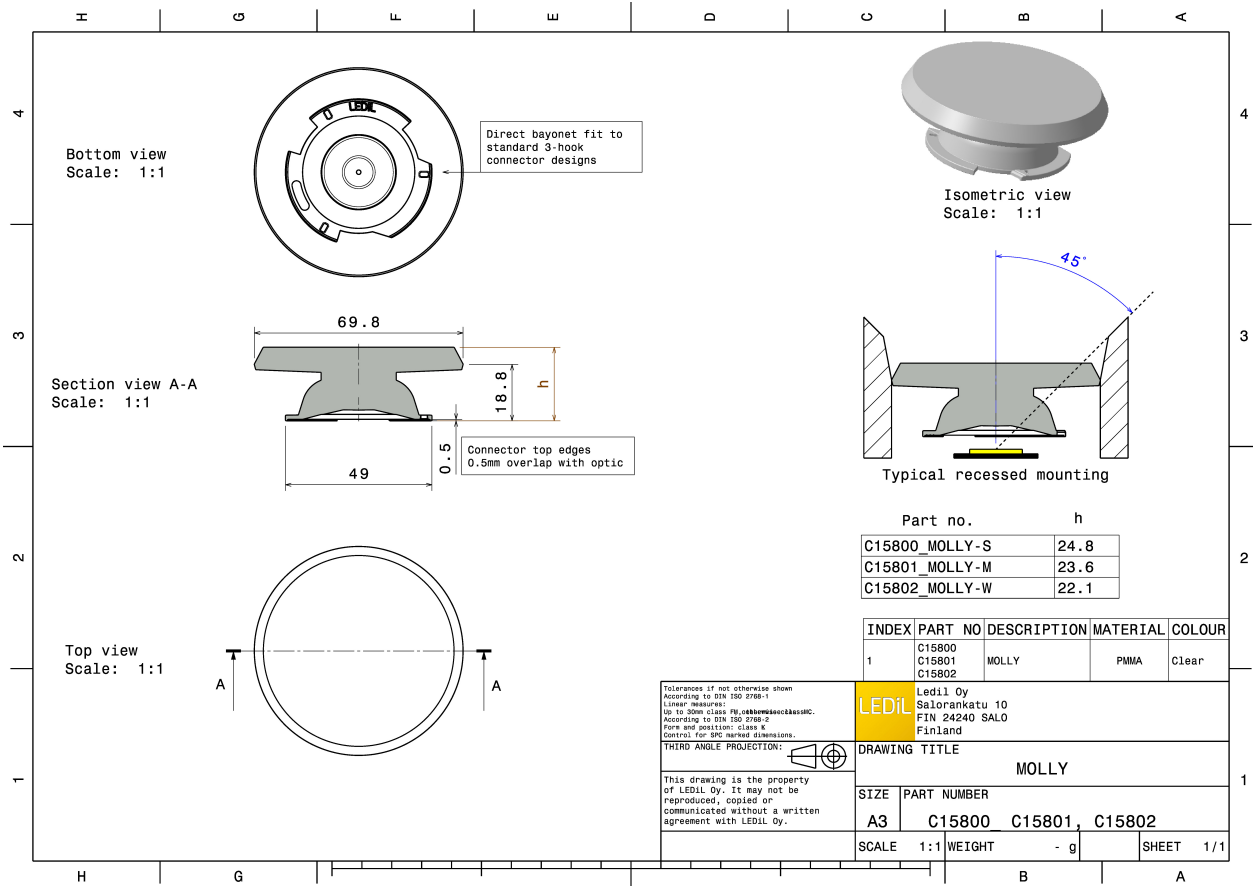

See also our general installation guide: www.ledil.com/installation_guide

OPTICAL RESULTS (MEASURED):

bridgelux

LED V11 HD Gen 8
 FWHM / FWTM 33.0° / 52.0°
 Efficiency 90 %
 Peak intensity 2.4 cd/lm
 LEDs/each optic 1
 Light colour/type White
 Required components:
 Bender Wirth: 633d 3Hook

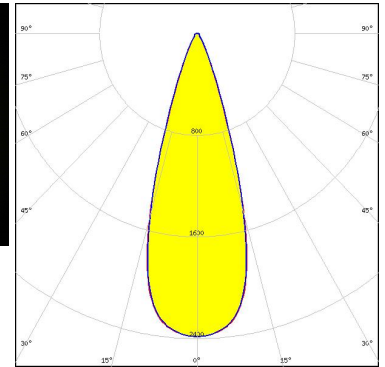

Light distribution files

bridgelux

LED Vero SE 13
 FWHM / FWTM 36.0° / 54.0°
 Efficiency 90 %
 Peak intensity 2.1 cd/lm
 LEDs/each optic 1
 Light colour/type White
 Required components:
 C16402_CLAMP-VEROSE-13-18

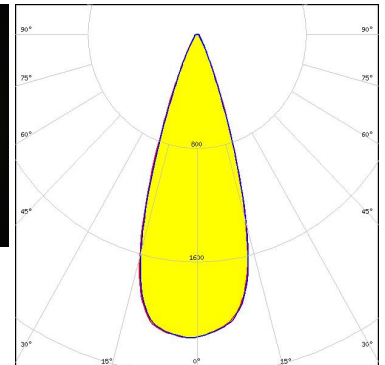
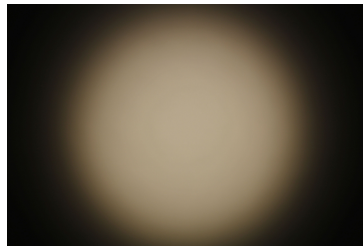

Light distribution files

bridgelux

LED Vero SE 18
 FWHM / FWTM 40.0° / 62.0°
 Efficiency 89 %
 Peak intensity 1.7 cd/lm
 LEDs/each optic 1
 Light colour/type White
 Required components:
 C16402_CLAMP-VEROSE-13-18

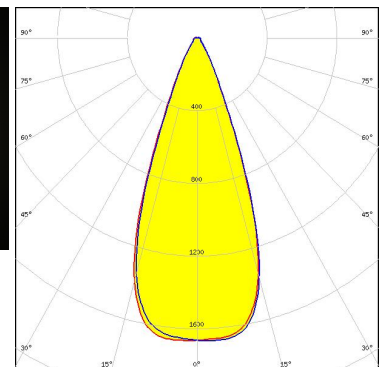
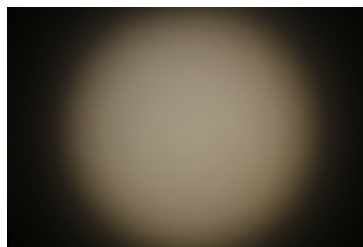

Light distribution files

OPTICAL RESULTS (MEASURED):



LED Vesta TW 15mm DP
FWHM / FWTM 38.0° / 58.0°
Efficiency 90 %
Peak intensity 1.9 cd/lm
LEDs/each optic 1
Light colour/type Tunable White
Required components:
 C13658_CLAMP-VERO13-18
 Bender Wirth: 482 Typ L2

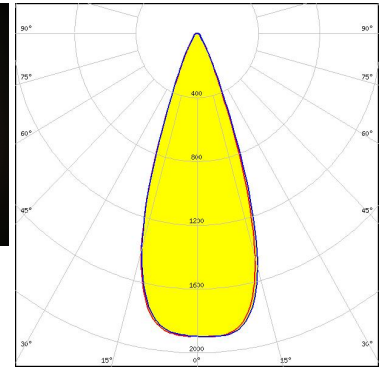
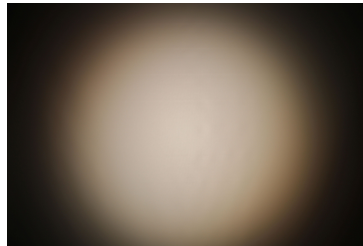

Light distribution files



LED Vesta TW 18mm (31W) DP
FWHM / FWTM 40.0° / 61.0°
Efficiency 88 %
Peak intensity 1.7 cd/lm
LEDs/each optic 1
Light colour/type Tunable White
Required components:
 C13584_CLAMP-VERO29
 Bender Wirth: 483 Typ L3

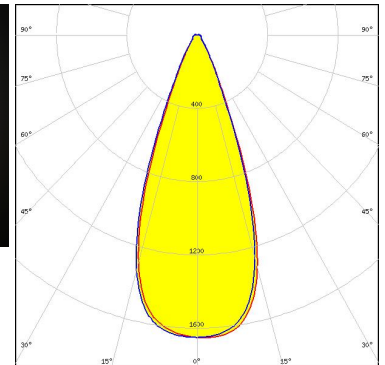
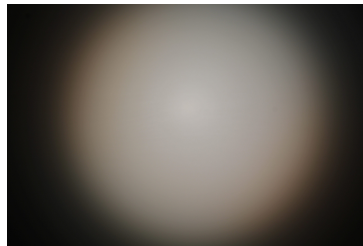

Light distribution files

CITIZEN

LED CLL03x/CLU03x
FWHM / FWTM 36.0° / 55.0°
Efficiency 89 %
Peak intensity 2.1 cd/lm
LEDs/each optic 1
Light colour/type White
Required components:
 Bender Wirth: 433 Typ L1

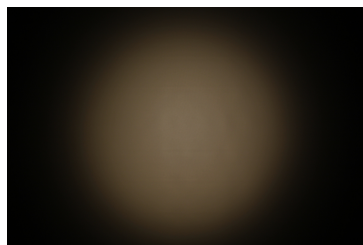

OPTICAL RESULTS (MEASURED):

CITIZEN

LED LCN-C02B (Tunable White)
 FWHM / FWTM 35.0° / 53.0°
 Efficiency 89 %
 Peak intensity 2.2 cd/lm
 LEDs/each optic 1
 Light colour/type White
 Required components:
 C13658_CLAMP-VERO13-18
 Bender Wirth: 481 Typ L2

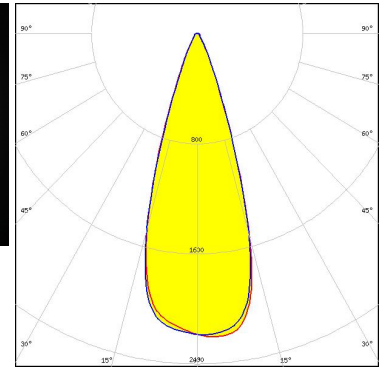
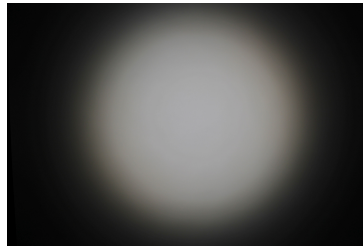

Light distribution files



LED CMA1840
 FWHM / FWTM 37.0° / 56.0°
 Efficiency 91 %
 Peak intensity 2 cd/lm
 LEDs/each optic 1
 Light colour/type White
 Required components:
 C14123_CLAMP-CXA15-18

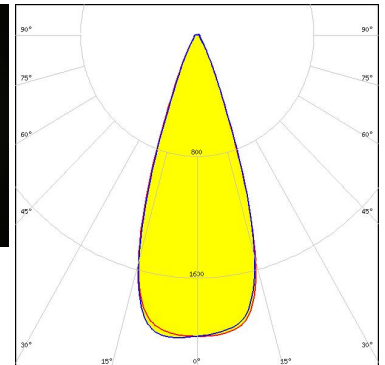
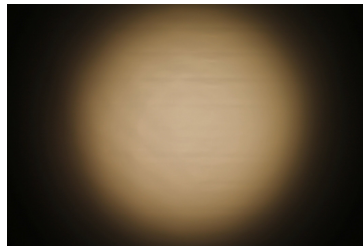

Light distribution files



LED CMA2550
 FWHM / FWTM 42.0° / 62.0°
 Efficiency 89 %
 Peak intensity 1.6 cd/lm
 LEDs/each optic 1
 Light colour/type White
 Required components:
 C14036_CLAMP_CXA25-30

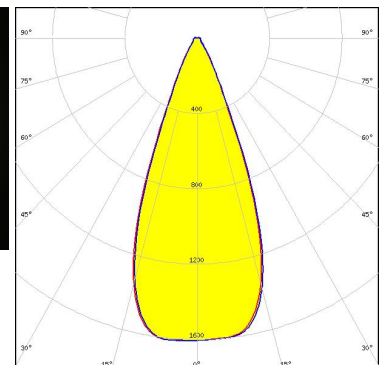
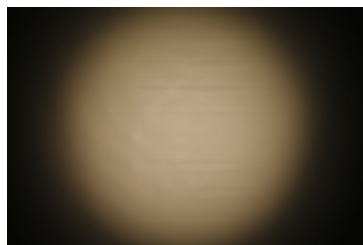

Light distribution files

OPTICAL RESULTS (MEASURED):



LED CMA3090
FWHM / FWTM 45.0° / 68.0°
Efficiency 88 %
Peak intensity 1.4 cd/lm
LEDs/each optic 1
Light colour/type White
Required components:
 C14036_CLAMP_CXA25-30

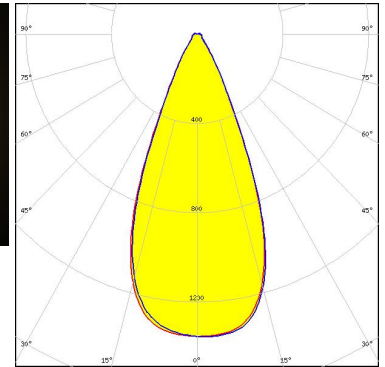
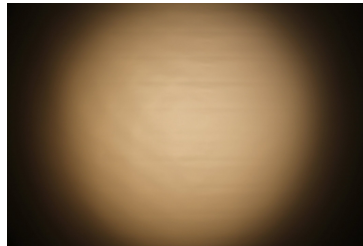

Light distribution files



LED CMT14xx
FWHM / FWTM 33.0° / 50.0°
Efficiency 90 %
Peak intensity 2.5 cd/lm
LEDs/each optic 1
Light colour/type White
Required components:
 C13658_CLAMP-VERO13-18
 Bender Wirth: 434 Typ L1

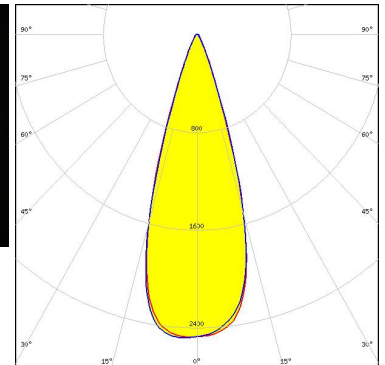

Light distribution files



LED CMT19xx
FWHM / FWTM 36.0° / 55.0°
Efficiency 90 %
Peak intensity 2.1 cd/lm
LEDs/each optic 1
Light colour/type White
Required components:
 C13658_CLAMP-VERO13-18
 Bender Wirth: 477 Typ L1

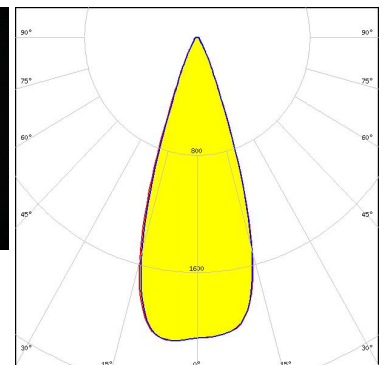
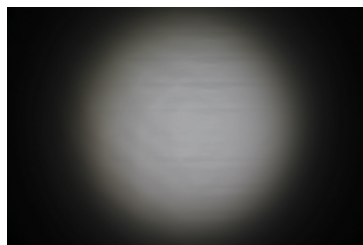

Light distribution files

OPTICAL RESULTS (MEASURED):



LED CMT28xx
FWHM / FWTM 42.0° / 65.0°
Efficiency 87 %
Peak intensity 1.5 cd/lm
LEDs/each optic 1
Light colour/type White
Required components:
 C13584_CLAMP-VERO29
 Bender Wirth: 471 Typ L3

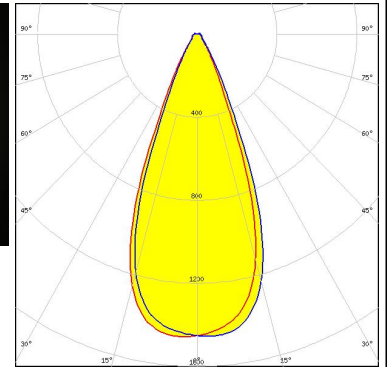
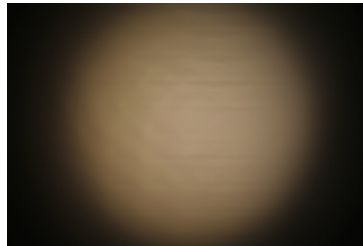

Light distribution files



LED CXA/B 15xx
FWHM / FWTM 34.0° / 51.0°
Efficiency 90 %
Peak intensity 2.4 cd/lm
LEDs/each optic 1
Light colour/type White
Required components:
 C14123_CLAMP-CXA15-18

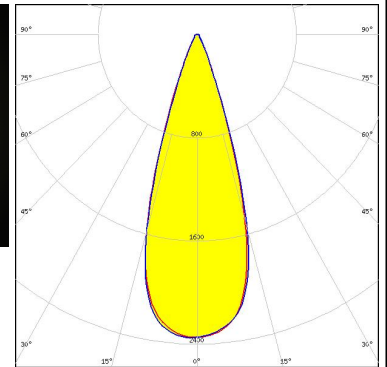
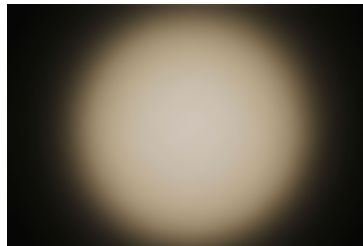

Light distribution files



LED PrevaLED Core G7 L15 H1
FWHM / FWTM 35.0° / 55.0°
Efficiency 90 %
Peak intensity 2.1 cd/lm
LEDs/each optic 1
Light colour/type White
Required components:
 C16685_CLAMP-PRV-A

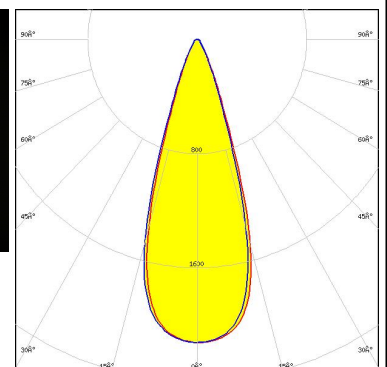
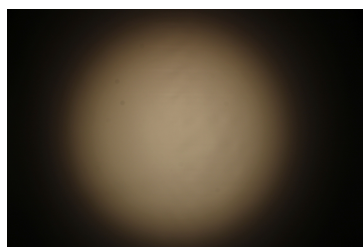

Light distribution files

OPTICAL RESULTS (MEASURED):



LED LUXEON CoB 1204HD
FWHM / FWTM 30.0° / 46.0°
Efficiency 89 %
Peak intensity 2.9 cd/lm
LEDs/each optic 1
Light colour/type White
Required components:
 TE Connectivity: 2213382-2 + OPTIC CLIP Z50 TYPE1 2213194-1

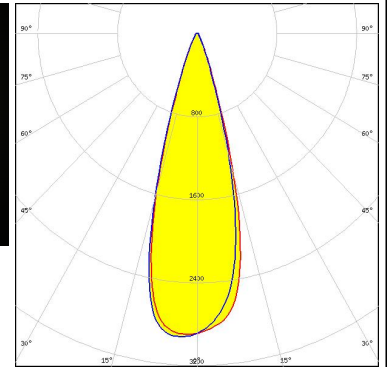
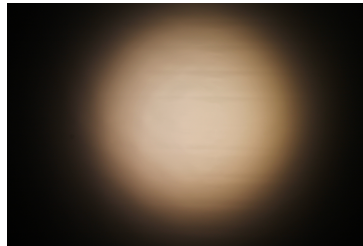

Light distribution files



LED CDM-14 (Dim-To-Warm)
FWHM / FWTM 36.0° / 54.0°
Efficiency 89 %
Peak intensity 2 cd/lm
LEDs/each optic 1
Light colour/type White
Required components:
 C13658_CLAMP-VERO13-18
 Bender Wirth: 491 Typ L2

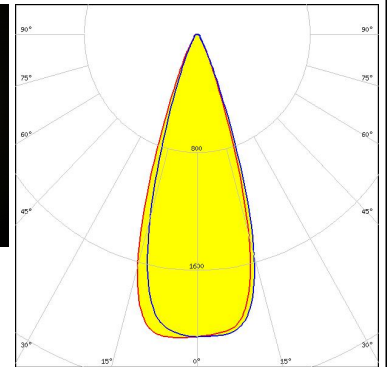
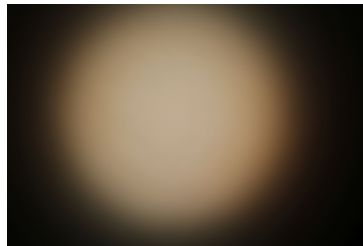

Light distribution files



LED CDM-18 (Dim-To-Warm)
FWHM / FWTM 38.0° / 57.0°
Efficiency 89 %
Peak intensity 1.9 cd/lm
LEDs/each optic 1
Light colour/type White
Required components:
 C13658_CLAMP-VERO13-18
 Bender Wirth: 491 Typ L2

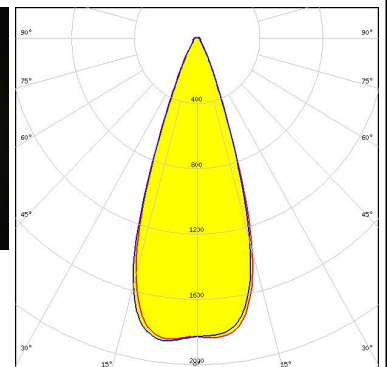
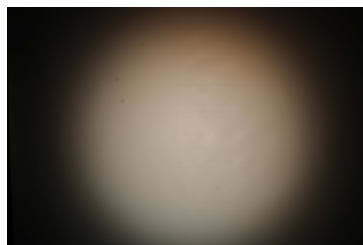

Light distribution files

OPTICAL RESULTS (MEASURED):



LED CDM-9 (Dim-To-Warm)
FWHM / FWTM 33.0° / 49.0°
Efficiency 89 %
Peak intensity 2.4 cd/lm
LEDs/each optic 1
Light colour/type White
Required components:
 C13658_CLAMP-VERO13-18
 Bender Wirth: 490 Typ L1

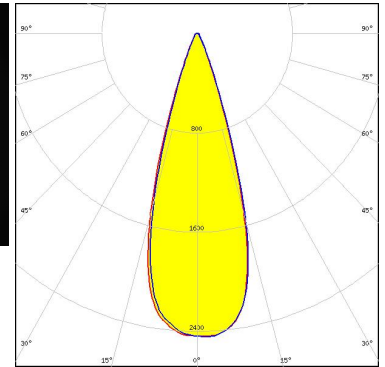
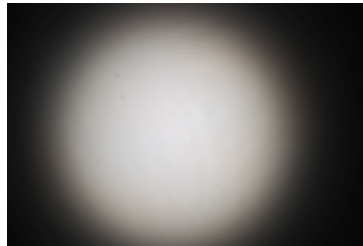

Light distribution files



LED CTM-14 (Tunable White)
FWHM / FWTM 34.0° / 52.0°
Efficiency 88 %
Peak intensity 2.2 cd/lm
LEDs/each optic 1
Light colour/type White
Required components:
 C13584_CLAMP-VERO29
 Bender Wirth: 442 Typ L3

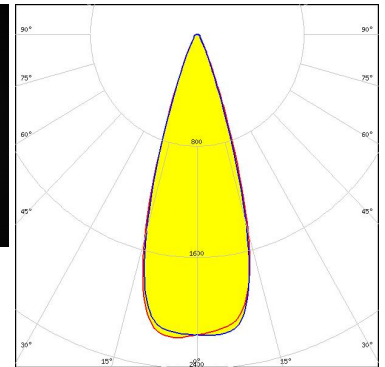
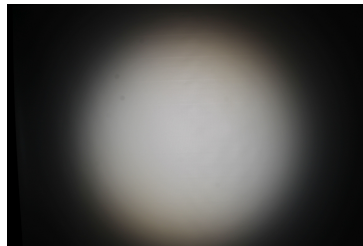

Light distribution files



LED CTM-14 RGBW
FWHM / FWTM 35.0° / 55.0°
Efficiency 88 %
Peak intensity 2 cd/lm
LEDs/each optic 1
Light colour/type RGBW
Required components:
 C13584_CLAMP-VERO29
 Bender Wirth: 500 Typ L3-1

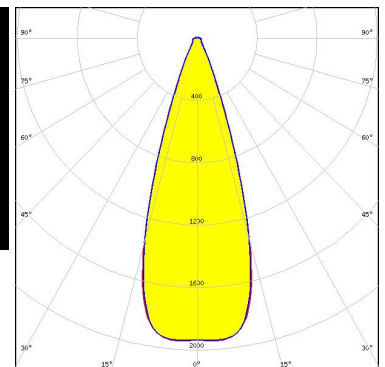
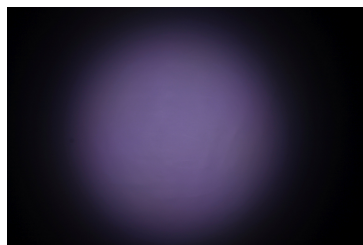

Light distribution files

OPTICAL RESULTS (MEASURED):



LED CTM-22 (Tunable White)
FWHM / FWTM 42.0° / 64.0°
Efficiency 87 %
Peak intensity 1.5 cd/lm
LEDs/each optic 1
Light colour/type White
Required components:
 C13584_CLAMP-VERO29
 Bender Wirth: 494 Typ L3

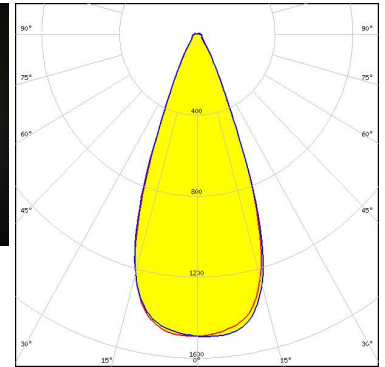
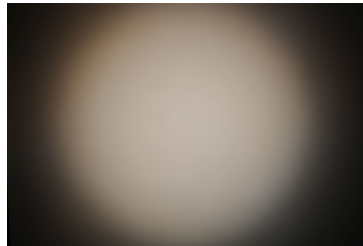

Light distribution files



LED NVCWJ024Z-V1MT: COB J-Type Tunable White
FWHM / FWTM 33.0° / 51.0°
Efficiency 89 %
Peak intensity 2.4 cd/lm
LEDs/each optic 1
Light colour/type White
Required components:
 C13658_CLAMP-VERO13-18
 Bender Wirth: 498 Typ L2

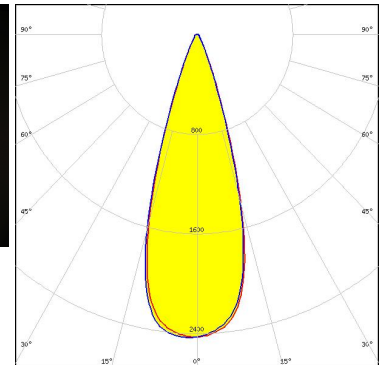
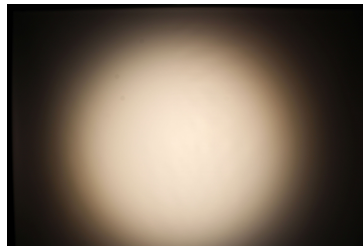

Light distribution files



LED Fortimo SLM L13 CoB
FWHM / FWTM 35.0° / 53.0°
Efficiency 89 %
Peak intensity 2.2 cd/lm
LEDs/each optic 1
Light colour/type White
Required components:
 TE Connectivity: 2213130-2 + OPTIC CLIP Z50 TYPE1 2213194-1

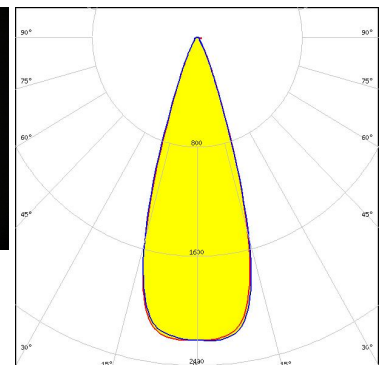
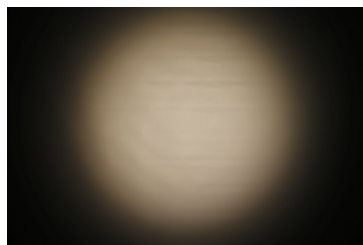

Light distribution files

OPTICAL RESULTS (MEASURED):

PHILIPS

LED Fortimo SLM L15 + SLM holder
 FWHM / FWTM 34.0° / 53.0°
 Efficiency 89 %
 Peak intensity 2.3 cd/lm
 LEDs/each optic 1
 Light colour/type White
 Required components:
 TE Connectivity: OPTIC CLIP Z50 TYPE1 2213194-1

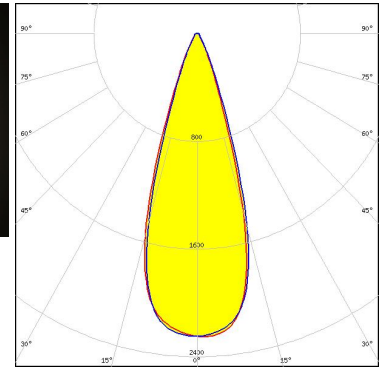
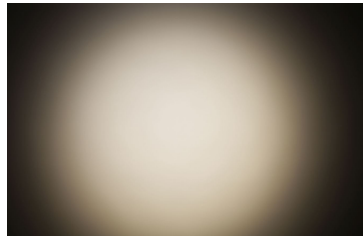

Light distribution files

PHILIPS

LED Fortimo SLM L15 CoB
 FWHM / FWTM 36.0° / 54.0°
 Efficiency 88 %
 Peak intensity 2.1 cd/lm
 LEDs/each optic 1
 Light colour/type White
 Required components:
 TE Connectivity: 2213130-2 + OPTIC CLIP Z50 TYPE1 2213194-1

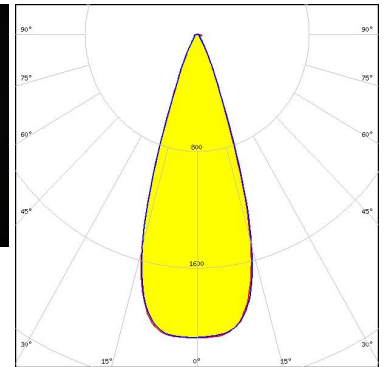
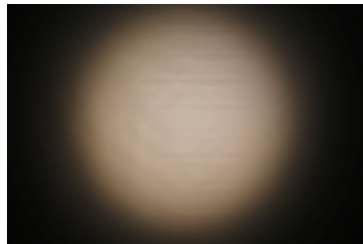

Light distribution files

SAMSUNG

LED LC035T (Tunable white)
 FWHM / FWTM 43.0° / 67.0°
 Efficiency 88 %
 Peak intensity 1.4 cd/lm
 LEDs/each optic 1
 Light colour/type White
 Required components:
 C13584_CLAMP-VERO29
 Bender Wirth: 502 Typ L3

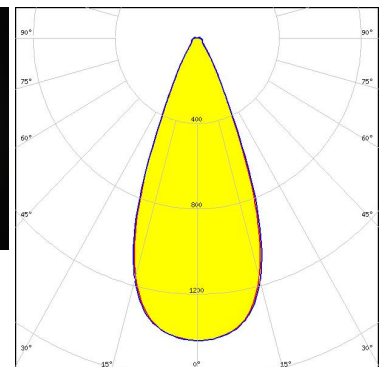
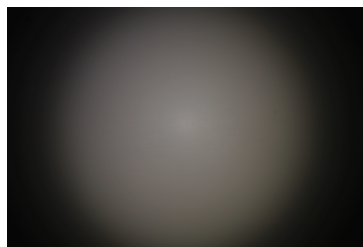

Light distribution files

OPTICAL RESULTS (MEASURED):

XICATO

LED XTM - 19mm LES
FWHM / FWTM 39.0° / 60.0°
Efficiency 90 %
Peak intensity 1.8 cd/lm
LEDs/each optic 1
Light colour/type White
Required components:
C16491_XTM-ADAPTER-50-A

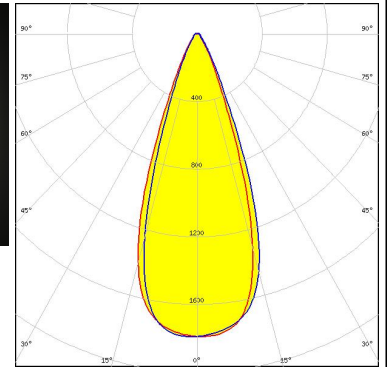
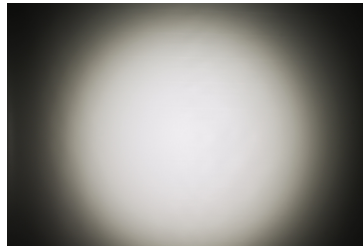

Light distribution files

OPTICAL RESULTS (SIMULATED):



LED V9 HD Gen7
 FWHM / FWTM 32.0° / 44.0°
 Efficiency 90 %
 Peak intensity 3.3 cd/lm
 LEDs/each optic 1
 Light colour/type White

Required components:

C13658_CLAMP-VERO13-18

Bender Wirth: 496 Typ L1

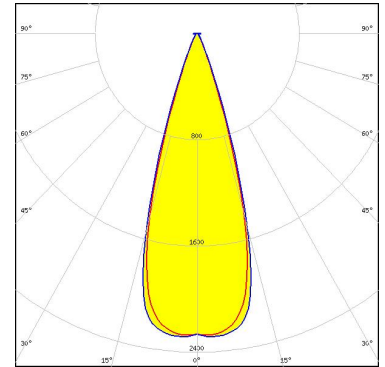

Light distribution files



LED VERO13
 FWHM / FWTM 32.0° / 46.0°
 Efficiency 91 %
 Peak intensity 3.1 cd/lm
 LEDs/each optic 1
 Light colour/type White

Required components:

C13658_CLAMP-VERO13-18

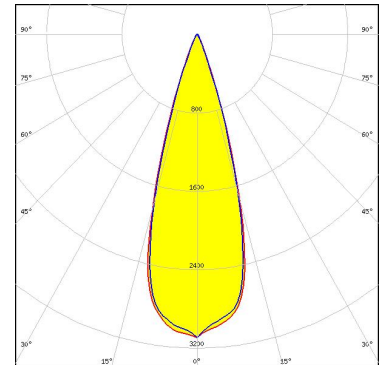

Light distribution files

CITIZEN

LED CLL02x/CLU02x (LES10)
 FWHM / FWTM 30.0° / 42.0°
 Efficiency 89 %
 Peak intensity 3.6 cd/lm
 LEDs/each optic 1
 Light colour/type White

Required components:

Bender Wirth: 434 Typ L1

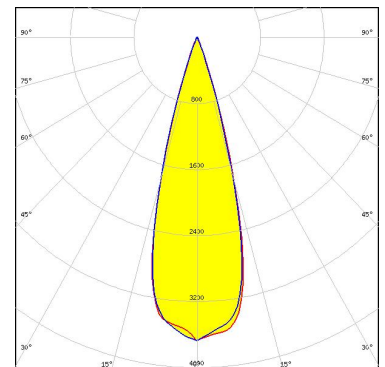

Light distribution files

OPTICAL RESULTS (SIMULATED):



LED CXA/B 1816 & CXA/B 1820 & CXA 1850
 FWHM / FWTM 33.0° / 47.0°
 Efficiency 90 %
 Peak intensity 3.1 cd/lm
 LEDs/each optic 1
 Light colour/type White
 Required components:
 C14123_CLAMP-CXA15-18

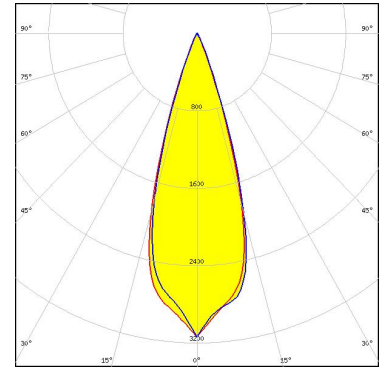

Light distribution files



LED CXA/B 25xx
 FWHM / FWTM 36.0° / 50.0°
 Efficiency 88 %
 Peak intensity 2.2 cd/lm
 LEDs/each optic 1
 Light colour/type White
 Required components:
 C14036_CLAMP_CXA25-30

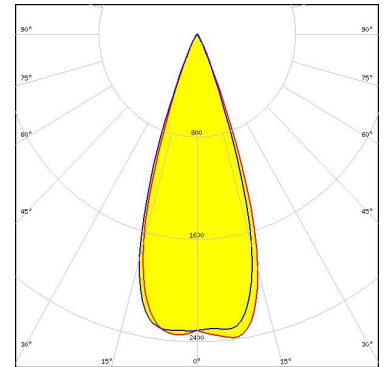

Light distribution files



LED CTM-18 (Tunable White)
 FWHM / FWTM 34.0° / 47.0°
 Efficiency 80 %
 Peak intensity 2.3 cd/lm
 LEDs/each optic 1
 Light colour/type White
 Required components:
 C13658_CLAMP-VERO13-18

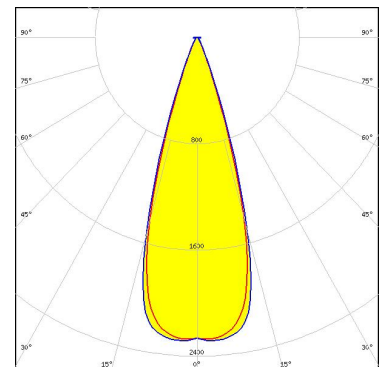

Light distribution files

GENERAL INFORMATION:

NOTE: The typical beam angle will be changed by different color, chip size and chip position tolerance. The typical total beam angle is the full angle measured where the luminous intensity is half of the peak value.

Due to use of high power COB's with this product, special attention to proper thermal design is highly recommended. LEDiL has no liability for direct, indirect or consecutive damages arising from the LEDiL products being used outside of the recommended temperature range.

MATERIALS:

As part of our continuous research and improvement processes, and to ensure the best possible quality and availability of our products, LEDiL reserves the right to change material grades without notice.

PRODUCT DATA USER AGREEMENT AND DISCLAIMER:

The measured data in the provided downloadable LEDiL Product Datasheets and Mechanical 2D-Drawings is rounded and provided as reference for planning. LEDiL Oy's optical specifications have been verified by conducting performance testing of the products in accordance with the company's quality system. The reported data are averaged results of multiple measurements with typical variation. LEDiL Oy reserves the right to without prior notification make changes and improvements to its products.

LEDiL Oy assumes neither warranty, nor guarantee nor any other liability of any kind for the contents and correctness of the provided data. The provided data has been generated with highest diligence but the provided data may in reality not represent the complete possible variation range of all intrinsic parameters. Therefore, in certain cases a deviation from the provided data could occur.

LEDiL Oy reserves the right to undertake technical changes of its products without further notification which could lead to changes in the provided data. LEDiL Oy assumes no liability of any kind for the possible deviation from any provided data or any other damage resulting from the usage of the provided data.

The user agrees to this disclaimer and user agreement with the download or usage of the provided files.

LEDiL Oy

Joensuunkatu 7
FI-24240 SALO
Finland

LEDiL Inc.

228 West Page Street
Suite D
Sycamore IL 60178
USA

Ledil Optics Technology (Shenzhen) Co., Ltd.

405 , Block B
Casic Motor Building
Shenzhen 518057
P.R.CHINA

Local sales and technical support

[www.ledil.com/
where_to_buy](http://www.ledil.com/where_to_buy)

Shipping locations

Poznan, Poland
Hong Kong, China

Distribution Partners

[www.ledil.com/
where_to_buy](http://www.ledil.com/where_to_buy)