

OLGA-M

~30° wide beam. Assembly with holder and installation tape.

SPECIFICATION:

Dimensions	Ø 32.0
Height	19.1 mm
Fastening	tape, pin
ROHS compliant	yes ⓘ

MATERIALS:

Component	Type	Material	Colour	Finish	Length (mm)
OLGA-M	Single lens	PMMA	clear		
OLGA-HLD	Holder	PC	black		
SPUTNIK-TAPE3	Tape	Acrylic foam tape	black		

ORDERING INFORMATION:

Component	Qty in box	MOQ	MPQ	Box weight (kg)
CA16128_OLGA-M » Box size: 476 x 273 x 292 mm	792	132	66	9.8



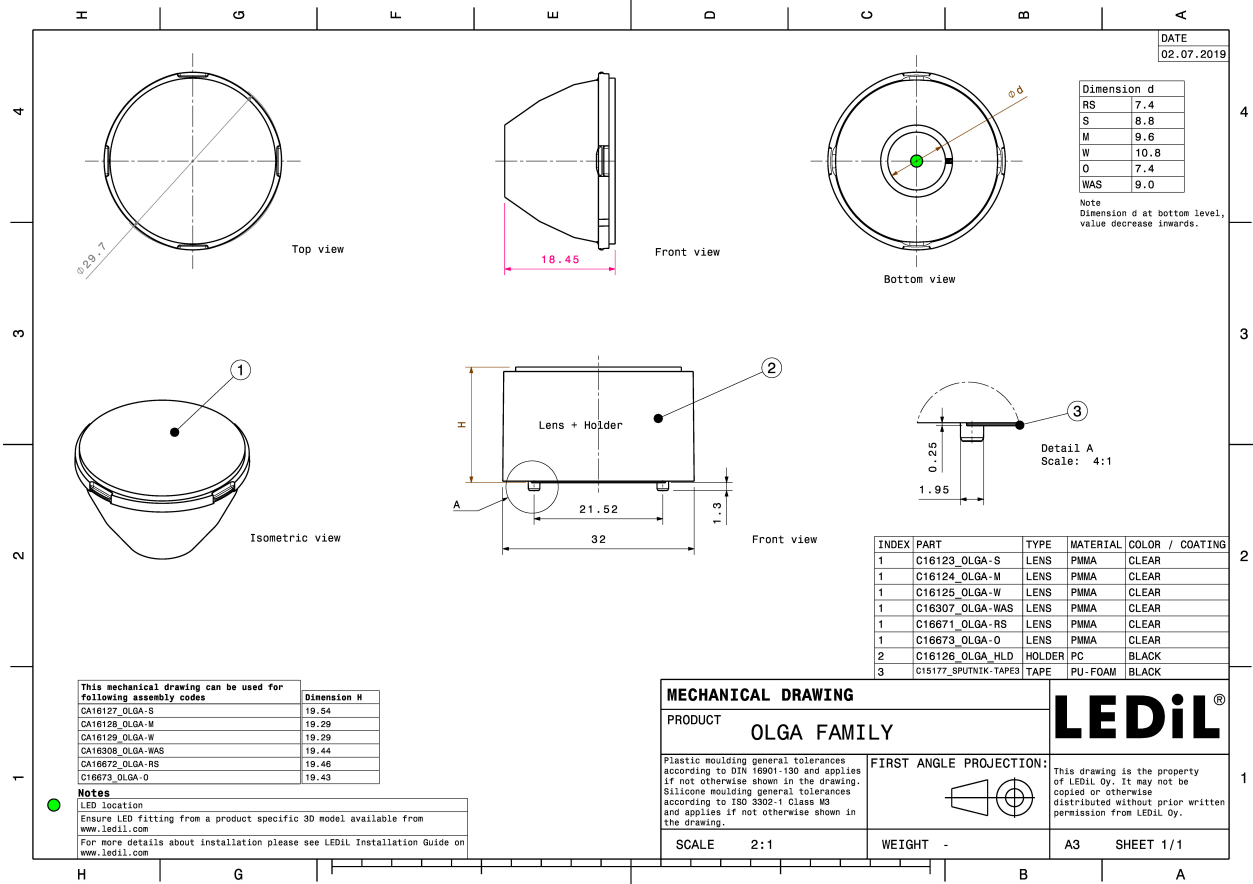

See also our general installation guide: www.ledil.com/installation_guide

OPTICAL RESULTS (MEASURED):



LED XD16
 FWHM / FWTM 26.0° / 48.0°
 Efficiency 80 %
 Peak intensity 3.2 cd/lm
 LEDs/each optic 1
 Light colour/type White
 Required components:

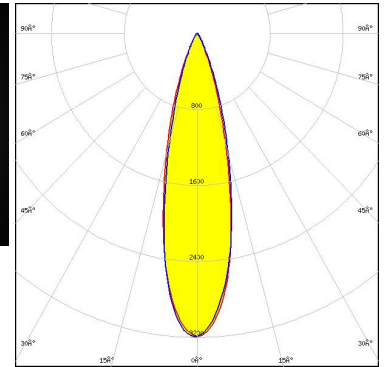
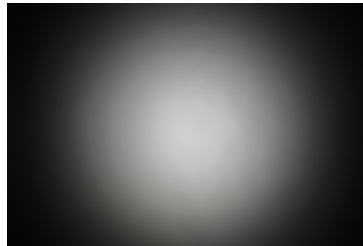

Light distribution files



LED XHP35 HD
 FWHM / FWTM 32.0° / 58.0°
 Efficiency 80 %
 Peak intensity 2.1 cd/lm
 LEDs/each optic 1
 Light colour/type White
 Required components:

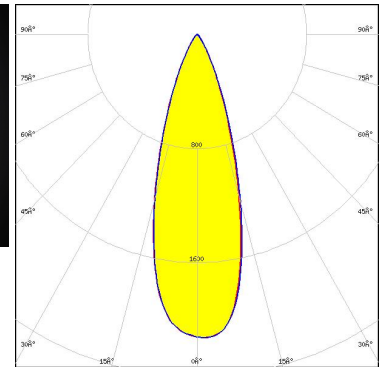
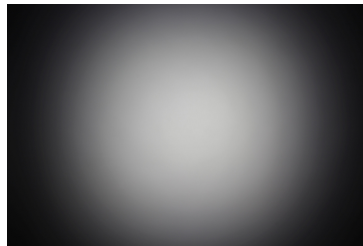

Light distribution files



LED XHP35 HI
 FWHM / FWTM 28.0° / 51.0°
 Efficiency 84 %
 Peak intensity 2.8 cd/lm
 LEDs/each optic 1
 Light colour/type White
 Required components:

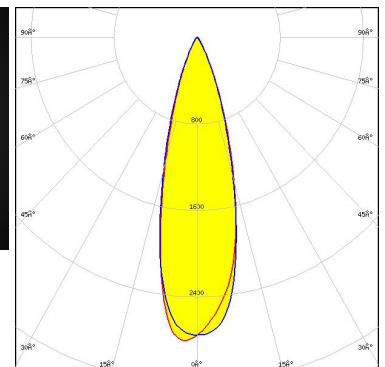
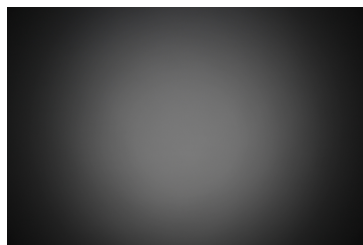

Light distribution files

OPTICAL RESULTS (MEASURED):



LED XHP50
 FWHM / FWTM 32.0° / 60.0°
 Efficiency 81 %
 Peak intensity 2.1 cd/lm
 LEDs/each optic 1
 Light colour/type White
 Required components:

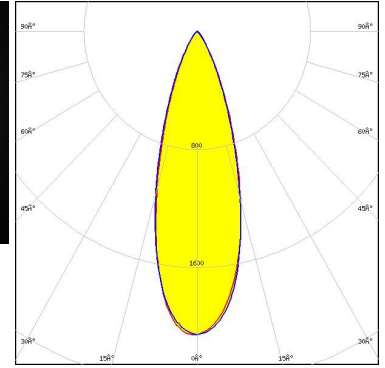

Light distribution files



LED XHP50.2
 FWHM / FWTM 31.0° / 58.0°
 Efficiency 81 %
 Peak intensity 2.3 cd/lm
 LEDs/each optic 1
 Light colour/type White
 Required components:

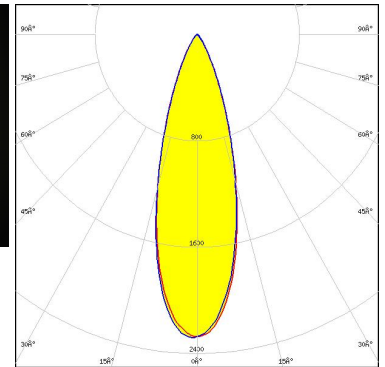
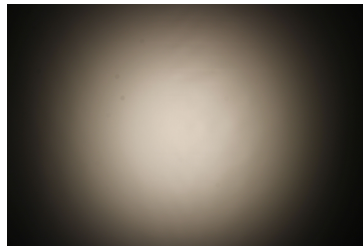

Light distribution files



LED XHP70
 FWHM / FWTM 33.0° / 63.0°
 Efficiency 82 %
 Peak intensity 2 cd/lm
 LEDs/each optic 1
 Light colour/type White
 Required components:

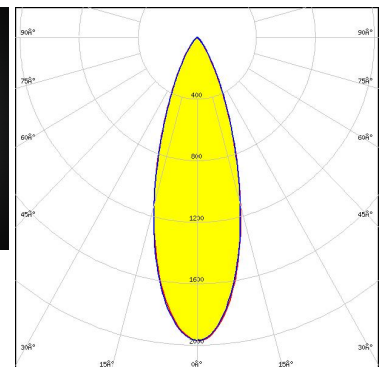
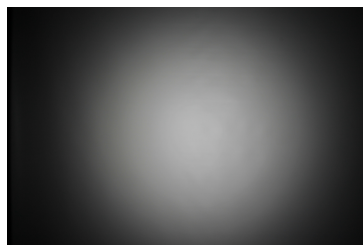

Light distribution files

OPTICAL RESULTS (MEASURED):



LED XHP70.2
 FWHM / FWTM 34.0° / 64.0°
 Efficiency 81 %
 Peak intensity 1.9 cd/lm
 LEDs/each optic 1
 Light colour/type White
 Required components:

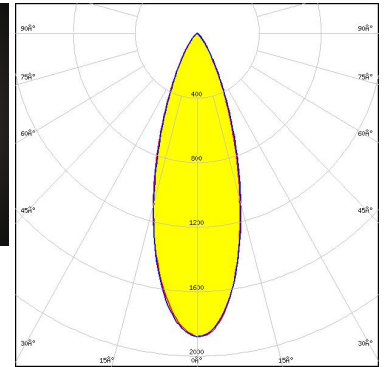
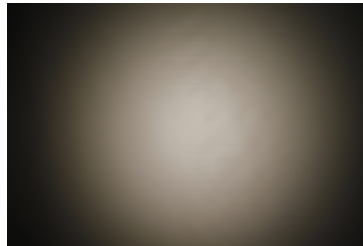

Light distribution files



LED XM-L
 FWHM / FWTM 31.0° / 55.0°
 Efficiency 83 %
 Peak intensity 2.4 cd/lm
 LEDs/each optic 1
 Light colour/type White
 Required components:

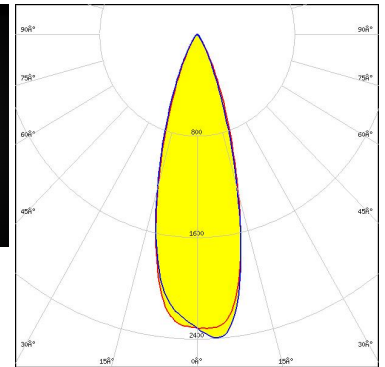
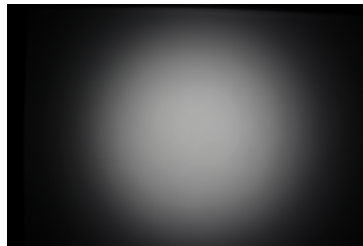

Light distribution files



LED XM-L3
 FWHM / FWTM 33.0° / 57.0°
 Efficiency 81 %
 Peak intensity 2.2 cd/lm
 LEDs/each optic 1
 Light colour/type White
 Required components:

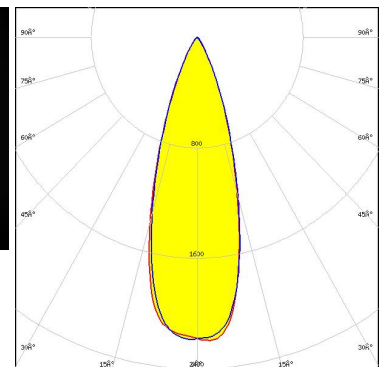
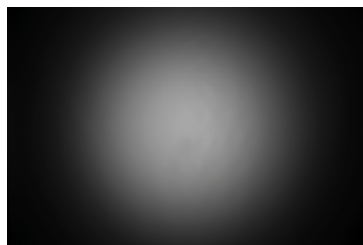

Light distribution files

OPTICAL RESULTS (MEASURED):



LED XP-G2
 FWHM / FWTM 30.0° / 53.0°
 Efficiency 83 %
 Peak intensity 2.7 cd/lm
 LEDs/each optic 1
 Light colour/type White
 Required components:

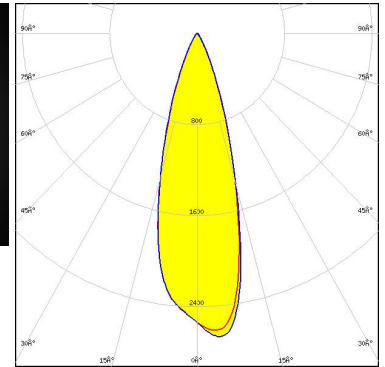
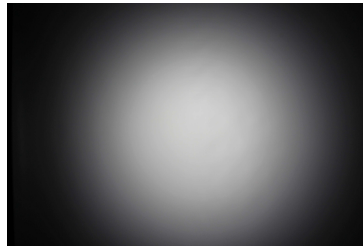

Light distribution files



LED XP-G3
 FWHM / FWTM 31.0° / 54.0°
 Efficiency 82 %
 Peak intensity 2.5 cd/lm
 LEDs/each optic 1
 Light colour/type White
 Required components:

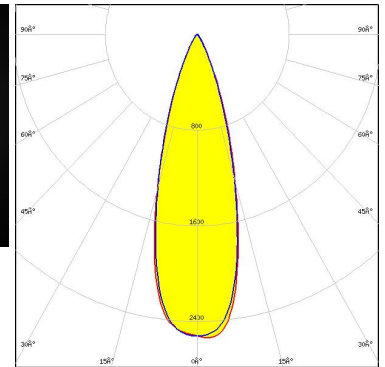
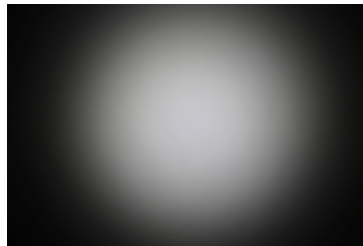

Light distribution files



LED XP-L HI
 FWHM / FWTM 28.0° / 50.0°
 Efficiency 85 %
 Peak intensity 3 cd/lm
 LEDs/each optic 1
 Light colour/type White
 Required components:

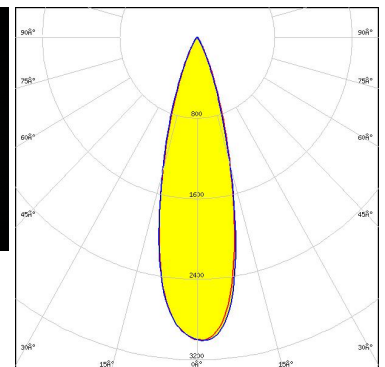
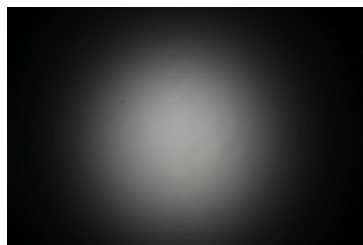

Light distribution files

OPTICAL RESULTS (MEASURED):



LED XP-L2
 FWHM / FWTM 30.0° / 54.0°
 Efficiency 81 %
 Peak intensity 2.5 cd/lm
 LEDs/each optic 1
 Light colour/type White
 Required components:

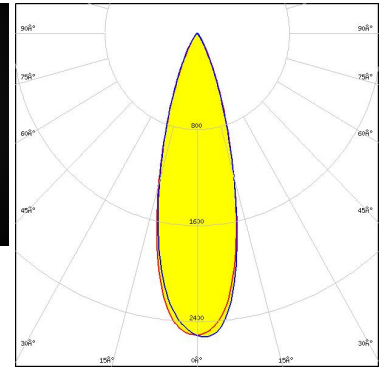
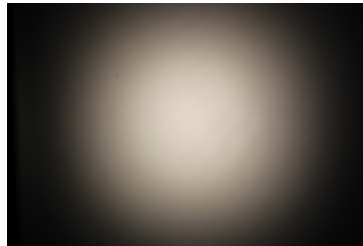

Light distribution files



LED XQ-E HD
 FWHM / FWTM 28.0° / 51.0°
 Efficiency 76 %
 Peak intensity 2.8 cd/lm
 LEDs/each optic 1
 Light colour/type White
 Required components:

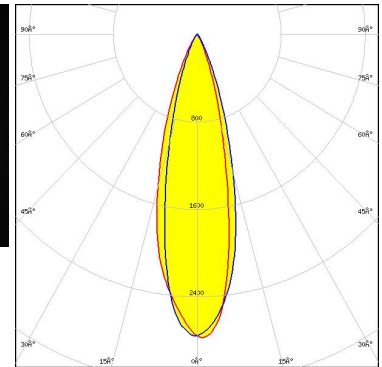
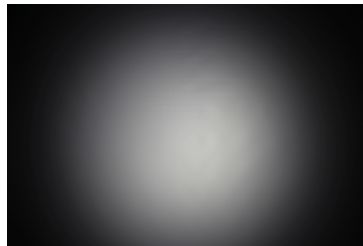

Light distribution files



LED XQ-E HI
 FWHM / FWTM 27.0° / 49.0°
 Efficiency 83 %
 Peak intensity 3.1 cd/lm
 LEDs/each optic 1
 Light colour/type White
 Required components:

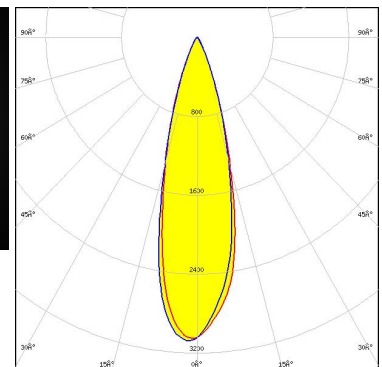
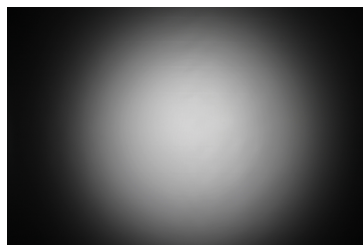

Light distribution files

OPTICAL RESULTS (MEASURED):



LED XT-E
 FWHM / FWTM 29.0° / 53.0°
 Efficiency 79 %
 Peak intensity 2.6 cd/lm
 LEDs/each optic 1
 Light colour/type White
 Required components:

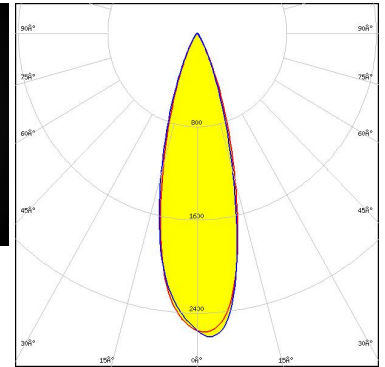
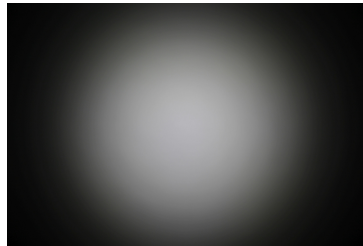

Light distribution files



LED LUXEON 5050 Round LES
 FWHM / FWTM 27.0° / 52.0°
 Efficiency 86 %
 Peak intensity 3 cd/lm
 LEDs/each optic 1
 Light colour/type White
 Required components:

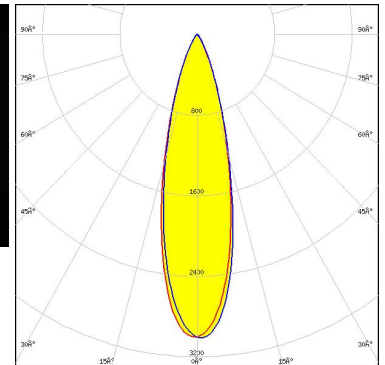
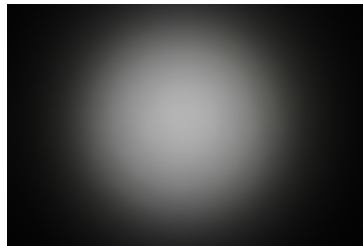

Light distribution files



LED LUXEON C
 FWHM / FWTM 29.0° / 52.0°
 Efficiency 76 %
 Peak intensity 2.6 cd/lm
 LEDs/each optic 1
 Light colour/type White
 Required components:

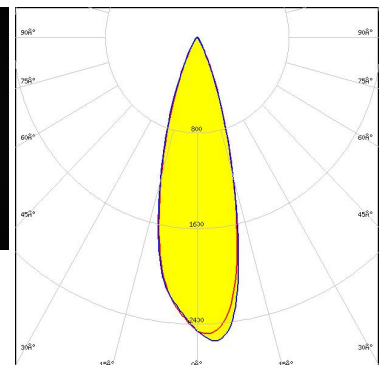
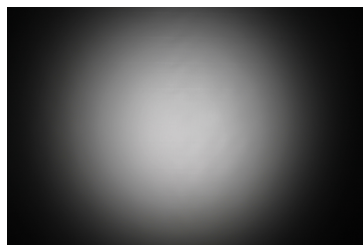

Light distribution files

OPTICAL RESULTS (MEASURED):



LED LUXEON CZ
FWHM / FWTM 26.0° / 47.0°
Efficiency 85 %
Peak intensity 3.5 cd/lm
LEDs/each optic 1
Light colour/type White
Required components:

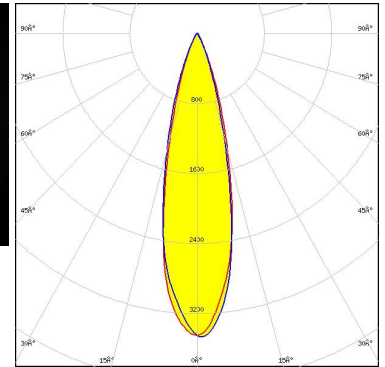
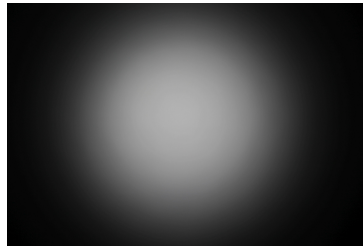

Light distribution files



LED LUXEON M/MX
FWHM / FWTM 31.0° / 59.0°
Efficiency 84 %
Peak intensity 2.3 cd/lm
LEDs/each optic 1
Light colour/type White
Required components:

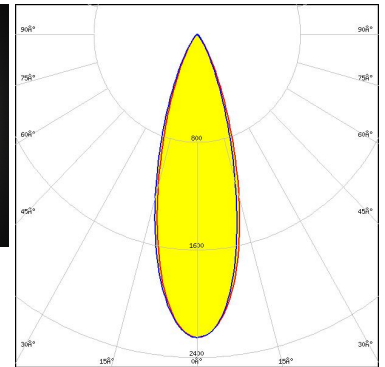
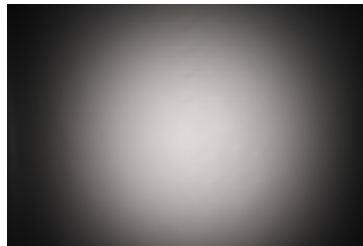

Light distribution files



LED LUXEON MZ
FWHM / FWTM 26.0° / 50.0°
Efficiency 85 %
Peak intensity 3.1 cd/lm
LEDs/each optic 1
Light colour/type White
Required components:

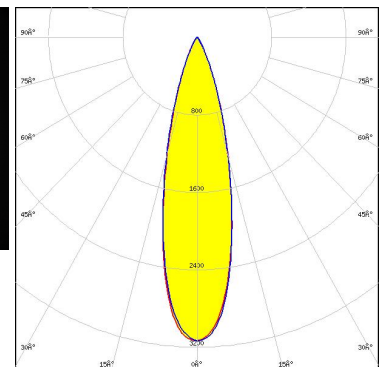
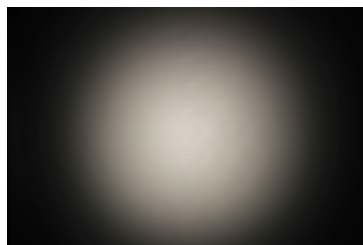

Light distribution files

OPTICAL RESULTS (MEASURED):



LED LUXEON Rebel ES
 FWHM / FWTM 28.0° / 51.0°
 Efficiency 83 %
 Peak intensity 3 cd/lm
 LEDs/each optic 1
 Light colour/type White
 Required components:

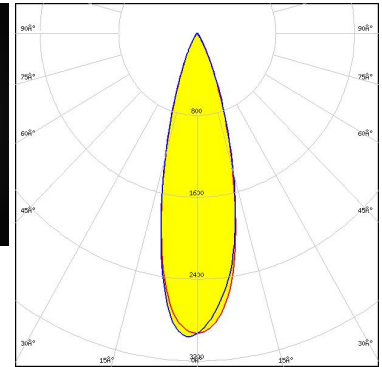
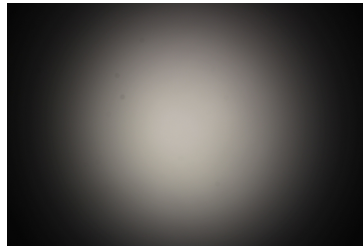

Light distribution files



LED LUXEON TX
 FWHM / FWTM 29.0° / 51.0°
 Efficiency 83 %
 Peak intensity 2.9 cd/lm
 LEDs/each optic 1
 Light colour/type White
 Required components:

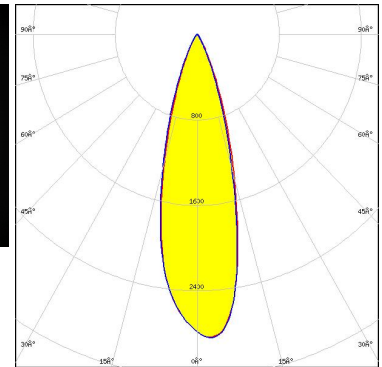
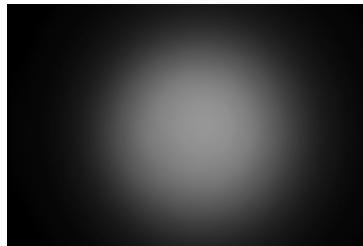

Light distribution files



LED LUXEON V
 FWHM / FWTM 29.0° / 54.0°
 Efficiency 82 %
 Peak intensity 2.6 cd/lm
 LEDs/each optic 1
 Light colour/type White
 Required components:

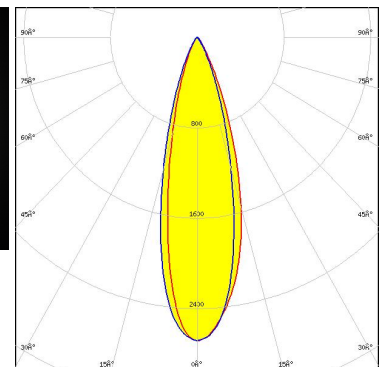
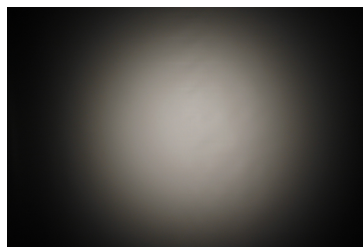

Light distribution files

OPTICAL RESULTS (MEASURED):



LED LUXEON V
 FWHM / FWTM 28.0° / 53.0°
 Efficiency 82 %
 Peak intensity 2.7 cd/lm
 LEDs/each optic 1
 Light colour/type White
 Required components:

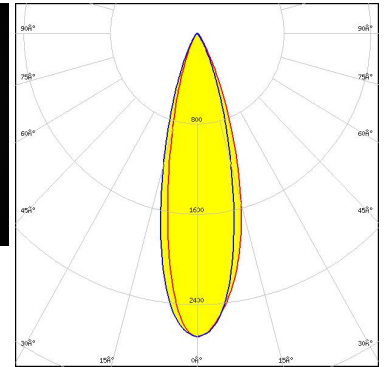
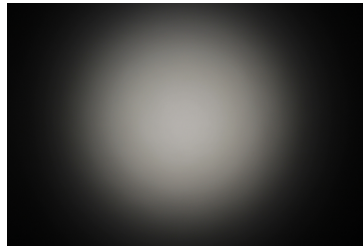

Light distribution files



LED LUXEON V2
 FWHM / FWTM 29.0° / 51.0°
 Efficiency 83 %
 Peak intensity 2.9 cd/lm
 LEDs/each optic 1
 Light colour/type White
 Required components:

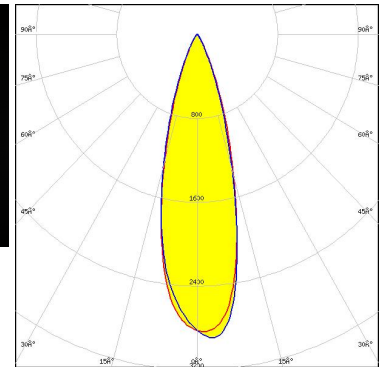
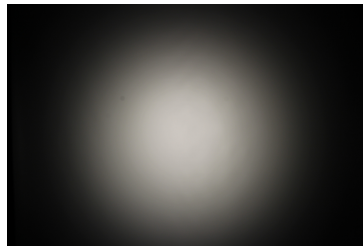

Light distribution files



LED LUXEON Z
 FWHM / FWTM 25.0° / 46.0°
 Efficiency 85 %
 Peak intensity 3.7 cd/lm
 LEDs/each optic 1
 Light colour/type White
 Required components:

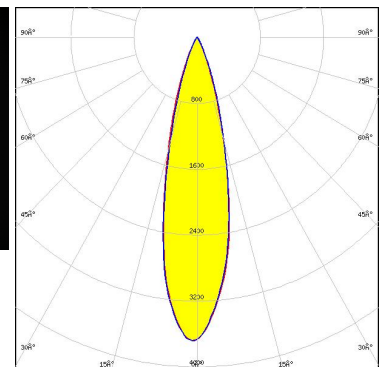
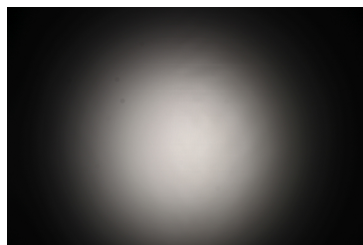

Light distribution files

OPTICAL RESULTS (MEASURED):



LED LUXEON Z ES
 FWHM / FWTM 27.0° / 49.0°
 Efficiency 85 %
 Peak intensity 3.3 cd/lm
 LEDs/each optic 1
 Light colour/type White
 Required components:

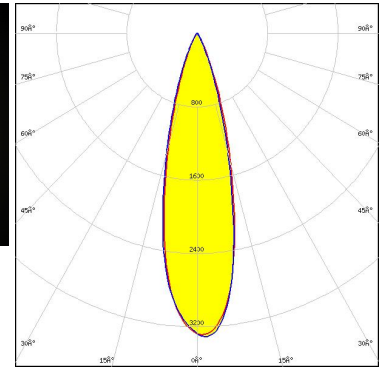
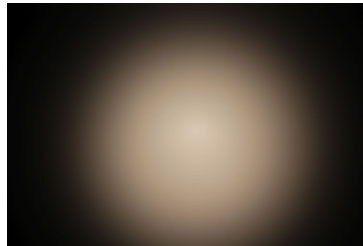

Light distribution files



LED NCSx17A
 FWHM / FWTM 23.0° / 44.0°
 Efficiency 85 %
 Peak intensity 4.1 cd/lm
 LEDs/each optic 1
 Light colour/type White
 Required components:

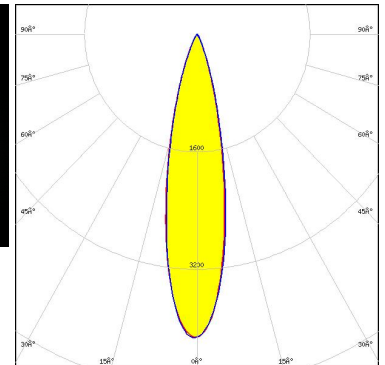
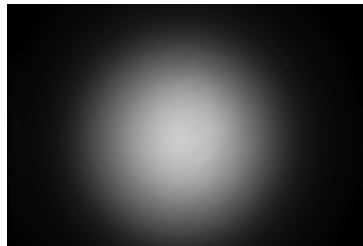

Light distribution files



LED NVSW219D
 FWHM / FWTM 31.0° / 54.0°
 Efficiency 83 %
 Peak intensity 2.4 cd/lm
 LEDs/each optic 1
 Light colour/type White
 Required components:

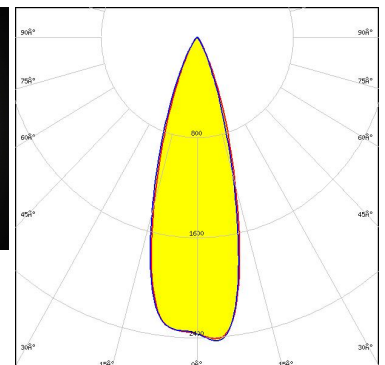
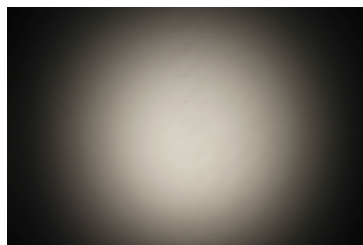

Light distribution files

OPTICAL RESULTS (MEASURED):



LED NVSW319B
 FWHM / FWTM 34.0° / 56.0°
 Efficiency 84 %
 Peak intensity 2.3 cd/lm
 LEDs/each optic 1
 Light colour/type White
 Required components:

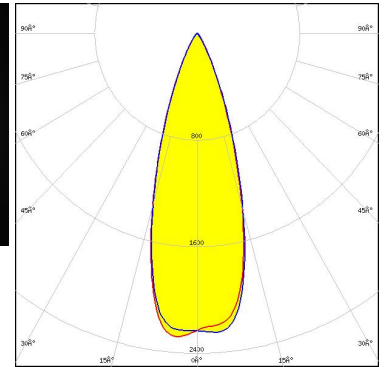

Light distribution files



LED NVSxE21A
 FWHM / FWTM 23.0° / 44.0°
 Efficiency 85 %
 Peak intensity 4.2 cd/lm
 LEDs/each optic 1
 Light colour/type White
 Required components:

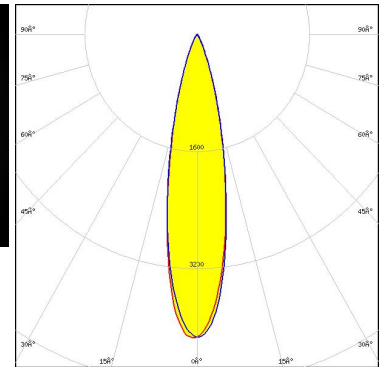

Light distribution files



LED NVSxx19B/NVSxx19C
 FWHM / FWTM 30.0° / 52.0°
 Efficiency 84 %
 Peak intensity 2.7 cd/lm
 LEDs/each optic 1
 Light colour/type White
 Required components:

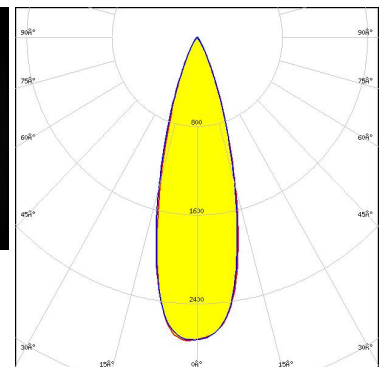
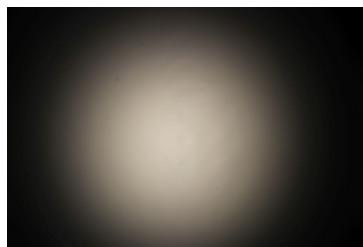

Light distribution files

OPTICAL RESULTS (MEASURED):

OSRAM
Opto Semiconductors

LED Duris S8
FWHM / FWTM 27.0° / 53.0°
Efficiency 85 %
Peak intensity 3 cd/lm
LEDs/each optic 1
Light colour/type White
Required components:

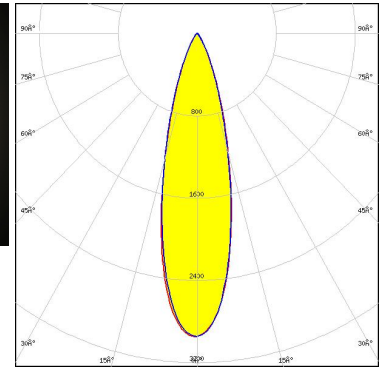
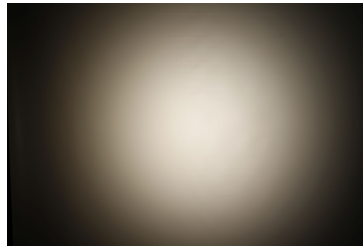

Light distribution files

OSRAM
Opto Semiconductors

LED OSCONIQ P 3737 (2W version)
FWHM / FWTM 26.0° / 49.0°
Efficiency 83 %
Peak intensity 3.2 cd/lm
LEDs/each optic 1
Light colour/type White
Required components:

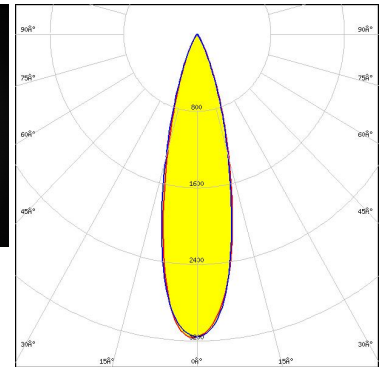
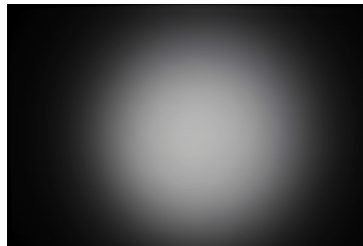

Light distribution files

OSRAM
Opto Semiconductors

LED OSCONIQ P 3737 (3W version)
FWHM / FWTM 28.0° / 51.0°
Efficiency 84 %
Peak intensity 3 cd/lm
LEDs/each optic 1
Light colour/type White
Required components:

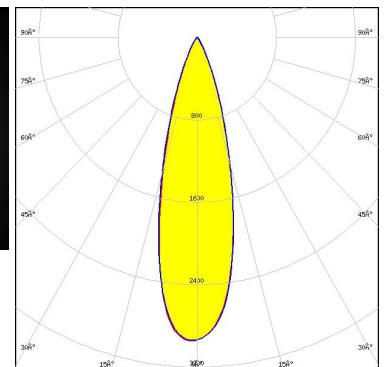
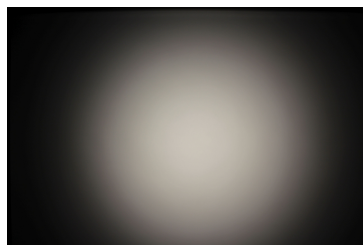

Light distribution files

OPTICAL RESULTS (MEASURED):

OSRAM
Opto Semiconductors

LED OSCONIQ P 7070
FWHM / FWTM 29.0° / 55.0°
Efficiency 83 %
Peak intensity 2.6 cd/lm
LEDs/each optic 1
Light colour/type White
Required components:

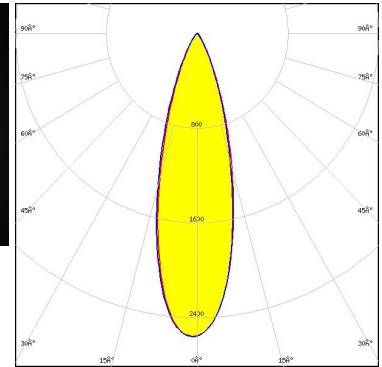
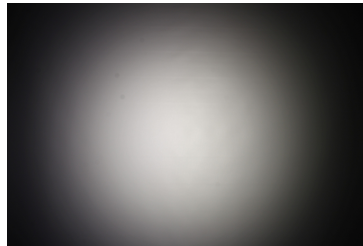

Light distribution files

OSRAM
Opto Semiconductors

LED OSLOM Black Flat (LUW HWQP)
FWHM / FWTM 24.0° / 45.0°
Efficiency 85 %
Peak intensity 3.9 cd/lm
LEDs/each optic 1
Light colour/type White
Required components:

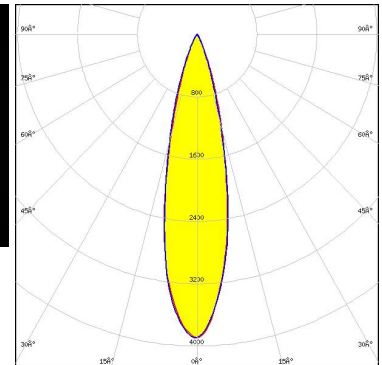
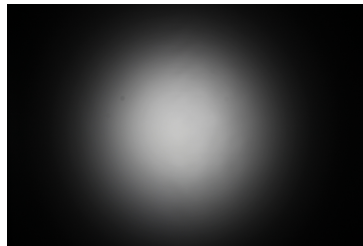

Light distribution files

OSRAM
Opto Semiconductors

LED OSLOM Square CSSRM2/CSSRM3
FWHM / FWTM 30.0° / 52.0°
Efficiency 84 %
Peak intensity 2.7 cd/lm
LEDs/each optic 1
Light colour/type White
Required components:

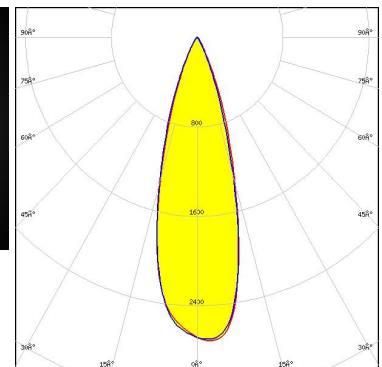
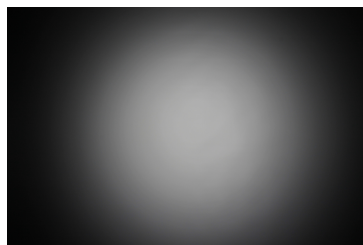

Light distribution files

OPTICAL RESULTS (MEASURED):

OSRAM
Opto Semiconductors

LED OSLON Square EC
 FWHM / FWTM 28.0° / 51.0°
 Efficiency 81 %
 Peak intensity 2.9 cd/lm
 LEDs/each optic 1
 Light colour/type White
 Required components:

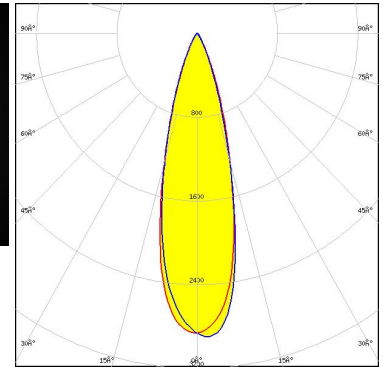
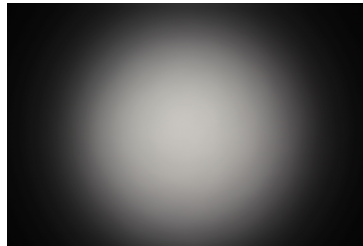

Light distribution files

OSRAM
Opto Semiconductors

LED OSLON Square PC
 FWHM / FWTM 29.0° / 52.0°
 Efficiency 82 %
 Peak intensity 2.8 cd/lm
 LEDs/each optic 1
 Light colour/type White
 Required components:

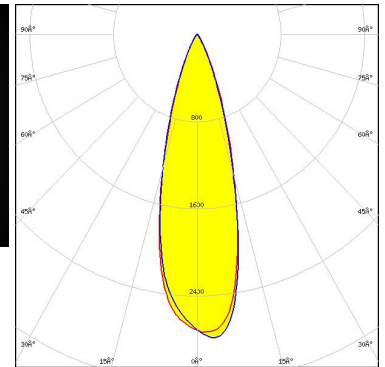
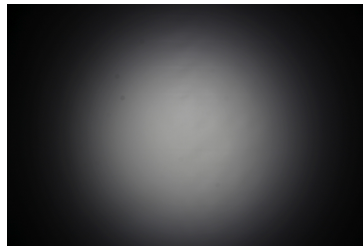

Light distribution files

OSRAM
Opto Semiconductors

LED OSLON SSL 150
 FWHM / FWTM 30.0° / 51.0°
 Efficiency 82 %
 Peak intensity 2.7 cd/lm
 LEDs/each optic 1
 Light colour/type White
 Required components:

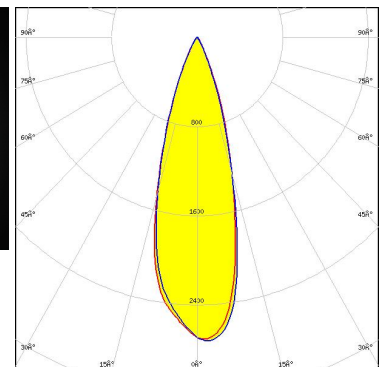
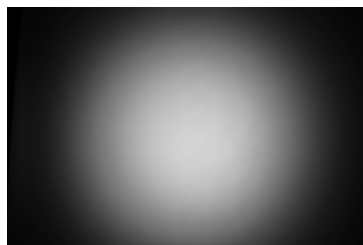

Light distribution files

OPTICAL RESULTS (MEASURED):

OSRAM
Opto Semiconductors

LED OSLON SSL 80
FWHM / FWTM 28.0° / 51.0°
Efficiency 82 %
Peak intensity 2.9 cd/lm
LEDs/each optic 1
Light colour/type White
Required components:

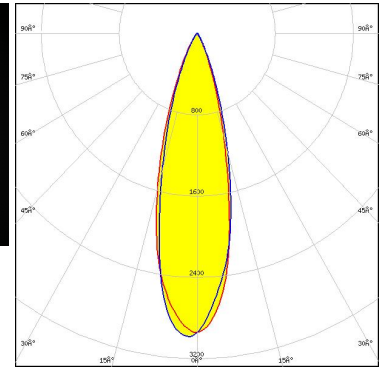
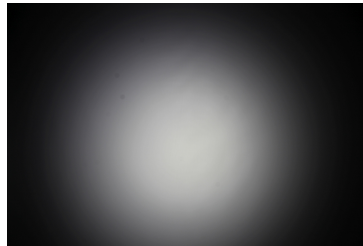

Light distribution files

OSRAM
Opto Semiconductors

LED OSTAR Stage (S2WN)
FWHM / FWTM 26.0° / 50.0°
Efficiency 84 %
Peak intensity 3.2 cd/lm
LEDs/each optic 1
Light colour/type RGBW
Required components:

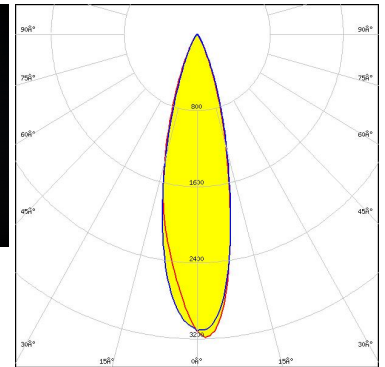
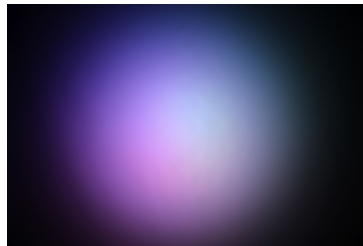

Light distribution files

SAMSUNG

LED LH181A
FWHM / FWTM 22.0° / 44.0°
Efficiency 81 %
Peak intensity 4 cd/lm
LEDs/each optic 1
Light colour/type White
Required components:

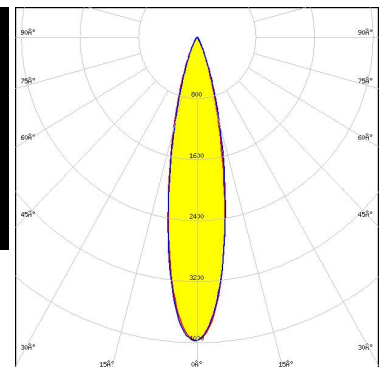
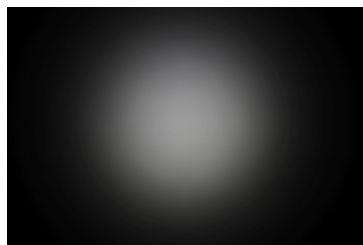

Light distribution files

OPTICAL RESULTS (MEASURED):

SAMSUNG

LED LH181B
FWHM / FWTM 23.0° / 45.0°
Efficiency 85 %
Peak intensity 3.4 cd/lm
LEDs/each optic 1
Light colour/type White
Required components:

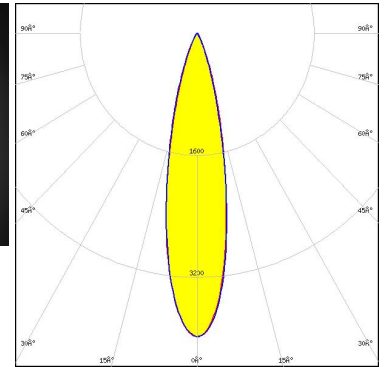

Light distribution files

SAMSUNG

LED LH231B
FWHM / FWTM 24.0° / 47.0°
Efficiency 86 %
Peak intensity 3.7 cd/lm
LEDs/each optic 1
Light colour/type White
Required components:

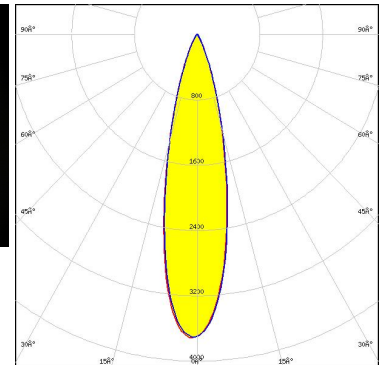
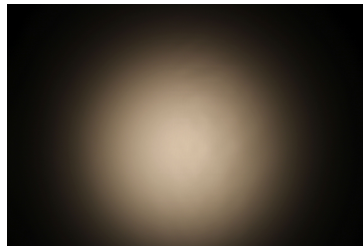

Light distribution files

SAMSUNG

LED LH351B
FWHM / FWTM 30.0° / 53.0°
Efficiency 84 %
Peak intensity 2.7 cd/lm
LEDs/each optic 1
Light colour/type White
Required components:

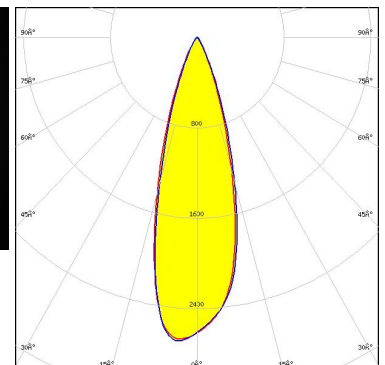
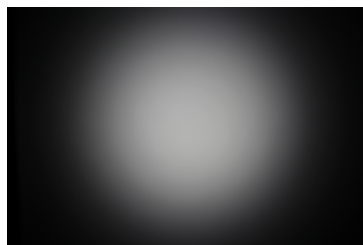

Light distribution files

OPTICAL RESULTS (MEASURED):

SAMSUNG

LED LH351C
FWHM / FWTM 31.0° / 53.0°
Efficiency 85 %
Peak intensity 2.7 cd/lm
LEDs/each optic 1
Light colour/type White
Required components:

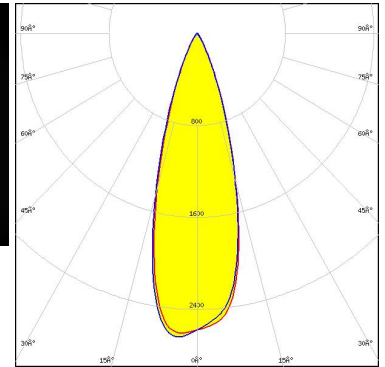
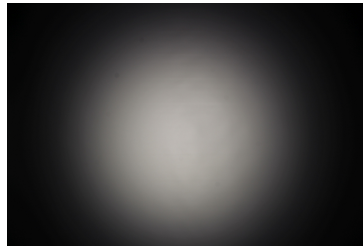

Light distribution files

SAMSUNG

LED LH351D
FWHM / FWTM 33.0° / 57.0°
Efficiency 83 %
Peak intensity 2.2 cd/lm
LEDs/each optic 1
Light colour/type White
Required components:

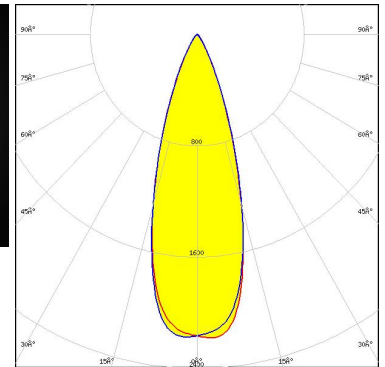
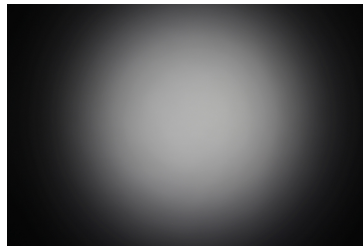

Light distribution files

SAMSUNG

LED LH508A
FWHM / FWTM 28.0° / 53.0°
Efficiency 85 %
Peak intensity 2.9 cd/lm
LEDs/each optic 1
Light colour/type White
Required components:

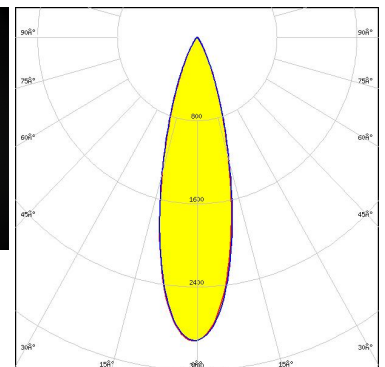
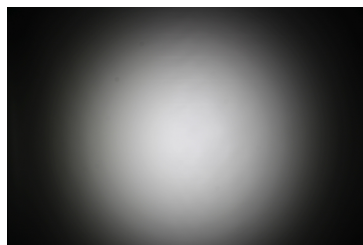

Light distribution files

OPTICAL RESULTS (MEASURED):

SAMSUNG

LED LM302A
 FWHM / FWTM 25.0° / 48.0°
 Efficiency 85 %
 Peak intensity 3.4 cd/lm
 LEDs/each optic 1
 Light colour/type White
 Required components:

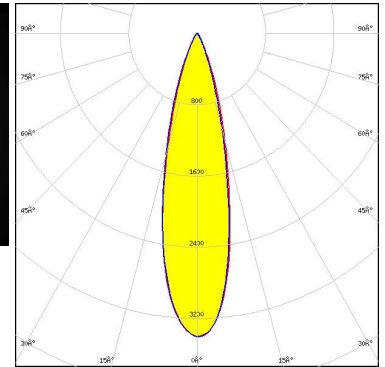
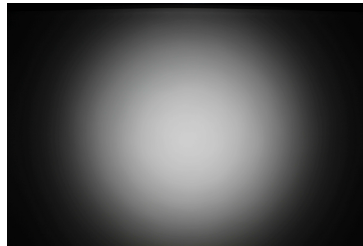

Light distribution files

SAMSUNG

LED LM561B
 FWHM / FWTM 27.0° / 51.0°
 Efficiency 85 %
 Peak intensity 3.2 cd/lm
 LEDs/each optic 1
 Light colour/type White
 Required components:

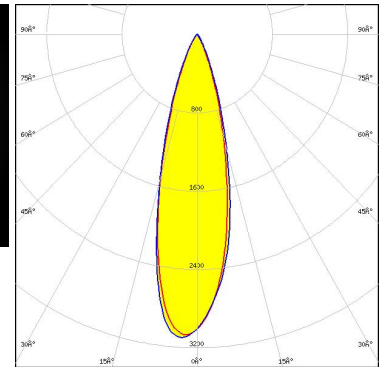
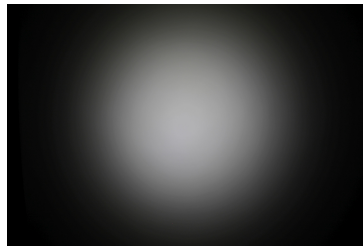

Light distribution files



LED WICOP 5050
 FWHM / FWTM 33.0° / 60.0°
 Efficiency 80 %
 Peak intensity 2.1 cd/lm
 LEDs/each optic 1
 Light colour/type White
 Required components:

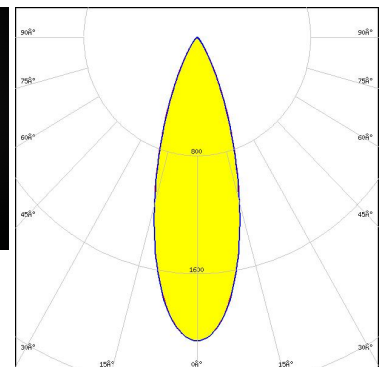
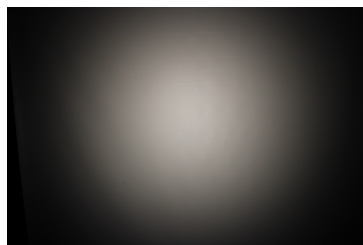

Light distribution files

OPTICAL RESULTS (MEASURED):

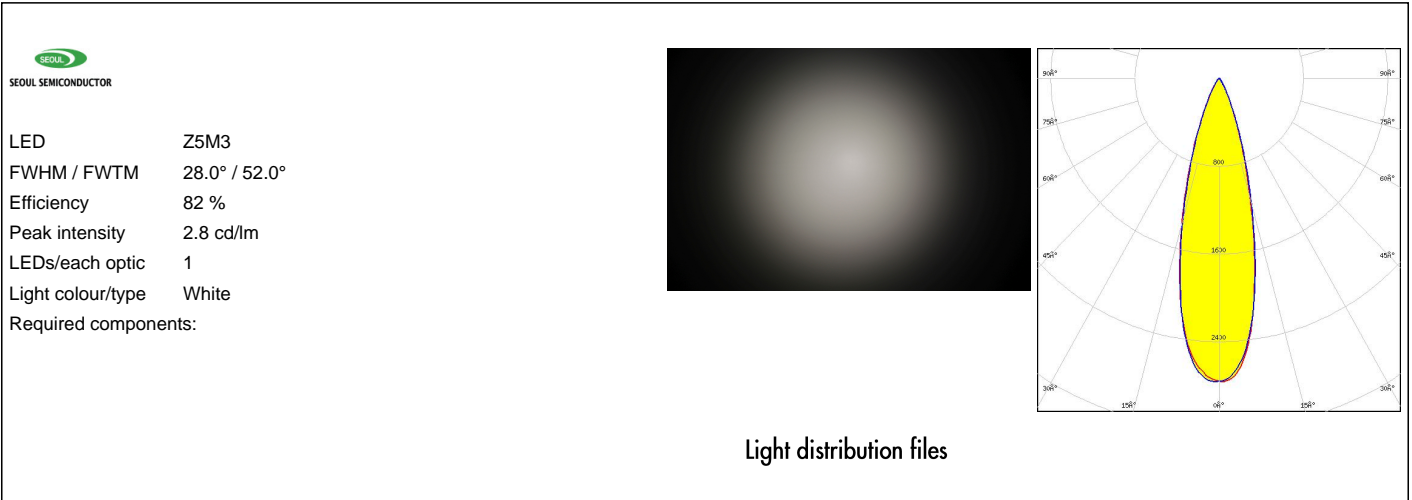

OPTICAL RESULTS (SIMULATED):



LED J Series 5050 Round LES
FWHM / FWTM 25.0° / 46.0°
Efficiency 92 %
Peak intensity 4.3 cd/lm
LEDs/each optic 1
Light colour/type White
Required components:

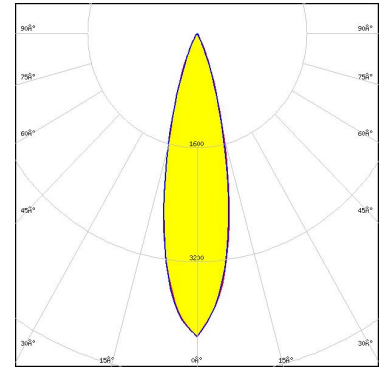

Light distribution files



LED XHP35.2 HI
FWHM / FWTM 26.0° / 46.0°
Efficiency 90 %
Peak intensity 3.8 cd/lm
LEDs/each optic 1
Light colour/type White
Required components:

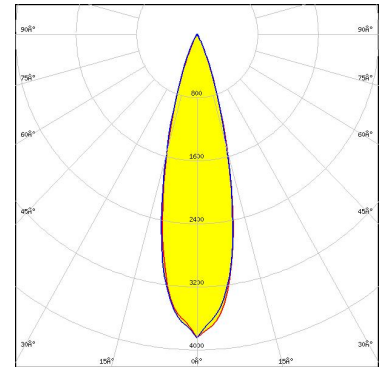

Light distribution files



LED XHP50
FWHM / FWTM 28.0° / 49.0°
Efficiency 91 %
Peak intensity 3.5 cd/lm
LEDs/each optic 1
Light colour/type White
Required components:

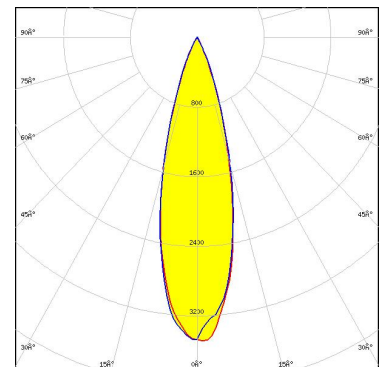

Light distribution files

OPTICAL RESULTS (SIMULATED):



LED XHP50.3 HD
FWHM / FWTM 31.0 + 30.0° / 52.0°
Efficiency 83 %
Peak intensity 2.7 cd/lm
LEDs/each optic 1
Light colour/type White
Required components:

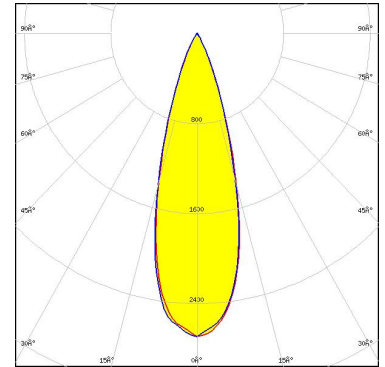

Light distribution files



LED XHP50.3 HI
FWHM / FWTM 28.0° / 48.0°
Efficiency 95 %
Peak intensity 3.4 cd/lm
LEDs/each optic 1
Light colour/type White
Required components:

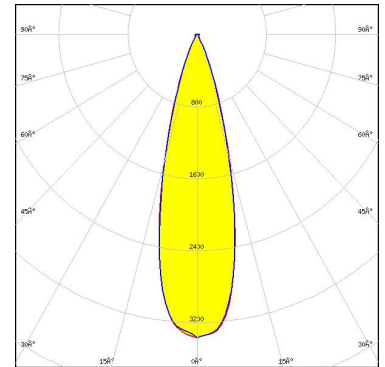

Light distribution files



LED XHP70.3 HD
FWHM / FWTM 33.0 + 32.0° / 58.0°
Efficiency 82 %
Peak intensity 2.3 cd/lm
LEDs/each optic 1
Light colour/type White
Required components:

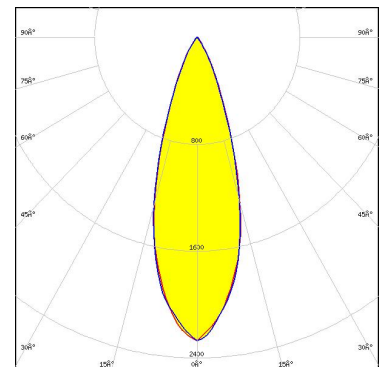

Light distribution files

OPTICAL RESULTS (SIMULATED):



LED XP-G2 HE
 FWHM / FWTM 33.0° / 50.0°
 Efficiency 89 %
 Peak intensity 2.9 cd/lm
 LEDs/each optic 1
 Light colour/type White
 Required components:

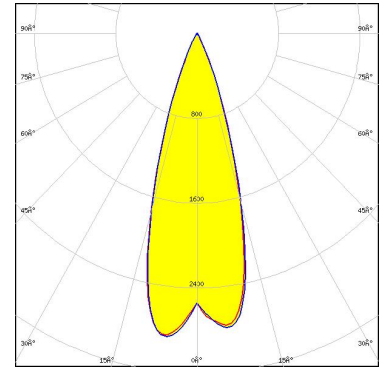

Light distribution files



LED XP-G4
 FWHM / FWTM 28.0° / 43.0°
 Efficiency 93 %
 Peak intensity 4.2 cd/lm
 LEDs/each optic 1
 Light colour/type White
 Required components:

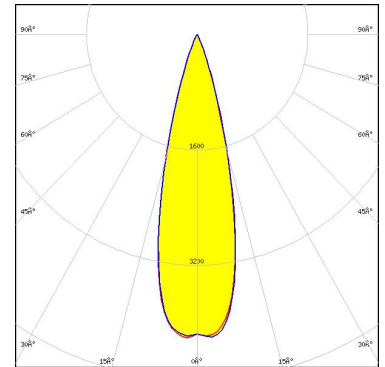

Light distribution files



LED XP-G4 HI
 FWHM / FWTM 28.0° / 46.0°
 Efficiency 89 %
 Peak intensity 3.8 cd/lm
 LEDs/each optic 1
 Light colour/type White
 Required components:

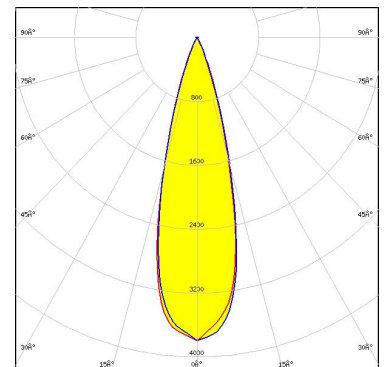

Light distribution files

OPTICAL RESULTS (SIMULATED):



LED LUXEON MZ
FWHM / FWTM 22.0° / 41.0°
Efficiency 91 %
Peak intensity 5.4 cd/lm
LEDs/each optic 1
Light colour/type White
Required components:

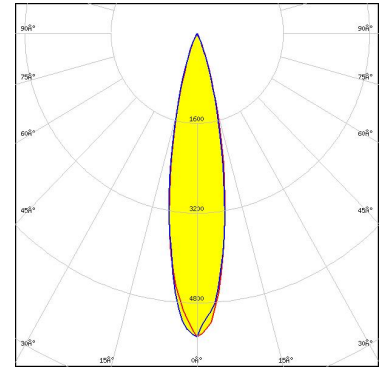

Light distribution files



LED SST-20 Gen1
FWHM / FWTM 26.0° / 42.0°
Efficiency 91 %
Peak intensity 4.5 cd/lm
LEDs/each optic 1
Light colour/type White
Required components:

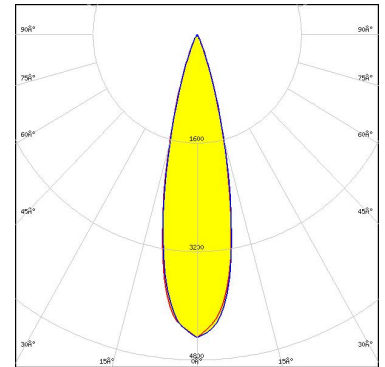

Light distribution files



LED SST-20 Gen2
FWHM / FWTM 26.0° / 43.0 + 42.0°
Efficiency 90 %
Peak intensity 4.3 cd/lm
LEDs/each optic 1
Light colour/type White
Required components:

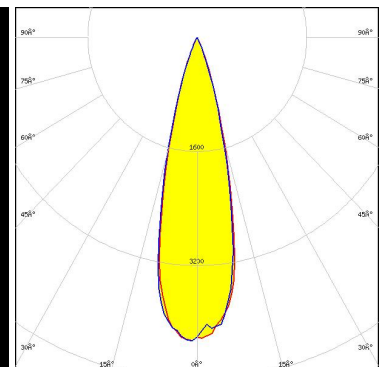

Light distribution files

OPTICAL RESULTS (SIMULATED):



LED SST-70X-WCS
FWHM / FWTM 30.0° / 50.0 + 48.0°
Efficiency 85 %
Peak intensity 3.1 cd/lm
LEDs/each optic 1
Light colour/type White
Required components:

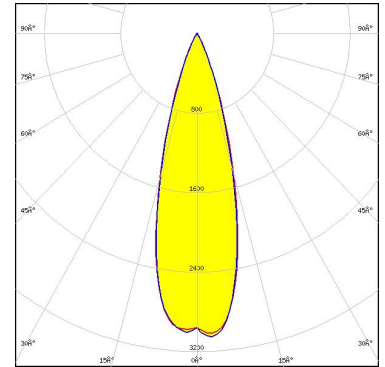

Light distribution files



LED NCSxE17A
FWHM / FWTM 24.0° / 44.0°
Efficiency 88 %
Peak intensity 4.5 cd/lm
LEDs/each optic 4
Light colour/type White
Required components:

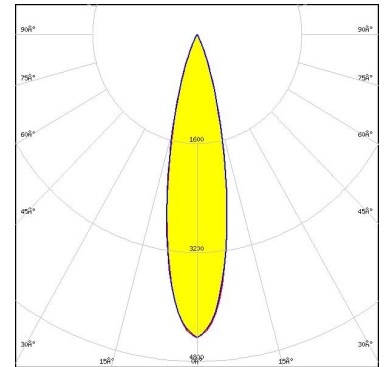

Light distribution files



LED NFMW48xA
FWHM / FWTM 25.0° / 47.0°
Efficiency 92 %
Peak intensity 4.3 cd/lm
LEDs/each optic 1
Light colour/type White
Required components:

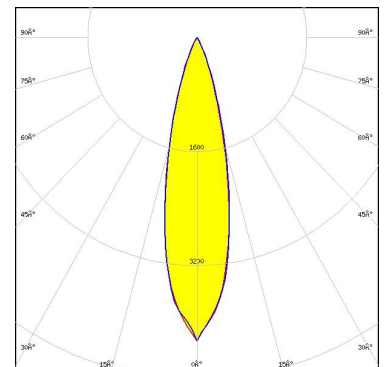

Light distribution files

OPTICAL RESULTS (SIMULATED):

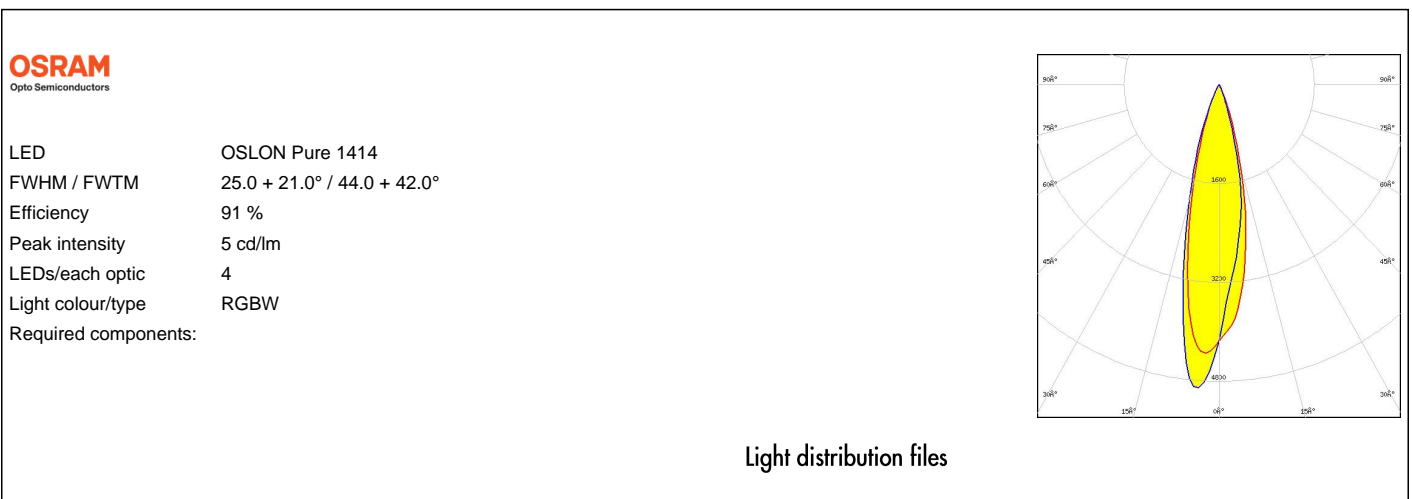
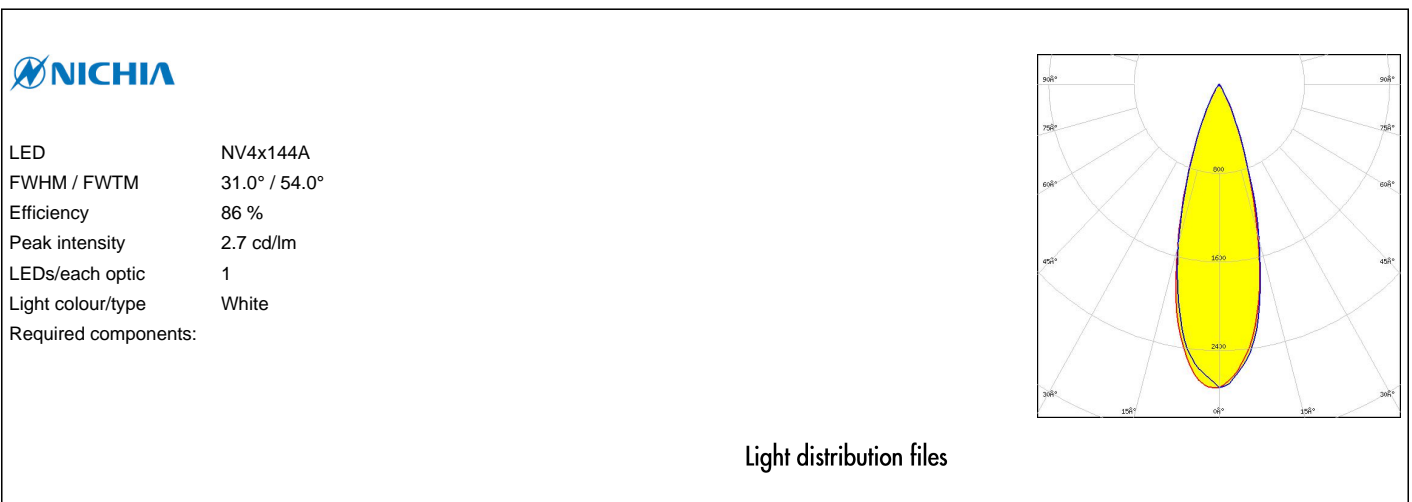
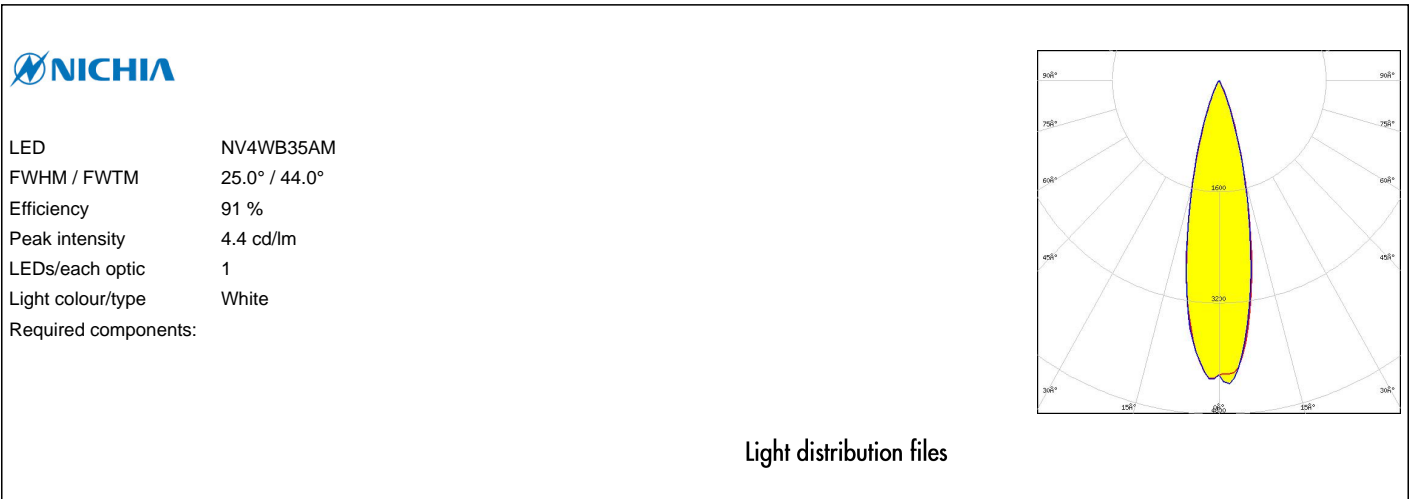

OPTICAL RESULTS (SIMULATED):

OSRAM
Osram Semiconductors

LED OSLON Pure 1414
FWHM / FWTM 24.0° / 40.0°
Efficiency 91 %
Peak intensity 5 cd/lm
LEDs/each optic 1
Light colour/type White
Required components:

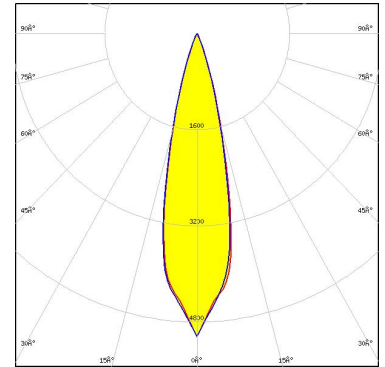

Light distribution files

SEOL
SEOUL SEMICONDUCTOR

LED Z5M3-E1
FWHM / FWTM 30.0° / 46.0°
Efficiency 93 %
Peak intensity 3.6 cd/lm
LEDs/each optic 1
Light colour/type White
Required components:

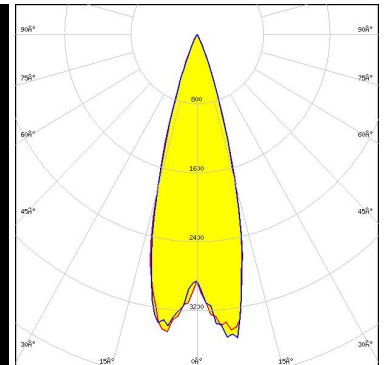

Light distribution files

GENERAL INFORMATION:

NOTE: The typical beam angle will be changed by different color, chip size and chip position tolerance. The typical total beam angle is the full angle measured where the luminous intensity is half of the peak value.

MATERIALS:

As part of our continuous research and improvement processes, and to ensure the best possible quality and availability of our products, LEDiL reserves the right to change material grades without notice.

PRODUCT DATA USER AGREEMENT AND DISCLAIMER:

The measured data in the provided downloadable LEDiL Product Datasheets and Mechanical 2D-Drawings is rounded and provided as reference for planning. LEDiL Oy's optical specifications have been verified by conducting performance testing of the products in accordance with the company's quality system. The reported data are averaged results of multiple measurements with typical variation. LEDiL Oy reserves the right to without prior notification make changes and improvements to its products.

LEDiL Oy assumes neither warranty, nor guarantee nor any other liability of any kind for the contents and correctness of the provided data. The provided data has been generated with highest diligence but the provided data may in reality not represent the complete possible variation range of all intrinsic parameters. Therefore, in certain cases a deviation from the provided data could occur.

LEDiL Oy reserves the right to undertake technical changes of its products without further notification which could lead to changes in the provided data. LEDiL Oy assumes no liability of any kind for the possible deviation from any provided data or any other damage resulting from the usage of the provided data.

The user agrees to this disclaimer and user agreement with the download or usage of the provided files.

LEDiL Oy

Joensuunkatu 7
FI-24240 SALO
Finland

LEDiL Inc.

228 West Page Street
Suite D
Sycamore IL 60178
USA

Ledil Optics Technology (Shenzhen) Co., Ltd.

405 , Block B
Casic Motor Building
Shenzhen 518057
P.R.CHINA

Local sales and technical support

[www.ledil.com/
where_to_buy](http://www.ledil.com/where_to_buy)

Shipping locations

Poznan, Poland
Hong Kong, China

Distribution Partners

[www.ledil.com/
where_to_buy](http://www.ledil.com/where_to_buy)