

SEANNA-A

~2.3° spot beam. Assembly with holder.

SPECIFICATION:

Dimensions	Ø 155.2 mm
Height	82 mm
Fastening	pin, screw
ROHS compliant	yes ⓘ

MATERIALS:

Component	Type	Material	Colour	Finish	Length (mm)
SEANNA-FRES	Single lens	PMMA	clear		
SEANNA-A	Single lens	PMMA	clear		
SEANNA-HLD-B-BOTTOMRING	Holder	PA66GF30	black		
SEANNA-HLD-B-TOPRING	Holder	PA66GF30	black		
SEANNA-HLD-B	Holder	PA66GF30	black		
SEANNA-SCREW	Accessory	Stainless steel	clear		



ORDERING INFORMATION:

Component	Qty in box	MOQ	MPQ	Box weight (kg)
FCP13895_SEANNA-A		20	2	6.5
» Box size:				

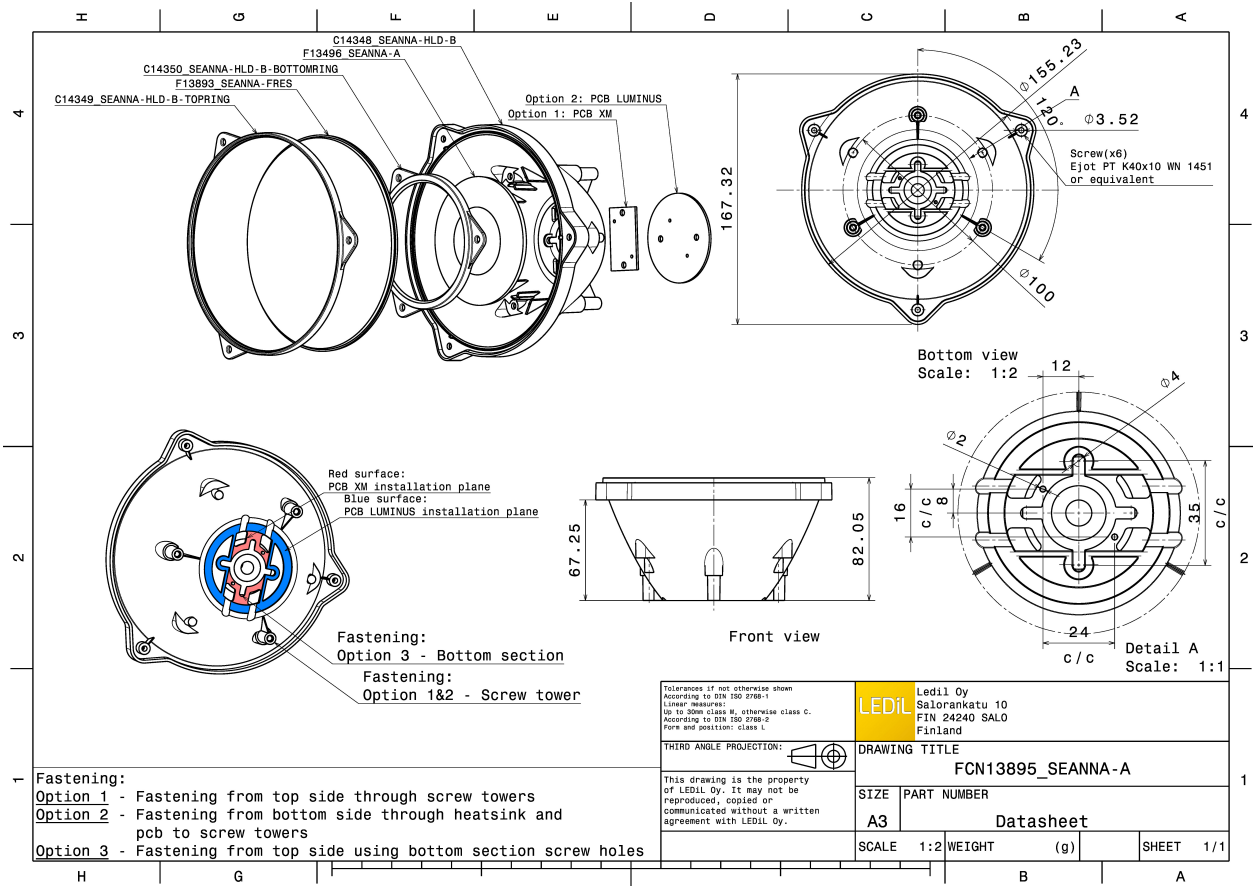

See also our general installation guide: www.ledil.com/installation_guide

OPTICAL RESULTS (MEASURED):



LED XD16
FWHM / FWTM 1.0° / 3.0°
Efficiency 91 %
Peak intensity 629 cd/lm
LEDs/each optic 1
Light colour/type White
Required components:

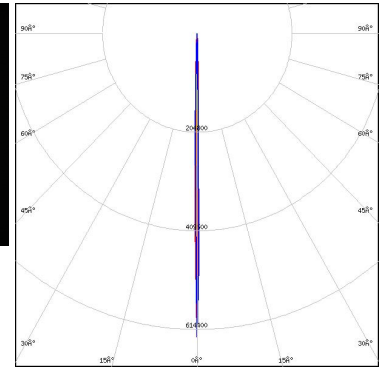
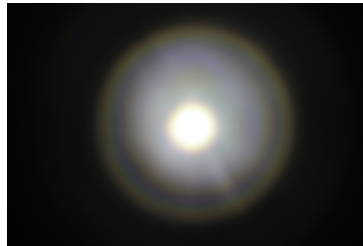

Light distribution files



LED XP-E2
FWHM / FWTM 1.0° / 3.0°
Efficiency %
Peak intensity 718 cd/lm
LEDs/each optic 1
Light colour/type White
Required components:

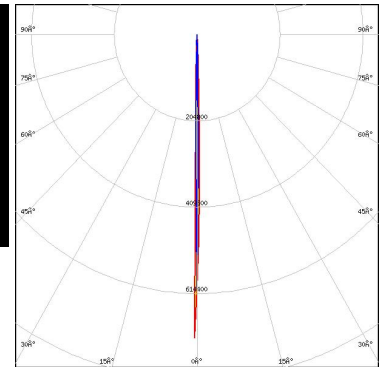
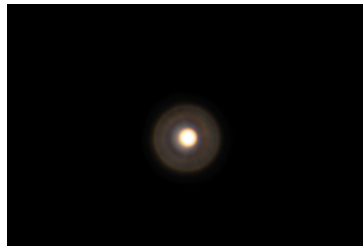

Light distribution files



LED XP-L HD
FWHM / FWTM 2.4° / 5.3°
Efficiency 94 %
Peak intensity 255 cd/lm
LEDs/each optic 1
Light colour/type White
Required components:

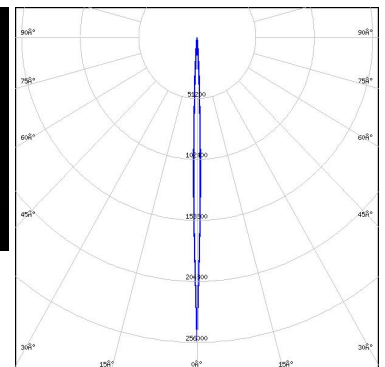

Light distribution files

OPTICAL RESULTS (MEASURED):



LED XP-L HI
 FWHM / FWTM 1.6° / 3.2°
 Efficiency 94 %
 Peak intensity 492 cd/lm
 LEDs/each optic 1
 Light colour/type White
 Required components:

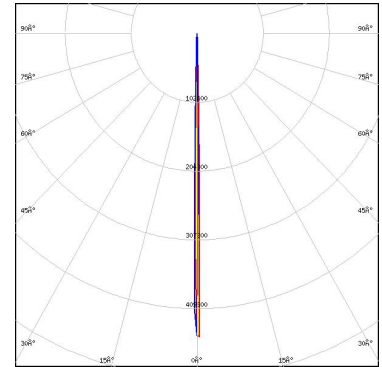

Light distribution files



LED NVSW3x9A
 FWHM / FWTM 1.9° / 4.1°
 Efficiency 92 %
 Peak intensity 310 cd/lm
 LEDs/each optic 1
 Light colour/type White
 Required components:

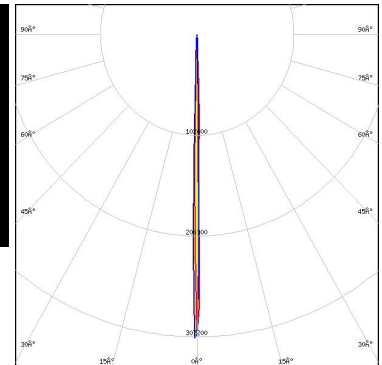
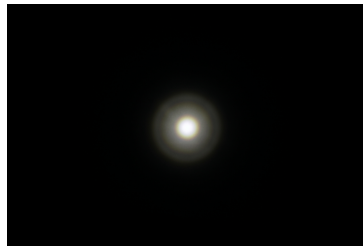

Light distribution files



LED OSLOM Black Flat (LUW HWQP)
 FWHM / FWTM 1.2° / 2.3°
 Efficiency 94 %
 Peak intensity 1196 cd/lm
 LEDs/each optic 1
 Light colour/type White
 Required components:

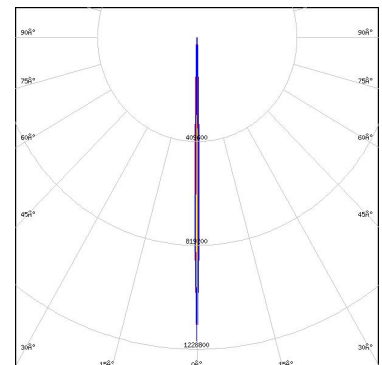

Light distribution files

OPTICAL RESULTS (MEASURED):

OSRAM
Opto Semiconductors

LED OSLON Square CSSRM2/CSSRM3
FWHM / FWTM 1.5° / 3.3°
Efficiency 94 %
Peak intensity 587 cd/lm
LEDs/each optic 1
Light colour/type White
Required components:

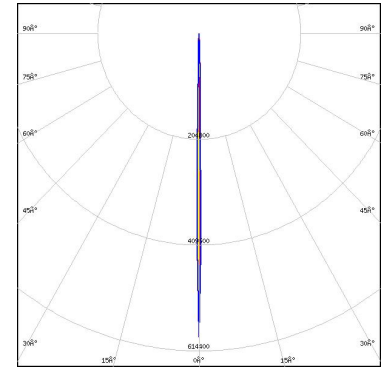

Light distribution files

OPTICAL RESULTS (SIMULATED):



LED MK-R
FWHM / FWTM 4.0° / 10.4°
Efficiency 91 %
Peak intensity 82 cd/lm
LEDs/each optic 1
Light colour/type White
Required components:

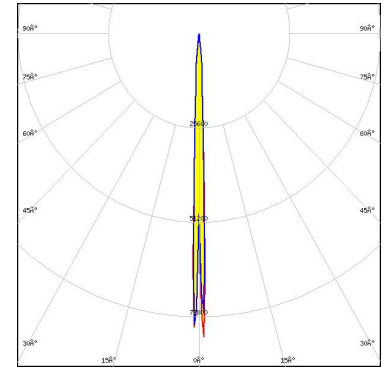

Light distribution files



LED XB-D
FWHM / FWTM 1.3° / 3.2°
Efficiency 87 %
Peak intensity 698 cd/lm
LEDs/each optic 1
Light colour/type White
Required components:

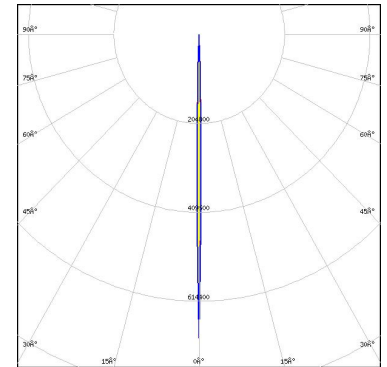

Light distribution files



LED XHP35 HD
FWHM / FWTM 2.4° / 4.2°
Efficiency 89 %
Peak intensity 257 cd/lm
LEDs/each optic 1
Light colour/type White
Required components:

OPTICAL RESULTS (SIMULATED):



LED XHP35 HI
FWHM / FWTM 1.6° / 3.6°
Efficiency 83 %
Peak intensity 496 cd/lm
LEDs/each optic 1
Light colour/type White
Required components:

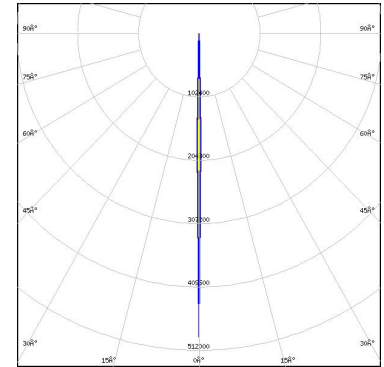

Light distribution files



LED XHP35.2 HD
FWHM / FWTM 2.0° / 6.0°
Efficiency 89 %
Peak intensity 161.9 cd/lm
LEDs/each optic 1
Light colour/type White
Required components:

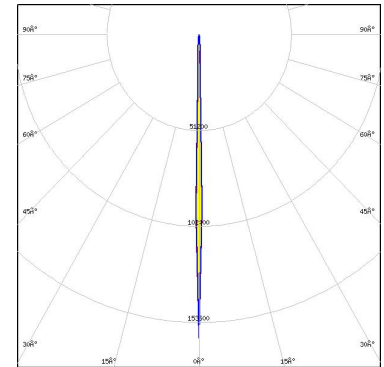

Light distribution files



LED XHP35.2 HI
FWHM / FWTM 2.0° / 4.0°
Efficiency 89 %
Peak intensity 161 cd/lm
LEDs/each optic 1
Light colour/type White
Required components:

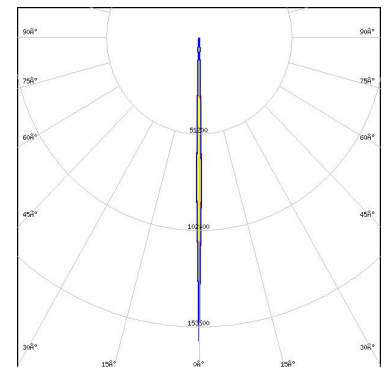

Light distribution files

OPTICAL RESULTS (SIMULATED):



LED XHP50
FWHM / FWTM 3.3° / 6.7°
Efficiency 87 %
Peak intensity 122 cd/lm
LEDs/each optic 1
Light colour/type White
Required components:

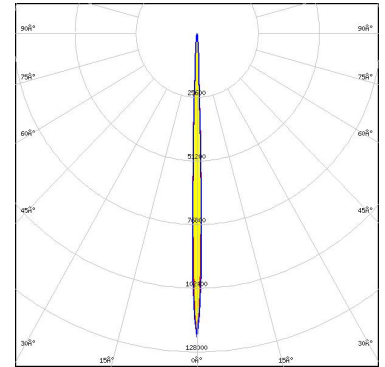

Light distribution files



LED XHP50.2
FWHM / FWTM 2.7° / 6.8°
Efficiency 84 %
Peak intensity 128.7 cd/lm
LEDs/each optic 1
Light colour/type White
Required components:

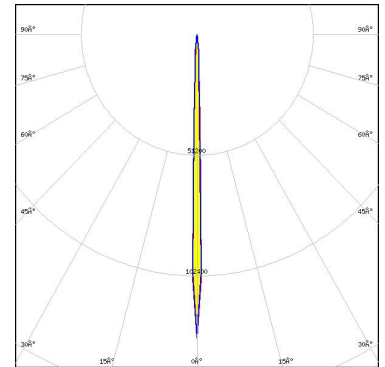

Light distribution files



LED XHP70
FWHM / FWTM 4.3° / 10.4°
Efficiency 81 %
Peak intensity 69.9 cd/lm
LEDs/each optic 1
Light colour/type White
Required components:

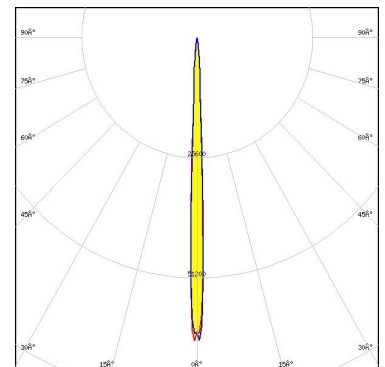

Light distribution files

OPTICAL RESULTS (SIMULATED):



LED XHP70.2
FWHM / FWTM 4.5° / 10.1°
Efficiency 83 %
Peak intensity 71.6 cd/lm
LEDs/each optic 1
Light colour/type White
Required components:

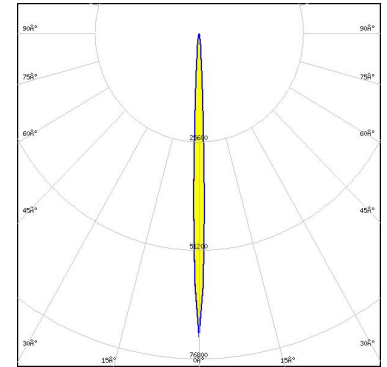

Light distribution files



LED XHP70.3 HI
FWHM / FWTM 4.0° / 8.0°
Efficiency 80 %
Peak intensity 103.3 cd/lm
LEDs/each optic 1
Light colour/type White
Required components:

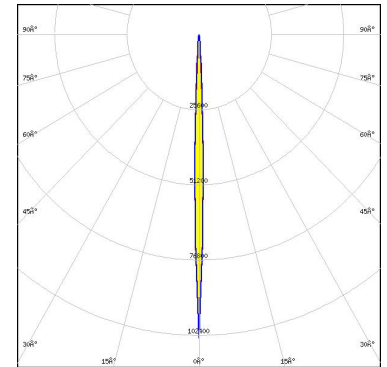

Light distribution files



LED XM-L
FWHM / FWTM 2.4°
Efficiency %
Peak intensity 272 cd/lm
LEDs/each optic 1
Light colour/type White
Required components:

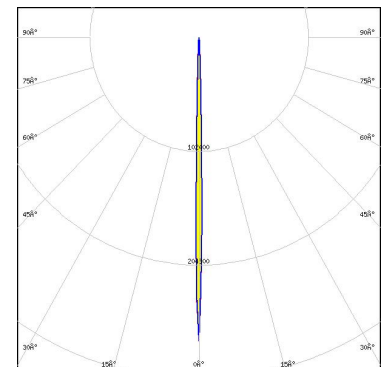

Light distribution files

OPTICAL RESULTS (SIMULATED):



LED XM-L2
 FWHM / FWTM 2.0° / 3.9°
 Efficiency 85 %
 Peak intensity 275 cd/lm
 LEDs/each optic 1
 Light colour/type White
 Required components:

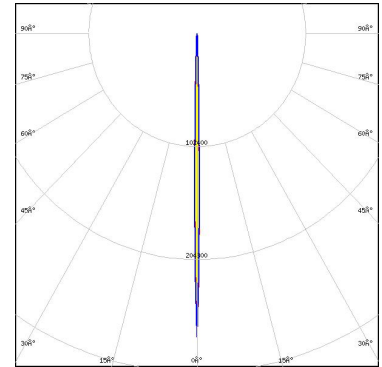

Light distribution files



LED XM-L3
 FWHM / FWTM 2.0° / 6.0°
 Efficiency 90 %
 Peak intensity 196.2 cd/lm
 LEDs/each optic 1
 Light colour/type White
 Required components:

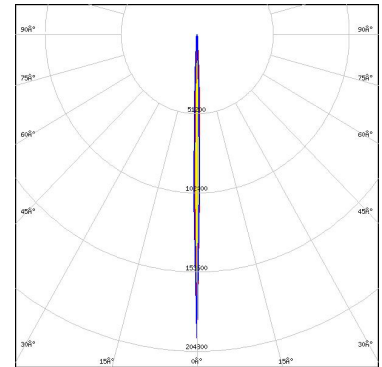

Light distribution files



LED XP-E
 FWHM / FWTM 1.2° / 2.9°
 Efficiency 92 %
 Peak intensity 955 cd/lm
 LEDs/each optic 1
 Light colour/type White
 Required components:

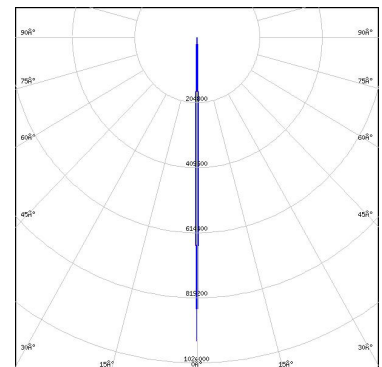

Light distribution files

OPTICAL RESULTS (SIMULATED):



LED XP-E2
 FWHM / FWTM 2.0° / 6.0°
 Efficiency 85 %
 Peak intensity 211.5 cd/lm
 LEDs/each optic 1
 Light colour/type Blue
 Required components:

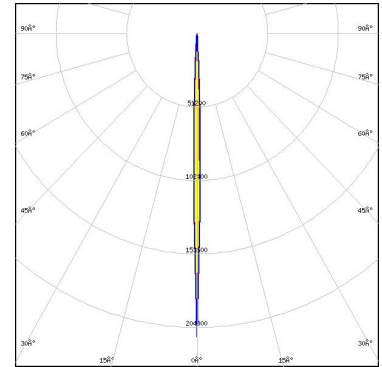

Light distribution files



LED XP-G
 FWHM / FWTM 1.4° / 3.4°
 Efficiency 90 %
 Peak intensity 578 cd/lm
 LEDs/each optic 1
 Light colour/type White
 Required components:

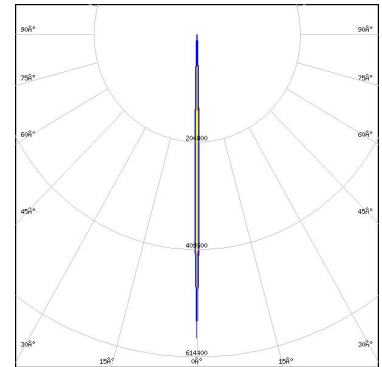

Light distribution files



LED XP-G2
 FWHM / FWTM 1.4° / 3.2°
 Efficiency 91 %
 Peak intensity 628 cd/lm
 LEDs/each optic 1
 Light colour/type White
 Required components:

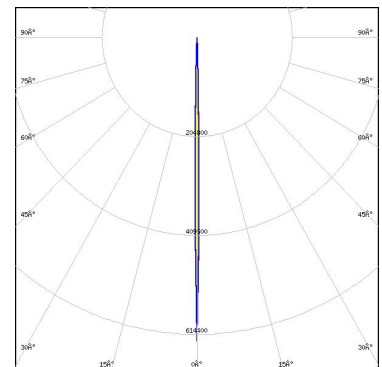

Light distribution files

OPTICAL RESULTS (SIMULATED):



LED XP-G2 HE
 FWHM / FWTM 2.0° / 4.0°
 Efficiency 89 %
 Peak intensity 286.5 cd/lm
 LEDs/each optic 1
 Light colour/type White
 Required components:

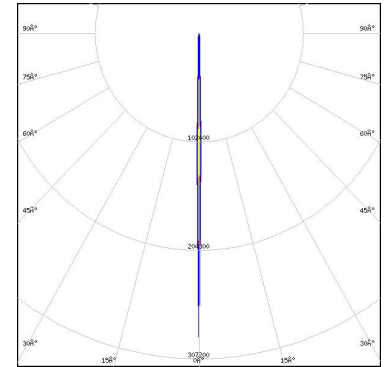

Light distribution files



LED XP-G3
 FWHM / FWTM 2.0° / 4.0°
 Efficiency 88 %
 Peak intensity 246.2 cd/lm
 LEDs/each optic 1
 Light colour/type White
 Required components:

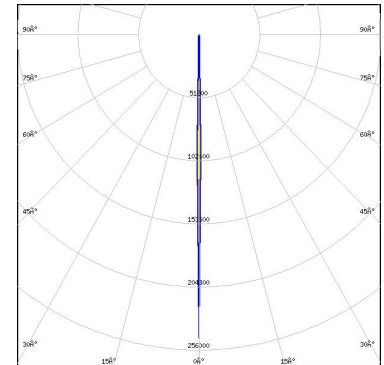

Light distribution files



LED XP-P
 FWHM / FWTM 2.0° / 6.0°
 Efficiency 84 %
 Peak intensity 246.8 cd/lm
 LEDs/each optic 1
 Light colour/type White
 Required components:

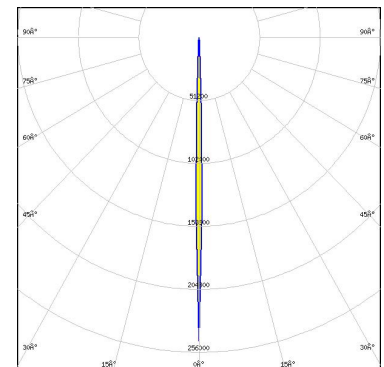

Light distribution files

OPTICAL RESULTS (SIMULATED):



LED XQ-E HD
 FWHM / FWTM 1.1° / 2.5°
 Efficiency 92 %
 Peak intensity 1460 cd/lm
 LEDs/each optic 1
 Light colour/type White
 Required components:

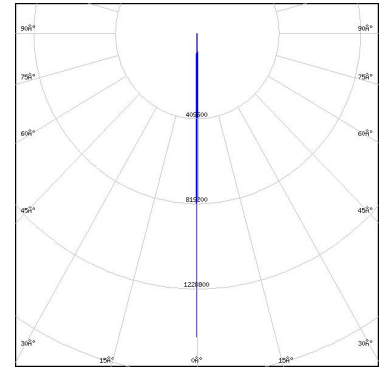

Light distribution files



LED XQ-E HI
 FWHM / FWTM 1.2° / 2.0°
 Efficiency 90 %
 Peak intensity 1300 cd/lm
 LEDs/each optic 1
 Light colour/type White
 Required components:



LED XT-E
 FWHM / FWTM 1.4° / 3.5°
 Efficiency 88 %
 Peak intensity 519 cd/lm
 LEDs/each optic 1
 Light colour/type White
 Required components:

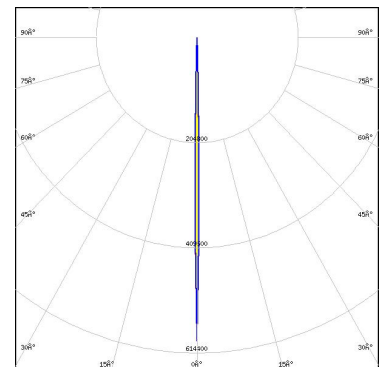

Light distribution files

OPTICAL RESULTS (SIMULATED):



LED LZ4 (00xW00)
FWHM / FWTM 3.3° / 8.2°
Efficiency 91 %
Peak intensity 136 cd/lm
LEDs/each optic 1
Light colour/type White
Required components:

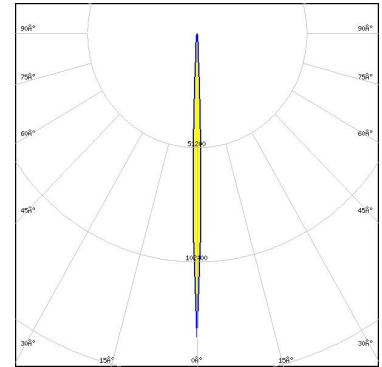

Light distribution files



LED LUXEON CZ
FWHM / FWTM 1.4° / 3.7°
Efficiency 94 %
Peak intensity 424 cd/lm
LEDs/each optic 1
Light colour/type Green
Required components:

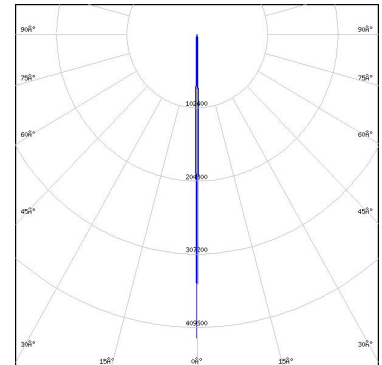

Light distribution files



LED LUXEON CZ
FWHM / FWTM 1.2° / 3.3°
Efficiency 94 %
Peak intensity 564 cd/lm
LEDs/each optic 1
Light colour/type Red
Required components:

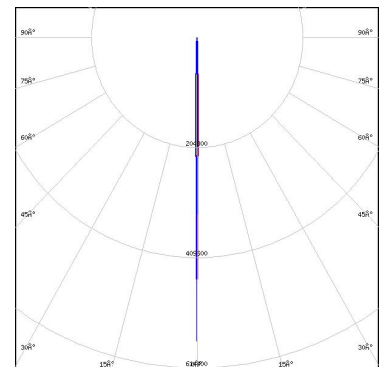

Light distribution files

OPTICAL RESULTS (SIMULATED):



LED LUXEON CZ
FWHM / FWTM 1.3° / 3.4°
Efficiency 94 %
Peak intensity 564 cd/lm
LEDs/each optic 1
Light colour/type PC Amber
Required components:

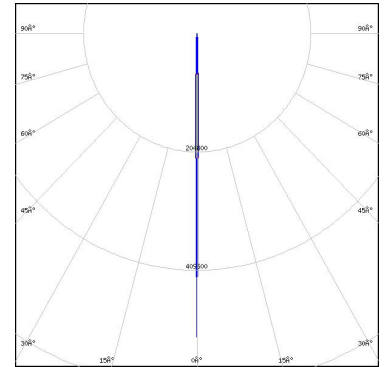

Light distribution files



LED LUXEON CZ
FWHM / FWTM 1.7° / 3.9°
Efficiency 93 %
Peak intensity 346 cd/lm
LEDs/each optic 1
Light colour/type White
Required components:

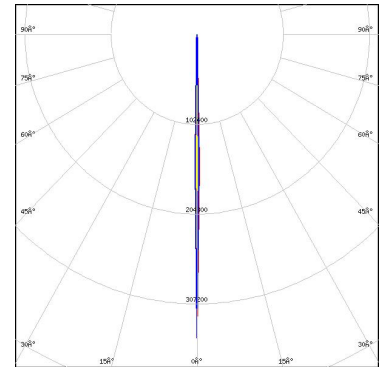

Light distribution files



LED LUXEON CZ
FWHM / FWTM 1.6° / 3.8°
Efficiency 93 %
Peak intensity 371 cd/lm
LEDs/each optic 1
Light colour/type Blue
Required components:

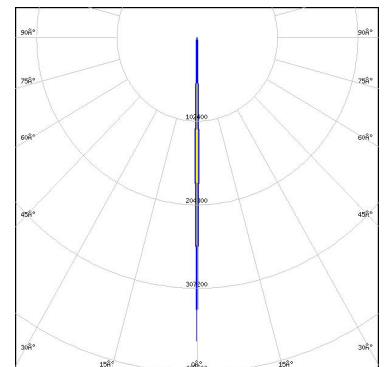

Light distribution files

OPTICAL RESULTS (SIMULATED):

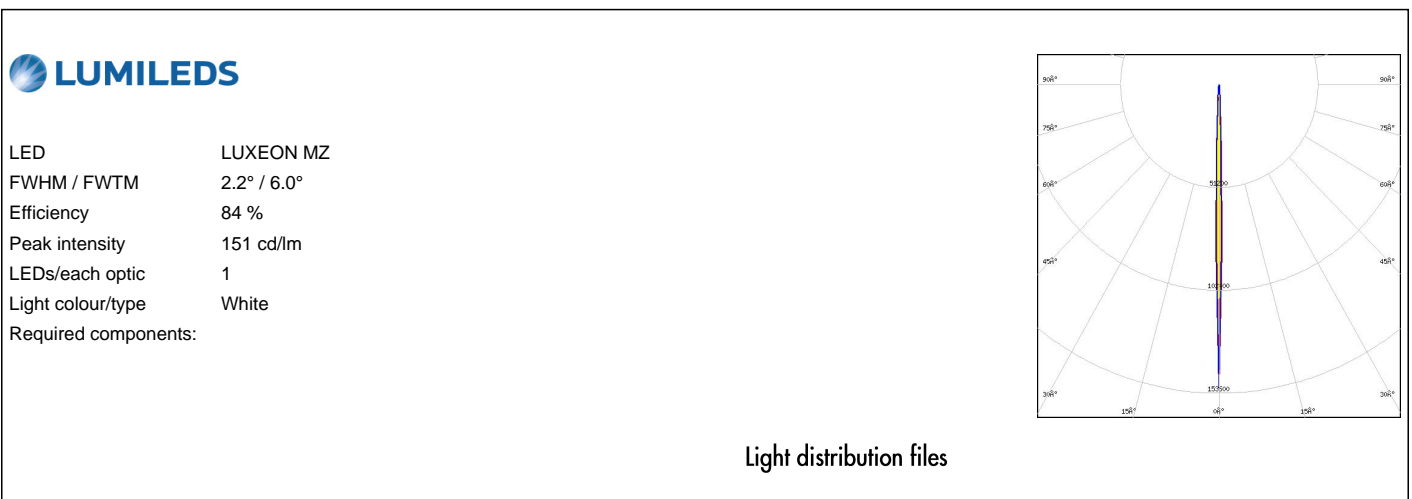
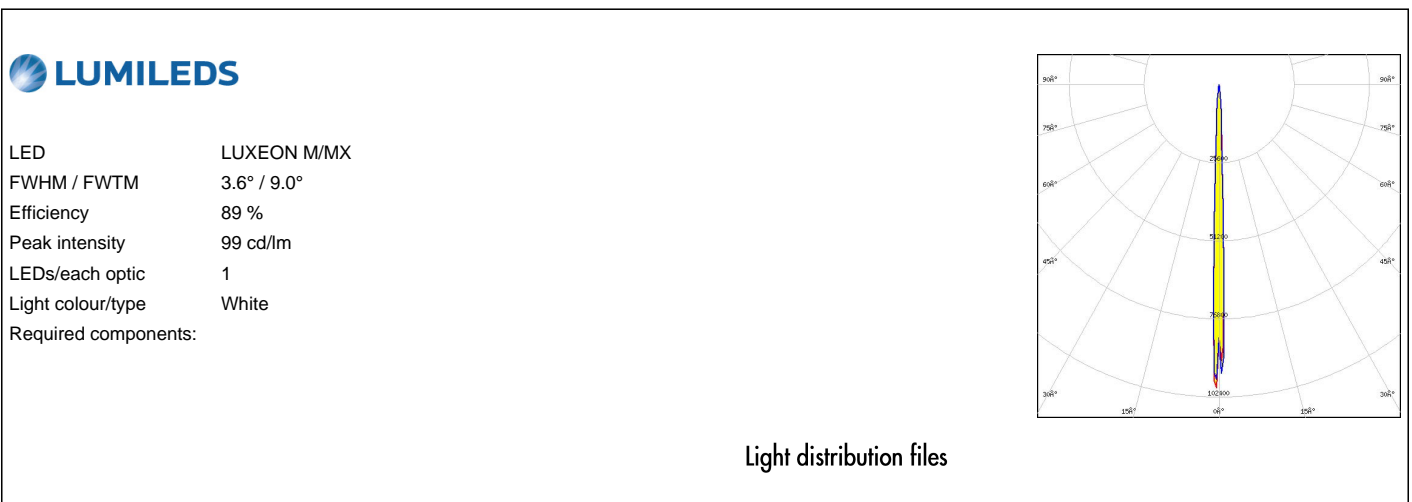
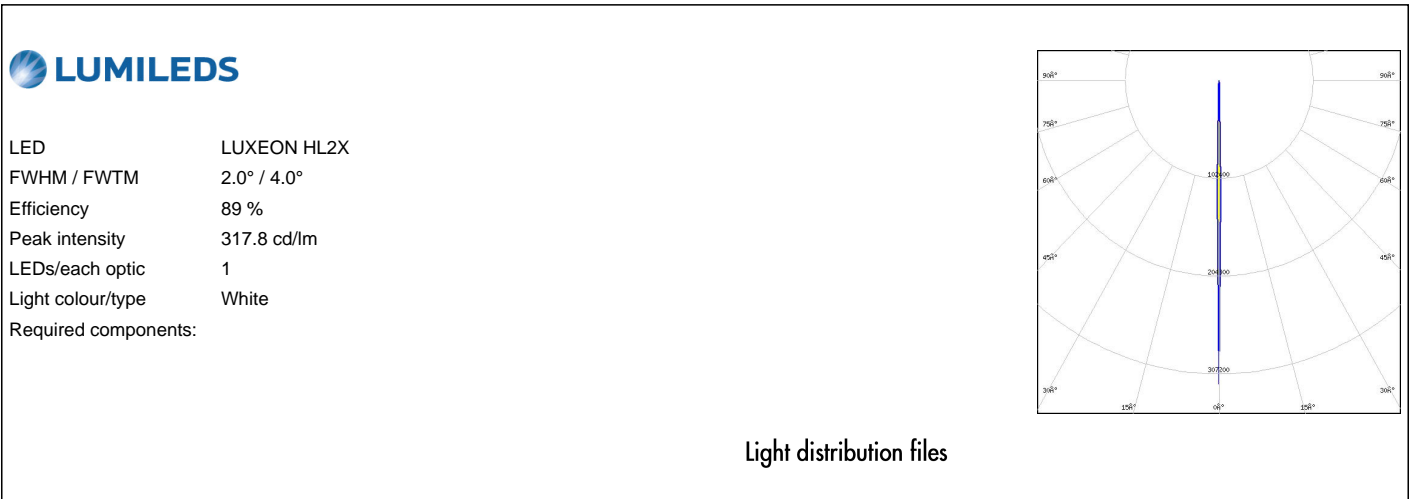

OPTICAL RESULTS (SIMULATED):

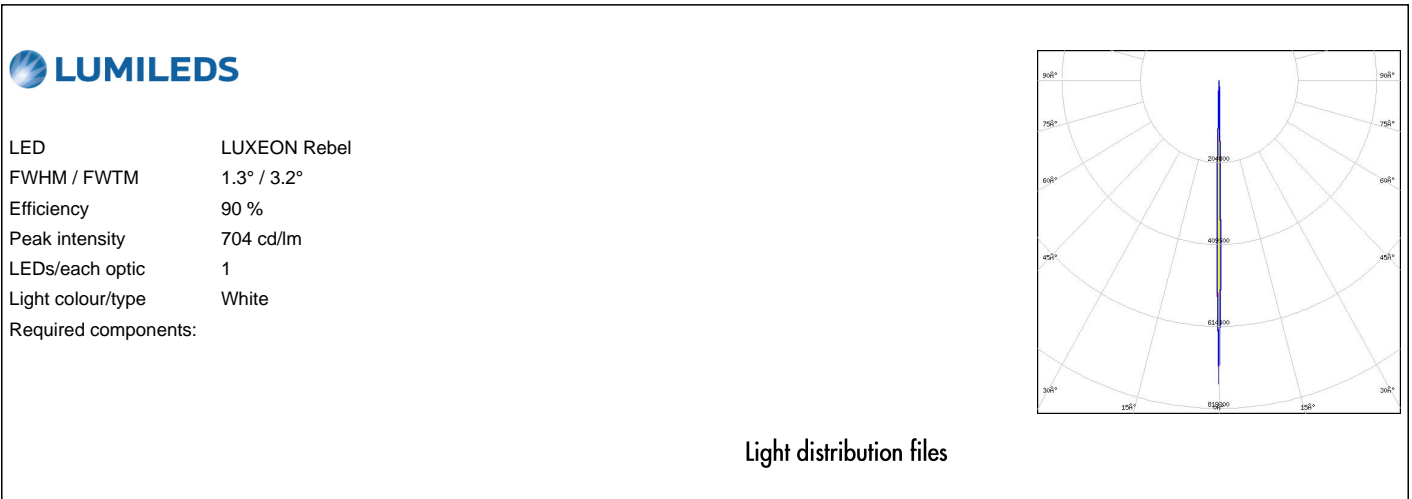

OPTICAL RESULTS (SIMULATED):

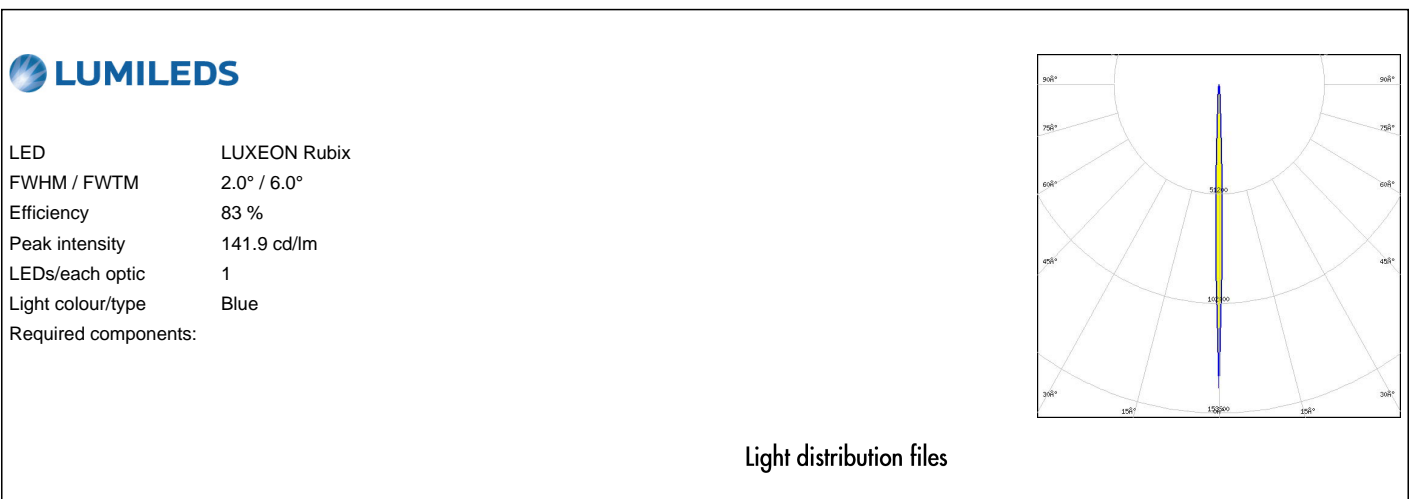
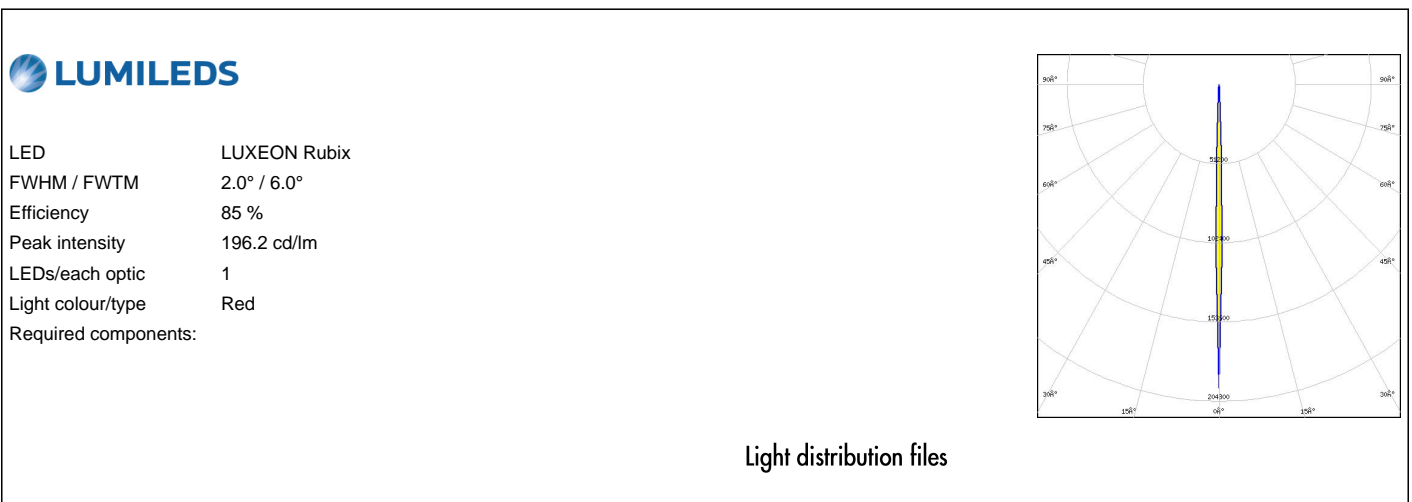
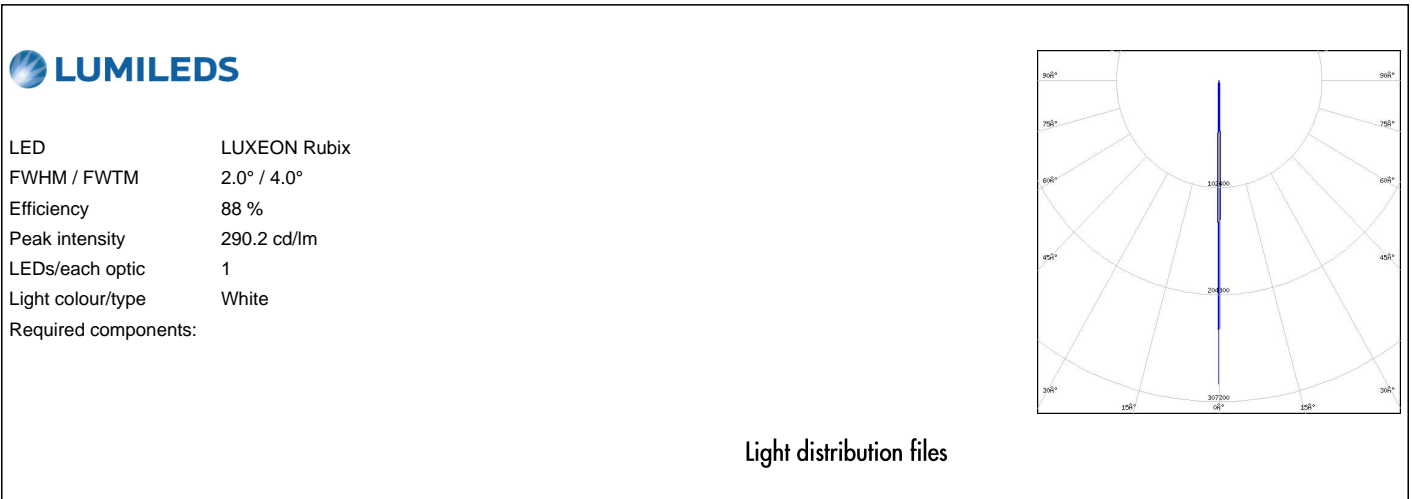

OPTICAL RESULTS (SIMULATED):



LED LUXEON S1000
FWHM / FWTM 3.8° / 8.0°
Efficiency 88 %
Peak intensity 100 cd/lm
LEDs/each optic 1
Light colour/type White
Required components:

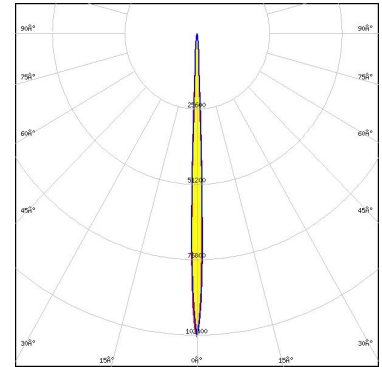

Light distribution files



LED LUXEON V2
FWHM / FWTM 2.0° / 4.0°
Efficiency 88 %
Peak intensity 250.1 cd/lm
LEDs/each optic 1
Light colour/type White
Required components:

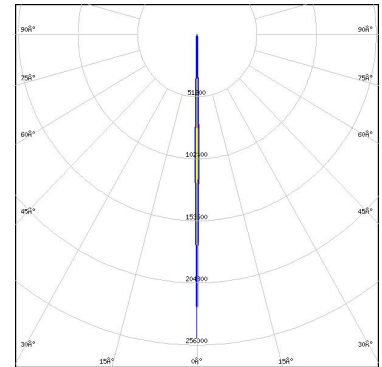

Light distribution files



LED SBT-90
FWHM / FWTM 2.0° / 6.0°
Efficiency 76 %
Peak intensity 175.9 cd/lm
LEDs/each optic 1
Light colour/type White
Required components:

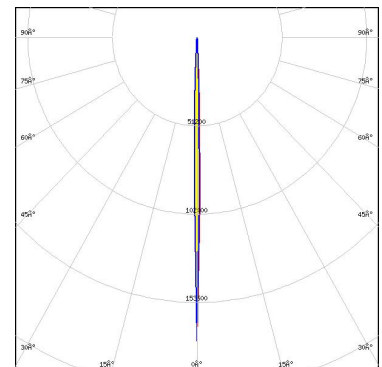

Light distribution files

OPTICAL RESULTS (SIMULATED):



LED NV4WB35AM
FWHM / FWTM 2.0° / 4.0°
Efficiency 90 %
Peak intensity 185.5 cd/lm
LEDs/each optic 1
Light colour/type White
Required components:

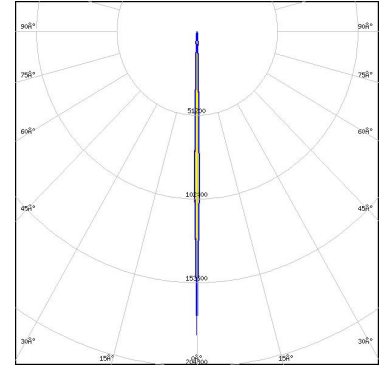

Light distribution files



LED NVSW219F
FWHM / FWTM 2.0° / 4.0°
Efficiency 89 %
Peak intensity 296 cd/lm
LEDs/each optic 1
Light colour/type White
Required components:

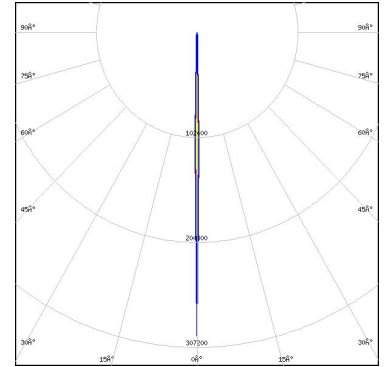

Light distribution files



LED NVSW519A
FWHM / FWTM 2.0° / 4.0°
Efficiency 89 %
Peak intensity 251.6 cd/lm
LEDs/each optic 1
Light colour/type White
Required components:

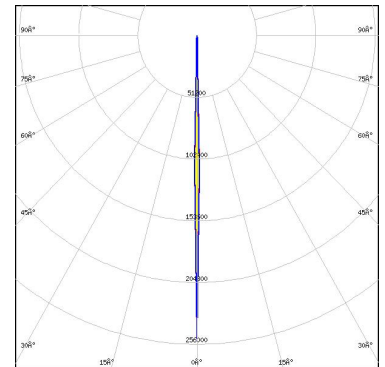

Light distribution files

OPTICAL RESULTS (SIMULATED):

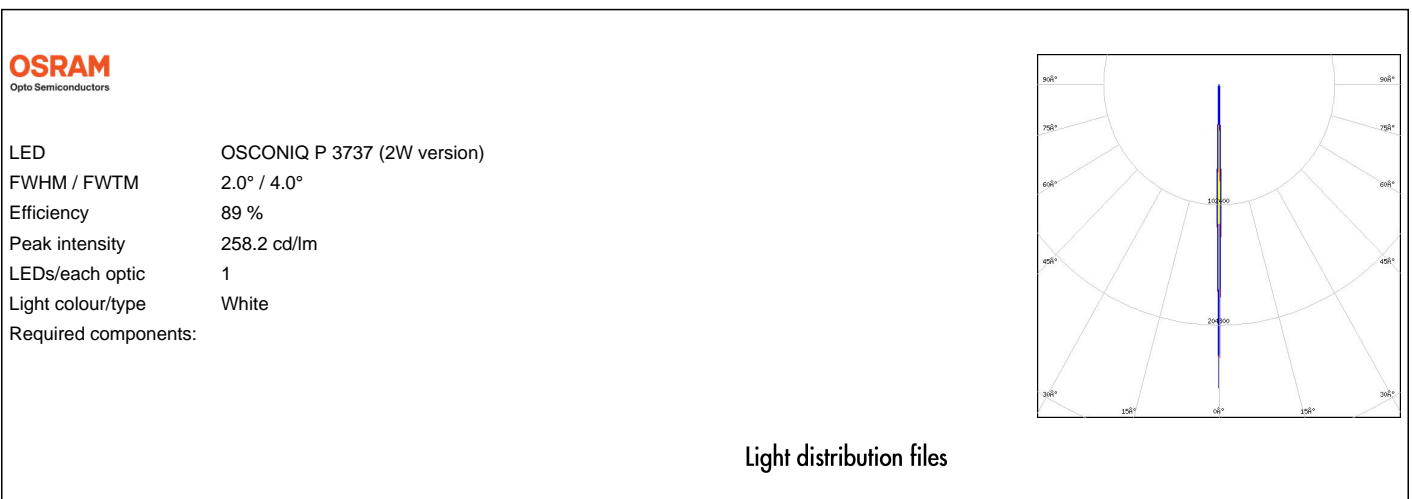
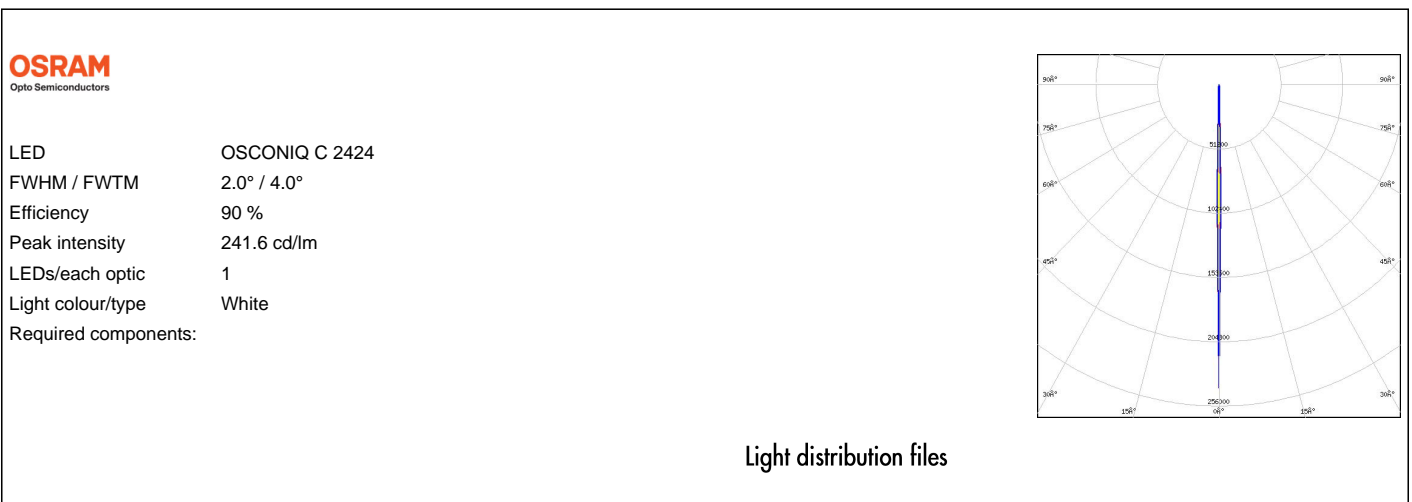
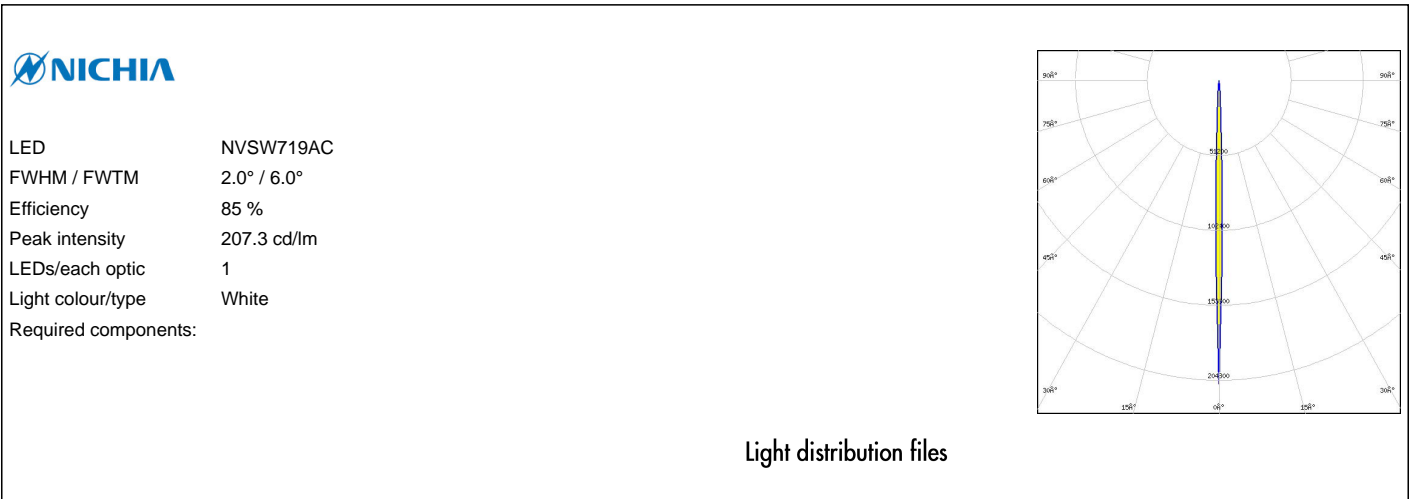

OPTICAL RESULTS (SIMULATED):

OSRAM
Opto Semiconductors

LED OSCONIQ P 3737 (3W version)
FWHM / FWTM 2.0° / 4.0°
Efficiency 90 %
Peak intensity 232.3 cd/lm
LEDs/each optic 1
Light colour/type White
Required components:

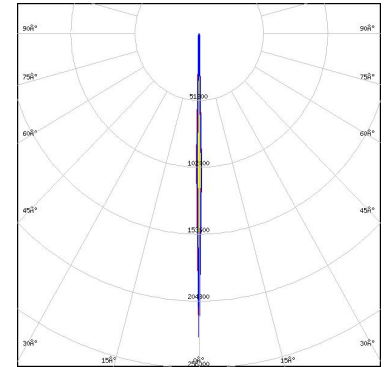

Light distribution files

OSRAM
Opto Semiconductors

LED OSCONIQ P 7070
FWHM / FWTM 3.5° / 7.1°
Efficiency 91 %
Peak intensity 122.2 cd/lm
LEDs/each optic 1
Light colour/type White
Required components:

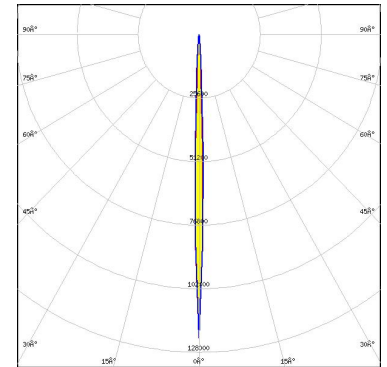

Light distribution files

OSRAM
Opto Semiconductors

LED OSLO Boost HX (KW CULPM1.TG)
FWHM / FWTM 2.0° / 6.0°
Efficiency 92 %
Peak intensity 176.8 cd/lm
LEDs/each optic 1
Light colour/type White
Required components:

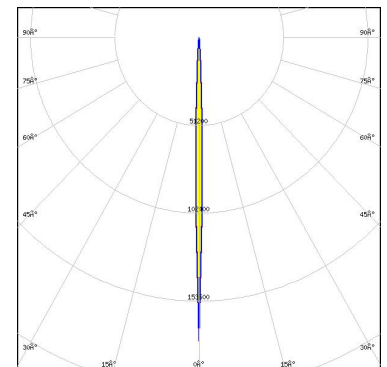

Light distribution files

OPTICAL RESULTS (SIMULATED):

OSRAM
Opto Semiconductors

LED OSLON Square PC
FWHM / FWTM 1.5° / 3.6°
Efficiency 89 %
Peak intensity 550 cd/lm
LEDs/each optic 1
Light colour/type White
Required components:

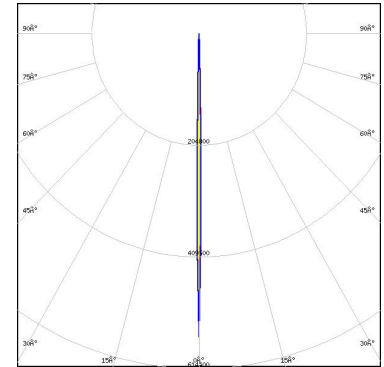

Light distribution files

OSRAM
Opto Semiconductors

LED OSRAM OSTAR Projection Compact (KW CSLPM1.TG)
FWHM / FWTM 2.0° / 4.0°
Efficiency 90 %
Peak intensity 229.3 cd/lm
LEDs/each optic 1
Light colour/type White
Required components:

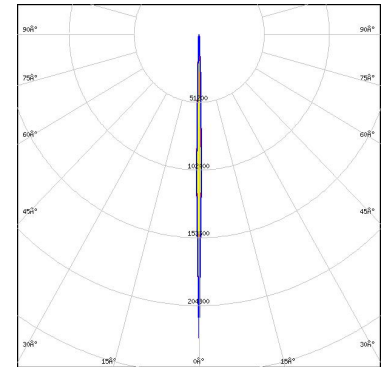

Light distribution files

SAMSUNG

LED LH351B
FWHM / FWTM 2.0° / 4.0°
Efficiency 90 %
Peak intensity 279.4 cd/lm
LEDs/each optic 1
Light colour/type White
Required components:

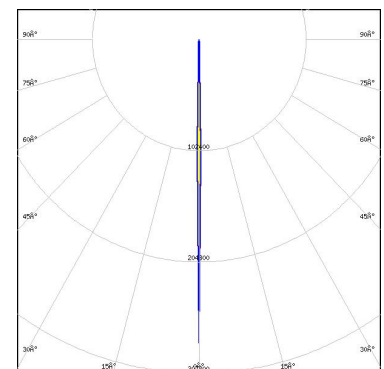

Light distribution files

OPTICAL RESULTS (SIMULATED):

SAMSUNG

LED LH351C
FWHM / FWTM 2.0° / 4.0°
Efficiency 91 %
Peak intensity 279.2 cd/lm
LEDs/each optic 1
Light colour/type White
Required components:

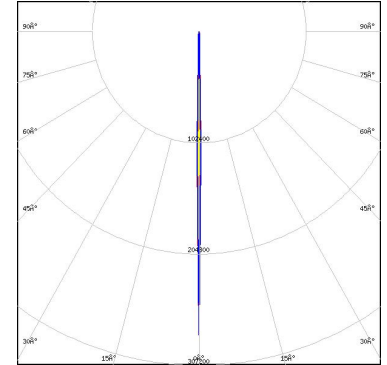

Light distribution files

SAMSUNG

LED LH351D
FWHM / FWTM 2.0° / 4.0°
Efficiency 91 %
Peak intensity 235.3 cd/lm
LEDs/each optic 1
Light colour/type White
Required components:

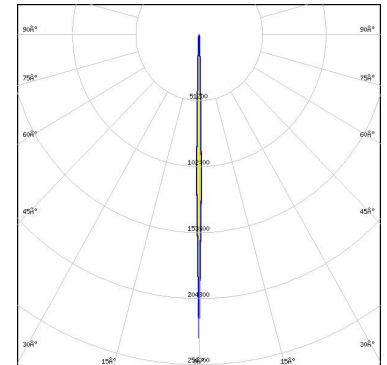

Light distribution files



LED Z5M3
FWHM / FWTM 1.4° / 3.3°
Efficiency 94 %
Peak intensity 151.4 cd/lm
LEDs/each optic 1
Light colour/type White
Required components:

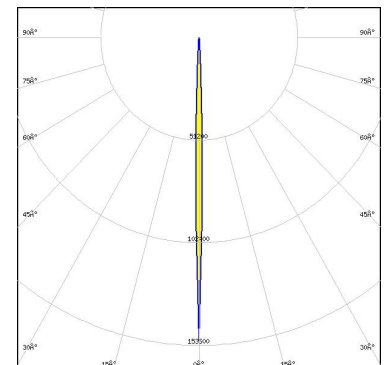

Light distribution files

OPTICAL RESULTS (SIMULATED):

 SEOUL SEMICONDUCTOR	
LED	Z5M4
FWHM / FWTM	1.7° / 3.5°
Efficiency	96 %
Peak intensity	149.4 cd/lm
LEDs/each optic	1
Light colour/type	White
Required components:	

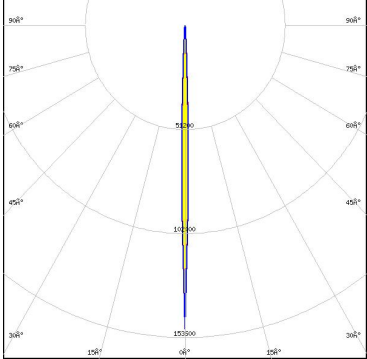

Light distribution files

 SEOUL SEMICONDUCTOR	
LED	Z8Y50P
FWHM / FWTM	3.0° / 7.0°
Efficiency	79 %
Peak intensity	90.4 cd/lm
LEDs/each optic	1
Light colour/type	White
Required components:	

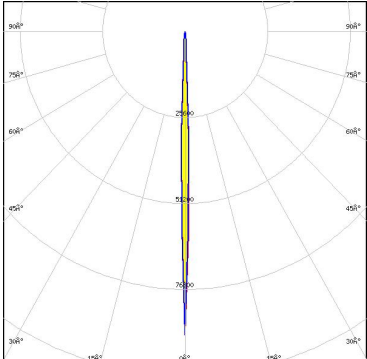

Light distribution files

GENERAL INFORMATION:

NOTE: The typical beam angle will be changed by different color, chip size and chip position tolerance. The typical total beam angle is the full angle measured where the luminous intensity is half of the peak value.

MATERIALS:

As part of our continuous research and improvement processes, and to ensure the best possible quality and availability of our products, LEDiL reserves the right to change material grades without notice.

PRODUCT DATA USER AGREEMENT AND DISCLAIMER:

The measured data in the provided downloadable LEDiL Product Datasheets and Mechanical 2D-Drawings is rounded and provided as reference for planning. LEDiL Oy's optical specifications have been verified by conducting performance testing of the products in accordance with the company's quality system. The reported data are averaged results of multiple measurements with typical variation. LEDiL Oy reserves the right to without prior notification make changes and improvements to its products.

LEDiL Oy assumes neither warranty, nor guarantee nor any other liability of any kind for the contents and correctness of the provided data. The provided data has been generated with highest diligence but the provided data may in reality not represent the complete possible variation range of all intrinsic parameters. Therefore, in certain cases a deviation from the provided data could occur.

LEDiL Oy reserves the right to undertake technical changes of its products without further notification which could lead to changes in the provided data. LEDiL Oy assumes no liability of any kind for the possible deviation from any provided data or any other damage resulting from the usage of the provided data.

The user agrees to this disclaimer and user agreement with the download or usage of the provided files.

LEDiL Oy

Joensuunkatu 13
FI-24240 SALO
Finland

LEDiL Inc.

228 West Page Street
Suite D
Sycamore IL 60178
USA

Ledil Optics Technology (Shenzhen) Co., Ltd.

405 , Block B
Casic Motor Building
Shenzhen 518057
P.R.CHINA

Local sales and technical support

[www.ledil.com/
where_to_buy](http://www.ledil.com/where_to_buy)

Shipping locations

Poznan, Poland
Hong Kong, China

Distribution Partners

[www.ledil.com/
where_to_buy](http://www.ledil.com/where_to_buy)