

STELLA-A

Type II and III beam for street lighting.
Compatible with up to 23 mm LES size COBs.
Variant with white frame.

SPECIFICATION:

Dimensions	Ø 90.0 mm
Height	22 mm
Fastening	screw
Ingress protection classes	IP67
ROHS compliant	yes ⓘ



MATERIALS:

Component	Type	Material	Colour	Finish	Length
STELLA-A	Single lens	Silicone	clear		85.0
STELLA-FRAME-WHT	Holder	PA66	white		90.0

ORDERING INFORMATION:

Component		Qty in box	MOQ	MPQ	Box weight (kg)
FN14253_STELLA-A	Single lens	100		10	0.0
» Box size: 480 x 280 x 300 mm					

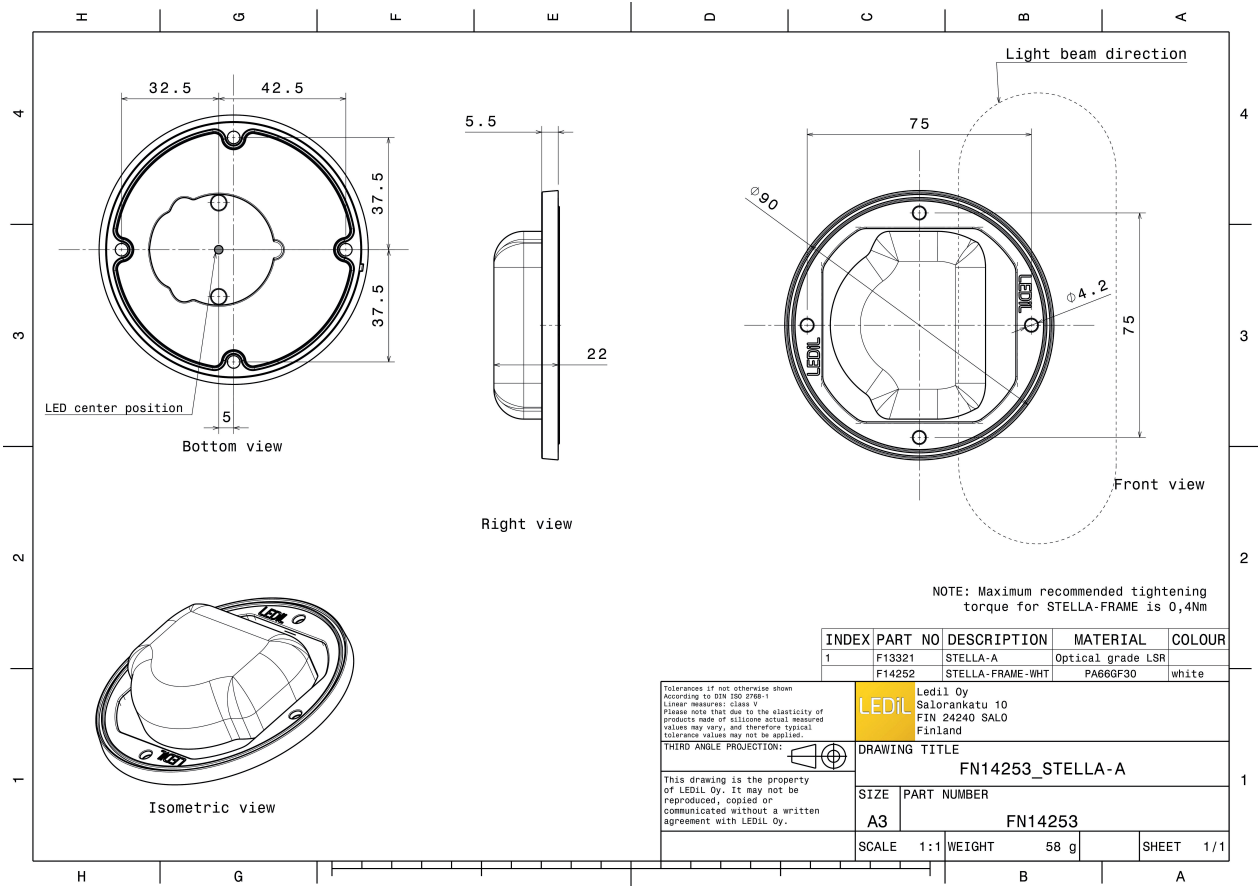

See also our general installation guide: www.ledil.com/installation_guide

OPTICAL RESULTS (MEASURED):

bridgelux.

LED V18 Gen7
FWHM / FWTM Asymmetric
Efficiency 81 %
Peak intensity 0.3 cd/lm
LEDs/each optic 1
Light colour/type White
Required components:

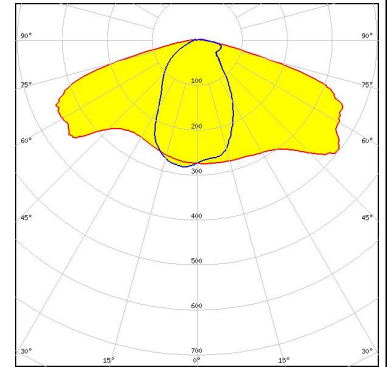

Light distribution files

bridgelux.

LED VERO13
FWHM / FWTM Asymmetric
Efficiency 92 %
Peak intensity 0.7 cd/lm
LEDs/each optic 1
Light colour/type White
Required components:

Light distribution files

bridgelux.

LED VERO18
FWHM / FWTM Asymmetric
Efficiency 92 %
Peak intensity 0.5 cd/lm
LEDs/each optic 1
Light colour/type White
Required components:

Light distribution files

OPTICAL RESULTS (MEASURED):

CITIZEN

LED CLL03x/CLU03x
FWHM / FWTM Asymmetric
Efficiency 92 %
Peak intensity 0.6 cd/lm
LEDs/each optic 1
Light colour/type White
Required components:

CITIZEN

LED CLL03x/CLU03x
FWHM / FWTM Asymmetric
Efficiency 92 %
Peak intensity 0.6 cd/lm
LEDs/each optic 1
Light colour/type White
Required components:
Bender Wirth: 433 Typ L1

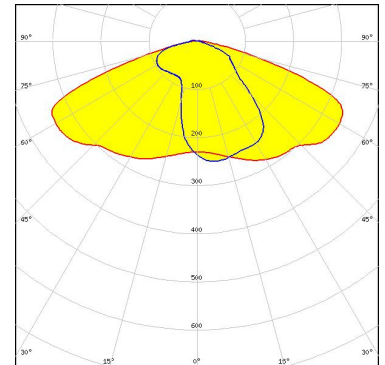

Light distribution files

CITIZEN

LED CLU720/721/723
FWHM / FWTM Asymmetric
Efficiency 93 %
Peak intensity 0.8 cd/lm
LEDs/each optic 1
Light colour/type White
Required components:
Bender Wirth: 433 Typ L1

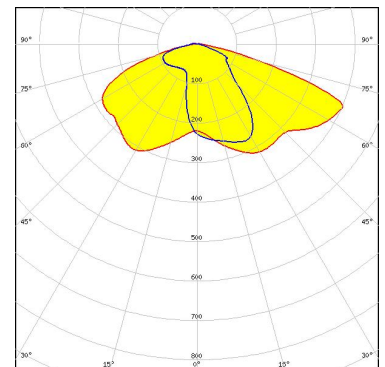

Light distribution files

OPTICAL RESULTS (MEASURED):



LED CXA/B 15xx
FWHM / FWTM Asymmetric
Efficiency 92 %
Peak intensity 1.1 cd/lm
LEDs/each optic 1
Light colour/type White
Required components:



LED CXA/B 15xx
FWHM / FWTM Asymmetric
Efficiency 89 %
Peak intensity 1 cd/lm
LEDs/each optic 1
Light colour/type White
Required components:
C14305_STELLA-CLAMP-CXA15-18

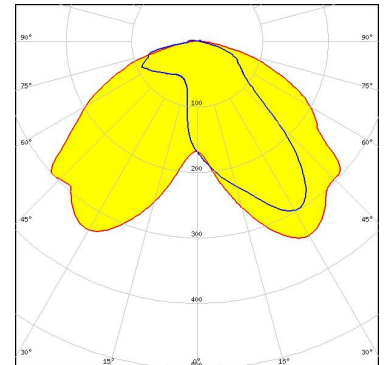

Light distribution files



LED CXA/B 15xx
FWHM / FWTM Asymmetric
Efficiency 92 %
Peak intensity 0.9 cd/lm
LEDs/each optic 1
Light colour/type White
Required components:
Bender Wirth: 441 Typ L1

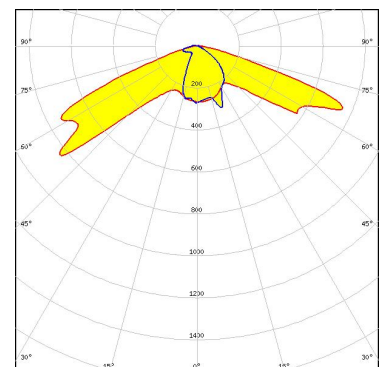

Light distribution files

OPTICAL RESULTS (MEASURED):



LED CXA/B 1816 & CXA/B 1820 & CXA 1850
 FWHM / FWTM Asymmetric
 Efficiency 91 %
 Peak intensity 0.7 cd/lm
 LEDs/each optic 1
 Light colour/type White
 Required components:
 Bender Wirth: 437 Typ L1

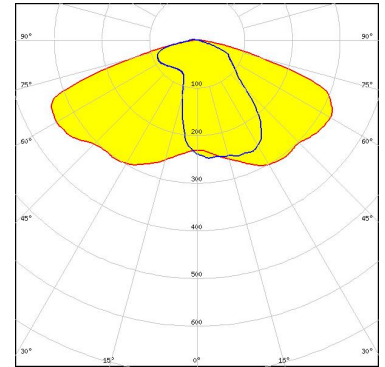

Light distribution files



LED CXA/B 1816 & CXA/B 1820 & CXA 1850
 FWHM / FWTM Asymmetric
 Efficiency 88 %
 Peak intensity 0.6 cd/lm
 LEDs/each optic 1
 Light colour/type White
 Required components:

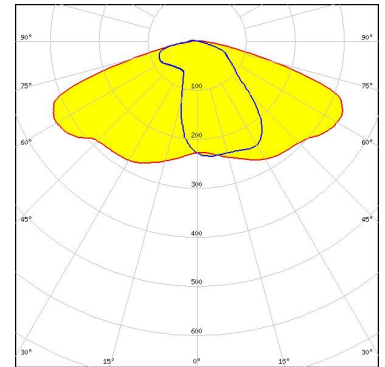

Light distribution files



LED CXA/B 1816 & CXA/B 1820 & CXA 1850
 FWHM / FWTM Asymmetric
 Efficiency 92 %
 Peak intensity 0.7 cd/lm
 LEDs/each optic 1
 Light colour/type White
 Required components:
 C14305_STELLA-CLAMP-CXA15-18

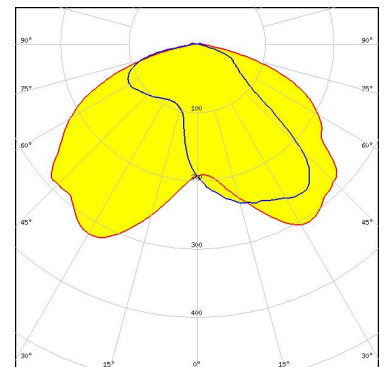

Light distribution files

OPTICAL RESULTS (MEASURED):



LED CXA/B 25xx
FWHM / FWTM Asymmetric
Efficiency 93 %
Peak intensity 0.5 cd/lm
LEDs/each optic 1
Light colour/type White
Required components:



LED LUXEON CoB 1202/1203
FWHM / FWTM Asymmetric
Efficiency 91 %
Peak intensity 0.9 cd/lm
LEDs/each optic 1
Light colour/type White
Required components:
Bender Wirth: 438 Typ L1

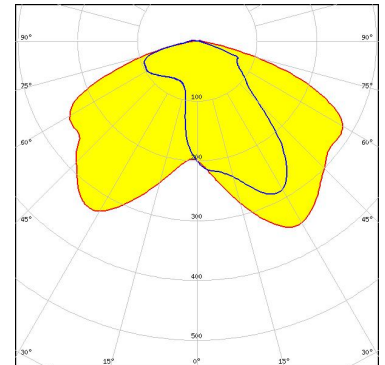

Light distribution files



LED LUXEON CoB 1208
FWHM / FWTM Asymmetric
Efficiency %
Peak intensity 0.3 cd/lm
LEDs/each optic 1
Light colour/type White
Required components:

Light distribution files

OPTICAL RESULTS (MEASURED):

NICHIA

LED	COB J-Type
FWHM / FWTM	Asymmetric
Efficiency	88 %
Peak intensity	0.5 cd/lm
LEDs/each optic	1
Light colour/type	White
Required components:	

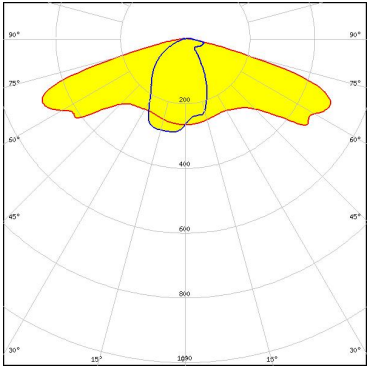

Light distribution files

NICHIA

LED	COB L-Type (LES 11)
FWHM / FWTM	Asymmetric
Efficiency	91 %
Peak intensity	0.7 cd/lm
LEDs/each optic	1
Light colour/type	White
Required components:	Bender Wirth: 438 Typ L1

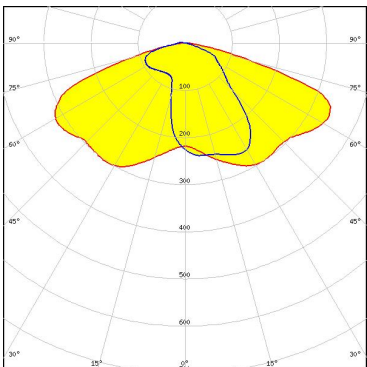

Light distribution files

NICHIA

LED	COB L-Type (LES 9)
FWHM / FWTM	Asymmetric
Efficiency	92 %
Peak intensity	1 cd/lm
LEDs/each optic	1
Light colour/type	White
Required components:	Bender Wirth: 438 Typ L1

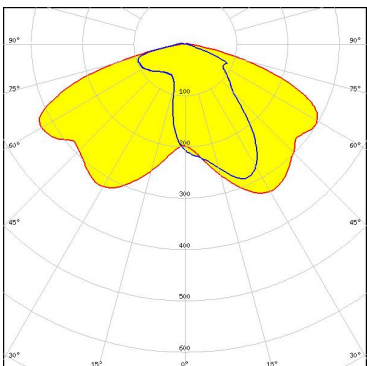

Light distribution files

OPTICAL RESULTS (MEASURED):

OSRAM
Opto Semiconductors

LED Soleriq S13
FWHM / FWTM Asymmetric
Efficiency 87 %
Peak intensity 0.7 cd/lm
LEDs/each optic 1
Light colour/type White
Required components:

Light distribution files

OSRAM
Opto Semiconductors

LED Soleriq S13
FWHM / FWTM Asymmetric
Efficiency 93 %
Peak intensity 0.7 cd/lm
LEDs/each optic 1
Light colour/type White
Required components:
Bender Wirth: 437 Typ L1

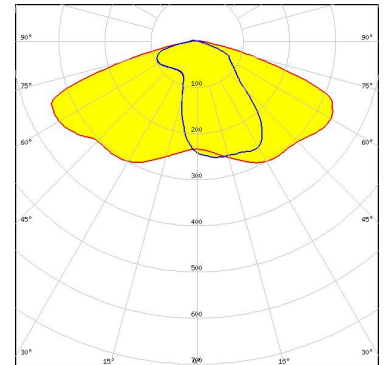

Light distribution files

OSRAM
Opto Semiconductors

LED Soleriq S19
FWHM / FWTM Asymmetric
Efficiency %
LEDs/each optic 1
Light colour/type White
Required components:

Light distribution files

OPTICAL RESULTS (MEASURED):

SAMSUNG

LED LC016D / LC019D / LC026D / LC033D
FWHM / FWTM Asymmetric
Efficiency 88 %
Peak intensity 0.5 cd/m
LEDs/each optic 1
Light colour/type White
Required components:

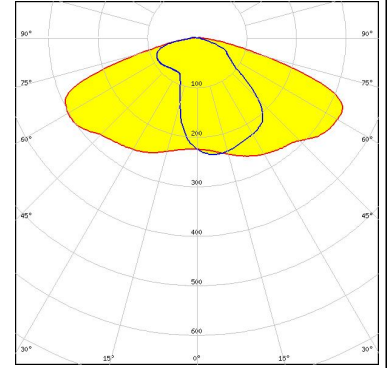

Light distribution files

OPTICAL RESULTS (SIMULATED):

bridgelux.

LED V10 Gen7
FWHM / FWTM Asymmetric
Efficiency 89 %
Peak intensity 0.6 cd/lm
LEDs/each optic 1
Light colour/type White
Required components:

Bender Wirth: 486 Typ L1

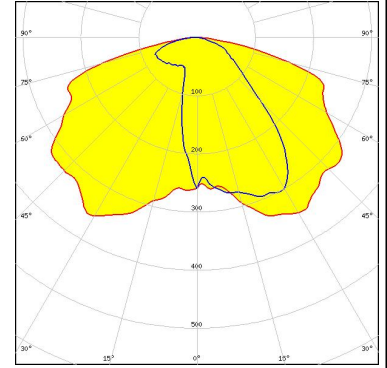

Light distribution files

bridgelux.

LED V13 Gen7
FWHM / FWTM Asymmetric
Efficiency 89 %
Peak intensity 0.6 cd/lm
LEDs/each optic 1
Light colour/type White
Required components:

Bender Wirth: 477 Typ L1

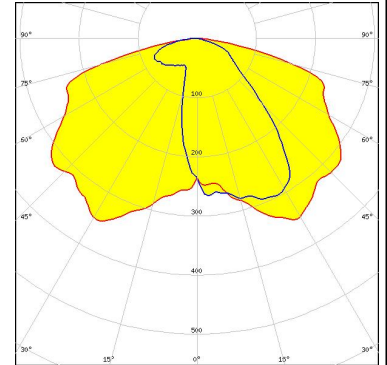

Light distribution files

GENERAL INFORMATION:

NOTE: The typical beam angle will be changed by different color, chip size and chip position tolerance. The typical total beam angle is the full angle measured where the luminous intensity is half of the peak value.

Due to use of high power COB's with this product, special attention to proper thermal design is highly recommended. LEDiL has no liability for direct, indirect or consecutive damages arising from the LEDiL products being used outside of the recommended temperature range.

MATERIALS:

As part of our continuous research and improvement processes, and to ensure the best possible quality and availability of our products, LEDiL reserves the right to change material grades without notice.

PRODUCT DATA USER AGREEMENT AND DISCLAIMER:

The measured data in the provided downloadable LEDiL Product Datasheets and Mechanical 2D-Drawings is rounded and provided as reference for planning. LEDiL Oy's optical specifications have been verified by conducting performance testing of the products in accordance with the company's quality system. The reported data are averaged results of multiple measurements with typical variation. LEDiL Oy reserves the right to without prior notification make changes and improvements to its products.

LEDiL Oy assumes neither warranty, nor guarantee nor any other liability of any kind for the contents and correctness of the provided data. The provided data has been generated with highest diligence but the provided data may in reality not represent the complete possible variation range of all intrinsic parameters. Therefore, in certain cases a deviation from the provided data could occur.

LEDiL Oy reserves the right to undertake technical changes of its products without further notification which could lead to changes in the provided data. LEDiL Oy assumes no liability of any kind for the possible deviation from any provided data or any other damage resulting from the usage of the provided data.

The user agrees to this disclaimer and user agreement with the download or usage of the provided files.

LEDiL Oy

Joensuunkatu 13
FI-24240 SALO
Finland

LEDiL Inc.

228 West Page Street
Suite D
Sycamore IL 60178
USA

Ledil Optics Technology (Shenzhen) Co., Ltd.

405 , Block B
Casic Motor Building
Shenzhen 518057
P.R.CHINA

Local sales and technical support

[www.ledil.com/
where_to_buy](http://www.ledil.com/where_to_buy)

Shipping locations

Poznan, Poland
Hong Kong, China

Distribution Partners

[www.ledil.com/
where_to_buy](http://www.ledil.com/where_to_buy)