

SURI-RS

~6° real spot beam with holder

SPECIFICATION:

Dimensions	Ø 37.8
Height	23.9 mm
Fastening	pin, screw
ROHS compliant	yes ⓘ

MATERIALS:

Component	Type	Material	Colour	Finish	Length (mm)
C16197_SURI-RS	Single lens	PMMA	clear		
C16192_GABRIELLA-MIDI-HLD	Holder	PC	black		

ORDERING INFORMATION:

Quantities for one set:

Single lens	1
Holder	1



Component		Qty in box	MOQ	MPQ	Box weight (kg)
C16197_SURI-RS	Single lens	500	100	50	7.4
» Box size: 476 x 273 x 292 mm					
C16192_GABRIELLA-MIDI-HLD	Holder	500	100	50	3.6
» Box size: 476 x 273 x 292 mm					

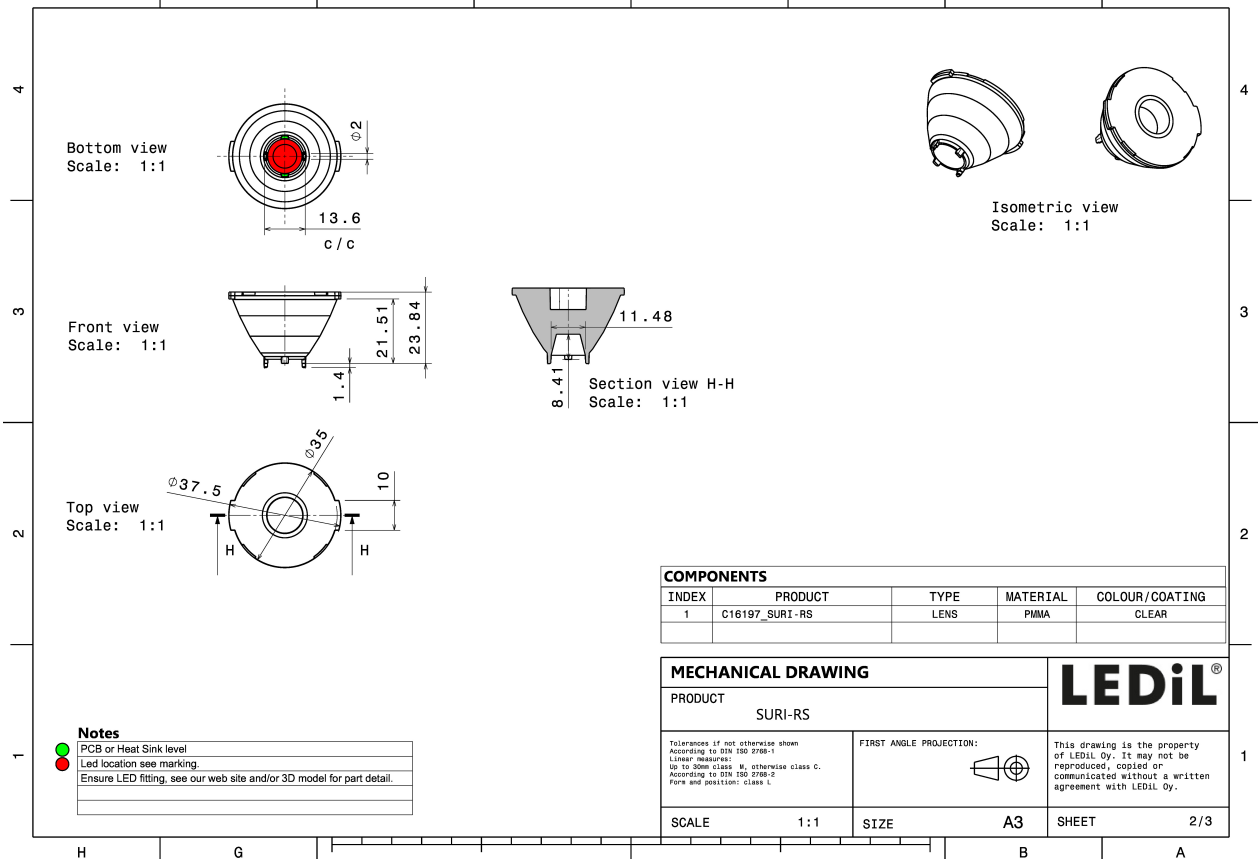
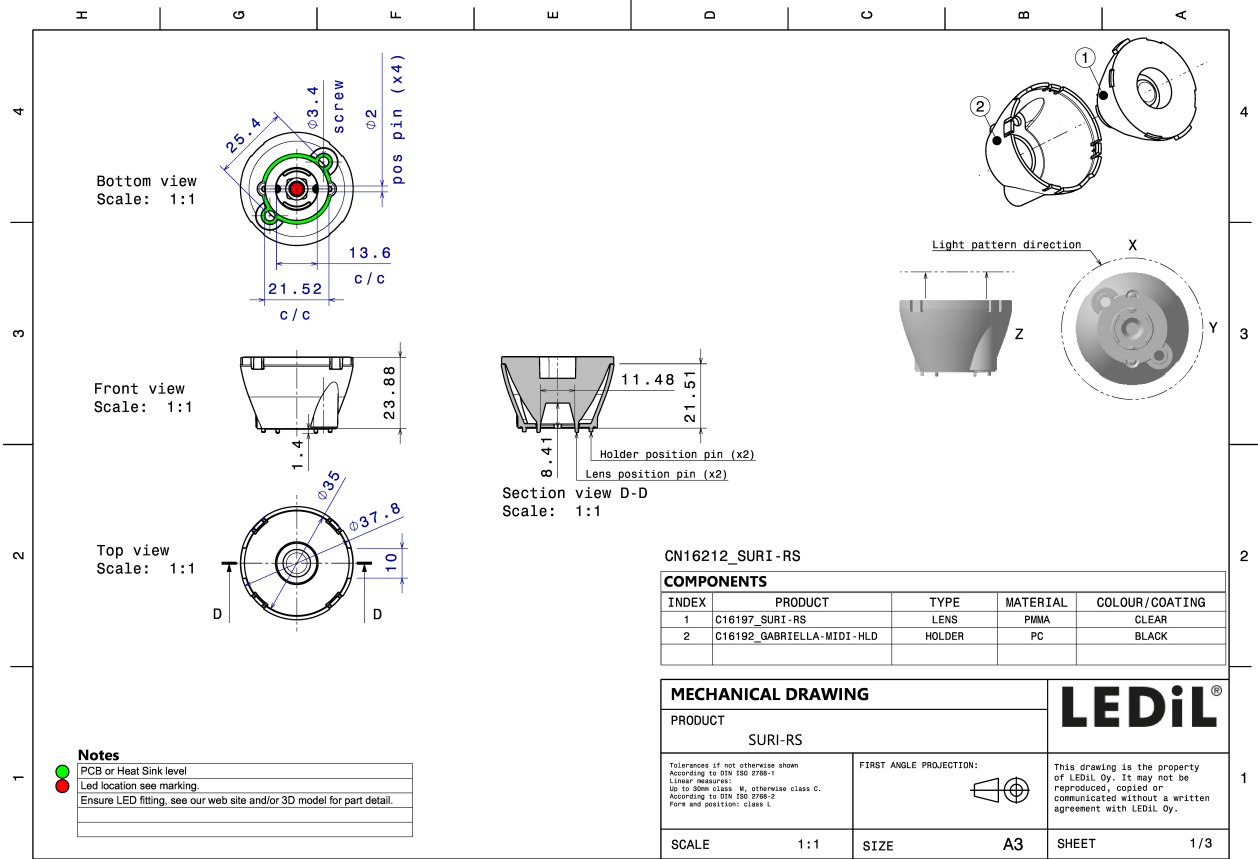

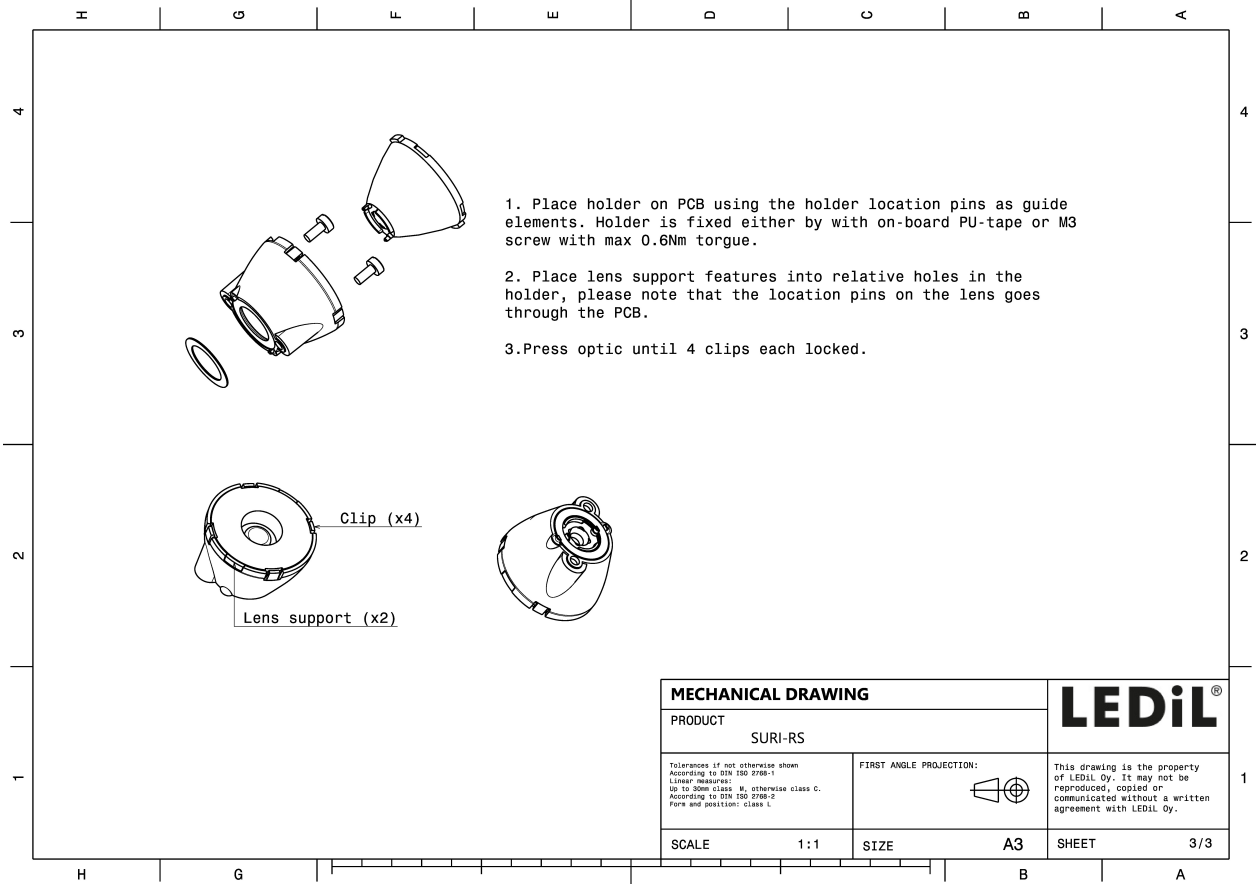

See also our general installation guide: www.ledil.com/installation_guide

OPTICAL RESULTS (MEASURED):



LED XHP70.2
FWHM / FWTM 20.0° / 32.0°
Efficiency 88 %
Peak intensity 6.6 cd/lm
LEDs/each optic 1
Light colour/type White
Required components:

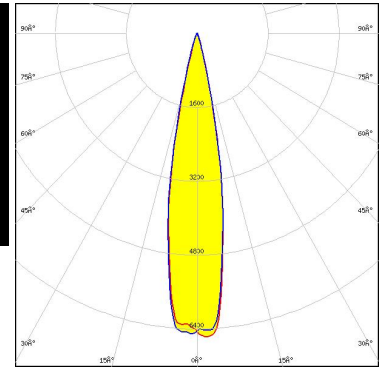
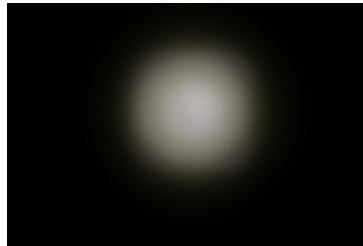

Light distribution files



LED XQ-E HI
FWHM / FWTM 4.0° / 8.0°
Efficiency 91 %
Peak intensity 129.5 cd/lm
LEDs/each optic 1
Light colour/type White
Required components:

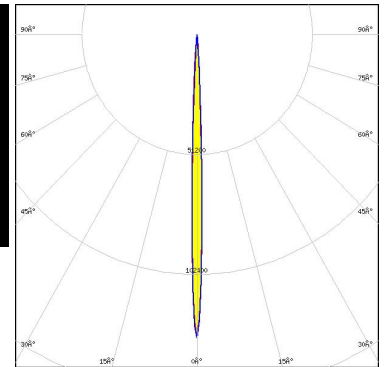

Light distribution files



LED XT-E
FWHM / FWTM 7.0° / 12.0°
Efficiency 86 %
Peak intensity 47.5 cd/lm
LEDs/each optic 1
Light colour/type White
Required components:

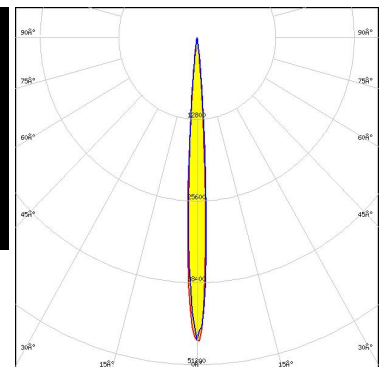
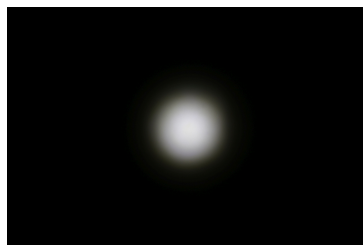

Light distribution files

OPTICAL RESULTS (MEASURED):



LED LUXEON C
FWHM / FWTM 5.0° / 9.0°
Efficiency 86 %
Peak intensity 91.5 cd/lm
LEDs/each optic 1
Light colour/type White
Required components:

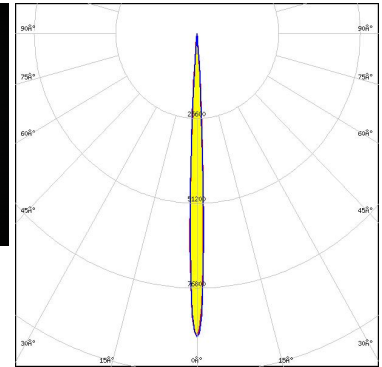

Light distribution files



LED LUXEON CZ
FWHM / FWTM 4.0° / 9.0°
Efficiency 93 %
Peak intensity 124 cd/lm
LEDs/each optic 1
Light colour/type White
Required components:

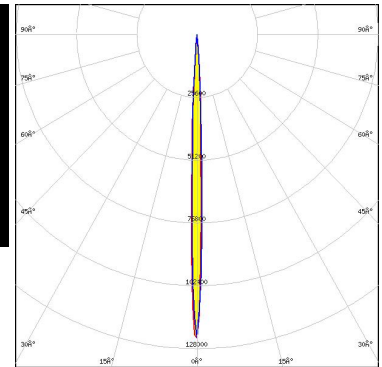

Light distribution files



LED LUXEON Z
FWHM / FWTM 4.0° / 7.0°
Efficiency 92 %
Peak intensity 158 cd/lm
LEDs/each optic 1
Light colour/type White
Required components:

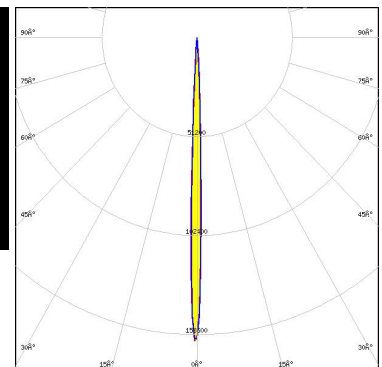

Light distribution files

OPTICAL RESULTS (MEASURED):



LED NVSW219F
 FWHM / FWTM 7.0° / 13.0°
 Efficiency 92 %
 Peak intensity 46 cd/lm
 LEDs/each optic 1
 Light colour/type White
 Required components:

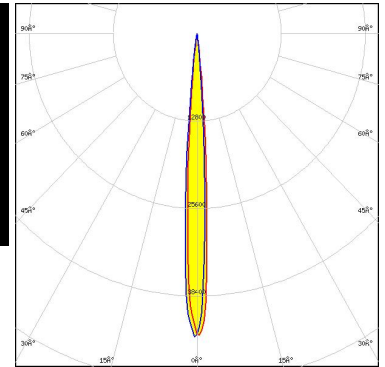
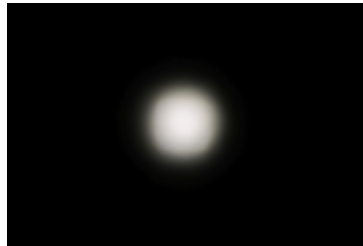

Light distribution files



LED Duris S8
 FWHM / FWTM 14.0° / 24.0°
 Efficiency 90 %
 Peak intensity 13.5 cd/lm
 LEDs/each optic 1
 Light colour/type White
 Required components:

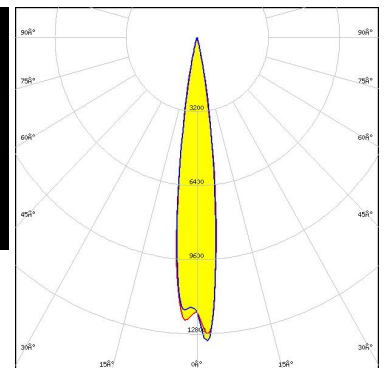
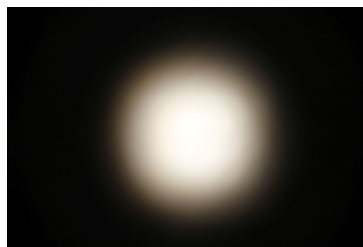

Light distribution files



LED OSCONIQ P 3737 (2W version)
 FWHM / FWTM 7.0° / 13.0°
 Efficiency 90 %
 Peak intensity 47.7 cd/lm
 LEDs/each optic 1
 Light colour/type White
 Required components:

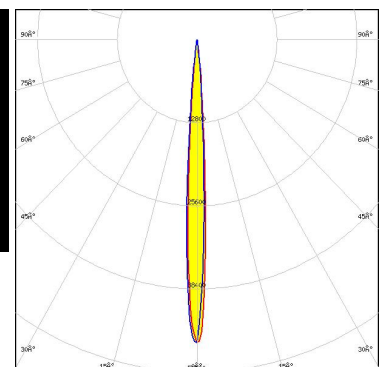

Light distribution files

OPTICAL RESULTS (MEASURED):

OSRAM
Opto Semiconductors

LED OSLON Boost HX (KW CULPM1.TG)
 FWHM / FWTM 6.0° / 11.0°
 Efficiency 92 %
 Peak intensity 75.2 cd/lm
 LEDs/each optic 1
 Light colour/type White
 Required components:

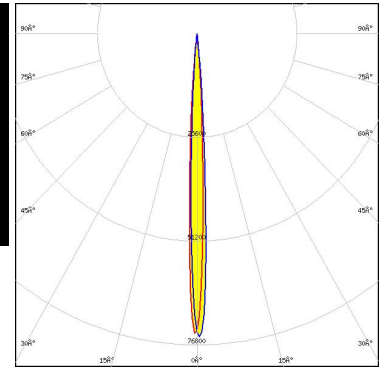

Light distribution files

OSRAM
Opto Semiconductors

LED OSLON Square EC
 FWHM / FWTM 6.0° / 12.0°
 Efficiency 90 %
 Peak intensity 56 cd/lm
 LEDs/each optic 1
 Light colour/type White
 Required components:

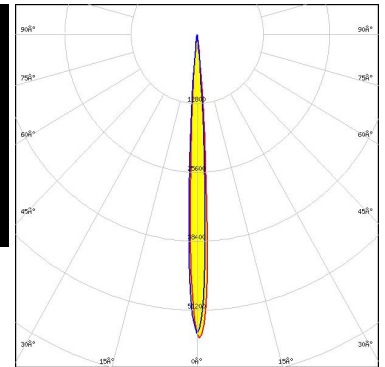

Light distribution files

OSRAM
Opto Semiconductors

LED OSLON SSL 150
 FWHM / FWTM 5.0° / 9.0°
 Efficiency 93 %
 Peak intensity 106 cd/lm
 LEDs/each optic 1
 Light colour/type White
 Required components:

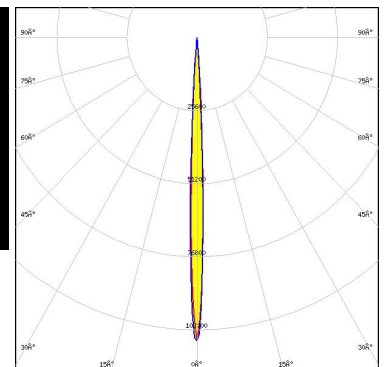

Light distribution files

OPTICAL RESULTS (MEASURED):

SAMSUNG

LED LH181B
 FWHM / FWTM 7.0° / 13.0°
 Efficiency 91 %
 Peak intensity 48.2 cd/lm
 LEDs/each optic 1
 Light colour/type White
 Required components:

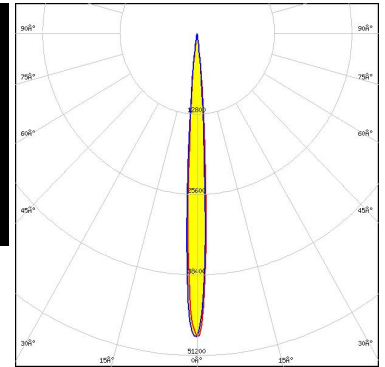
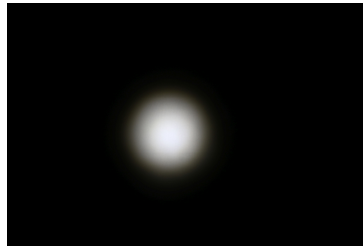

Light distribution files

SAMSUNG

LED LH508A
 FWHM / FWTM 13.0° / 21.0°
 Efficiency 91 %
 Peak intensity 16.9 cd/lm
 LEDs/each optic 1
 Light colour/type White
 Required components:

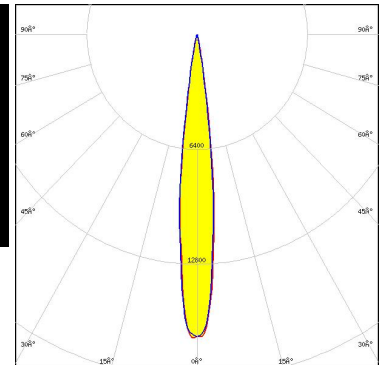
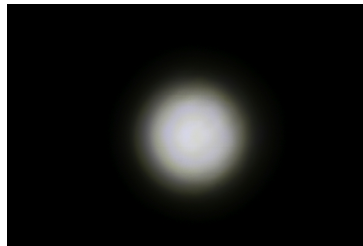

Light distribution files



LED WICOP 5050
 FWHM / FWTM 15.0° / 24.0°
 Efficiency 86 %
 Peak intensity 11.5 cd/lm
 LEDs/each optic 1
 Light colour/type White
 Required components:

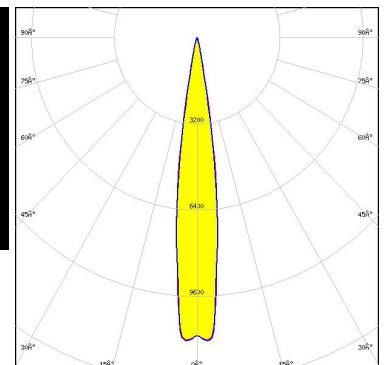

Light distribution files

OPTICAL RESULTS (MEASURED):

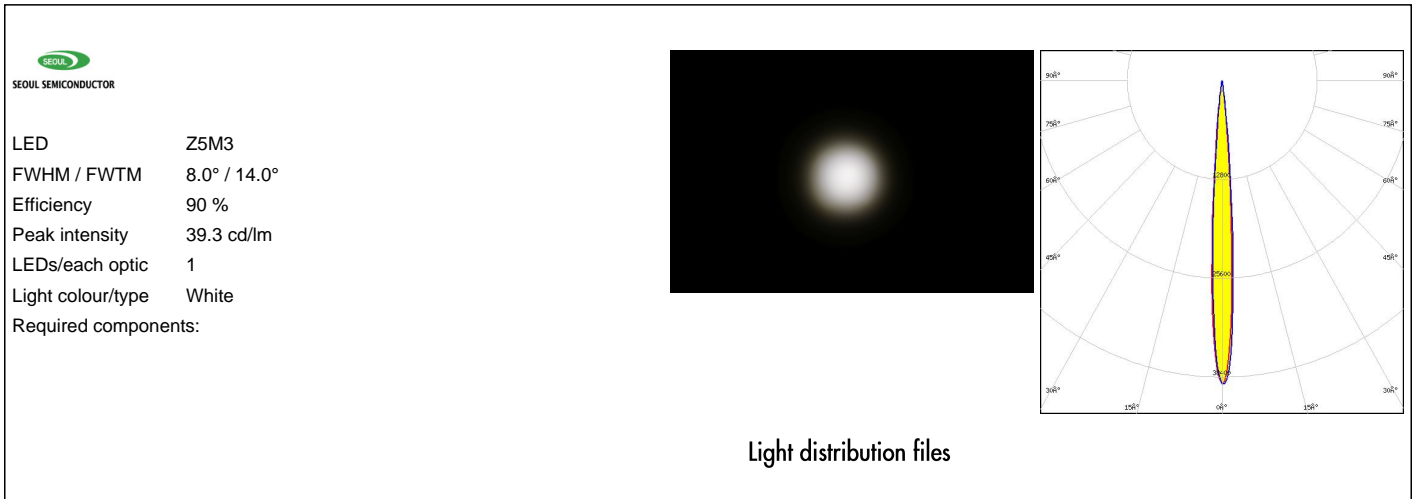

OPTICAL RESULTS (SIMULATED):



LED Bridgelux SMD 5050
 FWHM / FWTM 12.0° / 22.0°
 Efficiency 93 %
 Peak intensity 17.9 cd/lm
 LEDs/each optic 1
 Light colour/type White
 Required components:

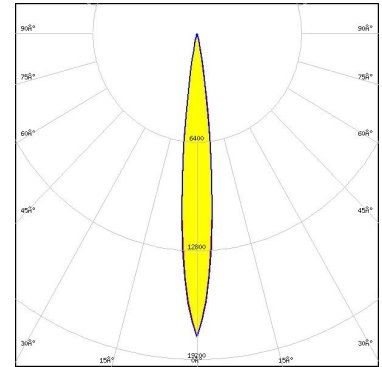

Light distribution files



LED XD16
 FWHM / FWTM 6.0° / 11.0°
 Efficiency 87 %
 Peak intensity 66 cd/lm
 LEDs/each optic 1
 Light colour/type White
 Required components:

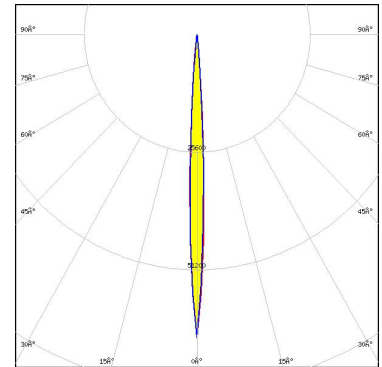

Light distribution files



LED XHP35 HI
 FWHM / FWTM 8.0° / 14.0°
 Efficiency 91 %
 Peak intensity 41.9 cd/lm
 LEDs/each optic 1
 Light colour/type White
 Required components:

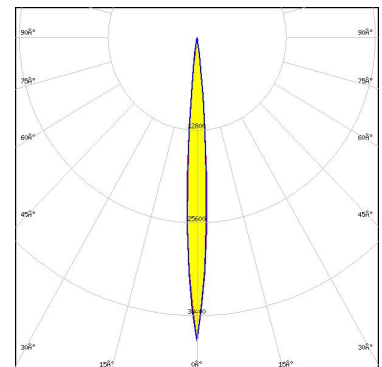

Light distribution files

OPTICAL RESULTS (SIMULATED):



LED XHP35.2 HD
 FWHM / FWTM 12.0° / 22.0°
 Efficiency 89 %
 Peak intensity 16.1 cd/lm
 LEDs/each optic 1
 Light colour/type White
 Required components:

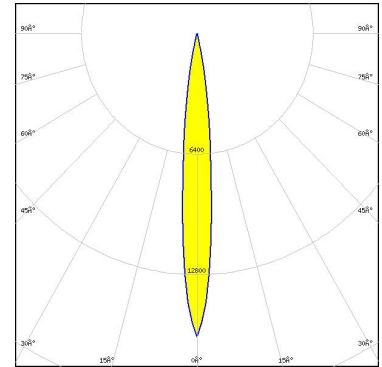

Light distribution files



LED XHP35.2 HI
 FWHM / FWTM 10.0° / 16.0°
 Efficiency 91 %
 Peak intensity 27.4 cd/lm
 LEDs/each optic 1
 Light colour/type White
 Required components:

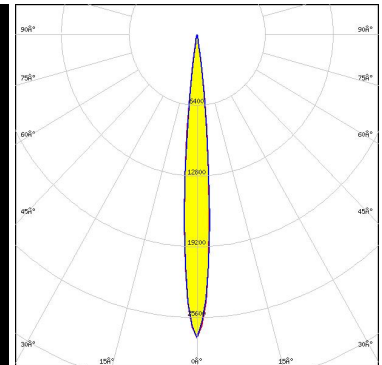
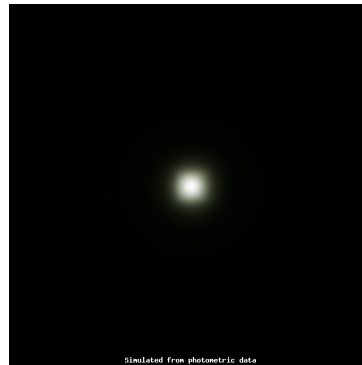

Light distribution files



LED XHP50.2
 FWHM / FWTM 14.0° / 24.0°
 Efficiency 89 %
 Peak intensity 13 cd/lm
 LEDs/each optic 1
 Light colour/type White
 Required components:

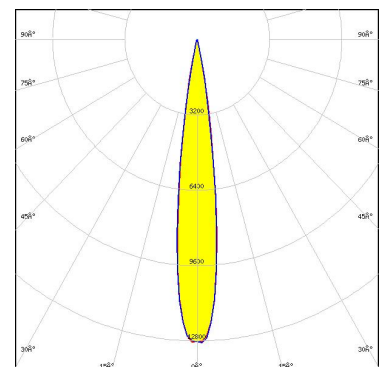

Light distribution files

OPTICAL RESULTS (SIMULATED):



LED XHP50.3 HD
FWHM / FWTM 14.0° / 22.0°
Efficiency 89 %
Peak intensity 14.7 cd/lm
LEDs/each optic 1
Light colour/type White
Required components:

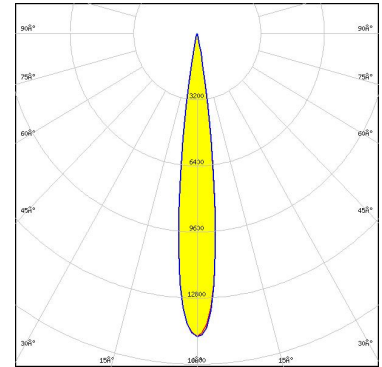

Light distribution files



LED XHP50.3 HI
FWHM / FWTM 10.0° / 18.0°
Efficiency 91 %
Peak intensity 23.8 cd/lm
LEDs/each optic 1
Light colour/type White
Required components:

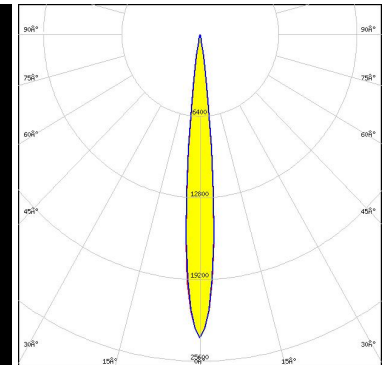

Light distribution files



LED XHP50.3 HI
FWHM / FWTM 10.0° / 18.0°
Efficiency 91 %
Peak intensity 23.9 cd/lm
LEDs/each optic 1
Light colour/type White
Required components:

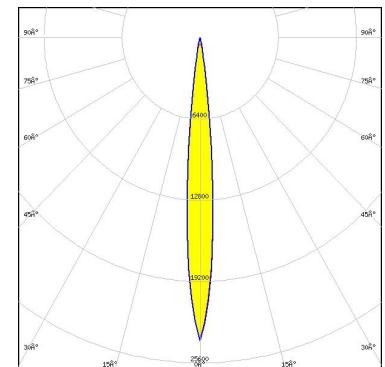

Light distribution files

OPTICAL RESULTS (SIMULATED):



LED XHP70.3 HD
 FWHM / FWTM 18.0° / 30.0°
 Efficiency 88 %
 Peak intensity 7.9 cd/lm
 LEDs/each optic 1
 Light colour/type White
 Required components:

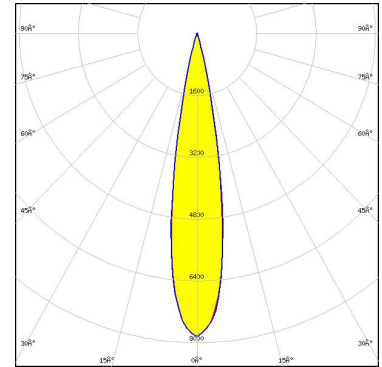

Light distribution files



LED XHP70.3 HI
 FWHM / FWTM 14.0° / 22.0°
 Efficiency 91 %
 Peak intensity 14.5 cd/lm
 LEDs/each optic 1
 Light colour/type White
 Required components:

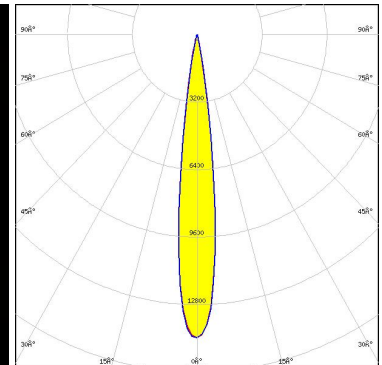

Light distribution files



LED XP-E2
 FWHM / FWTM 5.0° / 10.0°
 Efficiency 91 %
 Peak intensity 85 cd/lm
 LEDs/each optic 1
 Light colour/type White
 Required components:

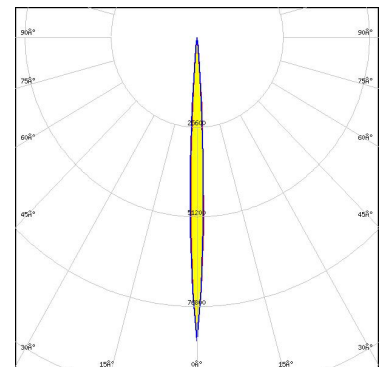

Light distribution files

OPTICAL RESULTS (SIMULATED):



LED XP-G2
 FWHM / FWTM 6.0° / 12.0°
 Efficiency 91 %
 Peak intensity 58 cd/lm
 LEDs/each optic 1
 Light colour/type White
 Required components:

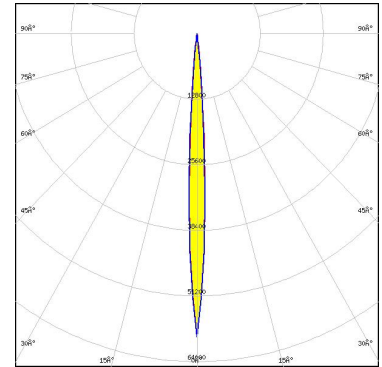

Light distribution files



LED XP-G2 HE
 FWHM / FWTM 8.0° / 16.0°
 Efficiency 91 %
 Peak intensity 38 cd/lm
 LEDs/each optic 1
 Light colour/type White
 Required components:

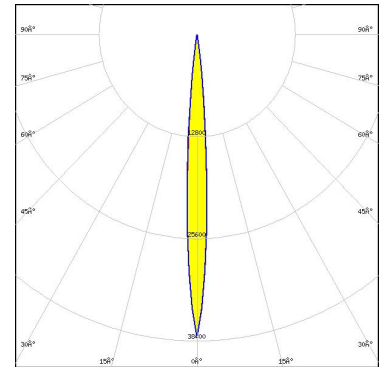

Light distribution files



LED XP-G3
 FWHM / FWTM 7.7° / 14.0°
 Efficiency 90 %
 Peak intensity 40.8 cd/lm
 LEDs/each optic 1
 Light colour/type White
 Required components:

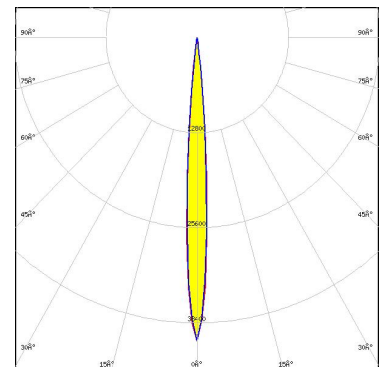

Light distribution files

OPTICAL RESULTS (SIMULATED):



LED XP-G4
 FWHM / FWTM 6.0° / 14.0°
 Efficiency 92 %
 Peak intensity 52.1 cd/lm
 LEDs/each optic 1
 Light colour/type White
 Required components:

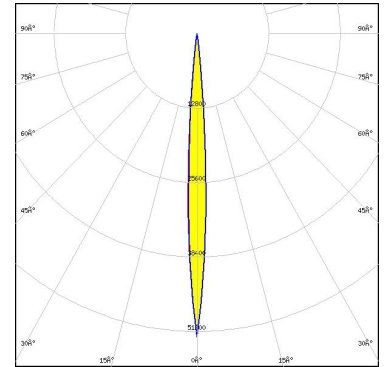

Light distribution files



LED XP-G4 HI
 FWHM / FWTM 6.0° / 12.0°
 Efficiency 90 %
 Peak intensity 67.4 cd/lm
 LEDs/each optic 1
 Light colour/type White
 Required components:

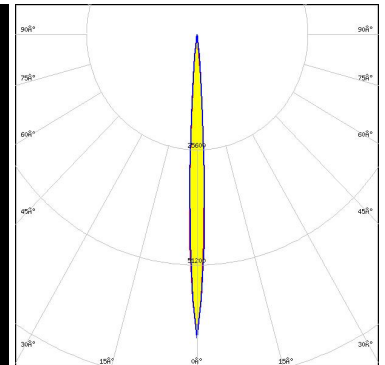
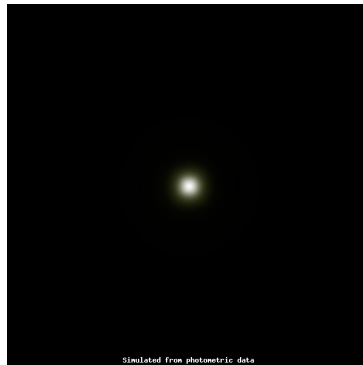

Light distribution files



LED XP-G4 HI
 FWHM / FWTM 6.0° / 12.0°
 Efficiency 90 %
 Peak intensity 61.5 cd/lm
 LEDs/each optic 1
 Light colour/type White
 Required components:

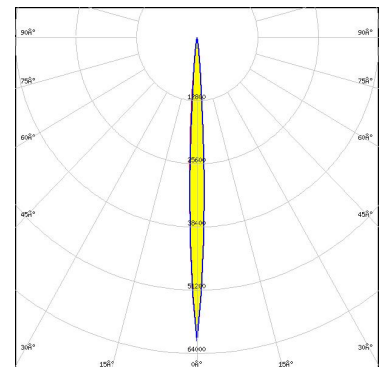

Light distribution files

OPTICAL RESULTS (SIMULATED):



LED XP-L HI
FWHM / FWTM 6.0° / 12.0°
Efficiency 91 %
Peak intensity 56.3 cd/lm
LEDs/each optic 1
Light colour/type White
Required components:

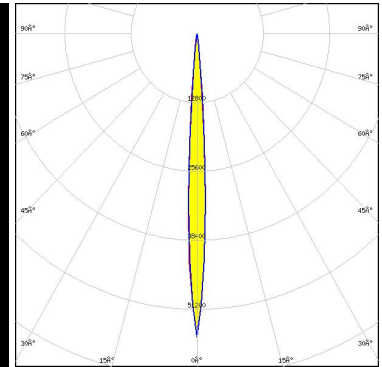

Light distribution files



LED XP-L HI
FWHM / FWTM 6.0° / 12.0°
Efficiency 91 %
Peak intensity 53 cd/lm
LEDs/each optic 1
Light colour/type White
Required components:

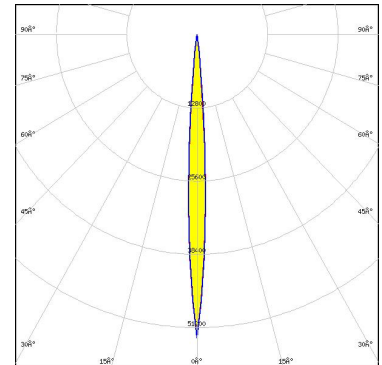

Light distribution files



LED XP-P
FWHM / FWTM 4.0° / 10.0°
Efficiency 94 %
Peak intensity 100 cd/lm
LEDs/each optic 1
Light colour/type White
Required components:

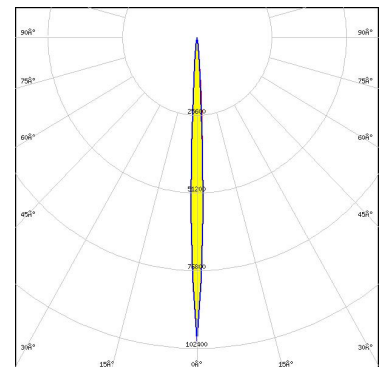

Light distribution files

OPTICAL RESULTS (SIMULATED):



LED XP-P
 FWHM / FWTM 4.0° / 8.0°
 Efficiency 91 %
 Peak intensity 117 cd/lm
 LEDs/each optic 1
 Light colour/type White
 Required components:

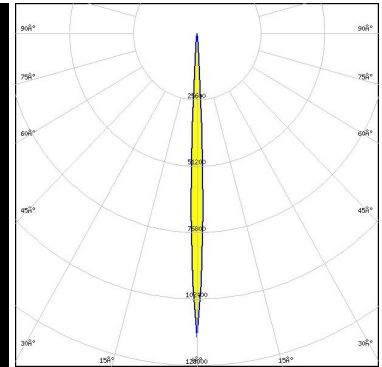
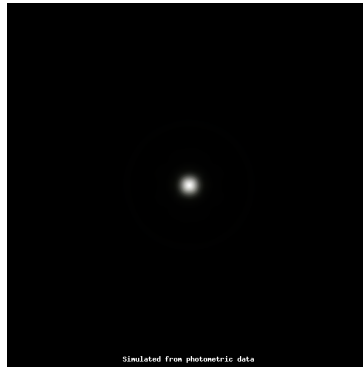

Light distribution files



LED XQ-E HD
 FWHM / FWTM 5.2° / 9.5°
 Efficiency 92 %
 Peak intensity 96.2 cd/lm
 LEDs/each optic 1
 Light colour/type White
 Required components:

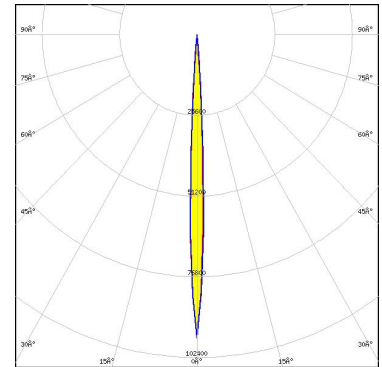

Light distribution files



LED XQ-E HI
 FWHM / FWTM 4.0° / 8.0°
 Efficiency 89 %
 Peak intensity 119.2 cd/lm
 LEDs/each optic 1
 Light colour/type White
 Required components:

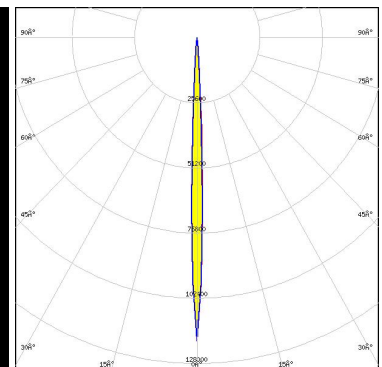
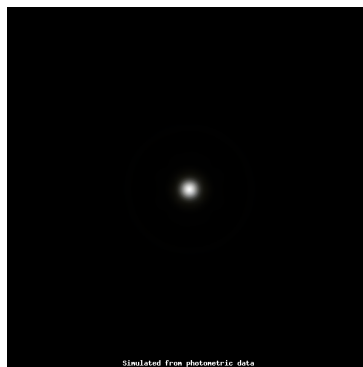

Light distribution files

OPTICAL RESULTS (SIMULATED):



LED LUXEON 3030 2D (Round LES)
 FWHM / FWTM 6.0° / 14.0°
 Efficiency 90 %
 Peak intensity 51.4 cd/lm
 LEDs/each optic 1
 Light colour/type White
 Required components:

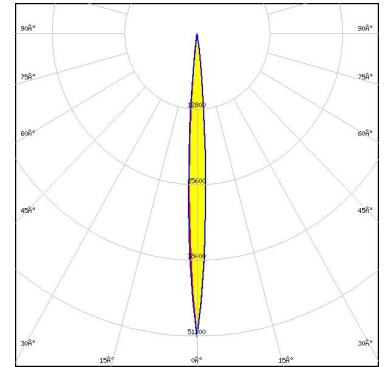

Light distribution files



LED LUXEON Altilon intense 1x1
 FWHM / FWTM 4.0° / 8.0°
 Efficiency 90 %
 Peak intensity 135 cd/lm
 LEDs/each optic 1
 Light colour/type White
 Required components:

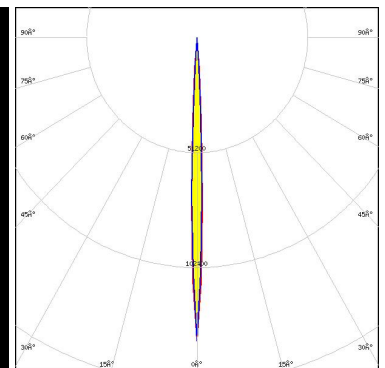
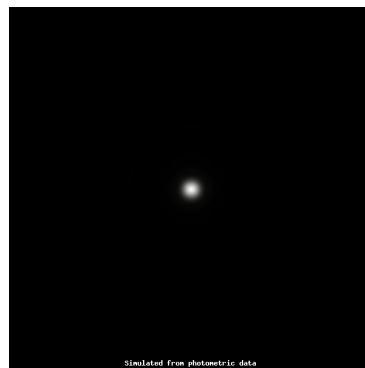

Light distribution files



LED LUXEON CZ
 FWHM / FWTM 4.0° / 8.0°
 Efficiency 90 %
 Peak intensity 120.7 cd/lm
 LEDs/each optic 1
 Light colour/type White
 Required components:

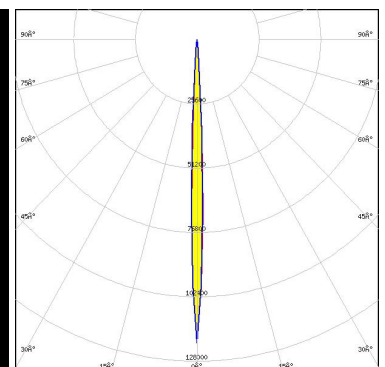
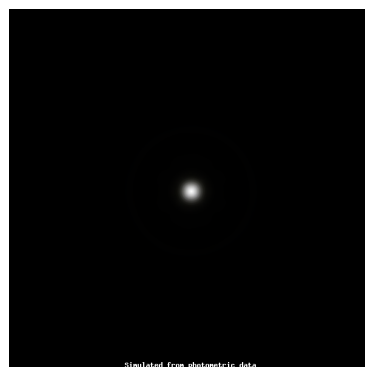

Light distribution files

OPTICAL RESULTS (SIMULATED):



LED LUXEON CZ
FWHM / FWTM 8.0° / 14.0°
Efficiency 92 %
Peak intensity 42 cd/lm
LEDs/each optic 1
Light colour/type Green
Required components:

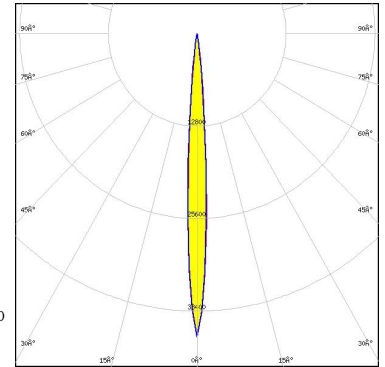
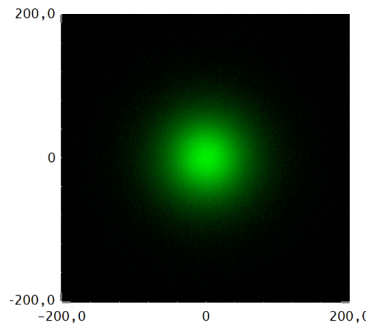

Light distribution files



LED LUXEON HL2X
FWHM / FWTM 8.0° / 14.0°
Efficiency 91 %
Peak intensity 44.1 cd/lm
LEDs/each optic 1
Light colour/type White
Required components:

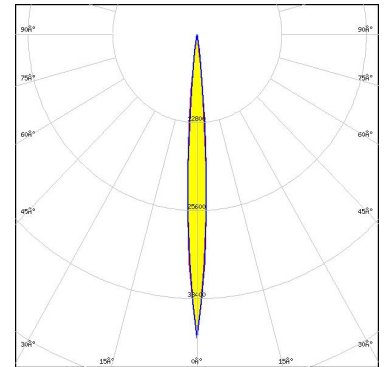

Light distribution files



LED LUXEON HL4Z
FWHM / FWTM 8.0° / 12.0°
Efficiency 92 %
Peak intensity 49.8 cd/lm
LEDs/each optic 1
Light colour/type White
Required components:

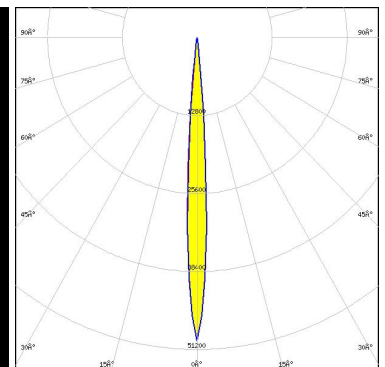
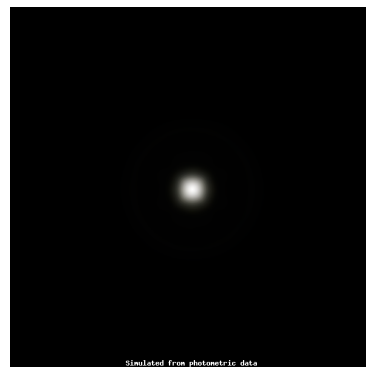

Light distribution files

OPTICAL RESULTS (SIMULATED):



LED LUXEON Rebel Plus
 FWHM / FWTM 6.0° / 10.0°
 Efficiency 91 %
 Peak intensity 75.7 cd/lm
 LEDs/each optic 1
 Light colour/type White
 Required components:

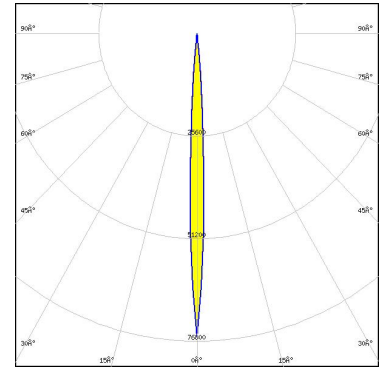

Light distribution files



LED LUXEON Rubix
 FWHM / FWTM 4.0° / 10.0°
 Efficiency 91 %
 Peak intensity 100.1 cd/lm
 LEDs/each optic 1
 Light colour/type Green
 Required components:

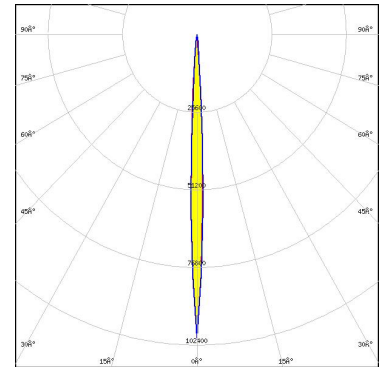

Light distribution files



LED LUXEON Rubix
 FWHM / FWTM 4.0° / 10.0°
 Efficiency 91 %
 Peak intensity 97.1 cd/lm
 LEDs/each optic 1
 Light colour/type White
 Required components:

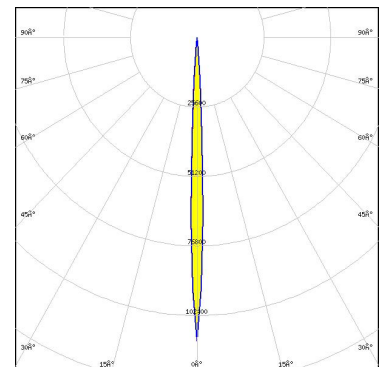

Light distribution files

OPTICAL RESULTS (SIMULATED):

LUMILEDS

LED	LUXEON Rubix
FWHM / FWTM	4.0° / 10.0°
Efficiency	91 %
Peak intensity	99.6 cd/lm
LEDs/each optic	1
Light colour/type	Blue
Required components:	

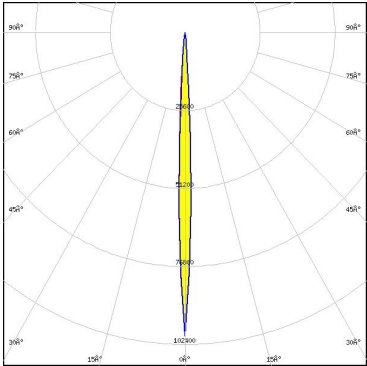

Light distribution files

LUMILEDS

LED	LUXEON Rubix
FWHM / FWTM	4.0° / 10.0°
Efficiency	91 %
Peak intensity	104.2 cd/lm
LEDs/each optic	1
Light colour/type	Red
Required components:	

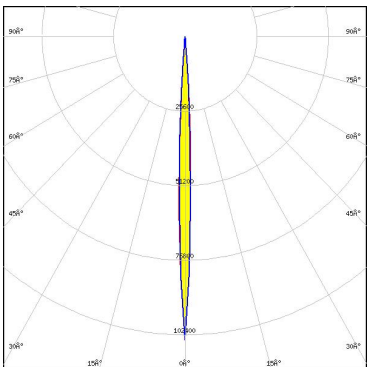

Light distribution files

LUMILEDS

LED	LUXEON Rubix
FWHM / FWTM	4.0° / 8.0°
Efficiency	90 %
Peak intensity	111.8 cd/lm
LEDs/each optic	1
Light colour/type	White
Required components:	

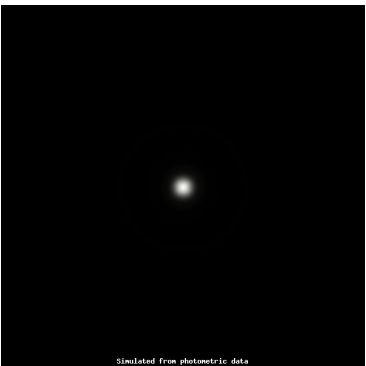

Simulated from photometric data

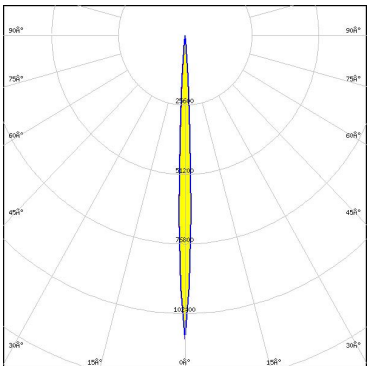

Light distribution files

OPTICAL RESULTS (SIMULATED):



LED SFT-40 Gen2
 FWHM / FWTM 6.0° / 12.0°
 Efficiency 92 %
 Peak intensity 63.3 cd/lm
 LEDs/each optic 1
 Light colour/type White
 Required components:

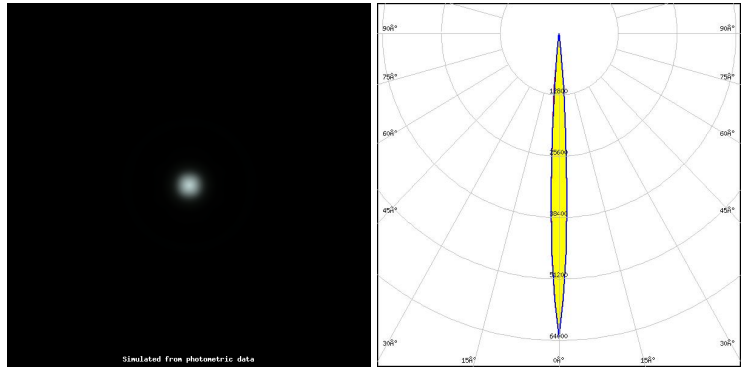

Light distribution files



LED SFT-70X-WES-Gen2
 FWHM / FWTM 8.0° / 14.0°
 Efficiency 92 %
 Peak intensity 39.6 cd/lm
 LEDs/each optic 1
 Light colour/type White
 Required components:

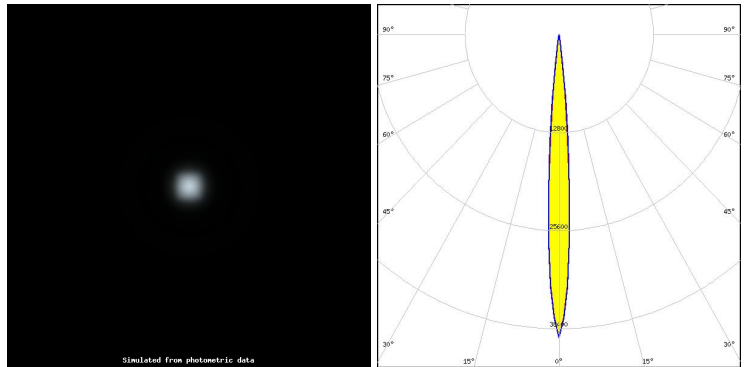

Light distribution files



LED SST-25-W
 FWHM / FWTM 8.0° / 12.0°
 Efficiency 91 %
 Peak intensity 50.5 cd/lm
 LEDs/each optic 1
 Light colour/type White
 Required components:

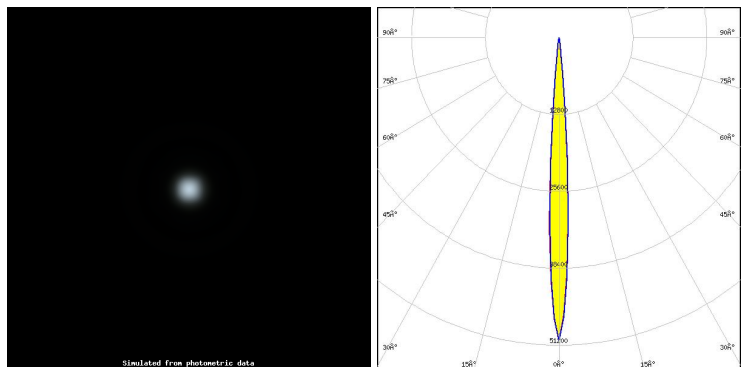

Light distribution files

OPTICAL RESULTS (SIMULATED):



LED NCSxE17A
 FWHM / FWTM 6.0° / 10.0°
 Efficiency 87 %
 Peak intensity 69.3 cd/lm
 LEDs/each optic 1
 Light colour/type White
 Required components:

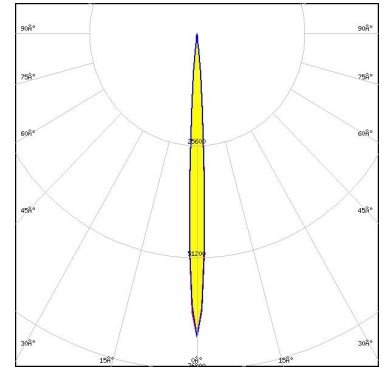

Light distribution files



LED NV4WB35AM
 FWHM / FWTM 10.0° / 16.0°
 Efficiency 92 %
 Peak intensity 26.7 cd/lm
 LEDs/each optic 1
 Light colour/type White
 Required components:

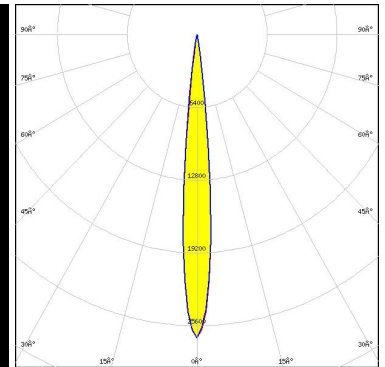
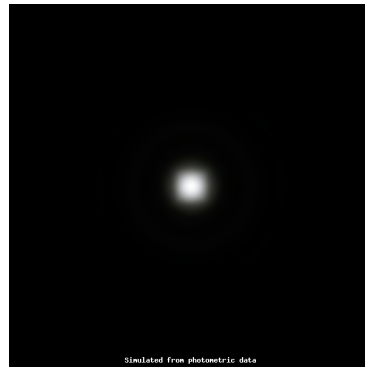

Light distribution files



LED NVSW219C-V2
 FWHM / FWTM 6.0° / 12.0°
 Efficiency 91 %
 Peak intensity 71.2 cd/lm
 LEDs/each optic 1
 Light colour/type White
 Required components:

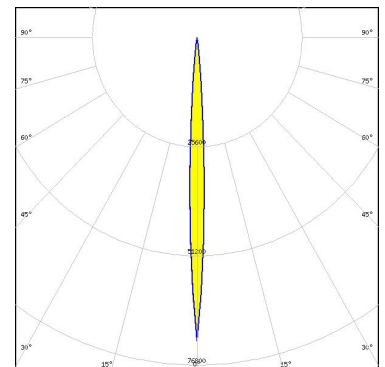

Light distribution files

OPTICAL RESULTS (SIMULATED):



LED NVSxE21A
 FWHM / FWTM 6.0° / 14.0°
 Efficiency 88 %
 Peak intensity 48.2 cd/lm
 LEDs/each optic 1
 Light colour/type White
 Required components:

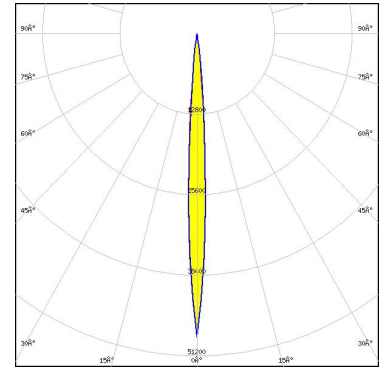

Light distribution files



LED Duris S8
 FWHM / FWTM 13.0° / 21.0°
 Efficiency 92 %
 Peak intensity 16.8 cd/lm
 LEDs/each optic 1
 Light colour/type White
 Required components:

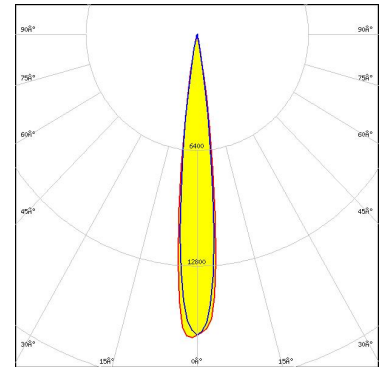

Light distribution files



LED OSOLON Black Flat S (KW HHL532.TK)
 FWHM / FWTM 4.0° / 8.0°
 Efficiency 90 %
 Peak intensity 114.2 cd/lm
 LEDs/each optic 1
 Light colour/type White
 Required components:

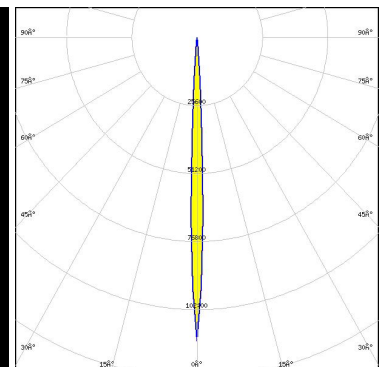
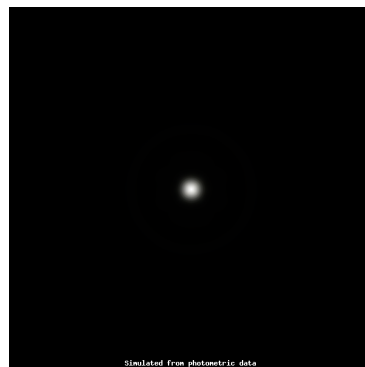

Light distribution files

OPTICAL RESULTS (SIMULATED):

OSRAM
Opto Semiconductors

LED OSLO[®]N Black Flat X (KW HHL631.TK)
 FWHM / FWTM 4.0° / 10.0°
 Efficiency 91 %
 Peak intensity 105.7 cd/lm
 LEDs/each optic 1
 Light colour/type White
 Required components:

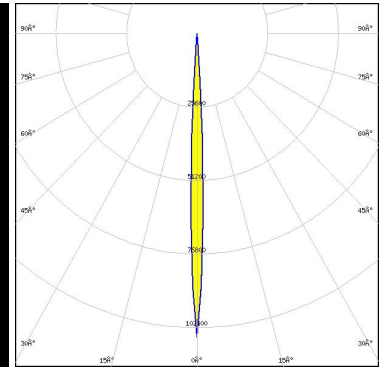
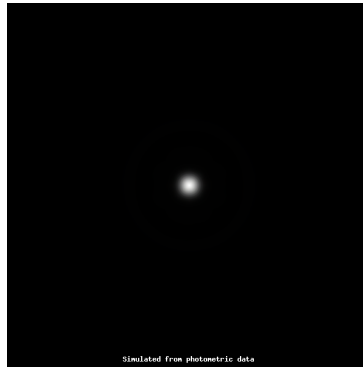

Light distribution files

OSRAM
Opto Semiconductors

LED OSLO[®]N Boost HX (KW CULPM1.TG)
 FWHM / FWTM 6.0° / 10.0°
 Efficiency 91 %
 Peak intensity 91.6 cd/lm
 LEDs/each optic 1
 Light colour/type White
 Required components:

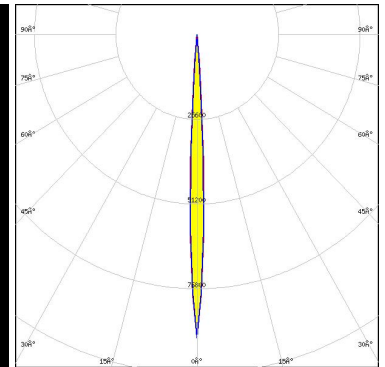
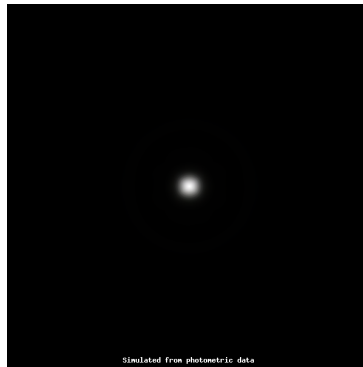

Light distribution files

OSRAM
Opto Semiconductors

LED OSLO[®]N Square CSSRM2/CSSRM3
 FWHM / FWTM 6.4° / 13.0°
 Efficiency 92 %
 Peak intensity 60.7 cd/lm
 LEDs/each optic 1
 Light colour/type White
 Required components:

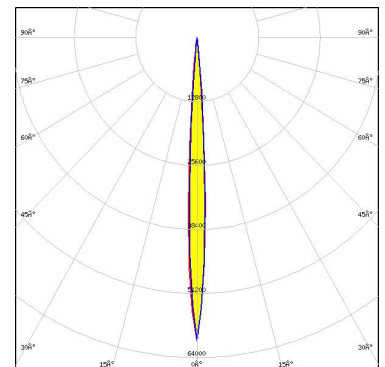

Light distribution files

OPTICAL RESULTS (SIMULATED):

OSRAM
Opto Semiconductors

LED OSTAR Projection Compact (KW.CSLNM1.TG)
 FWHM / FWTM 4.0° / 8.0°
 Efficiency 90 %
 Peak intensity 133.4 cd/lm
 LEDs/each optic 1
 Light colour/type White
 Required components:

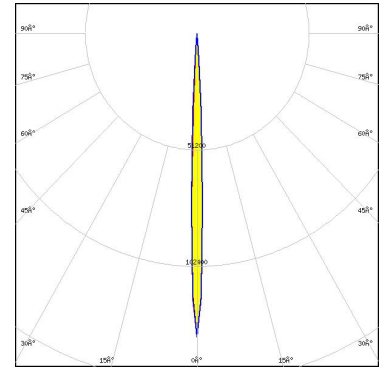

Light distribution files

OSRAM
Opto Semiconductors

LED OSTAR Projection Compact (KW.CSLNM1.TG)
 FWHM / FWTM 4.0° / 10.0°
 Efficiency 91 %
 Peak intensity 103.8 cd/lm
 LEDs/each optic 1
 Light colour/type White
 Required components:

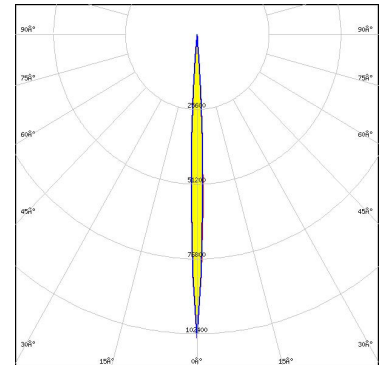

Light distribution files

OSRAM
Opto Semiconductors

LED OSTAR Stage (S2WN)
 FWHM / FWTM 8.0° / 14.0°
 Efficiency 92 %
 Peak intensity 43.1 cd/lm
 LEDs/each optic 1
 Light colour/type RGBW
 Required components:

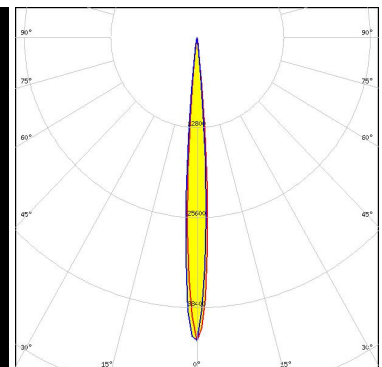
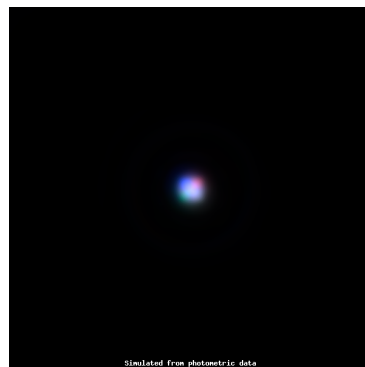

Light distribution files

OPTICAL RESULTS (SIMULATED):

SAMSUNG

LED LM101B
FWHM / FWTM 6.0° / 12.0°
Efficiency 90 %
Peak intensity 69.6 cd/m
LEDs/each optic 1
Light colour/type White
Required components:

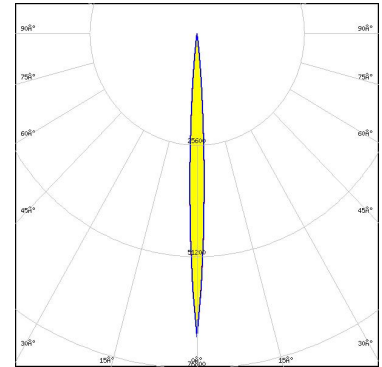

Light distribution files

LEDiL[®]

LED LaserLight SMD 1000
FWHM / FWTM 4.0° / 8.0°
Efficiency 88 %
Peak intensity 144.2 cd/m
LEDs/each optic 1
Light colour/type White
Required components:

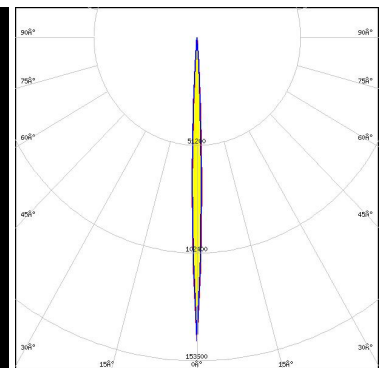

Light distribution files

GENERAL INFORMATION:

NOTE: The typical beam angle will be changed by different color, chip size and chip position tolerance. The typical total beam angle is the full angle measured where the luminous intensity is half of the peak value.

MATERIALS:

As part of our continuous research and improvement processes, and to ensure the best possible quality and availability of our products, LEDiL reserves the right to change material grades without notice.

PRODUCT DATA USER AGREEMENT AND DISCLAIMER:

The measured data in the provided downloadable LEDiL Product Datasheets and Mechanical 2D-Drawings is rounded and provided as reference for planning. LEDiL Oy's optical specifications have been verified by conducting performance testing of the products in accordance with the company's quality system. The reported data are averaged results of multiple measurements with typical variation. LEDiL Oy reserves the right to without prior notification make changes and improvements to its products.

LEDiL Oy assumes neither warranty, nor guarantee nor any other liability of any kind for the contents and correctness of the provided data. The provided data has been generated with highest diligence but the provided data may in reality not represent the complete possible variation range of all intrinsic parameters. Therefore, in certain cases a deviation from the provided data could occur.

LEDiL Oy reserves the right to undertake technical changes of its products without further notification which could lead to changes in the provided data. LEDiL Oy assumes no liability of any kind for the possible deviation from any provided data or any other damage resulting from the usage of the provided data.

The user agrees to this disclaimer and user agreement with the download or usage of the provided files.

LEDiL Oy

Joensuunkatu 7
FI-24240 SALO
Finland

LEDiL Inc.

228 West Page Street
Suite D
Sycamore IL 60178
USA

Ledil Optics Technology (Shenzhen) Co., Ltd.

405 , Block B
Casic Motor Building
Shenzhen 518057
P.R.CHINA

Local sales and technical support

[www.ledil.com/
where_to_buy](http://www.ledil.com/where_to_buy)

Shipping locations

Poznan, Poland
Hong Kong, China

Distribution Partners

[www.ledil.com/
where_to_buy](http://www.ledil.com/where_to_buy)