

## TINA-O

~35° x 15° oval beam. Assembly with holder, installation tape and location pins.

### SPECIFICATION:

Dimensions	Ø 16.1
Height	9.5 mm
Fastening	tape, pin
ROHS compliant	yes ⓘ



### MATERIALS:

Component	Type	Material	Colour	Finish	Length (mm)
TINA-XP-O	Single lens	PMMA	clear		
TINA-HLD-PIN-BLK	Holder	PC	black		
TINA-TAPE3	Tape	Acrylic foam	black		

### ORDERING INFORMATION:

Component	Qty in box	MOQ	MPQ	Box weight (kg)
FA11204_TINA-O	2016	288	144	4.1
» Box size:				

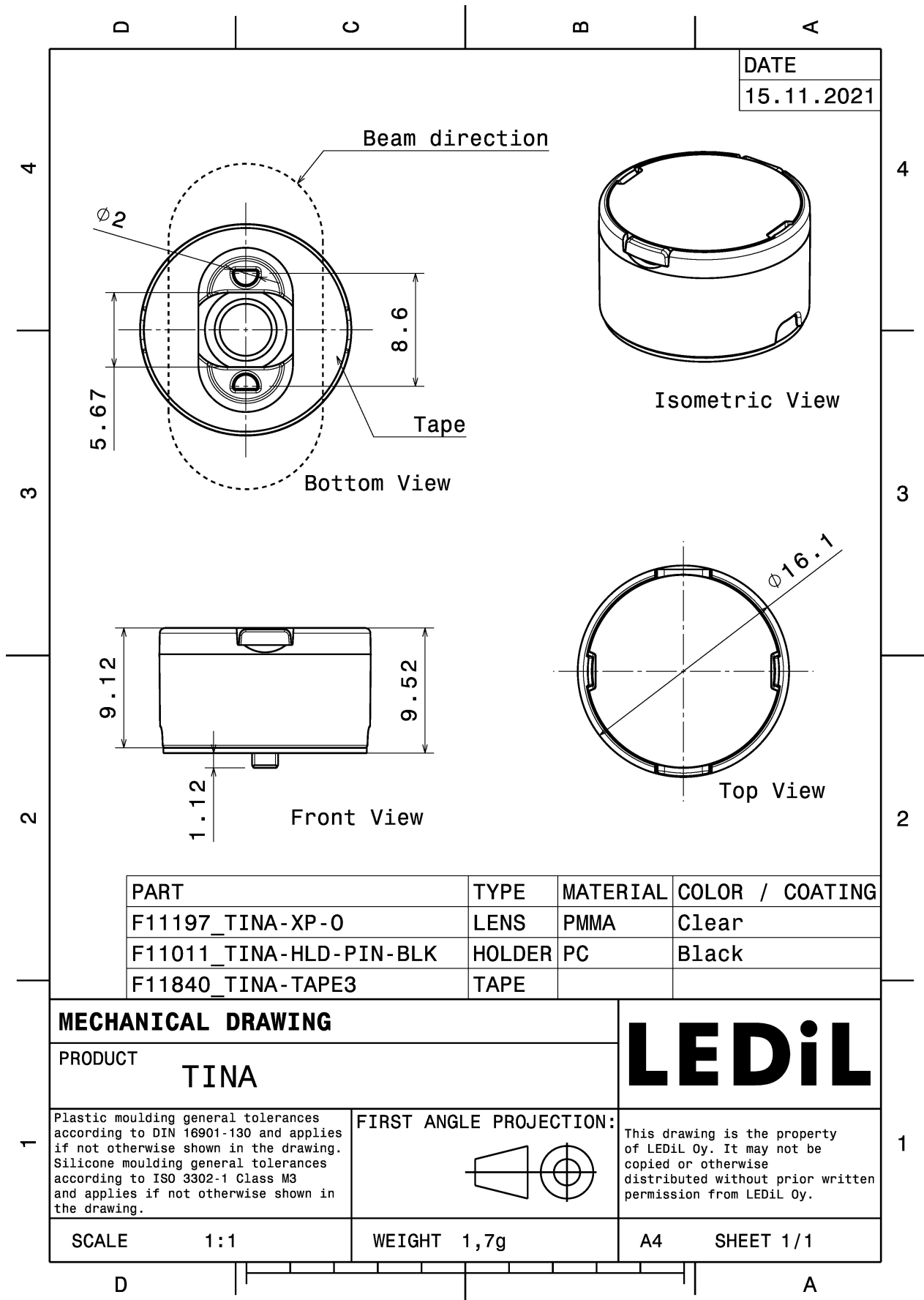

<b>MECHANICAL DRAWING</b>		<b>LEDiL</b>
PRODUCT <b>TINA</b>		
Plastic moulding general tolerances according to DIN 16901-130 and applies if not otherwise shown in the drawing. Silicone moulding general tolerances according to ISO 3302-1 Class M3 and applies if not otherwise shown in the drawing.	FIRST ANGLE PROJECTION: 	This drawing is the property of LEDiL Oy. It may not be copied or otherwise distributed without prior written permission from LEDiL Oy.
SCALE 1:1	WEIGHT 1,7g	A4 SHEET 1/1

See also our general installation guide: [www.ledil.com/installation\\_guide](http://www.ledil.com/installation_guide)

### OPTICAL RESULTS (MEASURED):



LED XB-H  
FWHM / FWTM 38.0 + 16.0° / 63.0 + 37.0°  
Efficiency 83 %  
Peak intensity 3.6 cd/lm  
LEDs/each optic 1  
Light colour/type White  
Required components:

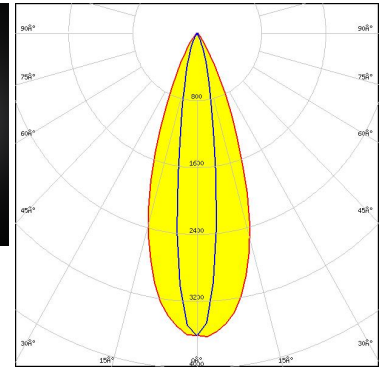
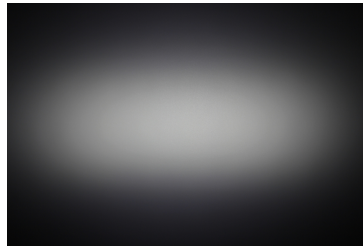

Light distribution files



LED NVSW3x9A  
FWHM / FWTM 37.0 + 20.0° / 67.0 + 41.0°  
Efficiency 82 %  
Peak intensity 2.8 cd/lm  
LEDs/each optic 1  
Light colour/type White  
Required components:

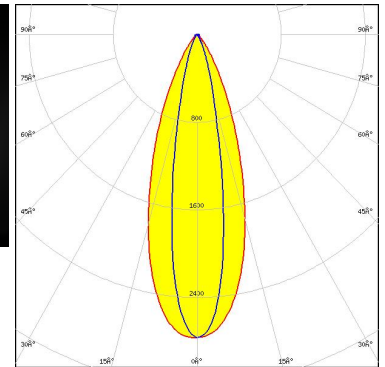

Light distribution files



LED Duris S5 (2 chip)  
FWHM / FWTM 38.0 + 16.0° / 64.0 + 37.0°  
Efficiency 86 %  
Peak intensity 3.4 cd/lm  
LEDs/each optic 1  
Light colour/type White  
Required components:

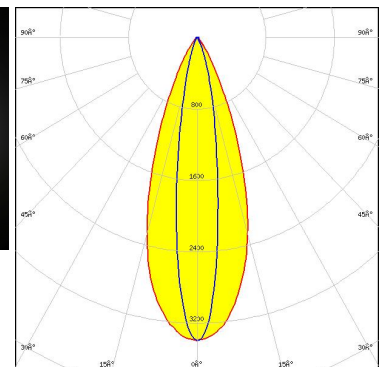
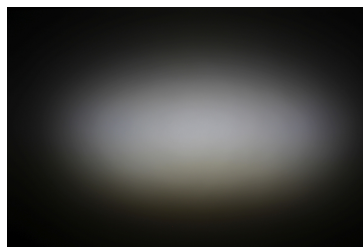

Light distribution files

### OPTICAL RESULTS (MEASURED):

**OSRAM**  
Opto Semiconductors

LED OSLON Black Flat (LUW HWQP)  
FWHM / FWTM 40.0 + 10.0° / 57.0 + 22.0°  
Efficiency 86 %  
Peak intensity 5.6 cd/lm  
LEDs/each optic 1  
Light colour/type White  
Required components:

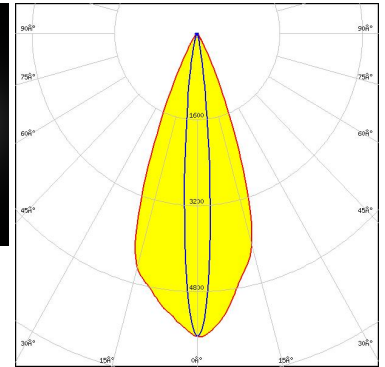

Light distribution files

**OSRAM**  
Opto Semiconductors

LED OSLON SSL 150  
FWHM / FWTM 32.0 + 14.0° / 58.0 + 30.0°  
Efficiency 91 %  
Peak intensity 3.3 cd/lm  
LEDs/each optic 1  
Light colour/type White  
Required components:

Light distribution files

**OSRAM**  
Opto Semiconductors

LED OSLON SSL 80  
FWHM / FWTM 34.0 + 12.0° / 56.0 + 32.0°  
Efficiency 80 %  
Peak intensity 3.8 cd/lm  
LEDs/each optic 1  
Light colour/type White  
Required components:

Light distribution files

### OPTICAL RESULTS (MEASURED):

**OSRAM**  
Opto Semiconductors

LED SFH 4715S  
FWHM / FWTM 40.0 + 16.0° / 31.0 + 60.0°  
Efficiency 0 %  
LEDs/each optic 1  
Light colour/type White  
Required components:

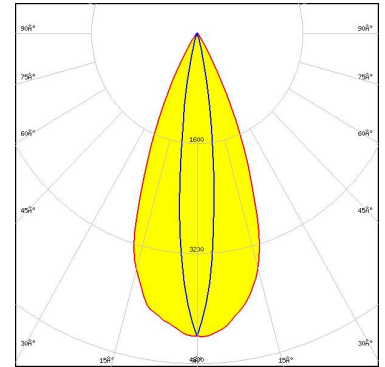

Light distribution files

**OSRAM**  
Opto Semiconductors

LED SFH 4725S  
FWHM / FWTM 39.0 + 15.0° / 62.0 + 32.0°  
Efficiency %  
LEDs/each optic 1  
Light colour/type White  
Required components:

Light distribution files

**SAMSUNG**

LED LH351A  
FWHM / FWTM 34.0 + 16.0° / 62.0 + 39.0°  
Efficiency 90 %  
Peak intensity 2.5 cd/lm  
LEDs/each optic 1  
Light colour/type White  
Required components:

Light distribution files

### OPTICAL RESULTS (MEASURED):

 SEOL SEMICONDUCTOR		
LED	Z8Y22P	
FWHM / FWTM	37.0 + 18.0° / 66.0 + 41.0°	
Efficiency	79 %	
Peak intensity	2.7 cd/lm	
LEDs/each optic	1	
Light colour/type	White	
Required components:		

Light distribution files

### OPTICAL RESULTS (SIMULATED):



**LED** LUXEON Z ES  
**FWHM / FWTM** 40.0 + 11.0° / 60.0 + 24.0°  
**Efficiency** 91 %  
**Peak intensity** 5.3 cd/lm  
**LEDs/each optic** 1  
**Light colour/type** White  
**Required components:**

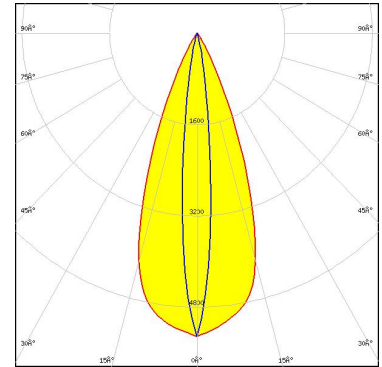

Light distribution files



**LED** NCSxE17A  
**FWHM / FWTM** 42.0 + 12.0° / 60.0 + 24.0°  
**Efficiency** 88 %  
**Peak intensity** 4.8 cd/lm  
**LEDs/each optic** 1  
**Light colour/type** White  
**Required components:**

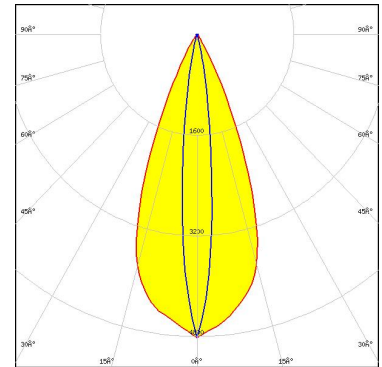

Light distribution files



**LED** NVSxx19B/NVSxx19C  
**FWHM / FWTM** 38.0 + 17.0°  
**Efficiency** 85 %  
**Peak intensity** 3.5 cd/lm  
**LEDs/each optic** 1  
**Light colour/type** White  
**Required components:**

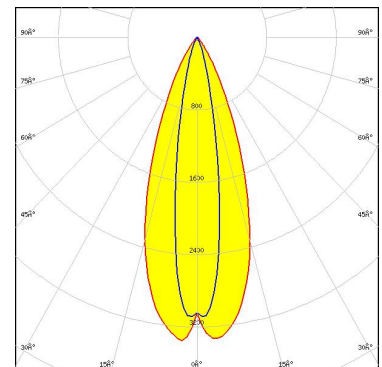

Light distribution files

### OPTICAL RESULTS (SIMULATED):

**OSRAM**  
Opto Semiconductors

LED SFH 4715AS  
FWHM / FWTM 44.0 + 15.0° / 62.0 + 30.0°  
Efficiency 89 %  
LEDs/each optic 1  
Light colour/type White  
Required components:

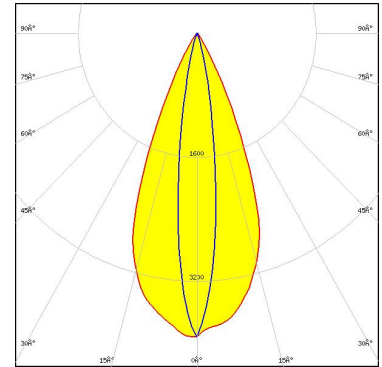

Light distribution files

**OSRAM**  
Opto Semiconductors

LED SYNIOS S2222  
FWHM / FWTM 38.0 + 12.0° / 61.0 + 26.0°  
Efficiency 96 %  
Peak intensity 5.2 cd/lm  
LEDs/each optic 1  
Light colour/type White  
Required components:

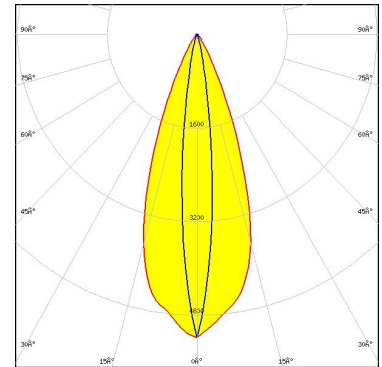

Light distribution files

**SAMSUNG**

LED LM302D  
FWHM / FWTM 41.0 + 16.0° / 64.0 + 34.0°  
Efficiency 88 %  
Peak intensity 3.5 cd/lm  
LEDs/each optic 1  
Light colour/type White  
Required components:

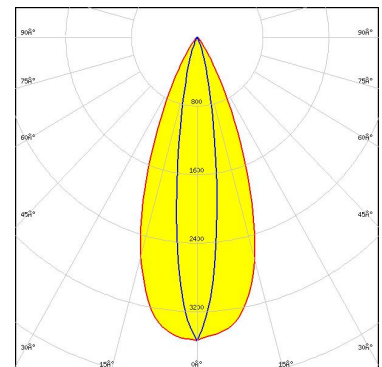

Light distribution files



### GENERAL INFORMATION:

NOTE: The typical beam angle will be changed by different color, chip size and chip position tolerance. The typical total beam angle is the full angle measured where the luminous intensity is half of the peak value.

### MATERIALS:

As part of our continuous research and improvement processes, and to ensure the best possible quality and availability of our products, LEDiL reserves the right to change material grades without notice.

### PRODUCT DATA USER AGREEMENT AND DISCLAIMER:

The measured data in the provided downloadable LEDiL Product Datasheets and Mechanical 2D-Drawings is rounded and provided as reference for planning. LEDiL Oy's optical specifications have been verified by conducting performance testing of the products in accordance with the company's quality system. The reported data are averaged results of multiple measurements with typical variation. LEDiL Oy reserves the right to without prior notification make changes and improvements to its products.

LEDiL Oy assumes neither warranty, nor guarantee nor any other liability of any kind for the contents and correctness of the provided data. The provided data has been generated with highest diligence but the provided data may in reality not represent the complete possible variation range of all intrinsic parameters. Therefore, in certain cases a deviation from the provided data could occur.

LEDiL Oy reserves the right to undertake technical changes of its products without further notification which could lead to changes in the provided data. LEDiL Oy assumes no liability of any kind for the possible deviation from any provided data or any other damage resulting from the usage of the provided data.

The user agrees to this disclaimer and user agreement with the download or usage of the provided files.

#### LEDiL Oy

Joensuunkatu 7  
FI-24240 SALO  
Finland

#### LEDiL Inc.

228 West Page Street  
Suite D  
Sycamore IL 60178  
USA

#### Ledil Optics Technology (Shenzhen) Co., Ltd.

# 405 , Block B  
Casic Motor Building  
Shenzhen 518057  
P.R.CHINA

#### Local sales and technical support

[www.ledil.com/  
where\\_to\\_buy](http://www.ledil.com/where_to_buy)

#### Shipping locations

Poznan, Poland  
Hong Kong, China

#### Distribution Partners

[www.ledil.com/  
where\\_to\\_buy](http://www.ledil.com/where_to_buy)