

## TINA-W

~50° wide beam optimized for LUXEON Rebel.  
Assembly with holder, installation tape and location pins.

### SPECIFICATION:

Dimensions	Ø 16.1 mm
Height	9.4 mm
Fastening	tape, pin
ROHS compliant	yes ⓘ



### MATERIALS:

Component	Type	Material	Colour	Finish	Length
TINA-XP-W	Single lens	PMMA	clear		16.0
TINA-H-TAPE-RE-BLK	Holder	PC	black		16.0
TINA-TAPE3	Tape	Acrylic foam	black		16.0

### ORDERING INFORMATION:

Component	Qty in box	MOQ	MPQ	Box weight (kg)
FA11211_TINA-W » Box size:	2016	288	144	4.1

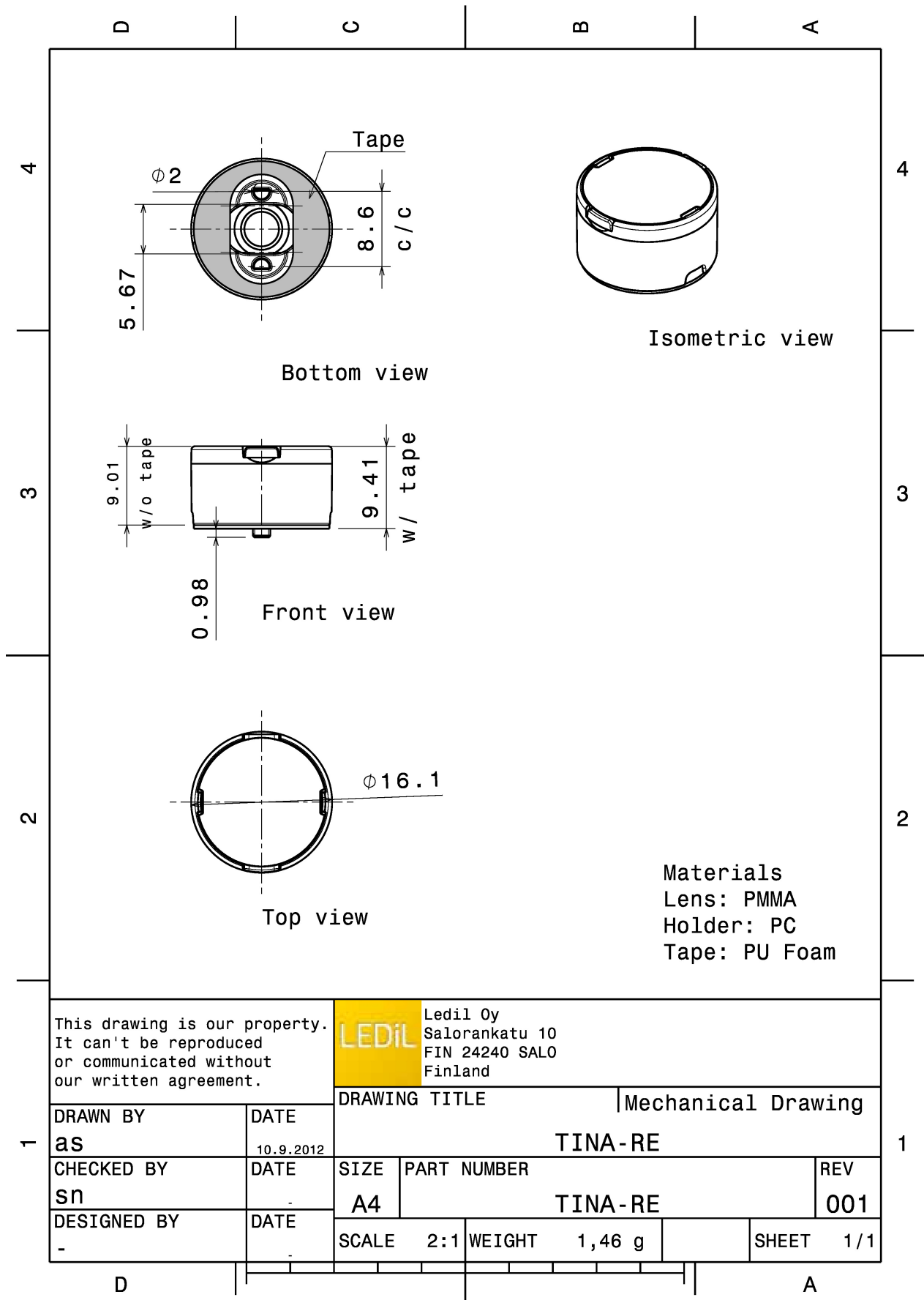

This drawing is our property. It can't be reproduced or communicated without our written agreement.		<b>LEDiL</b> LediL Oy Salorankatu 10 FIN 24240 SALO Finland	
DRAWN BY <b>as</b>		DATE 10.9.2012	
CHECKED BY <b>sn</b>		DATE -	
DESIGNED BY -		DATE -	
DRAWING TITLE <b>TINA-RE</b>		Mechanical Drawing	
SIZE <b>A4</b>	PART NUMBER <b>TINA-RE</b>	REV <b>001</b>	
SCALE <b>2:1</b>	WEIGHT <b>1,46 g</b>	SHEET <b>1/1</b>	

See also our general installation guide: [www.ledil.com/installation\\_guide](http://www.ledil.com/installation_guide)

### OPTICAL RESULTS (MEASURED):



**LED** XB-H  
**FWHM / FWTM** 56.0° / 75.0°  
**Efficiency** 89 %  
**Peak intensity** 1 cd/m  
**LEDs/each optic** 1  
**Light colour/type** White  
**Required components:**

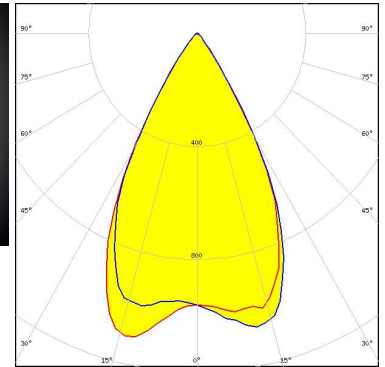
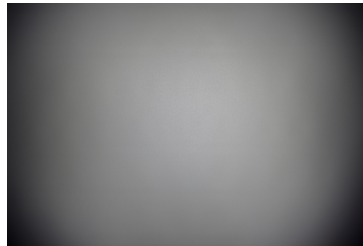

Light distribution files



**LED** LUXEON Rebel  
**FWHM / FWTM** 44.0° / 61.0°  
**Efficiency** 88 %  
**Peak intensity** 1.6 cd/m  
**LEDs/each optic** 1  
**Light colour/type** White  
**Required components:**

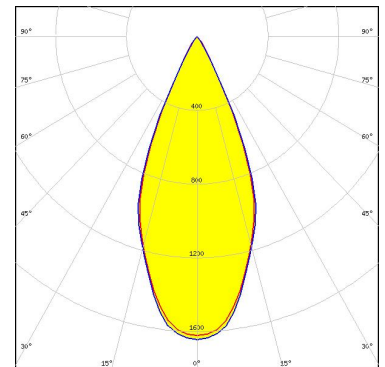

Light distribution files



**LED** LUXEON Z ES  
**FWHM / FWTM** 46.0° / 66.0°  
**Efficiency** 90 %  
**Peak intensity** 1.7 cd/m  
**LEDs/each optic** 1  
**Light colour/type** White  
**Required components:**

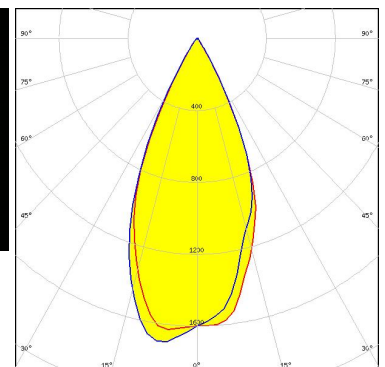
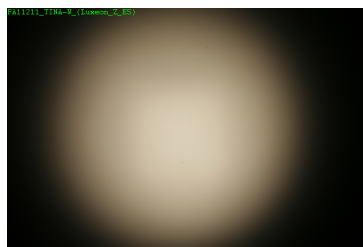

Light distribution files

### OPTICAL RESULTS (SIMULATED):



**LED** XB-D  
**FWHM / FWTM** 42.0° / 66.0°  
**Efficiency** 90 %  
**Peak intensity** 1.8 cd/lm  
**LEDs/each optic** 1  
**Light colour/type** White  
**Required components:**

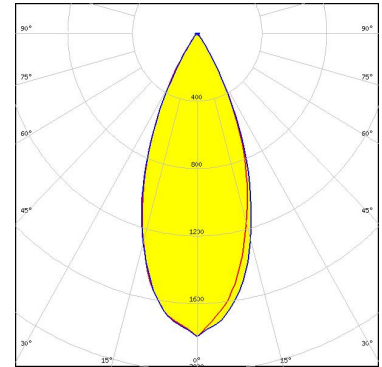

Light distribution files



**LED** XQ-E HI  
**FWHM / FWTM** 42.0° / 67.0°  
**Efficiency** 92 %  
**Peak intensity** 1.9 cd/lm  
**LEDs/each optic** 1  
**Light colour/type** White  
**Required components:**

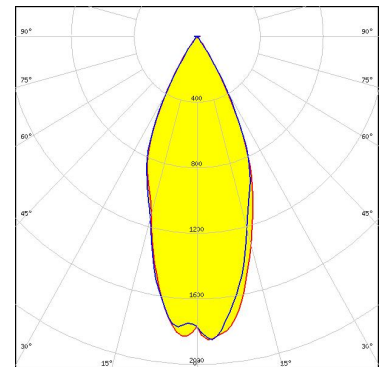

Light distribution files



**LED** LUXEON H50-2  
**FWHM / FWTM** 52.0° / 66.0°  
**Efficiency** 92 %  
**Peak intensity** 1.3 cd/lm  
**LEDs/each optic** 1  
**Light colour/type** White  
**Required components:**

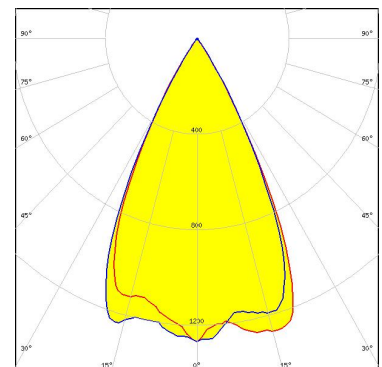

Light distribution files

### OPTICAL RESULTS (SIMULATED):



LED LUXEON HL1Z  
FWHM / FWTM 26.0 + 27.0° / 56.0°  
Efficiency 92 %  
Peak intensity 3.2 cd/lm  
LEDs/each optic 1  
Light colour/type White  
Required components:

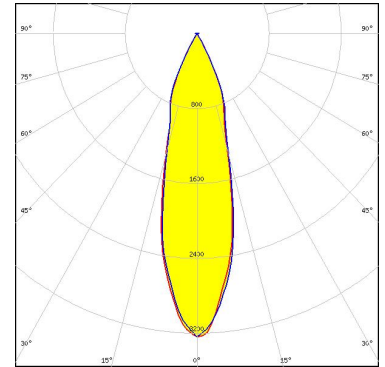

Light distribution files



LED LUXEON HL2Z  
FWHM / FWTM 36.0° / 60.0°  
Efficiency 93 %  
Peak intensity 2.3 cd/lm  
LEDs/each optic 1  
Light colour/type White  
Required components:

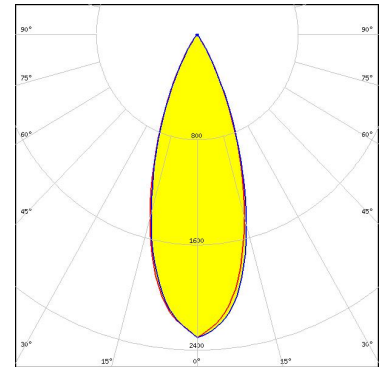

Light distribution files

### GENERAL INFORMATION:

NOTE: The typical beam angle will be changed by different color, chip size and chip position tolerance. The typical total beam angle is the full angle measured where the luminous intensity is half of the peak value.

### MATERIALS:

As part of our continuous research and improvement processes, and to ensure the best possible quality and availability of our products, LEDiL reserves the right to change material grades without notice.

### PRODUCT DATA USER AGREEMENT AND DISCLAIMER:

The measured data in the provided downloadable LEDiL Product Datasheets and Mechanical 2D-Drawings is rounded and provided as reference for planning. LEDiL Oy's optical specifications have been verified by conducting performance testing of the products in accordance with the company's quality system. The reported data are averaged results of multiple measurements with typical variation. LEDiL Oy reserves the right to without prior notification make changes and improvements to its products.

LEDiL Oy assumes neither warranty, nor guarantee nor any other liability of any kind for the contents and correctness of the provided data. The provided data has been generated with highest diligence but the provided data may in reality not represent the complete possible variation range of all intrinsic parameters. Therefore, in certain cases a deviation from the provided data could occur.

LEDiL Oy reserves the right to undertake technical changes of its products without further notification which could lead to changes in the provided data. LEDiL Oy assumes no liability of any kind for the possible deviation from any provided data or any other damage resulting from the usage of the provided data.

The user agrees to this disclaimer and user agreement with the download or usage of the provided files.

#### LEDiL Oy

Joensuunkatu 13  
FI-24240 SALO  
Finland

#### LEDiL Inc.

228 West Page Street  
Suite D  
Sycamore IL 60178  
USA

#### Ledil Optics Technology (Shenzhen) Co., Ltd.

# 405 , Block B  
Casic Motor Building  
Shenzhen 518057  
P.R.CHINA

#### Local sales and technical support

[www.ledil.com/  
where\\_to\\_buy](http://www.ledil.com/where_to_buy)

#### Shipping locations

Poznan, Poland  
Hong Kong, China

#### Distribution Partners

[www.ledil.com/  
where\\_to\\_buy](http://www.ledil.com/where_to_buy)