

TINA-M2

~30° medium beam. Assembly with holder and installation tape.

SPECIFICATION:

Dimensions	Ø 16.1
Height	9.7 mm
Fastening	tape
ROHS compliant	yes ⓘ



MATERIALS:

Component	Type	Material	Colour	Finish	Length (mm)
TINA-M2	Single lens	PMMA	clear		
TINA-XP-H-TAPE-WHT	Holder	PC	white		
TINA-TAPE3	Tape	Acrylic foam	black		

ORDERING INFORMATION:

Component	Qty in box	MOQ	MPQ	Box weight (kg)
FA13093_TINA-M2	2016	288	144	4.2
» Box size:				

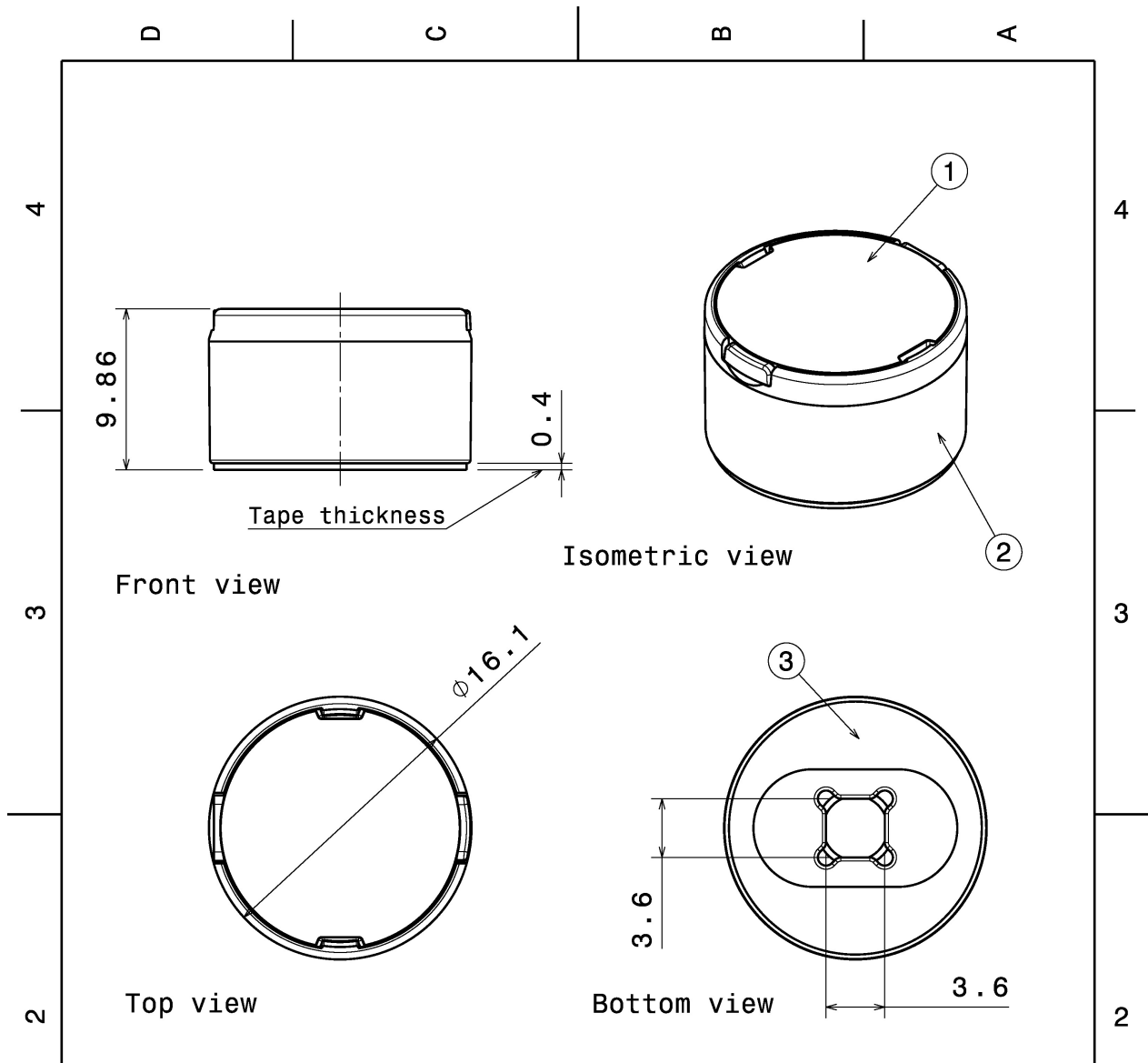

INDEX	PART NO	DESCRIPTION	MATERIAL	COLOUR
1	F12953	TINA-M2	PMMA	clear
2	F10637	TINA-XP-H-TAPE-WHT	PC	white
3	F11840	TINA-TAPE3	Acrylic foam	black

Tolerances if not otherwise shown
According to DIN ISO 2768-1
Linear measures: class C
According to DIN ISO 2768-2
Form and position: class L

LEDiL Ledil Oy
Salorankatu 10
FIN 24240 SALO
Finland

THIRD ANGLE PROJECTION:

DRAWING TITLE
FA13093_TINA-M2

This drawing is the property of LEDiL Oy. It may not be reproduced, copied or communicated without a written agreement with LEDiL Oy.

SIZE	PART NUMBER
A4	FA13093

SCALE	1:1	WEIGHT	3,7 g	SHEET	1/1
-------	-----	--------	-------	-------	-----

See also our general installation guide: www.ledil.com/installation_guide

OPTICAL RESULTS (MEASURED):



LED XT-E
FWHM / FWTM 28.0° / 48.0°
Efficiency 91 %
Peak intensity 3.8 cd/lm
LEDs/each optic 1
Light colour/type White
Required components:

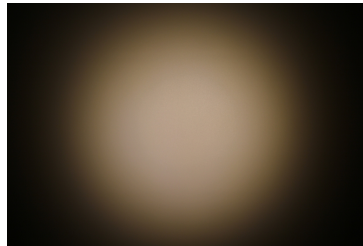

Light distribution files



LED LUXEON 2835 Line
FWHM / FWTM 25.0° / 44.0°
Efficiency 95 %
Peak intensity 4.2 cd/lm
LEDs/each optic 1
Light colour/type White
Required components:

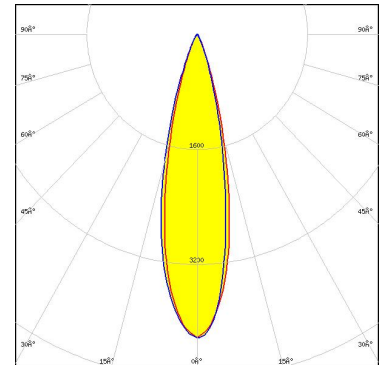

Light distribution files



LED OSLOM SSL 150
FWHM / FWTM 27.0° / 41.0°
Efficiency 94 %
Peak intensity 4.4 cd/lm
LEDs/each optic 1
Light colour/type White
Required components:

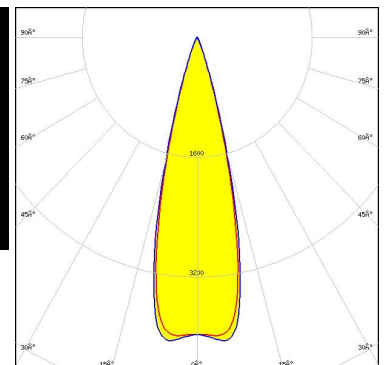
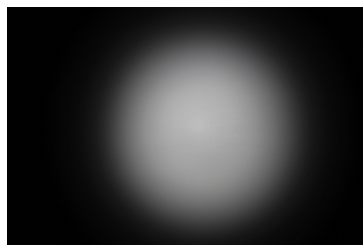

Light distribution files

OPTICAL RESULTS (SIMULATED):

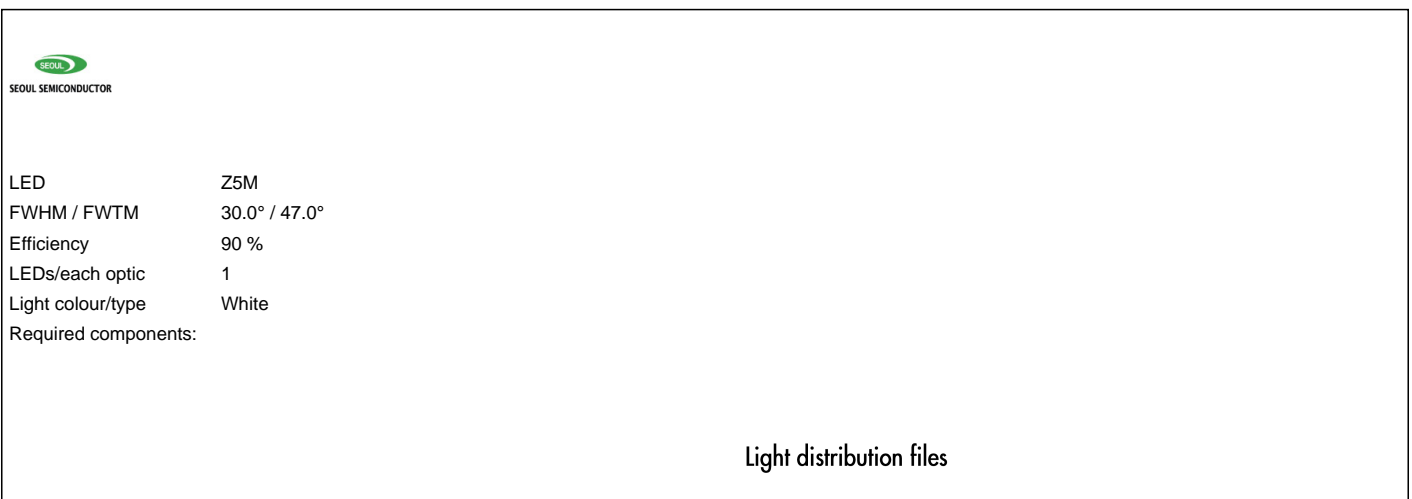
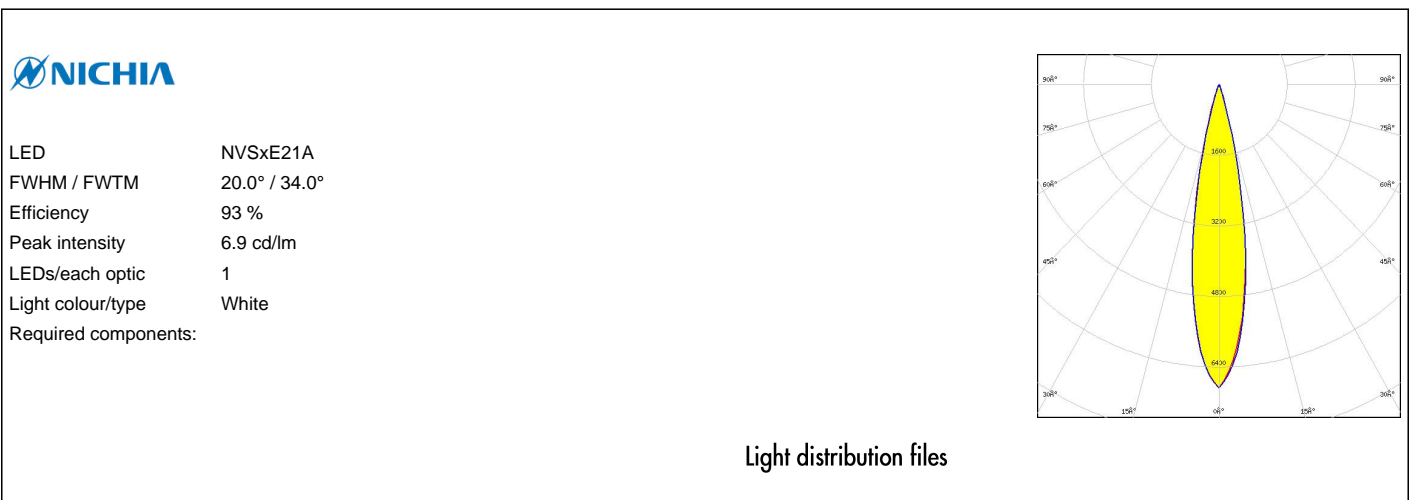
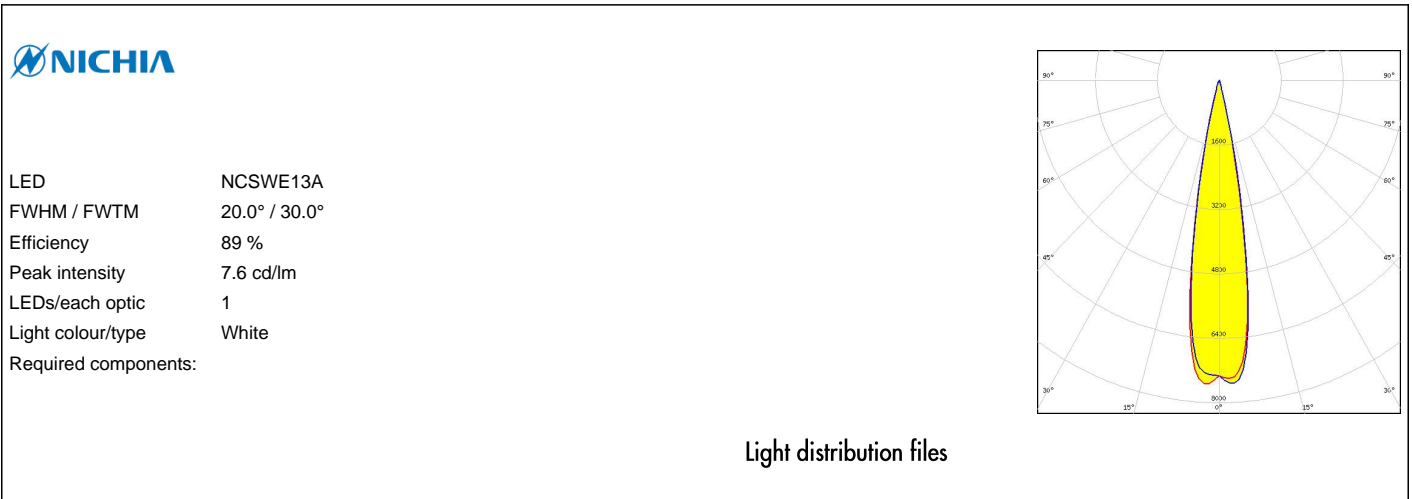

GENERAL INFORMATION:

NOTE: The typical beam angle will be changed by different color, chip size and chip position tolerance. The typical total beam angle is the full angle measured where the luminous intensity is half of the peak value.

MATERIALS:

As part of our continuous research and improvement processes, and to ensure the best possible quality and availability of our products, LEDiL reserves the right to change material grades without notice.

PRODUCT DATA USER AGREEMENT AND DISCLAIMER:

The measured data in the provided downloadable LEDiL Product Datasheets and Mechanical 2D-Drawings is rounded and provided as reference for planning. LEDiL Oy's optical specifications have been verified by conducting performance testing of the products in accordance with the company's quality system. The reported data are averaged results of multiple measurements with typical variation. LEDiL Oy reserves the right to without prior notification make changes and improvements to its products.

LEDiL Oy assumes neither warranty, nor guarantee nor any other liability of any kind for the contents and correctness of the provided data. The provided data has been generated with highest diligence but the provided data may in reality not represent the complete possible variation range of all intrinsic parameters. Therefore, in certain cases a deviation from the provided data could occur.

LEDiL Oy reserves the right to undertake technical changes of its products without further notification which could lead to changes in the provided data. LEDiL Oy assumes no liability of any kind for the possible deviation from any provided data or any other damage resulting from the usage of the provided data.

The user agrees to this disclaimer and user agreement with the download or usage of the provided files.

LEDiL Oy

Joensuunkatu 7
FI-24240 SALO
Finland

LEDiL Inc.

228 West Page Street
Suite D
Sycamore IL 60178
USA

Ledil Optics Technology (Shenzhen) Co., Ltd.

405 , Block B
Casic Motor Building
Shenzhen 518057
P.R.CHINA

Local sales and technical support

[www.ledil.com/
where_to_buy](http://www.ledil.com/where_to_buy)

Shipping locations

Poznan, Poland
Hong Kong, China

Distribution Partners

[www.ledil.com/
where_to_buy](http://www.ledil.com/where_to_buy)