

VERONICA-RS

~12° spot beam

SPECIFICATION:

Dimensions	Ø 26.0
Height	12.2 mm
Fastening	glue, pin
ROHS compliant	yes ⓘ

MATERIALS:

Component	Type	Material	Colour	Finish	Length (mm)
VERONICA-RS	Single lens	PMMA	clear		



ORDERING INFORMATION:

Component	Qty in box	MOQ	MPQ	Box weight (kg)
C13528_VERONICA-RS » Box size: 480 x 280 x 300 mm	2240	336	112	11.1

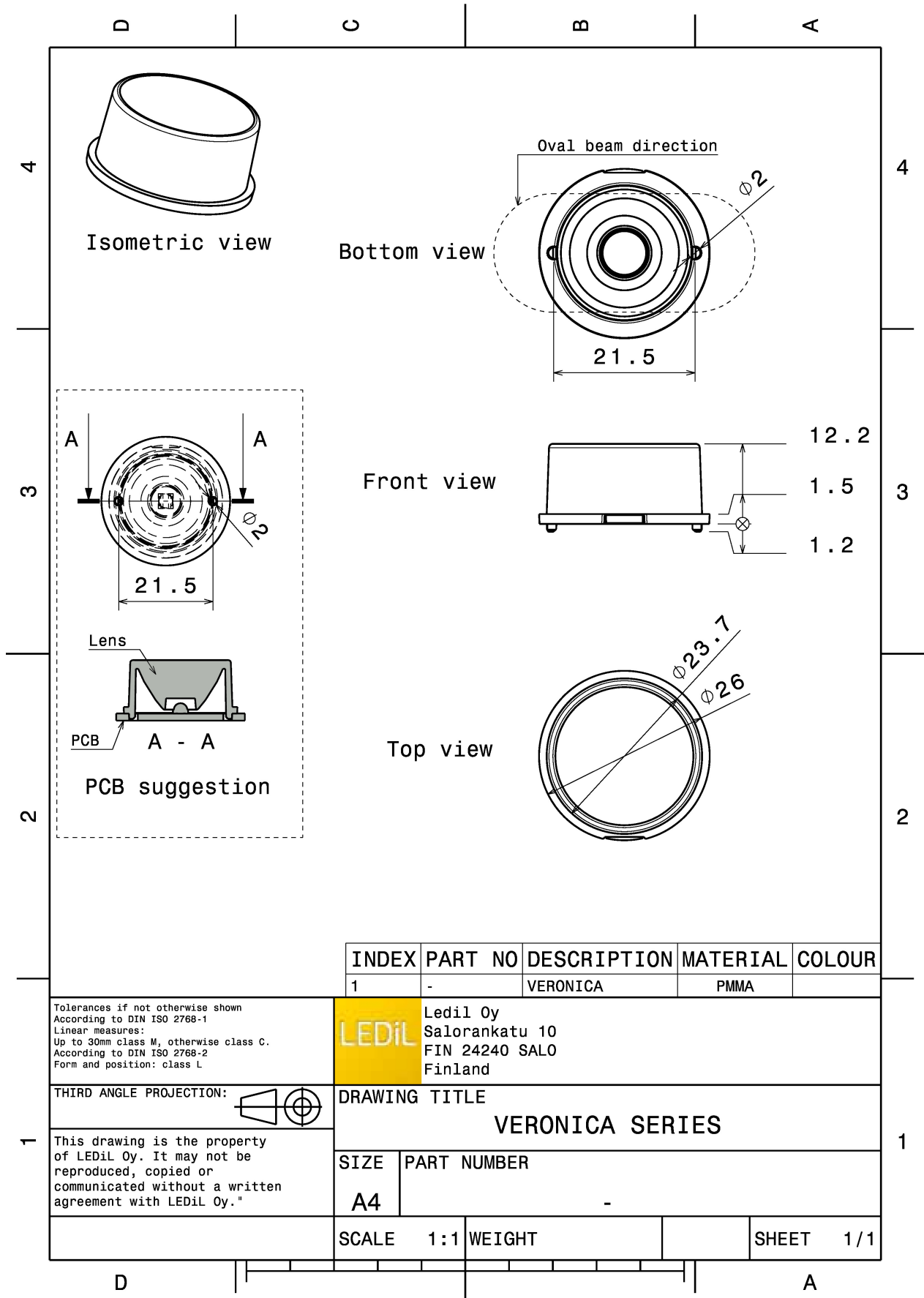

See also our general installation guide: www.ledil.com/installation_guide

OPTICAL RESULTS (MEASURED):



LED XB-H
FWHM / FWTM 11.0° / 24.0°
Efficiency 89 %
Peak intensity 15.9 cd/lm
LEDs/each optic 1
Light colour/type White
Required components:

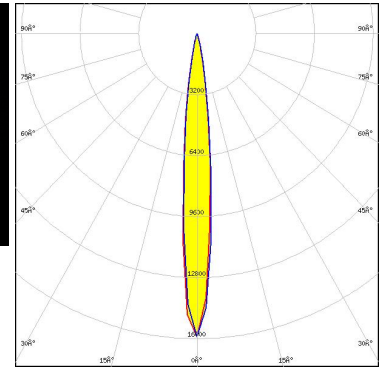

Light distribution files



LED XM-L2
FWHM / FWTM 16.0° / 32.0°
Efficiency 90 %
Peak intensity 8.5 cd/lm
LEDs/each optic 1
Light colour/type White
Required components:

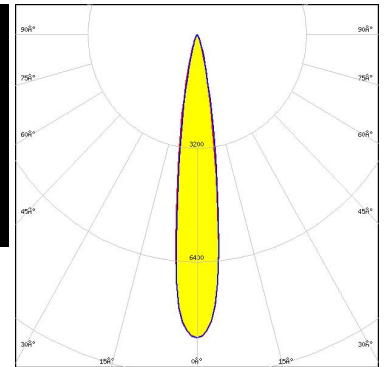

Light distribution files



LED XP-G
FWHM / FWTM 12.0° / 22.0°
Efficiency 90 %
Peak intensity 18.4 cd/lm
LEDs/each optic 1
Light colour/type White
Required components:

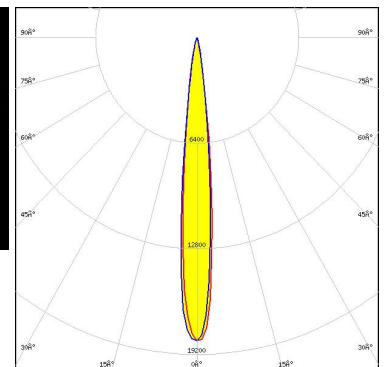

Light distribution files

OPTICAL RESULTS (MEASURED):



LED XP-G2
 FWHM / FWTM 10.0° / 21.0°
 Efficiency 90 %
 Peak intensity 19 cd/lm
 LEDs/each optic 1
 Light colour/type White
 Required components:

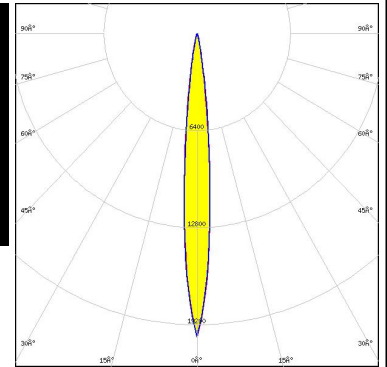
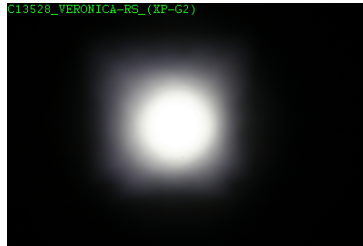

Light distribution files



LED LUXEON A
 FWHM / FWTM 13.0° / 25.0°
 Efficiency 89 %
 Peak intensity 14.7 cd/lm
 LEDs/each optic 1
 Light colour/type White
 Required components:

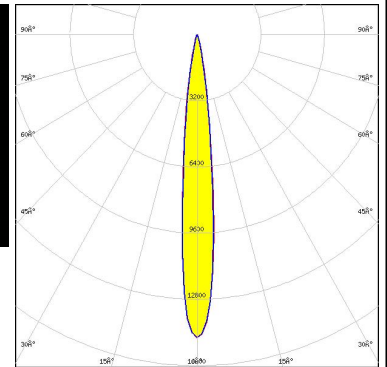

Light distribution files



LED LUXEON Rebel
 FWHM / FWTM 12.0° / 25.0°
 Efficiency 88 %
 Peak intensity 14.9 cd/lm
 LEDs/each optic 1
 Light colour/type White
 Required components:

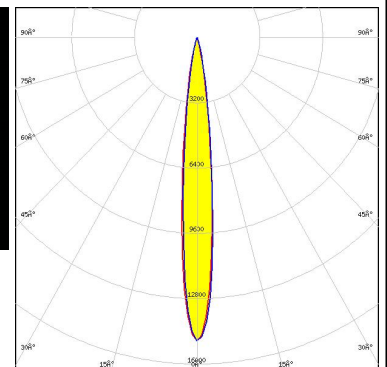

Light distribution files

OPTICAL RESULTS (MEASURED):



LED LUXEON V2
 FWHM / FWTM 12.0° / 25.0°
 Efficiency 94 %
 Peak intensity 13.5 cd/lm
 LEDs/each optic 1
 Light colour/type White
 Required components:

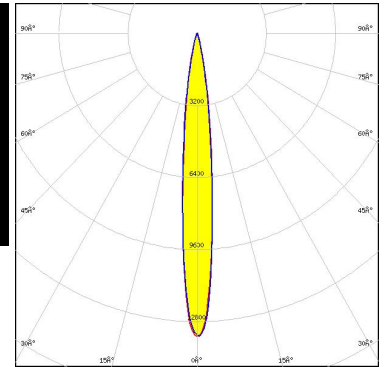

Light distribution files



LED NCSxx19A
 FWHM / FWTM 13.0° / 25.0°
 Efficiency 86 %
 Peak intensity 15 cd/lm
 LEDs/each optic 1
 Light colour/type White
 Required components:

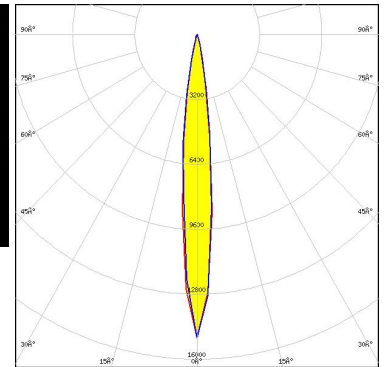

Light distribution files



LED NVSW219F
 FWHM / FWTM 13.0° / 24.0°
 Efficiency 94 %
 Peak intensity 13.3 cd/lm
 LEDs/each optic 1
 Light colour/type White
 Required components:

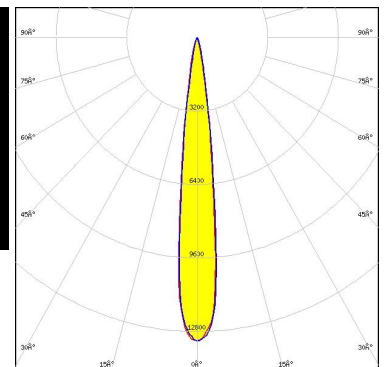

Light distribution files

OPTICAL RESULTS (MEASURED):

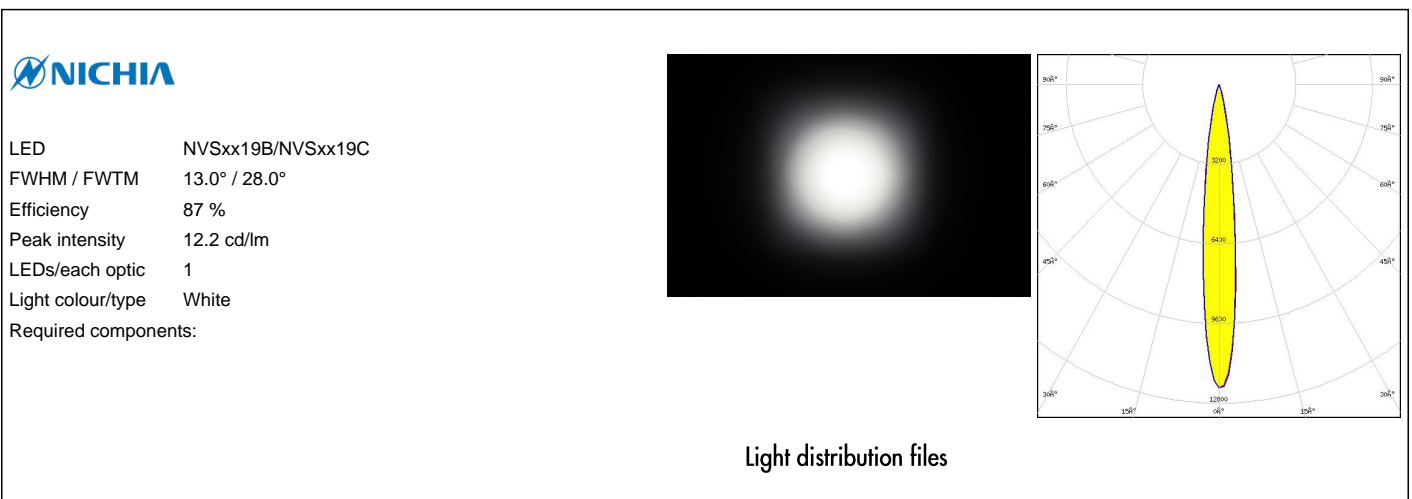
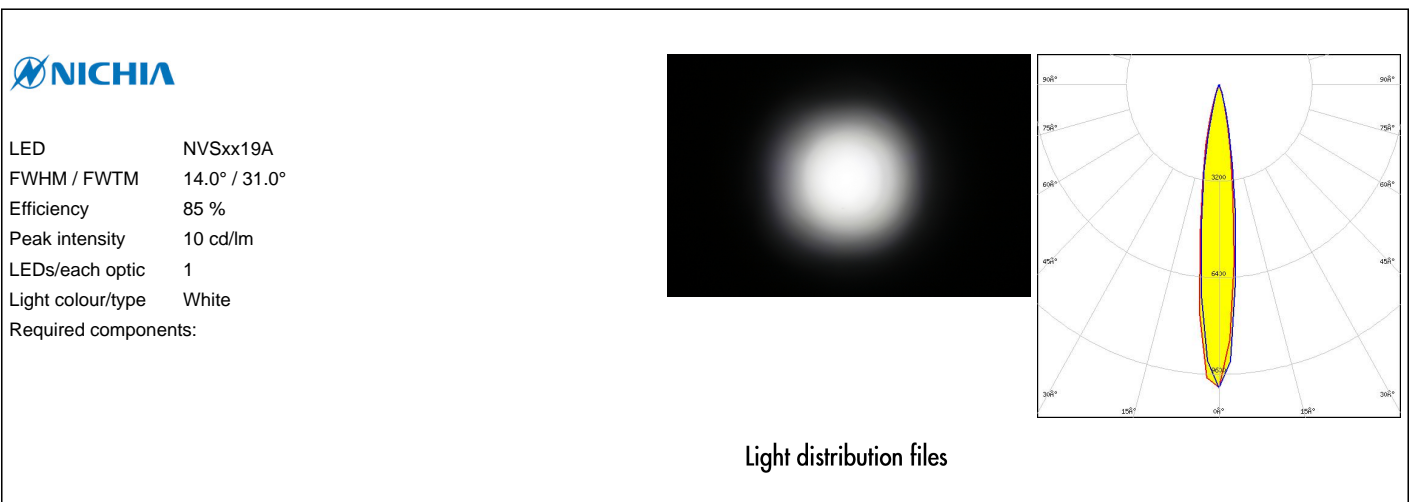
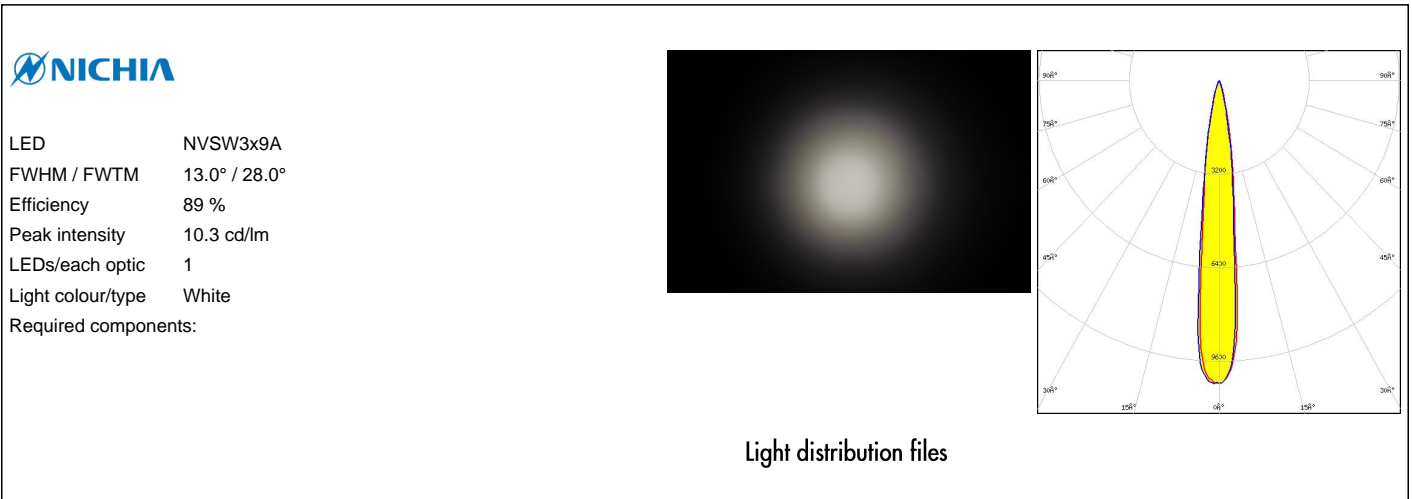

OPTICAL RESULTS (MEASURED):

SAMSUNG

LED LH351Z
 FWHM / FWTM 11.0° / 21.0°
 Efficiency 89 %
 Peak intensity 19.9 cd/lm
 LEDs/each optic 1
 Light colour/type White
 Required components:

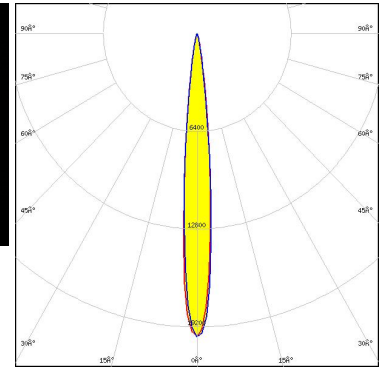

Light distribution files



LED Z8Y22P
 FWHM / FWTM 11.0° / 29.0°
 Efficiency 87 %
 Peak intensity 10.4 cd/lm
 LEDs/each optic 1
 Light colour/type White
 Required components:

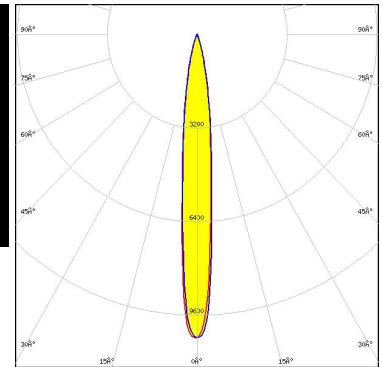
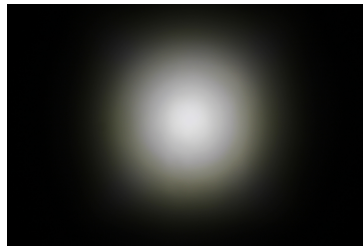

Light distribution files

OPTICAL RESULTS (SIMULATED):



LED XP-E2
FWHM / FWTM 9.0° / 19.0°
Efficiency 96 %
Peak intensity 25.7 cd/lm
LEDs/each optic 1
Light colour/type Amber
Required components:

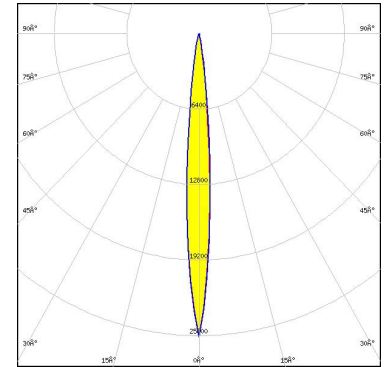

Light distribution files



LED XP-G2 HE
FWHM / FWTM 14.0° / 26.0°
Efficiency 97 %
Peak intensity 12.6 cd/lm
LEDs/each optic 1
Light colour/type White
Required components:

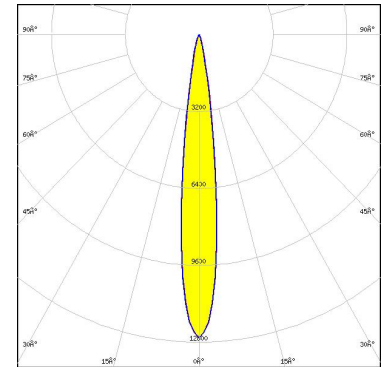

Light distribution files



LED XP-G4 HI
FWHM / FWTM 8.0° / 16.0°
Efficiency 95 %
Peak intensity 29 cd/lm
LEDs/each optic 1
Light colour/type White
Required components:

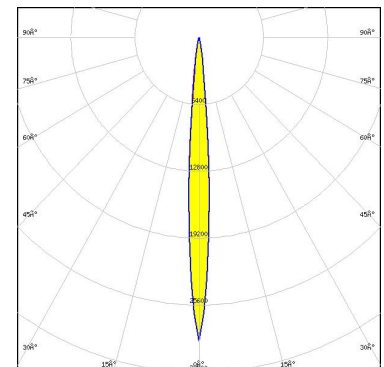

Light distribution files

OPTICAL RESULTS (SIMULATED):

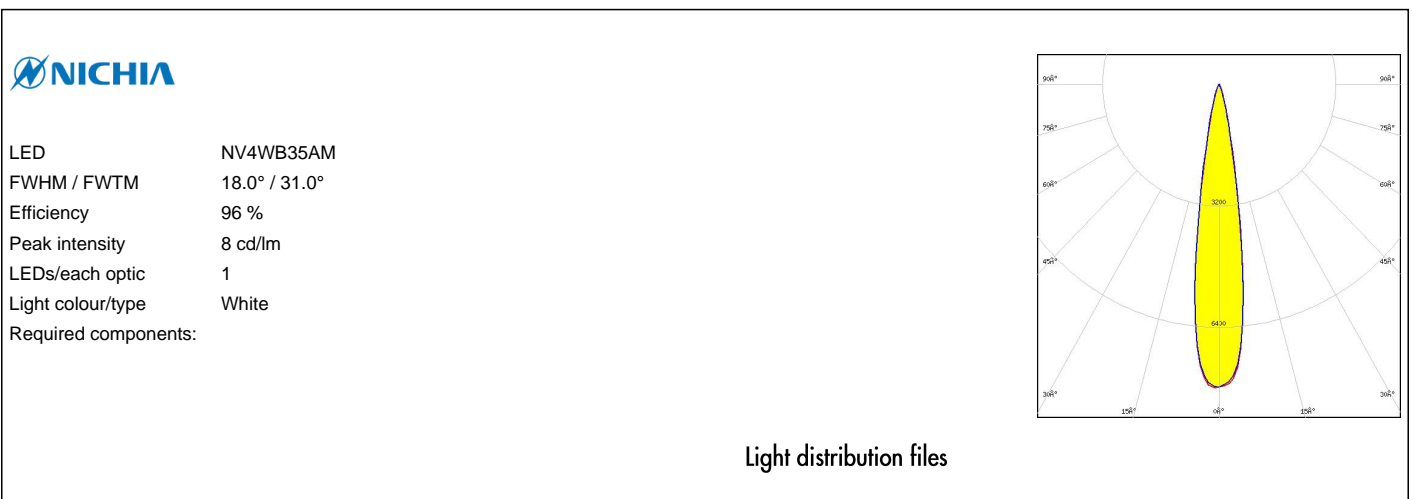
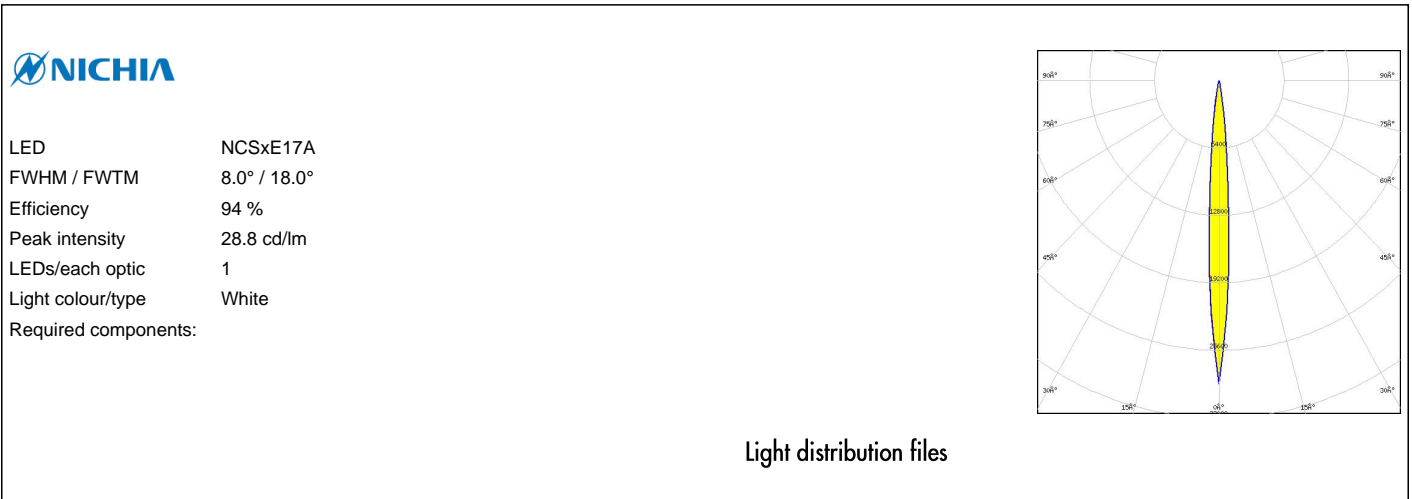

OPTICAL RESULTS (SIMULATED):

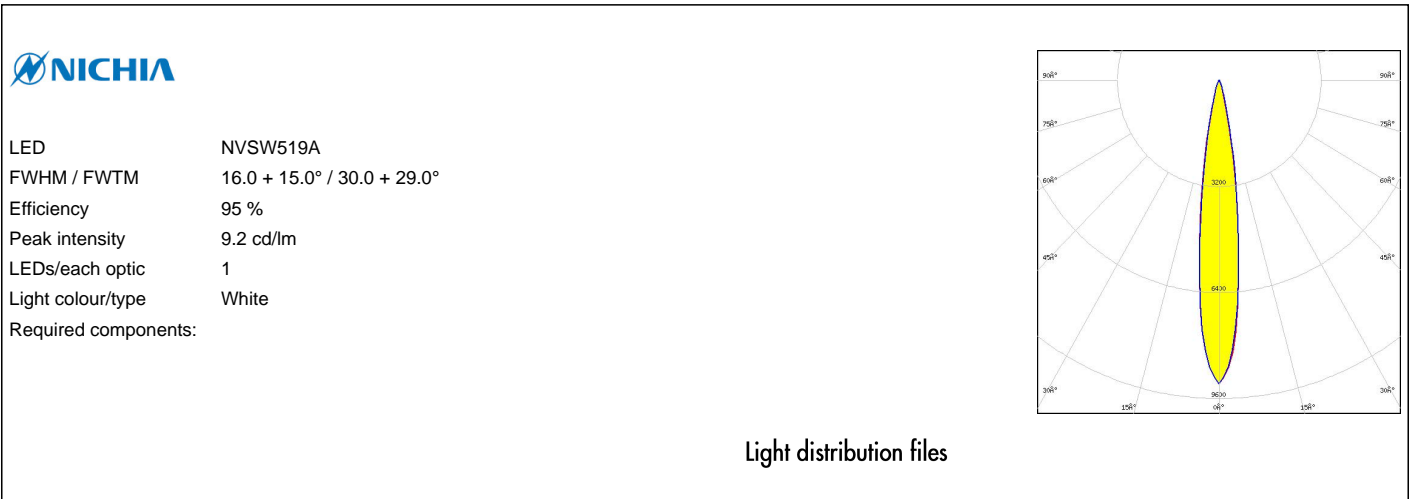

OPTICAL RESULTS (SIMULATED):

OSRAM
Opto Semiconductors

LED OSCONIQ P 3737 (3W version)
 FWHM / FWTM 15.0° / 28.0°
 Efficiency 94 %
 Peak intensity 10.5 cd/m
 LEDs/each optic 1
 Light colour/type White
 Required components:

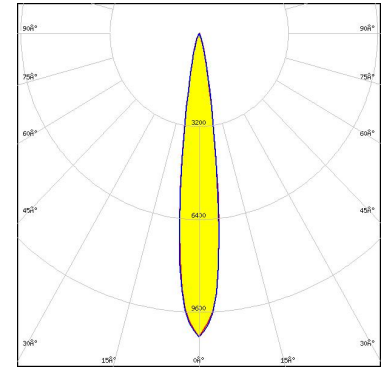

Light distribution files

OSRAM
Opto Semiconductors

LED OSLO Pure 1414
 FWHM / FWTM 6.0° / 14.0°
 Efficiency 96 %
 Peak intensity 47.8 cd/m
 LEDs/each optic 1
 Light colour/type White
 Required components:

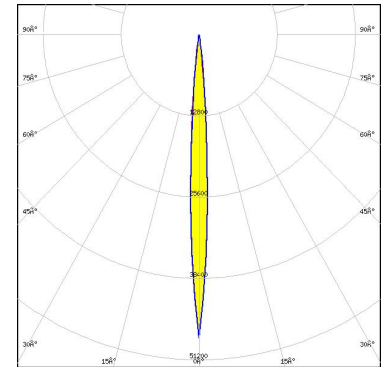

Light distribution files

OSRAM
Opto Semiconductors

LED OSLO Square CSSRM2/CSSRM3
 FWHM / FWTM 9.9° / 20.0°
 Efficiency 94 %
 Peak intensity 21.3 cd/m
 LEDs/each optic 1
 Light colour/type White
 Required components:

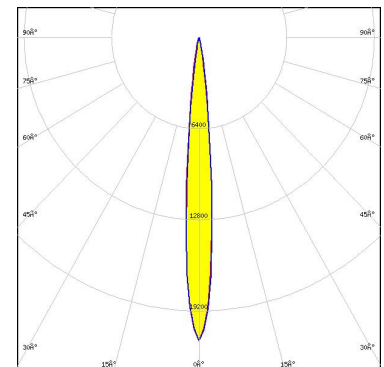

Light distribution files

OPTICAL RESULTS (SIMULATED):

SAMSUNG

LED LH351B
FWHM / FWTM 12.0°
Efficiency %
LEDs/each optic 1
Light colour/type White
Required components:

Light distribution files



LED MJT 3030
FWHM / FWTM 10.0° / 20.0°
Efficiency 96 %
Peak intensity 22.1 cd/lm
LEDs/each optic 1
Light colour/type White
Required components:

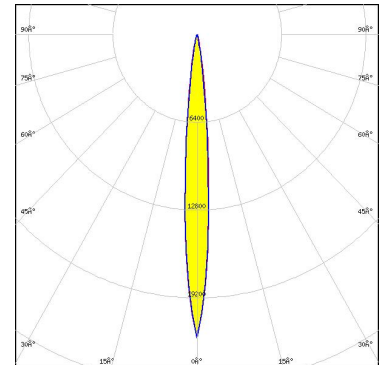

Light distribution files



LED Z5M4
FWHM / FWTM 14.0° / 26.0°
Efficiency 96 %
Peak intensity 12.9 cd/lm
LEDs/each optic 1
Light colour/type White
Required components:

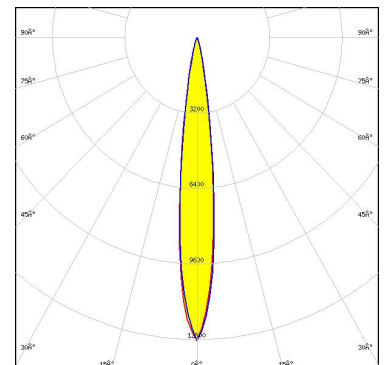

Light distribution files

OPTICAL RESULTS (SIMULATED):

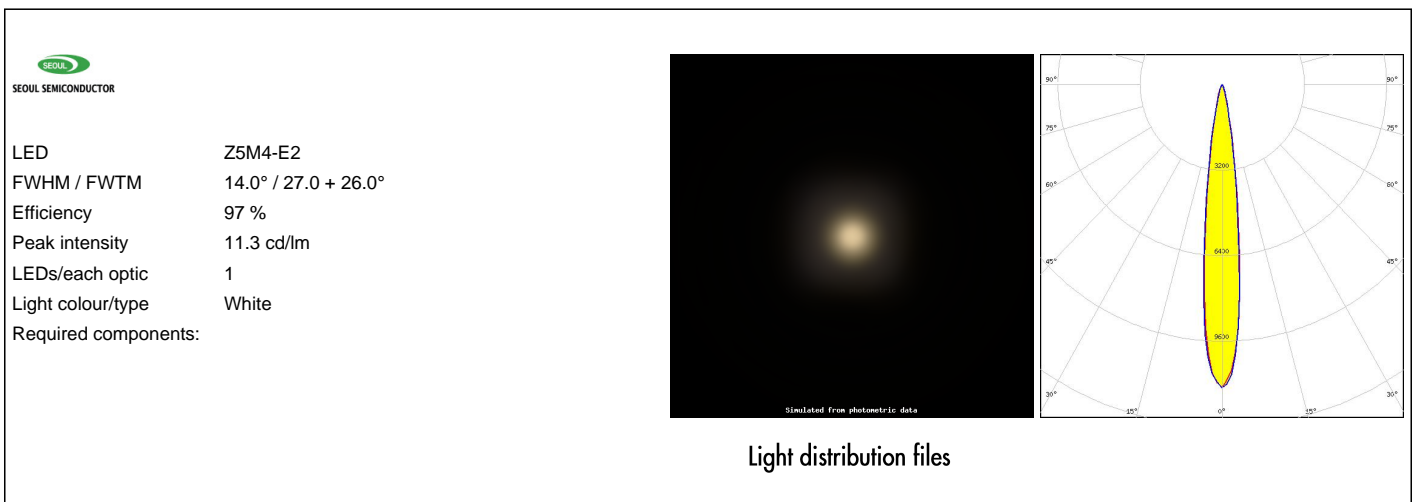
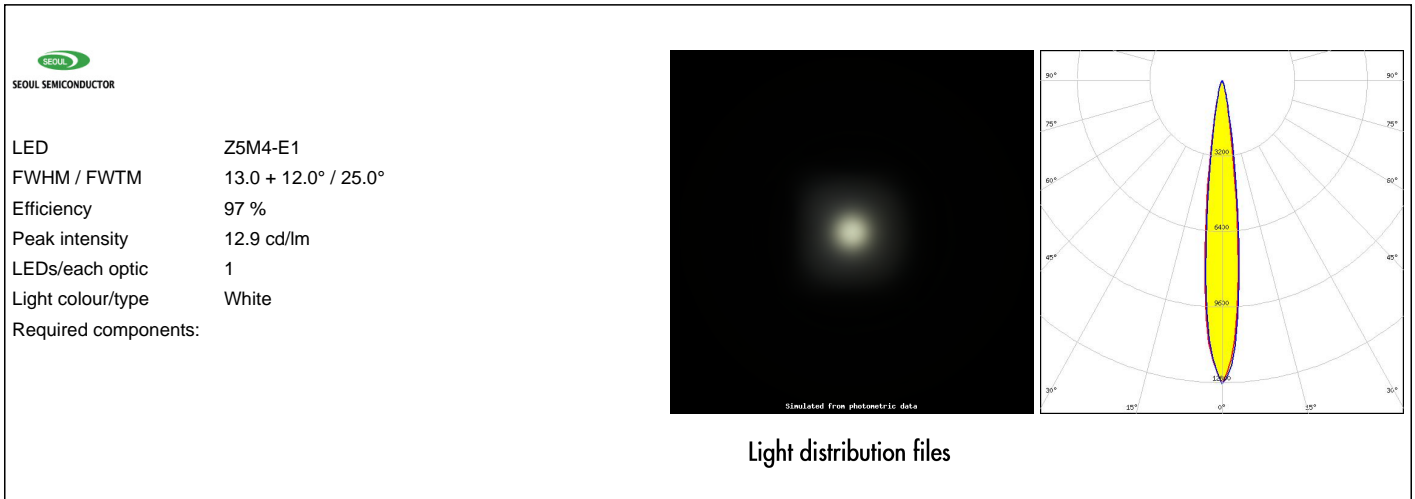

GENERAL INFORMATION:

NOTE: The typical beam angle will be changed by different color, chip size and chip position tolerance. The typical total beam angle is the full angle measured where the luminous intensity is half of the peak value.

MATERIALS:

As part of our continuous research and improvement processes, and to ensure the best possible quality and availability of our products, LEDiL reserves the right to change material grades without notice.

PRODUCT DATA USER AGREEMENT AND DISCLAIMER:

The measured data in the provided downloadable LEDiL Product Datasheets and Mechanical 2D-Drawings is rounded and provided as reference for planning. LEDiL Oy's optical specifications have been verified by conducting performance testing of the products in accordance with the company's quality system. The reported data are averaged results of multiple measurements with typical variation. LEDiL Oy reserves the right to without prior notification make changes and improvements to its products.

LEDiL Oy assumes neither warranty, nor guarantee nor any other liability of any kind for the contents and correctness of the provided data. The provided data has been generated with highest diligence but the provided data may in reality not represent the complete possible variation range of all intrinsic parameters. Therefore, in certain cases a deviation from the provided data could occur.

LEDiL Oy reserves the right to undertake technical changes of its products without further notification which could lead to changes in the provided data. LEDiL Oy assumes no liability of any kind for the possible deviation from any provided data or any other damage resulting from the usage of the provided data.

The user agrees to this disclaimer and user agreement with the download or usage of the provided files.

LEDiL Oy

Joensuunkatu 7
FI-24100 SALO
Finland

LEDiL Inc.

228 West Page Street
Suite D
Sycamore IL 60178
USA

Ledil Optics Technology (Shenzhen) Co., Ltd.

405 , Block B
Casic Motor Building
Shenzhen 518057
P.R.CHINA

Local sales and technical support

[www.ledil.com/
where_to_buy](http://www.ledil.com/where_to_buy)

Shipping locations

Poznan, Poland
Hong Kong, China

Distribution Partners

[www.ledil.com/
where_to_buy](http://www.ledil.com/where_to_buy)