

VERONICA-SQ-MINI-RS

~17° spot beam

SPECIFICATION:

Dimensions	13.9 x 13.9
Height	8.9 mm
Fastening	tape, pin
ROHS compliant	yes ⓘ

MATERIALS:

Component	Type	Material	Colour	Finish	Length (mm)
VERONICA-SQ-MINI-RS	Single lens	PMMA	clear		
VERONICA-SQ-MINI-TAPE	Tape	Acryl tape	clear		



ORDERING INFORMATION:

Component		Qty in box	MOQ	MPQ	Box weight (kg)
CA14601_VERONICA-SQ-MINI-RS	Single lens	5544	252	252	7.9
» Box size: 480 x 280 x 300 mm					

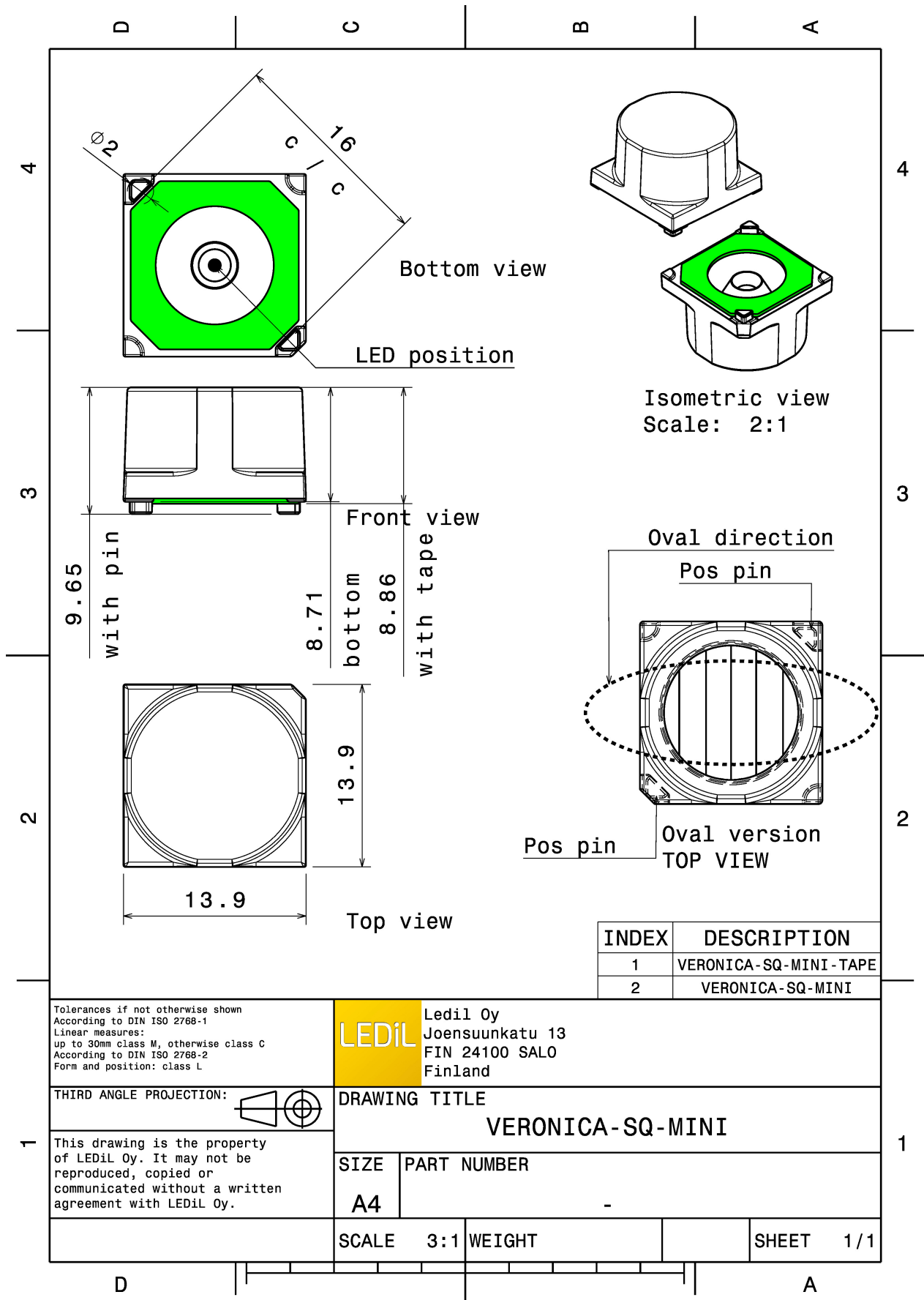

See also our general installation guide: www.ledil.com/installation_guide

OPTICAL RESULTS (MEASURED):



LED XD16
FWHM / FWTM 19.0° / 36.0°
Efficiency 92 %
Peak intensity 4.6 cd/lm
LEDs/each optic 1
Light colour/type White
Required components:

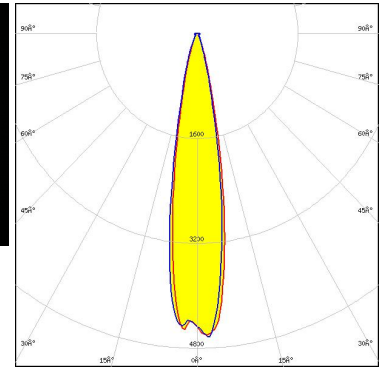

Light distribution files



LED XP-E2
FWHM / FWTM 14.0° / 26.0°
Efficiency 92 %
Peak intensity 11 cd/lm
LEDs/each optic 1
Light colour/type White
Required components:

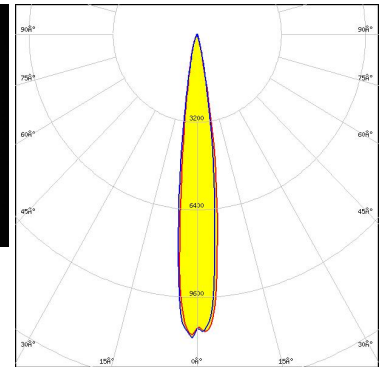

Light distribution files



LED XQ-E HI
FWHM / FWTM 9.4° / 24.0°
Efficiency 90 %
Peak intensity 14.7 cd/lm
LEDs/each optic 1
Light colour/type White
Required components:

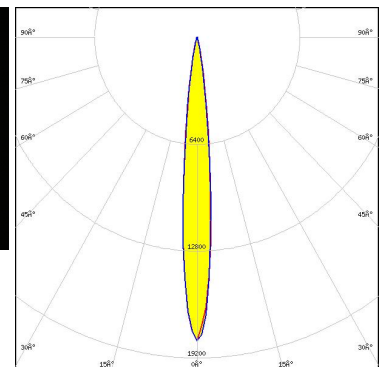

Light distribution files

OPTICAL RESULTS (MEASURED):



LED LUXEON Rebel ES
 FWHM / FWTM 21.0° / 43.0°
 Efficiency 83 %
 Peak intensity 4.3 cd/lm
 LEDs/each optic 1
 Light colour/type White
 Required components:

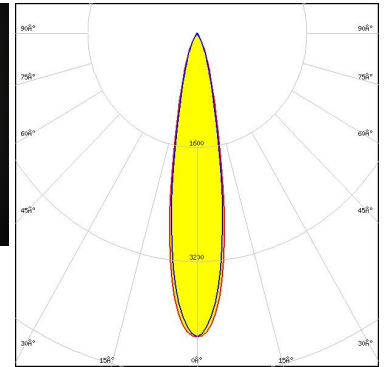
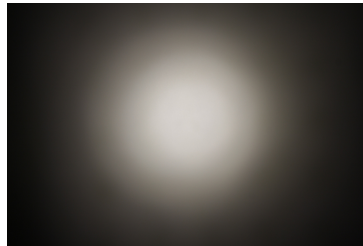

Light distribution files



LED LUXEON TX
 FWHM / FWTM 20.0° / 44.0°
 Efficiency 92 %
 Peak intensity 4 cd/lm
 LEDs/each optic 1
 Light colour/type White
 Required components:

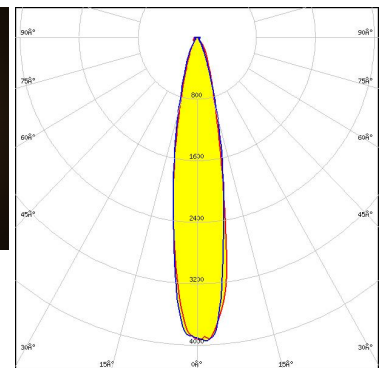
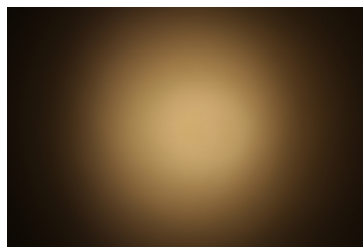

Light distribution files



LED NCSx17A
 FWHM / FWTM 11.0° / 32.0°
 Efficiency 92 %
 Peak intensity 7.6 cd/lm
 LEDs/each optic 1
 Light colour/type White
 Required components:

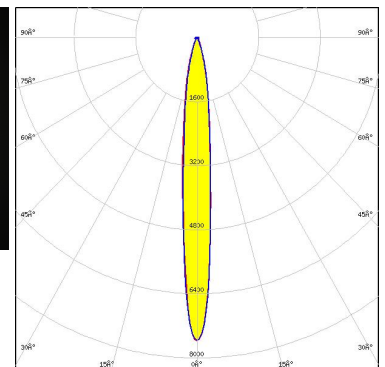
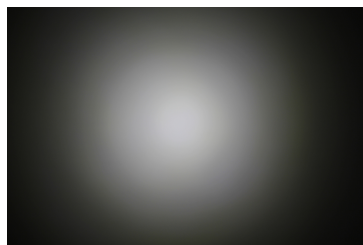

Light distribution files

OPTICAL RESULTS (MEASURED):



LED NVSxx19B/NVSxx19C
 FWHM / FWTM 21.0° / 45.0°
 Efficiency 93 %
 Peak intensity 3.8 cd/lm
 LEDs/each optic 1
 Light colour/type White
 Required components:

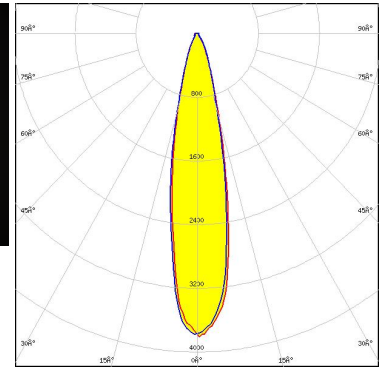

Light distribution files



LED OSLOM Square EC
 FWHM / FWTM 18.0° / 37.0°
 Efficiency 91 %
 Peak intensity 5.3 cd/lm
 LEDs/each optic 1
 Light colour/type White
 Required components:

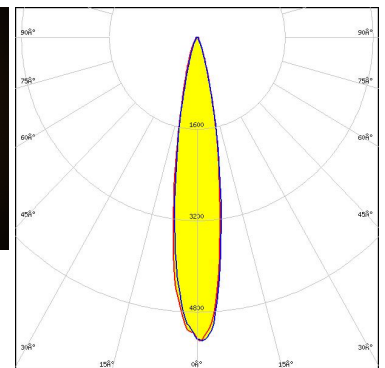
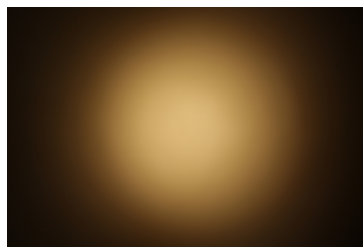

Light distribution files



LED SFH 4170S
 FWHM / FWTM 13.0° / 25.0°
 Efficiency %
 LEDs/each optic 1
 Light colour/type IR
 Required components:

Light distribution files

OPTICAL RESULTS (MEASURED):

OSRAM
Opto Semiconductors

LED SFH 4180S
FWHM / FWTM 11.0° / 22.0°
Efficiency %
LEDs/each optic 1
Light colour/type IR
Required components:

Light distribution files

SAMSUNG

LED LH181A
FWHM / FWTM 21.0° / 44.0°
Efficiency 86 %
Peak intensity 3 cd/lm
LEDs/each optic 1
Light colour/type White
Required components:

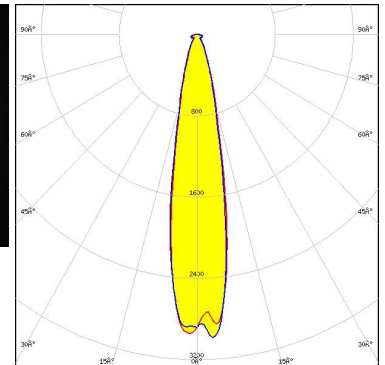

Light distribution files

SAMSUNG

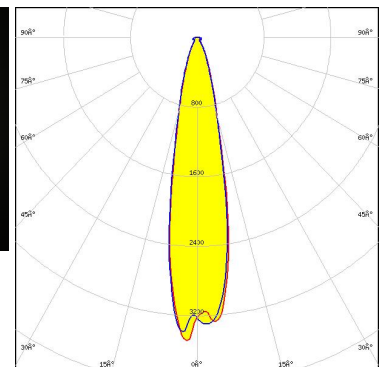
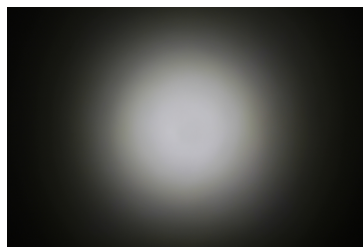

LED LH181B
FWHM / FWTM 22.0° / 45.0°
Efficiency 94 %
Peak intensity 3.5 cd/lm
LEDs/each optic 1
Light colour/type White
Required components:



Light distribution files

OPTICAL RESULTS (MEASURED):

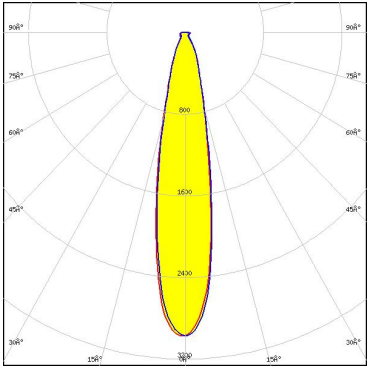
 SEOL SEMICONDUCTOR		
LED	Z8Y22P	
FWHM / FWTM	21.0° / 49.0°	
Efficiency	92 %	
Peak intensity	3 cd/lm	
LEDs/each optic	1	
Light colour/type	White	
Required components:		



Light distribution files

OPTICAL RESULTS (SIMULATED):



LED XP-E
 FWHM / FWTM 15.0° / 29.0°
 Efficiency 92 %
 Peak intensity 10.3 cd/lm
 LEDs/each optic 1
 Light colour/type White
 Required components:

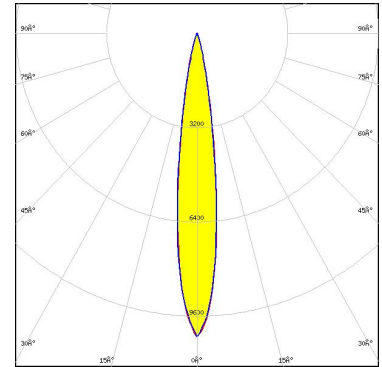

Light distribution files



LED XP-G
 FWHM / FWTM 21.0° / 40.0°
 Efficiency 91 %
 Peak intensity 5.2 cd/lm
 LEDs/each optic 1
 Light colour/type White
 Required components:

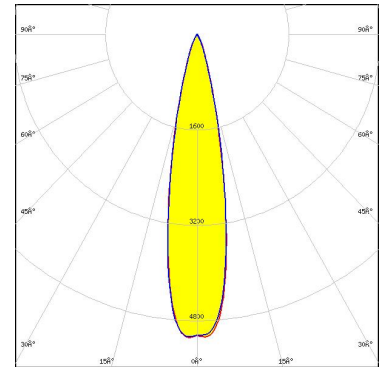

Light distribution files



LED XP-G2
 FWHM / FWTM 20.0° / 38.0°
 Efficiency 93 %
 Peak intensity 6 cd/lm
 LEDs/each optic 1
 Light colour/type White
 Required components:

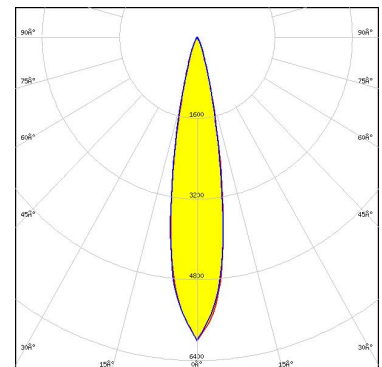

Light distribution files

OPTICAL RESULTS (SIMULATED):



LED XP-G2 HE
FWHM / FWTM 24.0° / 47.0°
Efficiency 97 %
Peak intensity 3.5 cd/lm
LEDs/each optic 1
Light colour/type White
Required components:

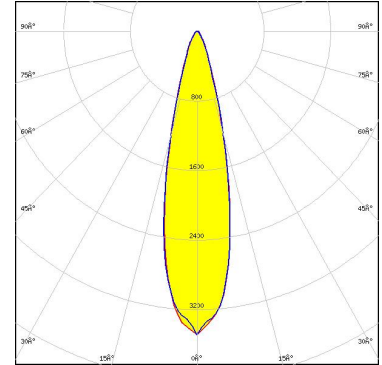

Light distribution files



LED XP-G4
FWHM / FWTM 22.0° / 40.0°
Efficiency 96 %
Peak intensity 4.6 cd/lm
LEDs/each optic 1
Light colour/type White
Required components:

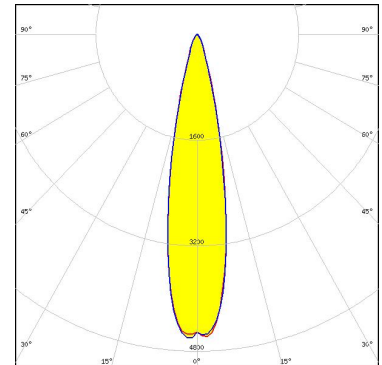

Light distribution files



LED XQ-E HD
FWHM / FWTM 13.0° / 28.0°
Efficiency 89 %
Peak intensity 11 cd/lm
LEDs/each optic 1
Light colour/type White
Required components:

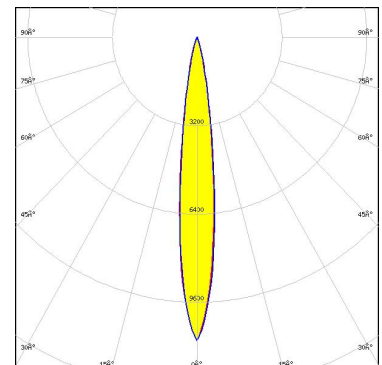

Light distribution files

OPTICAL RESULTS (SIMULATED):



LED LUXEON 2835 Line
FWHM / FWTM 12.0° / 29.0°
Efficiency 96 %
Peak intensity 10 cd/lm
LEDs/each optic 1
Light colour/type PC Amber
Required components:

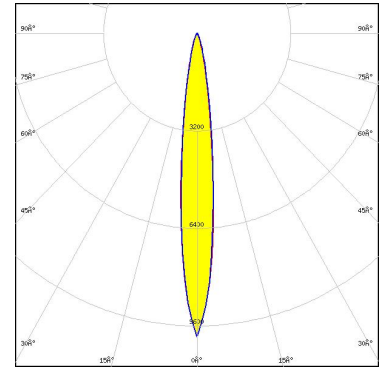

Light distribution files



LED LUXEON 3030 2D (Round LES)
FWHM / FWTM 16.0° / 40.0°
Efficiency 95 %
Peak intensity 5.6 cd/lm
LEDs/each optic 1
Light colour/type White
Required components:

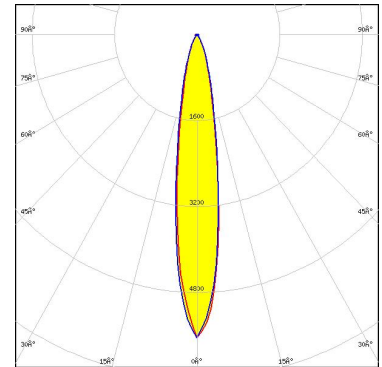

Light distribution files



LED LUXEON 3030 HV
FWHM / FWTM 17.0° / 41.0°
Efficiency 95 %
Peak intensity 5.5 cd/lm
LEDs/each optic 1
Light colour/type White
Required components:

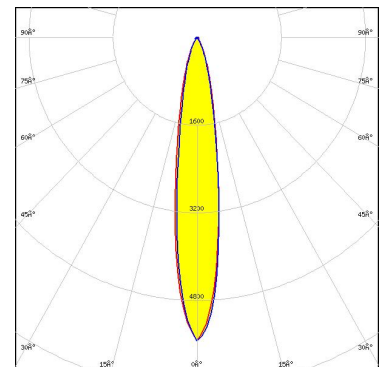

Light distribution files

OPTICAL RESULTS (SIMULATED):



LED LUXEON A
 FWHM / FWTM 21.0° / 42.0°
 Efficiency 89 %
 Peak intensity 4.5 cd/lm
 LEDs/each optic 1
 Light colour/type White
 Required components:

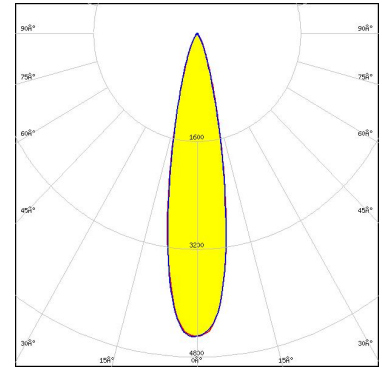

Light distribution files



LED LUXEON C
 FWHM / FWTM 15.0° / 31.0°
 Efficiency 94 %
 Peak intensity 9.9 cd/lm
 LEDs/each optic 1
 Light colour/type White
 Required components:

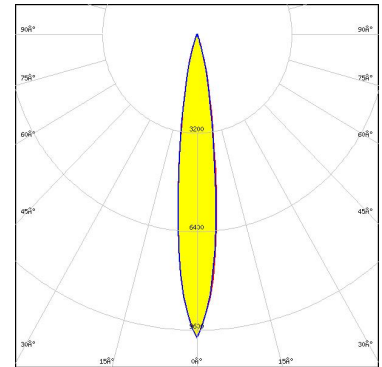

Light distribution files



LED LUXEON HL1Z
 FWHM / FWTM 12.0° / 30.0°
 Efficiency 96 %
 Peak intensity 10.2 cd/lm
 LEDs/each optic 1
 Light colour/type White
 Required components:

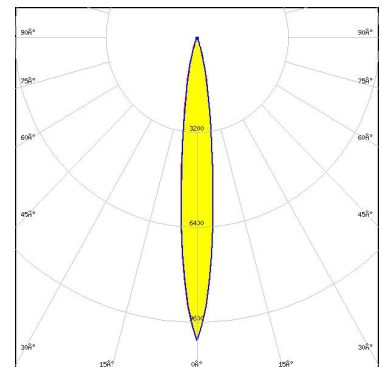

Light distribution files

OPTICAL RESULTS (SIMULATED):



LED LUXEON Rebel
 FWHM / FWTM 16.0° / 34.0°
 Efficiency 87 %
 Peak intensity 7.5 cd/lm
 LEDs/each optic 1
 Light colour/type White
 Required components:

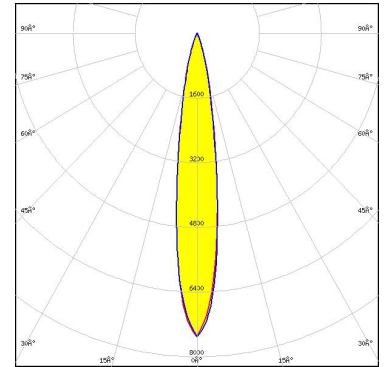

Light distribution files



LED LUXEON T
 FWHM / FWTM 22.0° / 42.0°
 Efficiency 96 %
 Peak intensity 4.7 cd/lm
 LEDs/each optic 1
 Light colour/type White
 Required components:

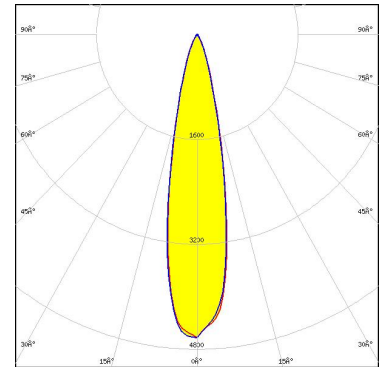

Light distribution files



LED LUXEON Z ES
 FWHM / FWTM 14.0° / 31.0°
 Efficiency 89 %
 Peak intensity 9.5 cd/lm
 LEDs/each optic 1
 Light colour/type White
 Required components:

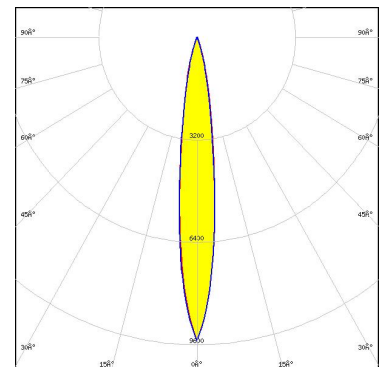

Light distribution files

OPTICAL RESULTS (SIMULATED):



LED SST-20 Gen1
FWHM / FWTM 17.0° / 37.0°
Efficiency 96 %
Peak intensity 6.2 cd/lm
LEDs/each optic 1
Light colour/type White
Required components:

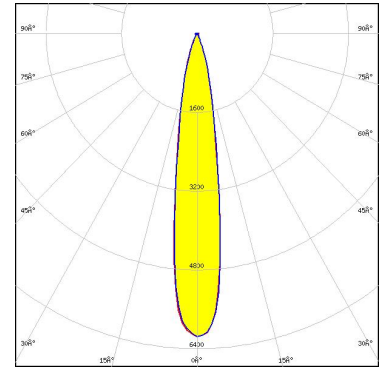

Light distribution files



LED NF2x757G
FWHM / FWTM 19.0° / 40.0°
Efficiency 97 %
Peak intensity 5.5 cd/lm
LEDs/each optic 1
Light colour/type White
Required components:

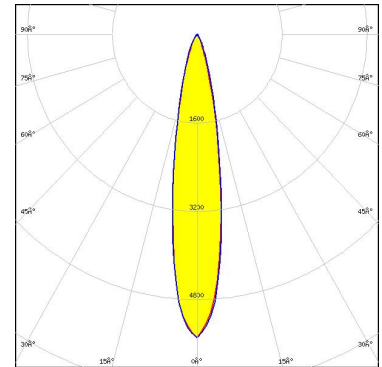

Light distribution files



LED NFSx757G
FWHM / FWTM 14.0° / 33.0°
Efficiency 96 %
Peak intensity 7.8 cd/lm
LEDs/each optic 1
Light colour/type White
Required components:

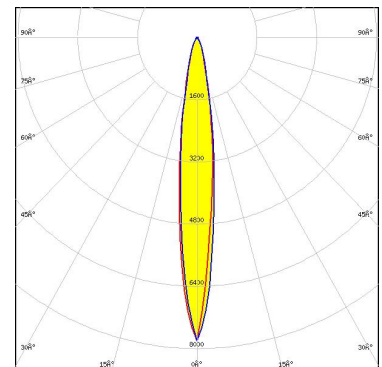

Light distribution files

OPTICAL RESULTS (SIMULATED):



LED NV4WB35AM
 FWHM / FWTM 28.0° / 68.0°
 Efficiency 95 %
 Peak intensity 2.1 cd/lm
 LEDs/each optic 1
 Light colour/type White
 Required components:

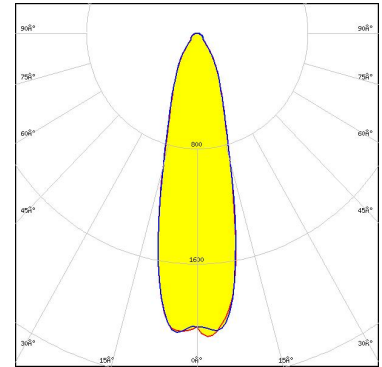

Light distribution files



LED NVSxE21A
 FWHM / FWTM 15.0° / 41.0°
 Efficiency 94 %
 Peak intensity 5.3 cd/lm
 LEDs/each optic 1
 Light colour/type White
 Required components:

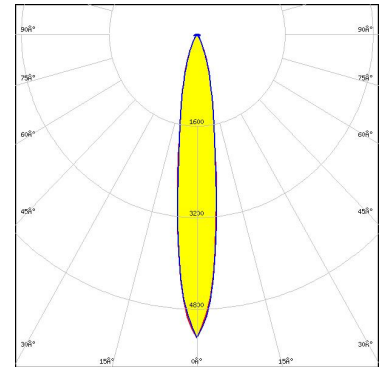

Light distribution files



LED NVSxx19B/NVSxx19C
 FWHM / FWTM 24.0° / 47.0°
 Efficiency 94 %
 Peak intensity 3.8 cd/lm
 LEDs/each optic 1
 Light colour/type White
 Required components:

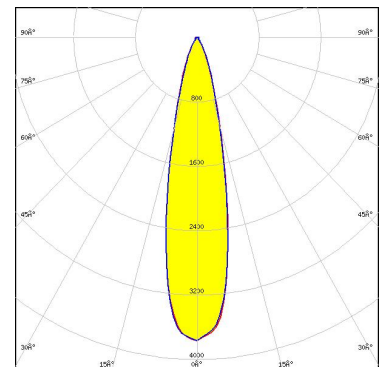

Light distribution files

OPTICAL RESULTS (SIMULATED):

OSRAM
Opto Semiconductors

LED OSCONIQ P 3737 (2W version)
 FWHM / FWTM 18.0° / 39.0°
 Efficiency 94 %
 Peak intensity 5.8 cd/lm
 LEDs/each optic 1
 Light colour/type White
 Required components:

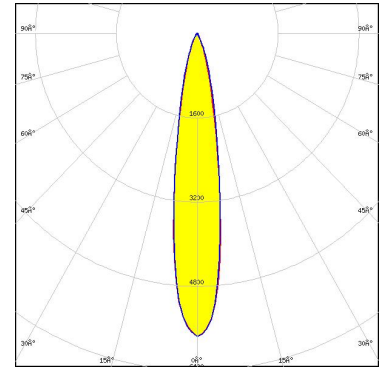

Light distribution files

OSRAM
Opto Semiconductors

LED OSCONIQ P 3737 (3W version)
 FWHM / FWTM 25.0° / 43.0°
 Efficiency 89 %
 Peak intensity 2.6 cd/lm
 LEDs/each optic 1
 Light colour/type White
 Required components:

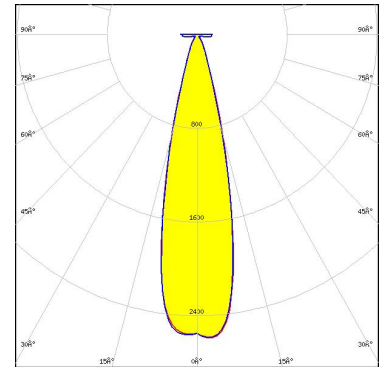

Light distribution files

OSRAM
Opto Semiconductors

LED OSLO Pure 1414
 FWHM / FWTM 12.0° / 24.0°
 Efficiency 97 %
 Peak intensity 15.6 cd/lm
 LEDs/each optic 1
 Light colour/type White
 Required components:

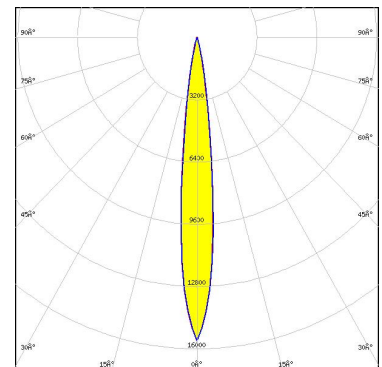

Light distribution files

OPTICAL RESULTS (SIMULATED):

OSRAM
Opto Semiconductors

LED OSLON Square CSSRM2/CSSRM3
FWHM / FWTM 18.0° / 39.0°
Efficiency 92 %
Peak intensity 5.9 cd/lm
LEDs/each optic 1
Light colour/type White
Required components:

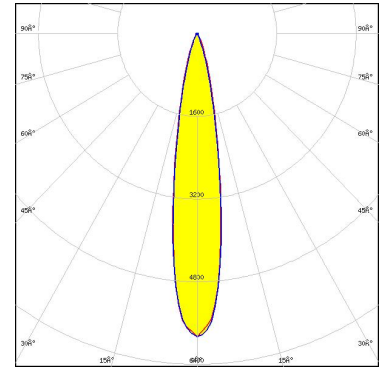

Light distribution files

OSRAM
Opto Semiconductors

LED OSLON SSL 150
FWHM / FWTM 14.0° / 28.0°
Efficiency 89 %
Peak intensity 10.7 cd/lm
LEDs/each optic 1
Light colour/type White
Required components:

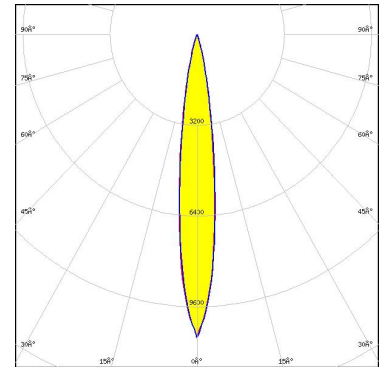

Light distribution files

OSRAM
Opto Semiconductors

LED OSLON SSL 80
FWHM / FWTM 14.0° / 29.0°
Efficiency 90 %
Peak intensity 10.2 cd/lm
LEDs/each optic 1
Light colour/type White
Required components:

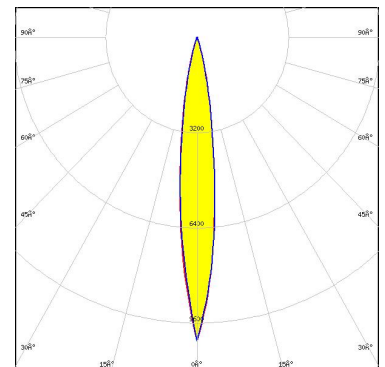

Light distribution files

OPTICAL RESULTS (SIMULATED):

SAMSUNG

LED LH351B
 FWHM / FWTM 24.0° / 46.0°
 Efficiency 94 %
 Peak intensity 3.9 cd/lm
 LEDs/each optic 1
 Light colour/type White
 Required components:

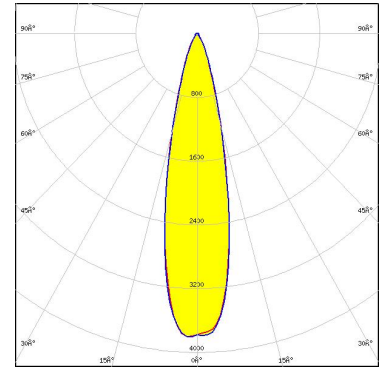

Light distribution files

SAMSUNG

LED LH351Z
 FWHM / FWTM 19.0° / 36.0°
 Efficiency 92 %
 Peak intensity 6.1 cd/lm
 LEDs/each optic 1
 Light colour/type White
 Required components:

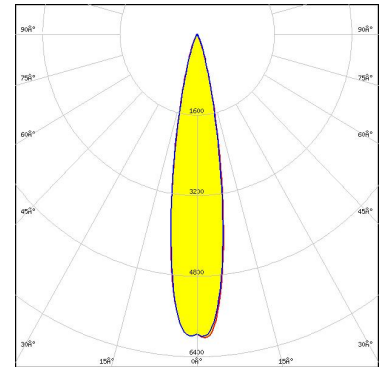

Light distribution files



LED MJT 3030
 FWHM / FWTM 16.0° / 38.0°
 Efficiency 96 %
 Peak intensity 6.1 cd/lm
 LEDs/each optic 1
 Light colour/type White
 Required components:

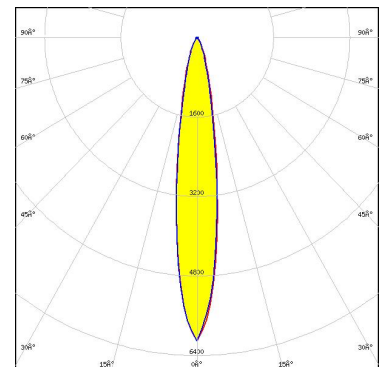

Light distribution files

OPTICAL RESULTS (SIMULATED):

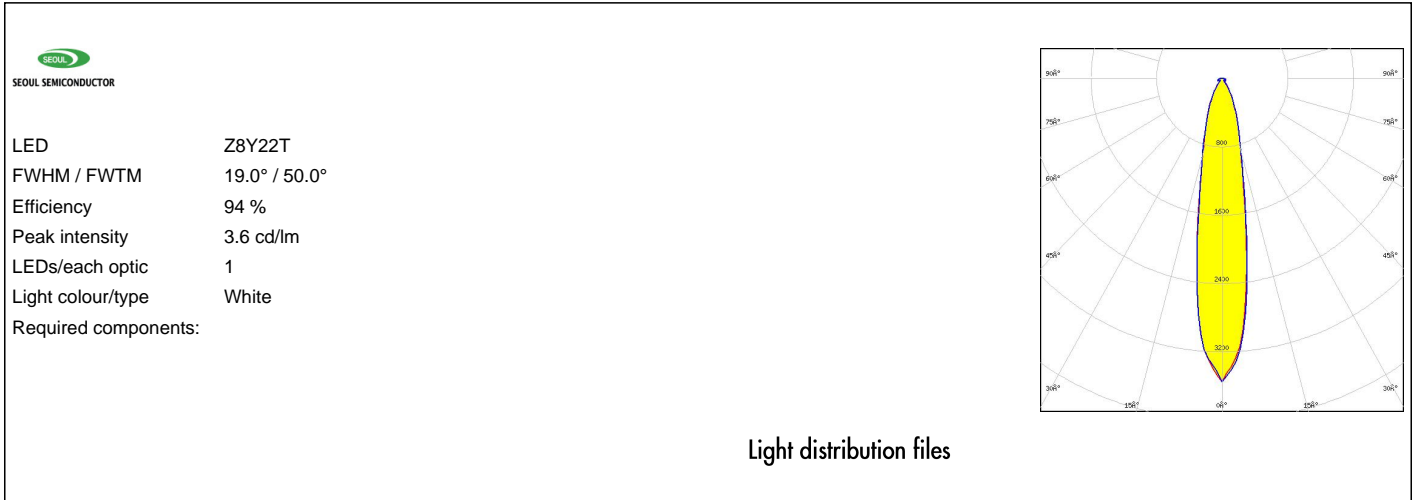

GENERAL INFORMATION:

NOTE: The typical beam angle will be changed by different color, chip size and chip position tolerance. The typical total beam angle is the full angle measured where the luminous intensity is half of the peak value.

MATERIALS:

As part of our continuous research and improvement processes, and to ensure the best possible quality and availability of our products, LEDiL reserves the right to change material grades without notice.

PRODUCT DATA USER AGREEMENT AND DISCLAIMER:

The measured data in the provided downloadable LEDiL Product Datasheets and Mechanical 2D-Drawings is rounded and provided as reference for planning. LEDiL Oy's optical specifications have been verified by conducting performance testing of the products in accordance with the company's quality system. The reported data are averaged results of multiple measurements with typical variation. LEDiL Oy reserves the right to without prior notification make changes and improvements to its products.

LEDiL Oy assumes neither warranty, nor guarantee nor any other liability of any kind for the contents and correctness of the provided data. The provided data has been generated with highest diligence but the provided data may in reality not represent the complete possible variation range of all intrinsic parameters. Therefore, in certain cases a deviation from the provided data could occur.

LEDiL Oy reserves the right to undertake technical changes of its products without further notification which could lead to changes in the provided data. LEDiL Oy assumes no liability of any kind for the possible deviation from any provided data or any other damage resulting from the usage of the provided data.

The user agrees to this disclaimer and user agreement with the download or usage of the provided files.

LEDiL Oy

Joensuunkatu 7
FI-24100 SALO
Finland

LEDiL Inc.

228 West Page Street
Suite D
Sycamore IL 60178
USA

Ledil Optics Technology (Shenzhen) Co., Ltd.

405 , Block B
Casic Motor Building
Shenzhen 518057
P.R.CHINA

Local sales and technical support

[www.ledil.com/
where_to_buy](http://www.ledil.com/where_to_buy)

Shipping locations

Poznan, Poland
Hong Kong, China

Distribution Partners

[www.ledil.com/
where_to_buy](http://www.ledil.com/where_to_buy)