

Strada-A-XP-G LENSES FOR CREE XP-G LEDs



- Specially designed for Cree XP-G series of LEDs.
- New extremely wide street light design, vertically wider version coming soon.
- With the result of an extremely creative design lens itself tilts automatically light 4 degrees.
- Special care taken to make a uniform white or warm white illumination.
- Lens material optical grade PMMA with high UV and temperature resistance (105°C/220°F). Allows use of high current and temperature conditions.
- Best available optical efficiency, approximately 94%.
- Fastening to heat sink with or without PU foam adhesive tape of automotive grade, please select which suits the best for your needs.
- We advise customer to ensure the suitability and sufficiency of the bond in the end product. For example, mechanical stress, vibration and holes on the surface of the circuit board weaken the strength of the tape.
- Please check fastening details from this link:
(http://www.ledil.com/datasheets/DataSheet_TAPE.pdf)

LENS TYPES

NAME	ORDERING CODE	FWHM Angle
Strada-A-XP-G	C10818_Strada-A-XP-G	H=±72°, ±37° V=±22°
Strada-A-XP-G-TAPE	CA10823_Strada-A-XP-G-tape	H=±72°, ±37° V=±22°



© Ledil Oy – PRELIMINARY - Subject to change without prior notice

MEASUREMENT DATA

Relative Intensity of C10818_Strada-A-XP

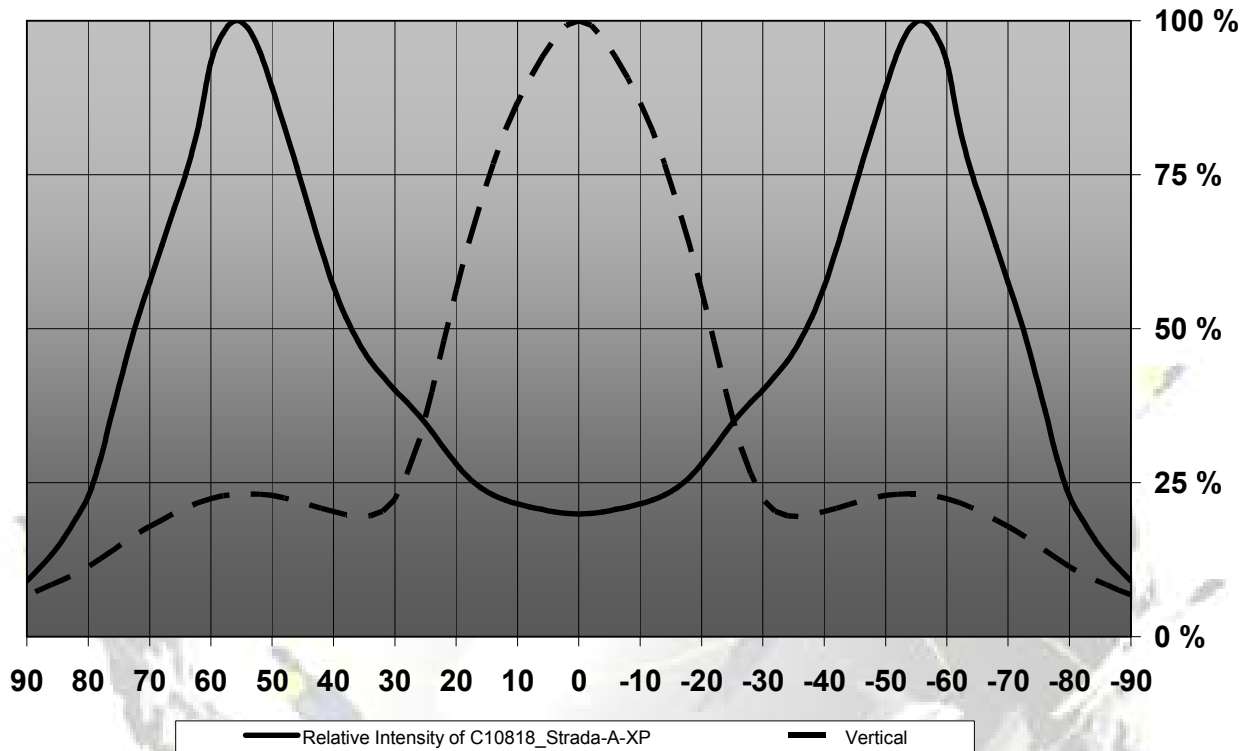

© Ledil Oy – PRELIMINARY - Subject to change without prior notice

Example configuration (not optimized)

Strada-A-XP-G

Pole distance: 15m / and single
 Height above the street: 6m
 Position of the lamp from the side of the road: 2.2m
 Tilt angle of the lamp: 10

100x Cree XP's per lamp
 55lm 0.8W (3.2V/250mA)

Length: 0.7m
 Width: 0.3m
 Rows: 5
 LED's per row: 20

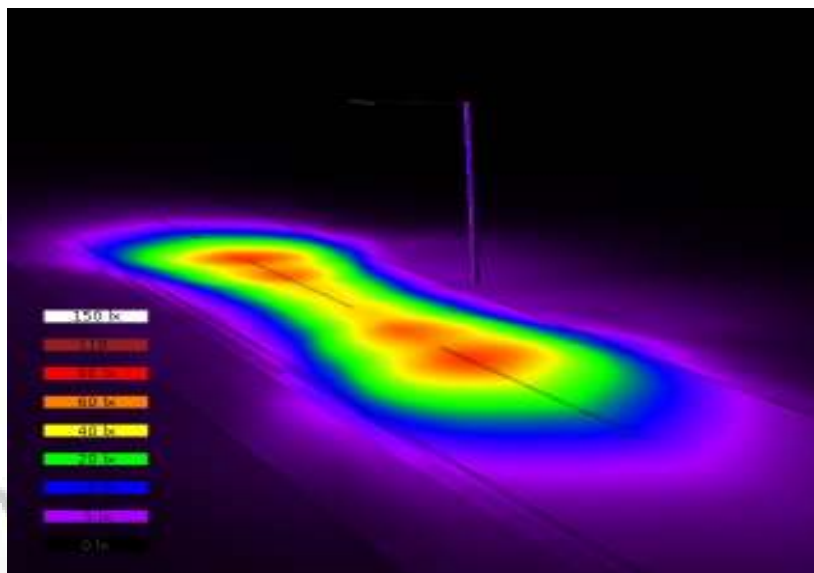

DRAWINGS

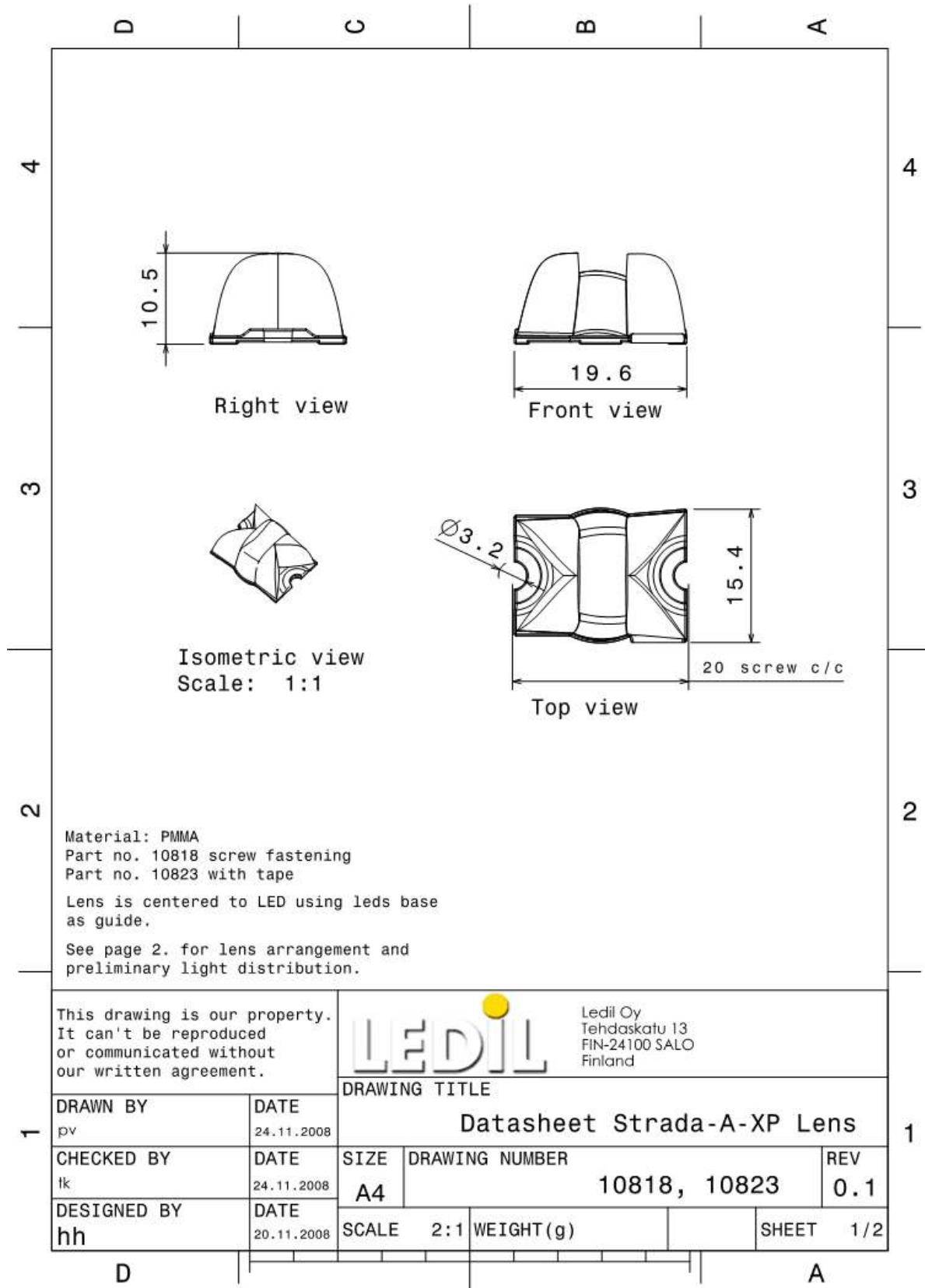

© Ledil Oy - PRELIMINARY - Subject to change without prior notice

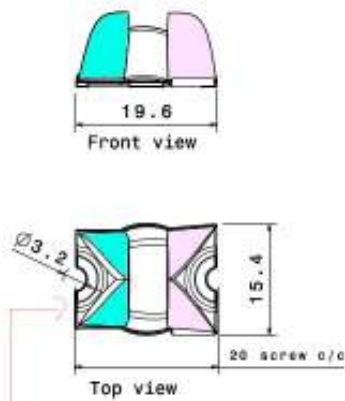

to tilt the light correctly to street,
put the narrower side against the
end side of the street

put the narrower side against the
end side of the street

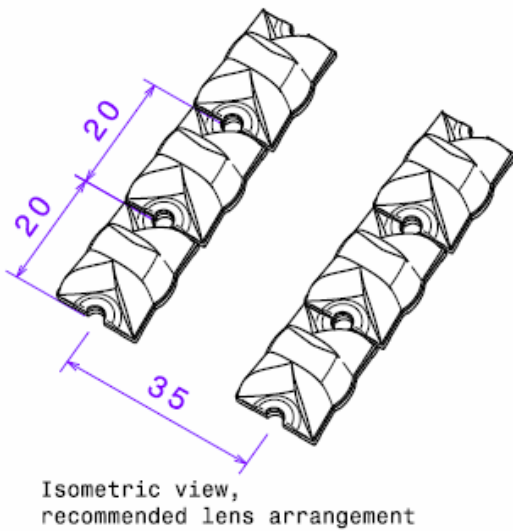
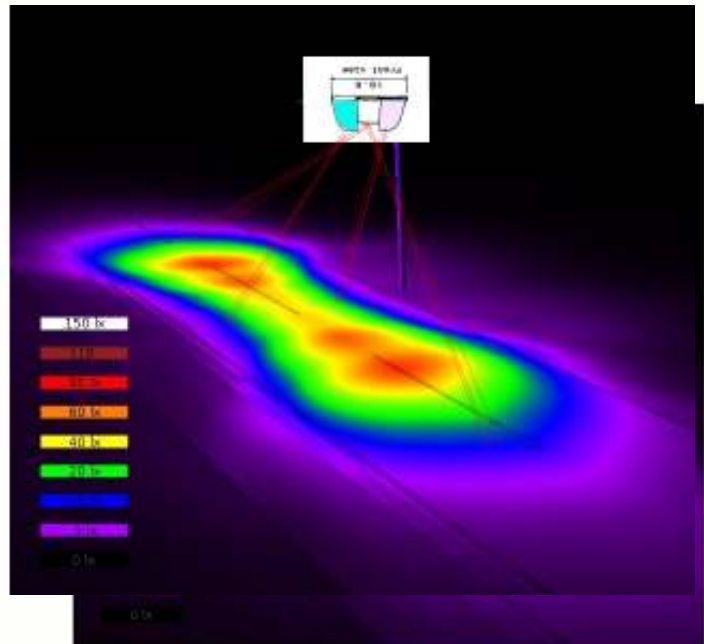

Isometric view,
recommended lens arrangement

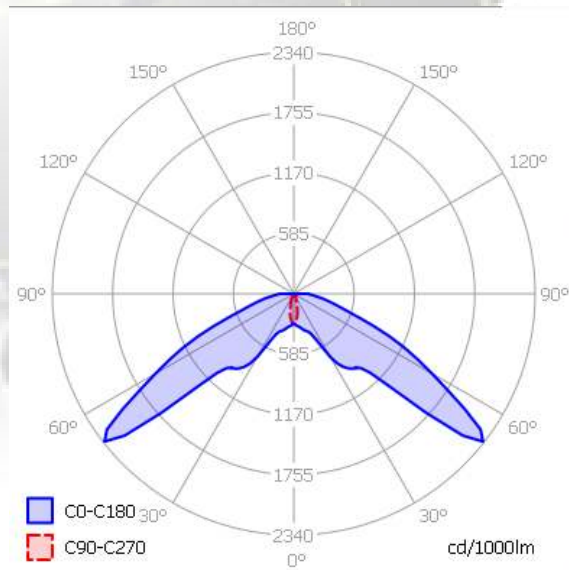

EULUMDAT & IES FILES AVAILABLE BY REQUEST