

## ALISE-50-S

~15° spot beam

### SPECIFICATION:

Dimensions	Ø 49.9
Height	25 mm
ROHS compliant	yes ⓘ



### MATERIALS:

Component	Type	Material	Colour	Finish	Coating
ALISE-50-S	Reflector	Aluminium	metal		Anodized

### ORDERING INFORMATION:

Component	Qty in box	MOQ	MPQ	Box weight (kg)
C16907_ALISE-50-S » Box size: 370 x 320 x 210 mm	750	100	25	5.8

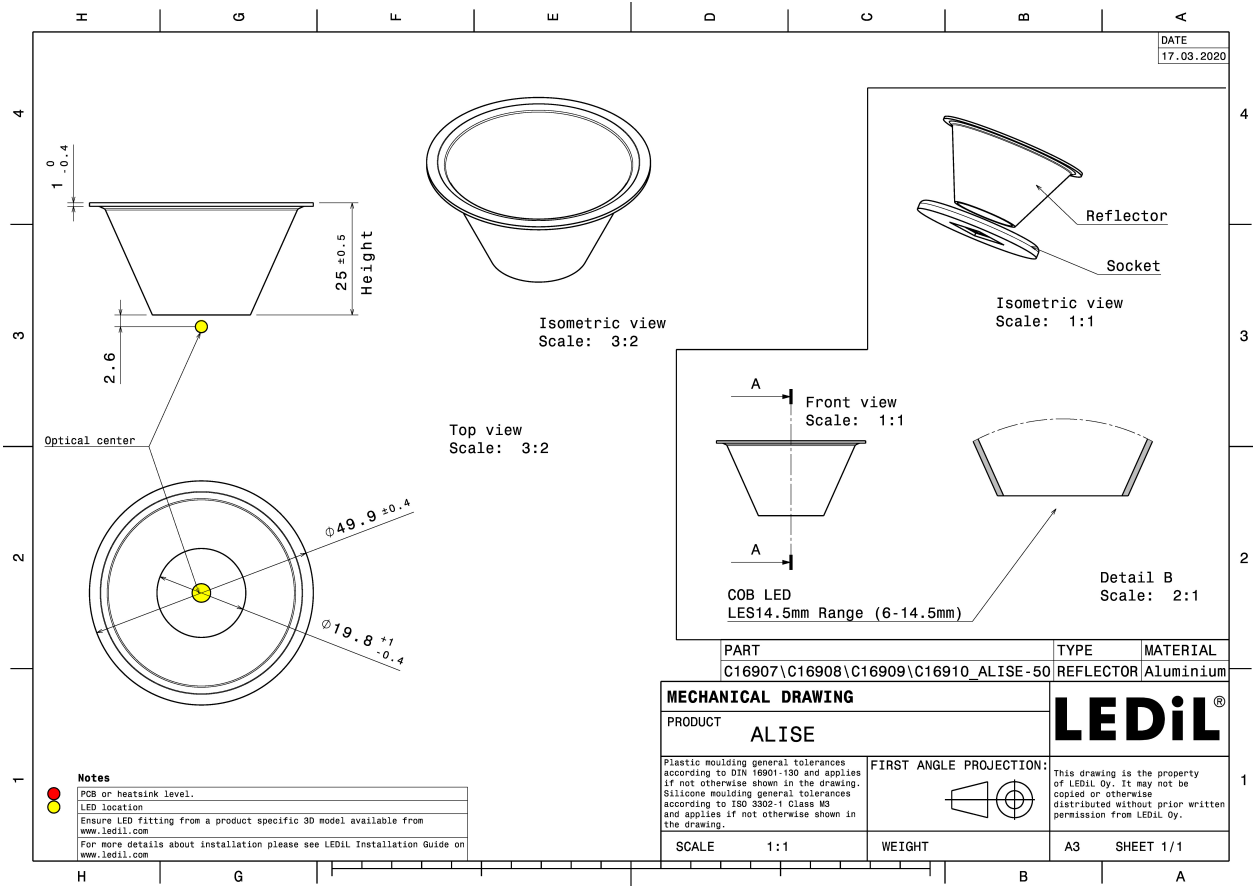

See also our general installation guide: [www.ledil.com/installation\\_guide](http://www.ledil.com/installation_guide)

#### OPTICAL RESULTS (MEASURED):

**OSRAM**  
Opto Semiconductors

LED OSLON UV 3535 (SU CULFP1.VC)  
FWHM / FWTM 12.0° / 63.0°  
Efficiency 69 %  
LEDs/each optic 1  
Light colour/type UV-C

Required components:

The UVC LED result tolerance is  $\pm 10\%$

[Light distribution files](#)

[LDC linear pdf](#)

**STANLEY**

LED ZEUBE265 Series  
FWHM / FWTM 9.0° / 46.0°  
Efficiency 70 %  
LEDs/each optic 1  
Light colour/type UV-C

Required components:

The UVC LED result tolerance is  $\pm 10\%$

[Light distribution files](#)

[LDC linear pdf](#)

#### OPTICAL RESULTS (SIMULATED):



LED: Vero SE 10  
 FWHM / FWTM: 18.0° / 50.0°  
 Efficiency: 87 %  
 Peak intensity: 4.2 cd/lm  
 LEDs/each optic: 1  
 Light colour/type: White  
 Required components:

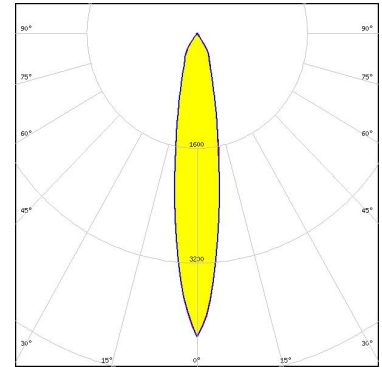

Light distribution files

#### CITIZEN

LED: CLL02x/CLU02x (LES10)  
 FWHM / FWTM: 22.0° / 60.0°  
 Efficiency: 73 %  
 Peak intensity: 2.5 cd/lm  
 LEDs/each optic: 1  
 Light colour/type: White  
 Required components:  
 C17099\_ALISE-50-DL

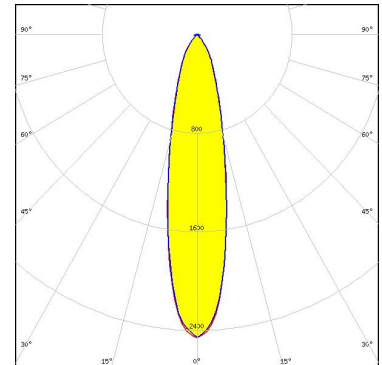

Light distribution files



LED: CMT14xx  
 FWHM / FWTM: 10.0° / 52.0°  
 Efficiency: 90 %  
 Peak intensity: 3.9 cd/lm  
 LEDs/each optic: 1  
 Light colour/type: White  
 Required components:

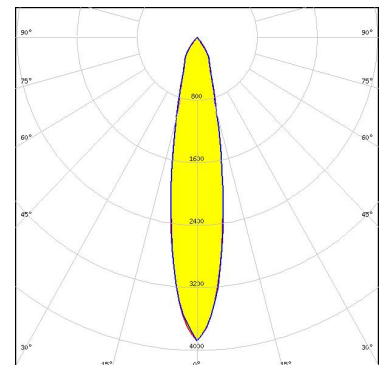

Light distribution files

### OPTICAL RESULTS (SIMULATED):



LED LUXEON CoB 1202/1203  
 FWHM / FWTM 21.0° / 49.0°  
 Efficiency 97 %  
 Peak intensity 4.1 cd/lm  
 LEDs/each optic 1  
 Light colour/type White  
 Required components:

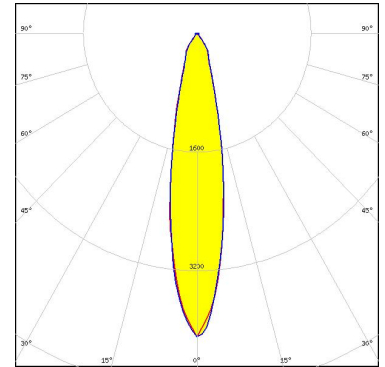

Light distribution files



LED LUXEON CoB 1202s  
 FWHM / FWTM 19.0° / 42.0°  
 Efficiency 91 %  
 Peak intensity 4.7 cd/lm  
 LEDs/each optic 1  
 Light colour/type White  
 Required components:

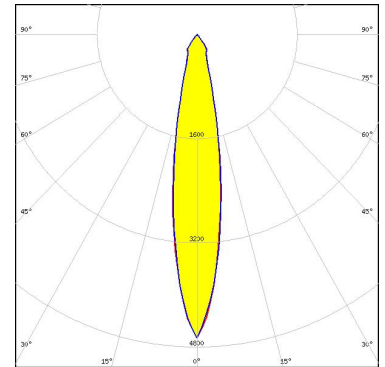

Light distribution files



LED LUXEON CoB Compact  
 FWHM / FWTM 19.0° / 43.0°  
 Efficiency 91 %  
 Peak intensity 4.8 cd/lm  
 LEDs/each optic 1  
 Light colour/type White  
 Required components:

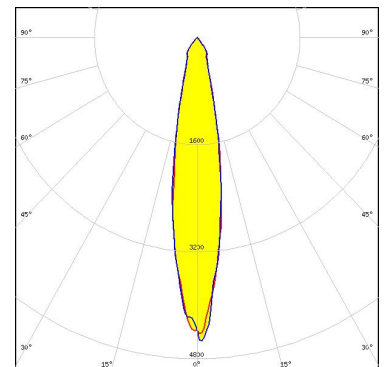

Light distribution files

### OPTICAL RESULTS (SIMULATED):



LED: XFM-5050 4 Die  
 FWHM / FWTM: 16.0° / 32.0°  
 Efficiency: 90 %  
 LEDs/each optic: 1  
 Light colour/type: UV-C  
 Required components:

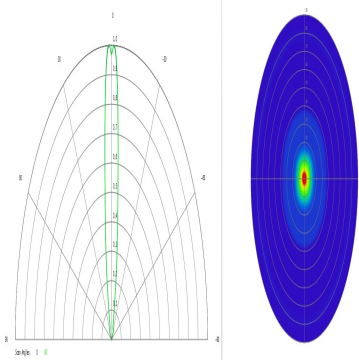

Light distribution files

The UVC LED result tolerance is ±10 %



LED: WICOP DY9560-27  
 FWHM / FWTM: 21.0° / 44.0°  
 Efficiency: 90 %  
 LEDs/each optic: 24  
 Light colour/type: UV-C  
 Required components:

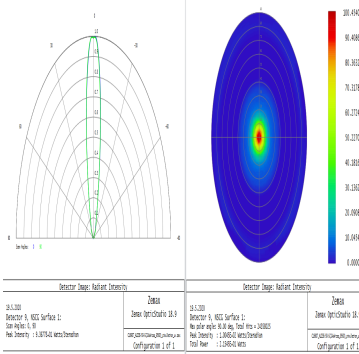

Light distribution files

The UVC LED result tolerance is ±10 %



LED: ZEUBE265 Series  
 FWHM / FWTM: 11.0° / 29.0°  
 Efficiency: 90 %  
 LEDs/each optic: 1  
 Light colour/type: UV-C  
 Required components:



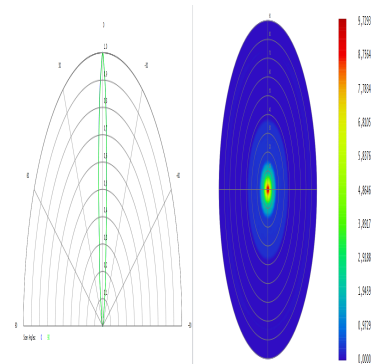

Light distribution files

### GENERAL INFORMATION:

NOTE: The typical beam angle will be changed by different color, chip size and chip position tolerance. The typical total beam angle is the full angle measured where the luminous intensity is half of the peak value.

Due to use of high power COB's with this product, special attention to proper thermal design is highly recommended. LEDiL has no liability for direct, indirect or consecutive damages arising from the LEDiL products being used outside of the recommended temperature range.

### MATERIALS:

As part of our continuous research and improvement processes, and to ensure the best possible quality and availability of our products, LEDiL reserves the right to change material grades without notice.

### PRODUCT DATA USER AGREEMENT AND DISCLAIMER:

The measured data in the provided downloadable LEDiL Product Datasheets and Mechanical 2D-Drawings is rounded and provided as reference for planning. LEDiL Oy's optical specifications have been verified by conducting performance testing of the products in accordance with the company's quality system. The reported data are averaged results of multiple measurements with typical variation. LEDiL Oy reserves the right to without prior notification make changes and improvements to its products.

LEDiL Oy assumes neither warranty, nor guarantee nor any other liability of any kind for the contents and correctness of the provided data. The provided data has been generated with highest diligence but the provided data may in reality not represent the complete possible variation range of all intrinsic parameters. Therefore, in certain cases a deviation from the provided data could occur.

LEDiL Oy reserves the right to undertake technical changes of its products without further notification which could lead to changes in the provided data. LEDiL Oy assumes no liability of any kind for the possible deviation from any provided data or any other damage resulting from the usage of the provided data.

The user agrees to this disclaimer and user agreement with the download or usage of the provided files.

#### LEDiL Oy

Joensuunkatu 7  
FI-24240 SALO  
Finland

#### LEDiL Inc.

228 West Page Street  
Suite D  
Sycamore IL 60178  
USA

#### Ledil Optics Technology (Shenzhen) Co., Ltd.

# 405 , Block B  
Casic Motor Building  
Shenzhen 518057  
P.R.CHINA

#### Local sales and technical support

[www.ledil.com/  
where\\_to\\_buy](http://www.ledil.com/where_to_buy)

#### Shipping locations

Poznan, Poland  
Hong Kong, China

#### Distribution Partners

[www.ledil.com/  
where\\_to\\_buy](http://www.ledil.com/where_to_buy)