

AMY-70-WW

~60° wide beam

SPECIFICATION:

Dimensions	Ø 69.9 mm
Height	12.8 mm
Fastening	socket
ROHS compliant	yes ⓘ

MATERIALS:

Component	Type	Material	Colour	Finish
AMY-70-WW	Single lens	PMMA		
AMY-70-HLD2-C	Holder C	PC	black	
AMY-70-HLD2-B	Holder B	PC	black	
AMY-70-HLD2-C-WHT	Holder C	PC	white	
AMY-70-HLD2-B-WHT	Holder B	PC	white	



ORDERING INFORMATION:

Component	Qty in box	MOQ	MPQ	Box weight (kg)
C17779_AMY-70-WW	285	285	15	7.4
Assembly				
CP19118_AMY-70-WW-B2-WHT	210	210	15	7.2
CP19114_AMY-70-WW-C2-WHT	210	210	15	7.0
CP19103_AMY-70-WW-B2	210	210	15	7.2
CP19040_AMY-70-WW-C2	210	210	15	7.0

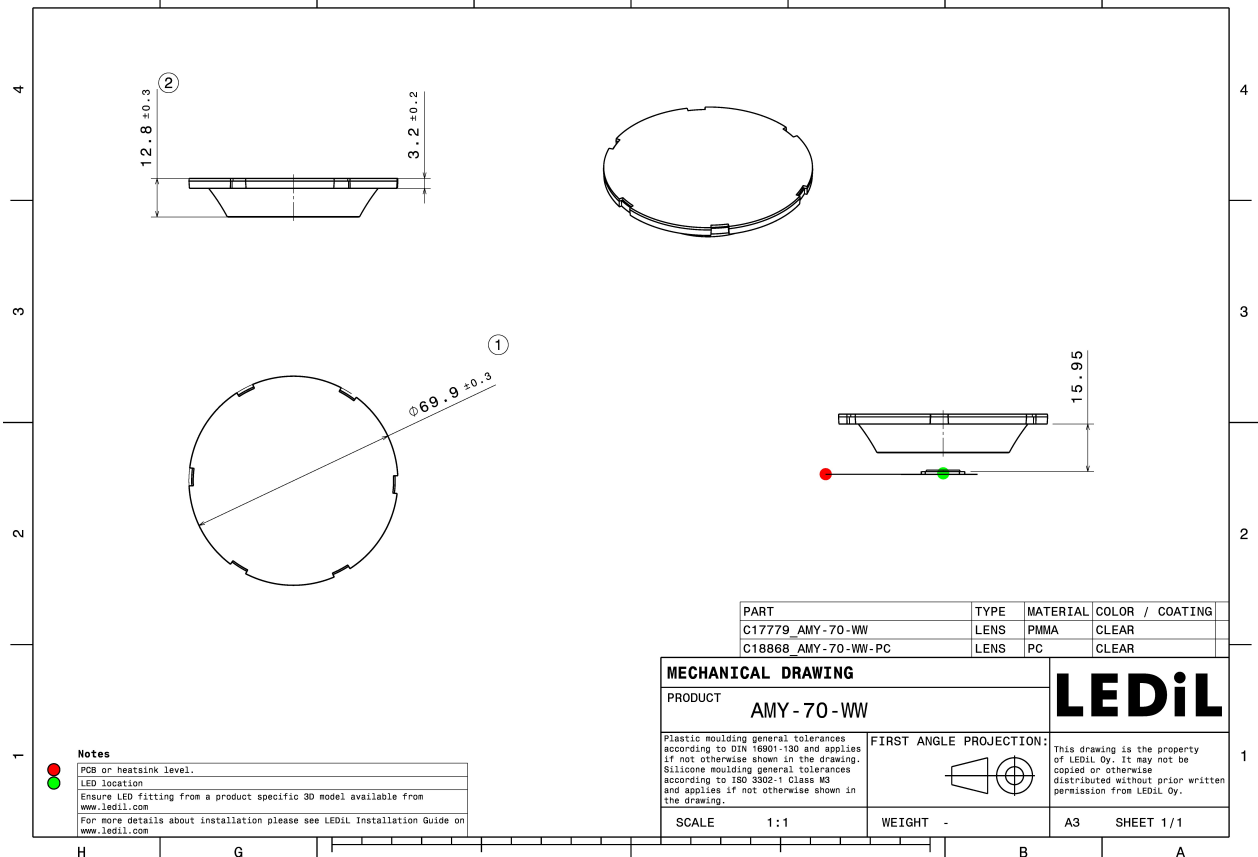
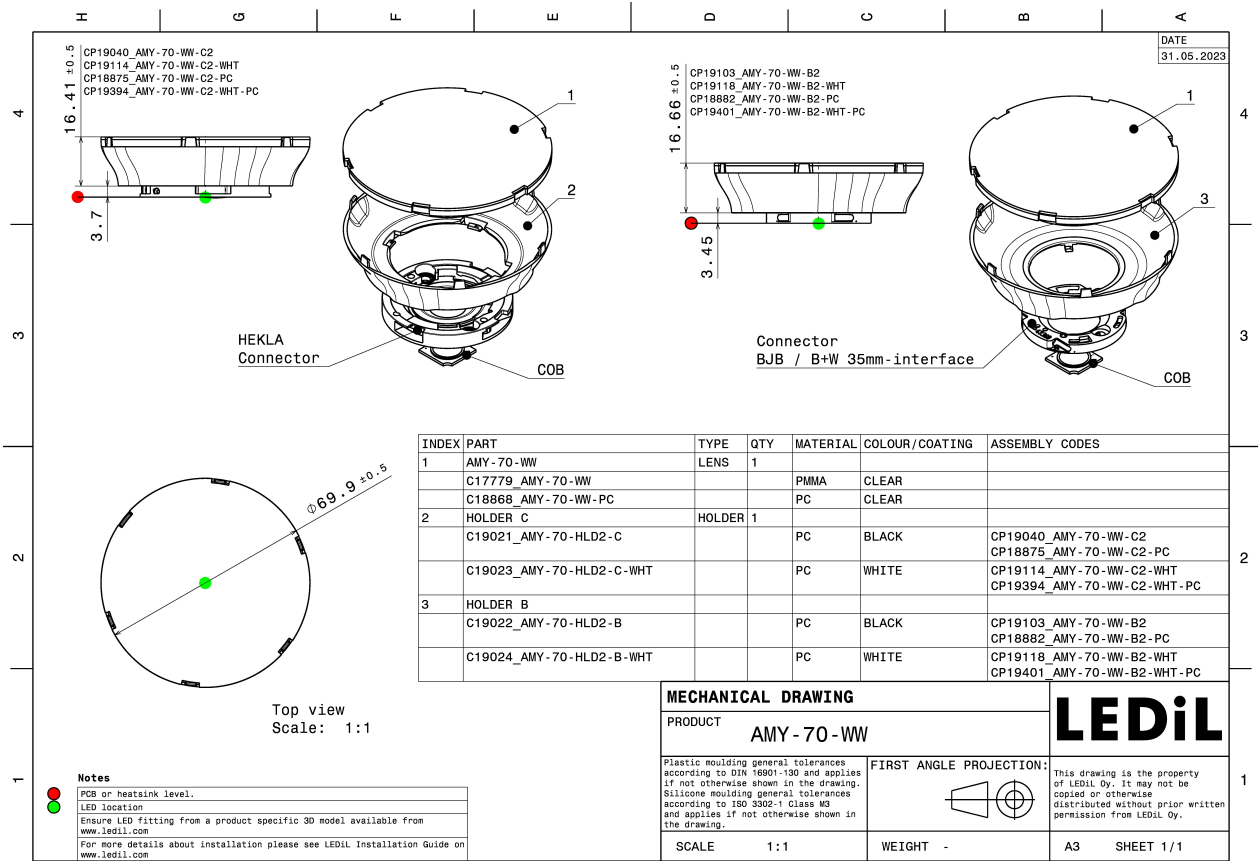

See also our general installation guide: www.ledil.com/installation_guide

OPTICAL RESULTS (MEASURED):



OPTICAL RESULTS (MEASURED):

CITIZEN

LED CLL02x/CLU02x (LES10)
Ordering code CP19040_AMY-70-WW-C2
FWHM / FWTM 54.0° / 75.0°
Efficiency 87 %
LEDs/each optic 1
Light colour White
Required components:
F17435_HEKLA-G2-C

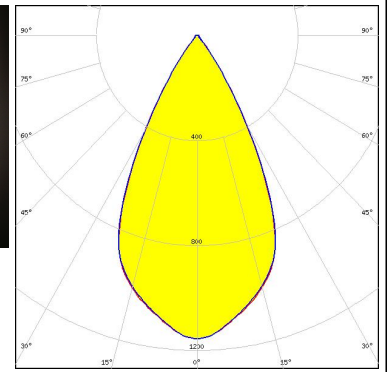
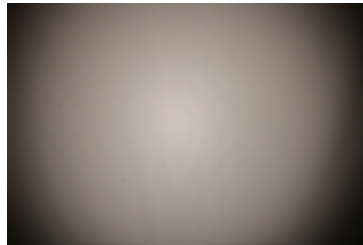

CITIZEN

LED CLU700/701/702/703
Ordering code CP19103_AMY-70-WW-B2
FWHM / FWTM 53.0° / 73.0°
Efficiency 89 %
LEDs/each optic 1
Light colour White
Required components:
BJB: 47.360.1020

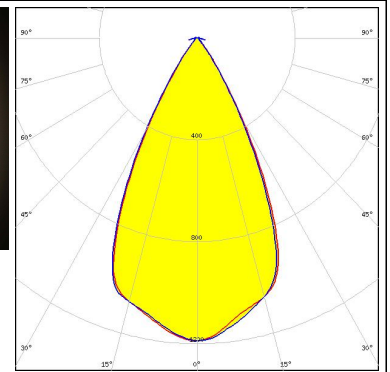
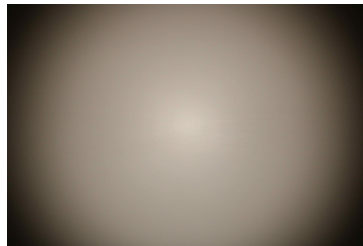

CITIZEN

LED CLU7S3
Ordering code CP19103_AMY-70-WW-B2
FWHM / FWTM 55.0° / 73.0°
Efficiency 91 %
LEDs/each optic 1
Light colour White
Required components:
Bender Wirth: 667a Bayonet35

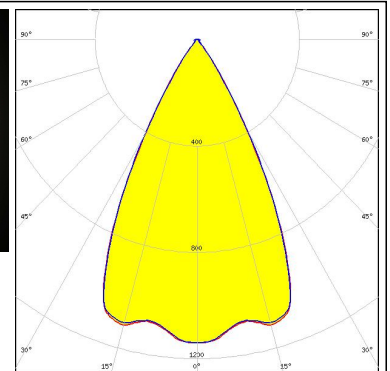
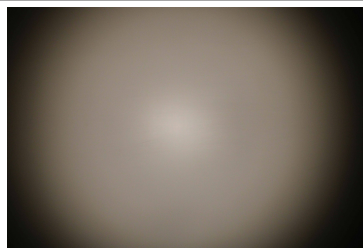



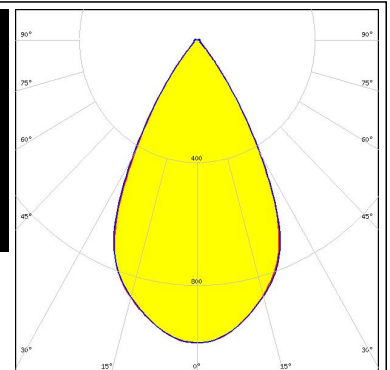
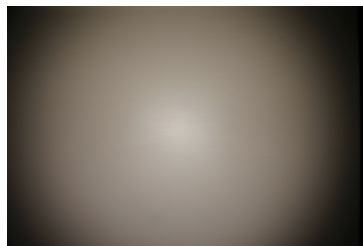

CREE LEDs

LED CMU15xx
Ordering code CP19040_AMY-70-WW-C2
FWHM / FWTM 57.0° / 80.0°
Efficiency 85 %
LEDs/each optic 1
Light colour White
Required components:
F17438_HEKLA-G2-I

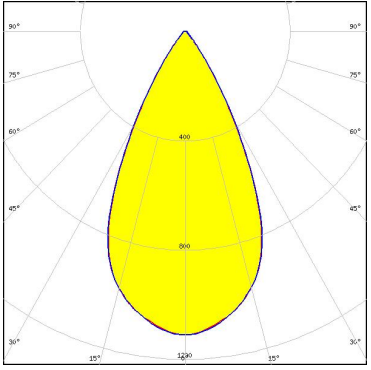

OPTICAL RESULTS (MEASURED):

			
LED LUXEON Fusion 12-up (20x24) Ordering code CP19040_AMY-70-WW-C2 FWHM / FWTM 53.0° / 76.0° Efficiency 86 % LEDs/each optic 1 Light colour White Required components: C16142_HEKLA-SOCKET-K F18158_HEKLA-RZ-LENS Bender Wirth: 442 Typ L8			

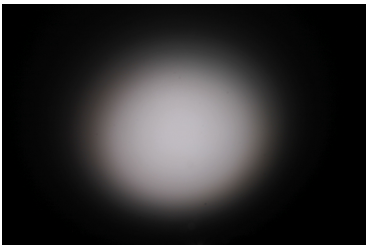
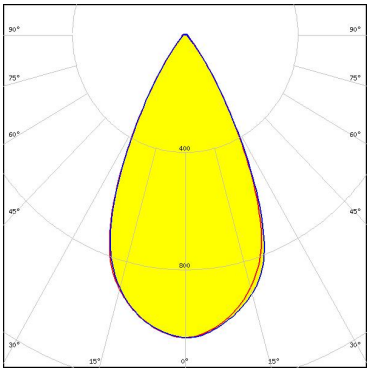
			
LED LUXEON Fusion 21-up (20x24) Ordering code CP19040_AMY-70-WW-C2 FWHM / FWTM 53.0° / 76.0° Efficiency 80 % LEDs/each optic 1 Light colour White Required components: C16142_HEKLA-SOCKET-K F18158_HEKLA-RZ-LENS Bender Wirth: 442 Typ L8			

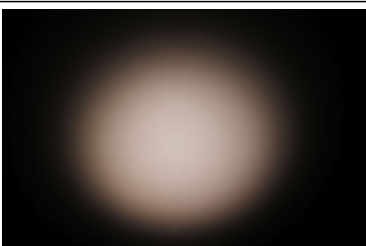
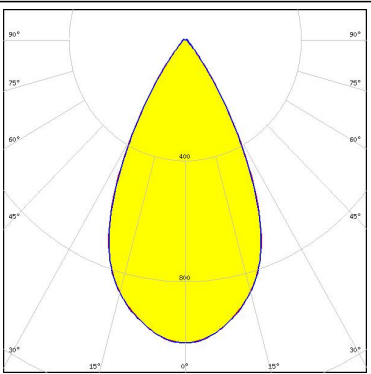
			
LED LUXEON Fusion 27-up (20x24) Ordering code CP19040_AMY-70-WW-C2 FWHM / FWTM 54.0° / 78.0° Efficiency 80 % LEDs/each optic 1 Light colour White Required components: C16142_HEKLA-SOCKET-K F18158_HEKLA-RZ-LENS Bender Wirth: 442 Typ L8			

			
LED CTM-14 (Tunable White) Gen2 Ordering code CP19040_AMY-70-WW-C2 FWHM / FWTM 56.0° / 78.0° Efficiency 86 % LEDs/each optic 1 Light colour White Required components: C16142_HEKLA-SOCKET-K Bender Wirth: 442 Typ L8			

OPTICAL RESULTS (MEASURED):

SAMSUNG

LED LC016D / LC019D / LC026D / LC033D
Ordering code C17779_AMY-70-WW
FWHM / FWTM 58.0° / 79.0°
Efficiency 87 %
LEDs/each optic 1
Light colour White
Required components:

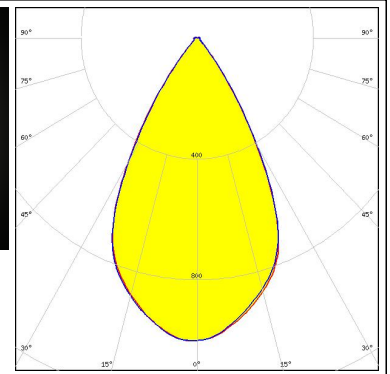
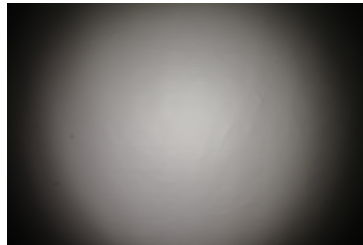

SAMSUNG

LED LC016D / LC019D / LC026D / LC033D
Ordering code CP19040_AMY-70-WW-C2
FWHM / FWTM 58.0° / 79.0°
Efficiency 87 %
LEDs/each optic 1
Light colour White
Required components:
F15859_HEKLA-SOCKET-I

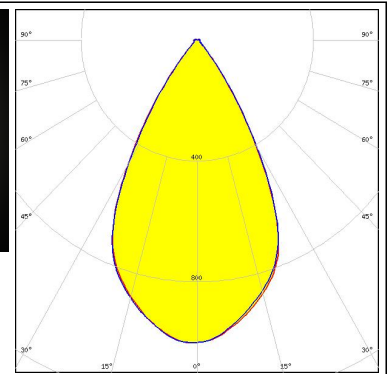
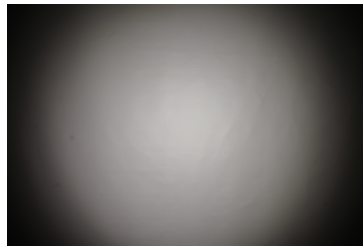

OPTICAL RESULTS (SIMULATED):

bridgelux

LED V10 Gen 8-9
 Ordering code CP19103_AMY-70-WW-B2
 FWHM / FWTM 55.0° / 76.0°
 Efficiency 88 %
 Peak intensity 1.2 cd/lm
 LEDs/each optic 1
 Light colour White
 Required components:
 BJB: 47.360.1020

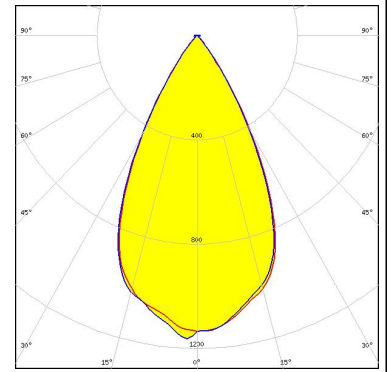

bridgelux

LED V18 Gen 8-9
 Ordering code CP19040_AMY-70-WW-C2
 FWHM / FWTM 62.0° / 86.0°
 Efficiency 83 %
 Peak intensity 0.8 cd/lm
 LEDs/each optic 1
 Light colour White
 Required components:
 Bender Wirth: 639b Hekla XL

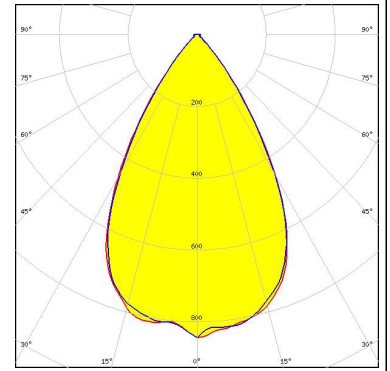

bridgelux

LED V3 HD Gen 8
 Ordering code CP19040_AMY-70-WW-C2
 FWHM / FWTM 52.0° / 72.0°
 Efficiency 91 %
 Peak intensity 1.3 cd/lm
 LEDs/each optic 1
 Light colour White
 Required components:
 F15253_HEKLA-SOCKET-A

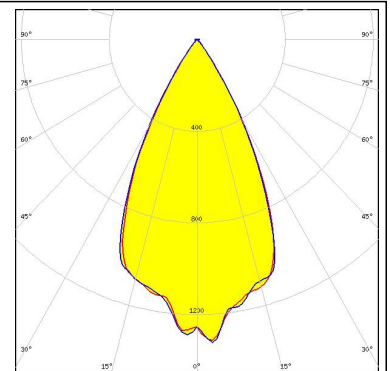

bridgelux

LED V3 HD Gen 8 FC
 Ordering code CP19040_AMY-70-WW-C2
 FWHM / FWTM 52.0° / 72.0°
 Efficiency 90 %
 Peak intensity 1.4 cd/lm
 LEDs/each optic 1
 Light colour White
 Required components:
 F15255_HEKLA-SOCKET-C

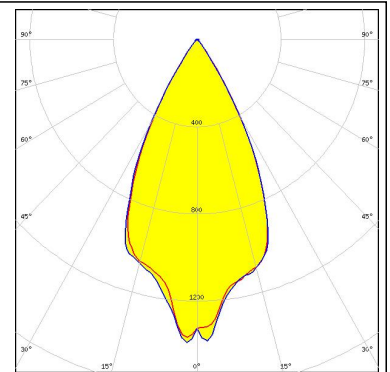

OPTICAL RESULTS (SIMULATED):

bridgelux

LED V4 HD Gen 8
 Ordering code CP19040_AMY-70-WW-C2
 FWHM / FWTM 54.0° / 72.0°
 Efficiency 91 %
 Peak intensity 1.3 cd/lm
 LEDs/each optic 1
 Light colour White
 Required components:
 F15253_HEKLA-SOCKET-A

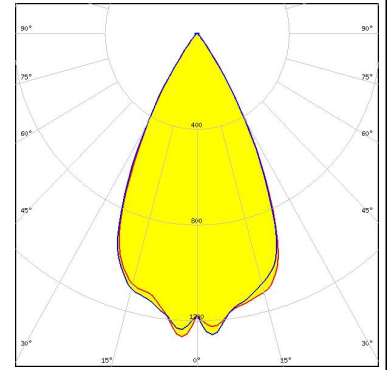

bridgelux

LED V6 Gen 8-9
 Ordering code CP19040_AMY-70-WW-C2
 FWHM / FWTM 55.0° / 74.0°
 Efficiency 90 %
 Peak intensity 1.2 cd/lm
 LEDs/each optic 1
 Light colour White
 Required components:
 F15253_HEKLA-SOCKET-A

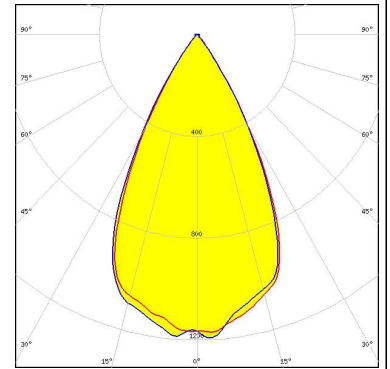

bridgelux

LED V6 Gen 8-9
 Ordering code CP19040_AMY-70-WW-C2
 FWHM / FWTM 55.0° / 74.0°
 Efficiency 94 %
 Peak intensity 1.2 cd/lm
 LEDs/each optic 1
 Light colour White
 Required components:
 F15253_HEKLA-SOCKET-A

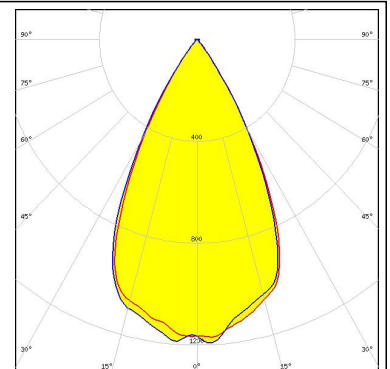

bridgelux

LED V6 HD Gen 8
 Ordering code CP19040_AMY-70-WW-C2
 FWHM / FWTM 52.0° / 73.0°
 Efficiency 90 %
 Peak intensity 1.3 cd/lm
 LEDs/each optic 1
 Light colour White
 Required components:
 F15255_HEKLA-SOCKET-C

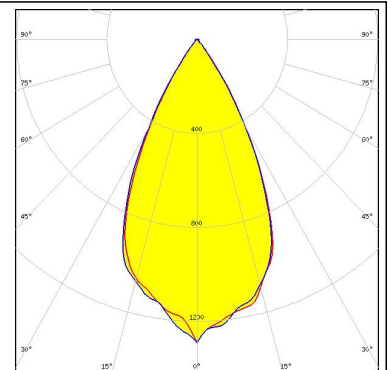

OPTICAL RESULTS (SIMULATED):

		
LED	V8 Gen7	
Ordering code	CP19040_AMY-70-WW-C2	
FWHM / FWTM	55.0° / 74.0°	
Efficiency	87 %	
Peak intensity	1.2 cd/lm	
LEDs/each optic	1	
Light colour	White	
Required components:		
F15253_HEKLA-SOCKET-A		

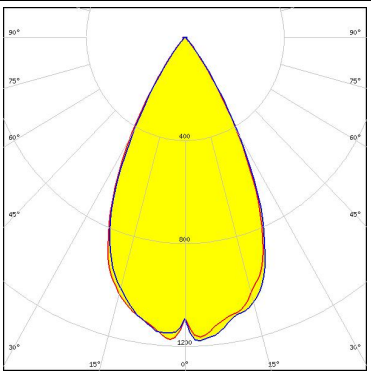
		
LED	V9 HD Gen 8	
Ordering code	CP19040_AMY-70-WW-C2	
FWHM / FWTM	54.0° / 74.0°	
Efficiency	89 %	
Peak intensity	1.2 cd/lm	
LEDs/each optic	1	
Light colour	White	
Required components:		
F15859_HEKLA-SOCKET-I		

		
LED	VERO10	
Ordering code	CP19040_AMY-70-WW-C2	
FWHM / FWTM	54.0° / 74.0°	
Efficiency	87 %	
Peak intensity	1.2 cd/lm	
LEDs/each optic	1	
Light colour	White	
Required components:		
F15616_HEKLA-SOCKET-F		

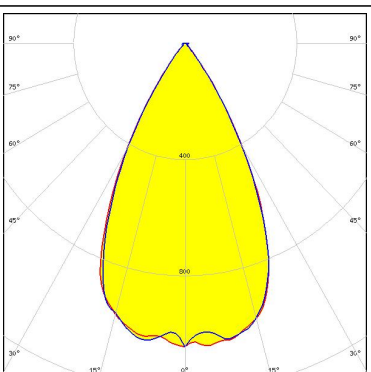
		
LED	VERO13	
Ordering code	CP19040_AMY-70-WW-C2	
FWHM / FWTM	56.0° / 76.0°	
Efficiency	85 %	
Peak intensity	1.1 cd/lm	
LEDs/each optic	1	
Light colour	White	
Required components:		
C16142_HEKLA-SOCKET-K		

OPTICAL RESULTS (SIMULATED):



LED VERO18
Ordering code CP19040_AMY-70-WW-C2
FWHM / FWTM 62.0° / 88.0°
Efficiency 87 %
Peak intensity 0.9 cd/lm
LEDs/each optic 1
Light colour White
Required components:
 C16142_HEKLA-SOCKET-K

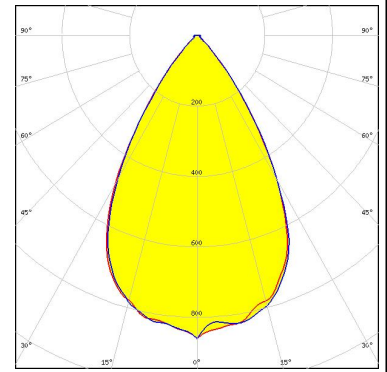

LED Vesta DTW 13mm (21W)
Ordering code CP19040_AMY-70-WW-C2
FWHM / FWTM 53.0° / 74.0°
Efficiency 89 %
Peak intensity 1.3 cd/lm
LEDs/each optic 1
Light colour White
Required components:
 Bender Wirth: 632b Hekla XL

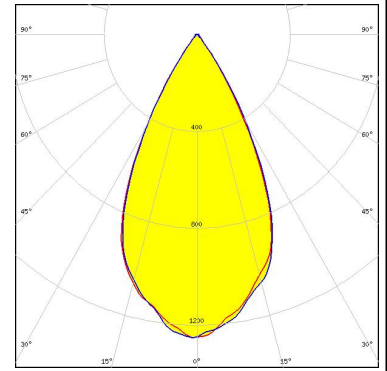

LED Vesta DTW 15mm (33W)
Ordering code CP19040_AMY-70-WW-C2
FWHM / FWTM 55.0° / 79.0°
Efficiency 87 %
Peak intensity 1.1 cd/lm
LEDs/each optic 1
Light colour White
Required components:
 Bender Wirth: 632b Hekla XL

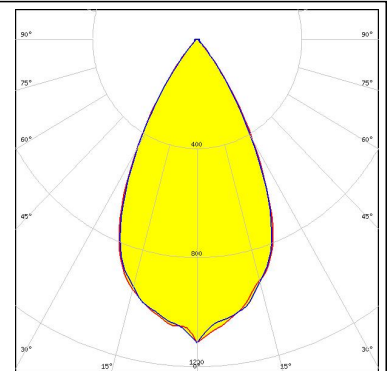

LED Vesta DTW 6mm
Ordering code CP19040_AMY-70-WW-C2
FWHM / FWTM 54.0° / 74.0°
Efficiency 89 %
Peak intensity 1.2 cd/lm
LEDs/each optic 1
Light colour White
Required components:
 Bender Wirth: 652b Hekla

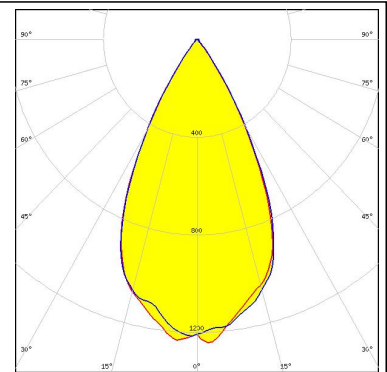

OPTICAL RESULTS (SIMULATED):



LED Vesta DTW 9mm (4W/6W/12W)
Ordering code CP19040_AMY-70-WW-C2
FWHM / FWTM 53.0° / 74.0°
Efficiency 89 %
Peak intensity 1.2 cd/lm
LEDs/each optic 1
Light colour White
Required components:
 Bender Wirth: 652b Hekla

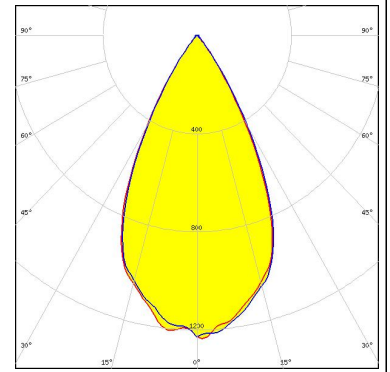

LED Vesta SE 13mm TW
Ordering code CP19040_AMY-70-WW-C2
FWHM / FWTM 55.0° / 77.0°
Efficiency 84 %
Peak intensity 1.1 cd/lm
LEDs/each optic 1
Light colour Tunable White
Required components:
 C16142_HEKLA-SOCKET-K

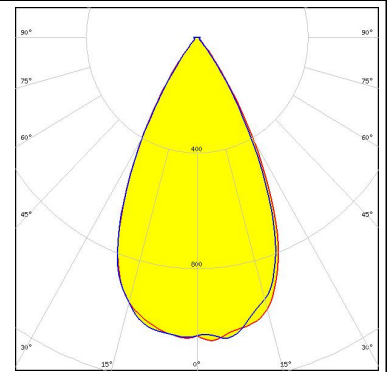

LED Vesta TW 9mm (9W) DP
Ordering code CP19040_AMY-70-WW-C2
FWHM / FWTM 54.0° / 78.0°
Efficiency 90 %
Peak intensity 1.2 cd/lm
LEDs/each optic 1
Light colour White
Required components:
 C16142_HEKLA-SOCKET-K
 Bender Wirth: 489 Typ L8

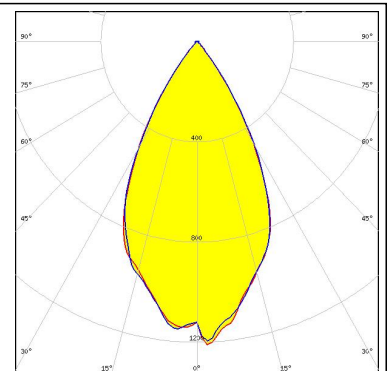

CITIZEN

LED CLL03x/CLU03x
Ordering code CP19040_AMY-70-WW-C2
FWHM / FWTM 56.0° / 78.0°
Efficiency 85 %
Peak intensity 1 cd/lm
LEDs/each optic 1
Light colour White
Required components:
 F15859_HEKLA-SOCKET-I

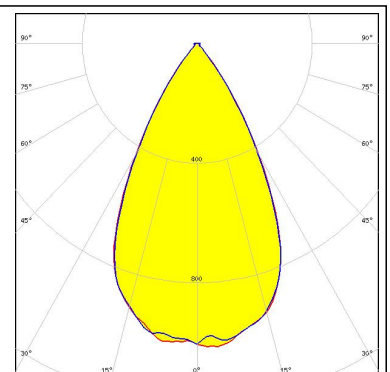

OPTICAL RESULTS (SIMULATED):

CITIZEN

LED CLL04x/CLU04x
 Ordering code CP19040_AMY-70-WW-C2
 FWHM / FWTM 64.0° / 90.0°
 Efficiency 78 %
 Peak intensity 0.7 cd/lm
 LEDs/each optic 1
 Light colour White
 Required components:
 Bender Wirth: 631a Hekla XL

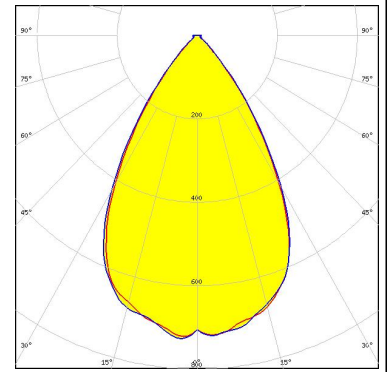

CITIZEN

LED CLU700/701/702/703
 Ordering code CP19040_AMY-70-WW-C2
 FWHM / FWTM 52.0° / 72.0°
 Efficiency 88 %
 Peak intensity 1.3 cd/lm
 LEDs/each optic 1
 Light colour White
 Required components:
 F15255_HEKLA-SOCKET-C

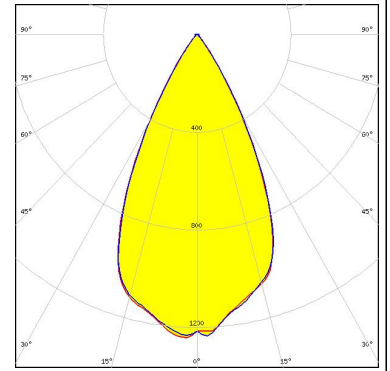

CITIZEN

LED CLU700/701/702/703
 Ordering code CP19040_AMY-70-WW-C2
 FWHM / FWTM 52.0° / 72.0°
 Efficiency 89 %
 Peak intensity 1.3 cd/lm
 LEDs/each optic 1
 Light colour White
 Required components:
 F15255_HEKLA-SOCKET-C

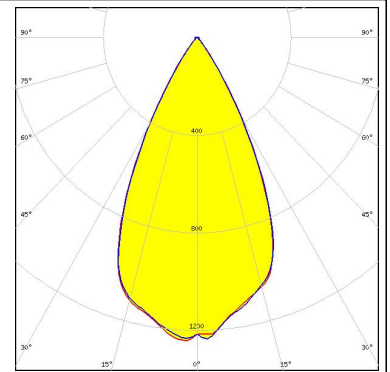

CREE^{LEDs}

LED CMA1825
 Ordering code CP19040_AMY-70-WW-C2
 FWHM / FWTM 56.0° / 78.0°
 Efficiency 86 %
 Peak intensity 1.1 cd/lm
 LEDs/each optic 1
 Light colour White
 Required components:
 F15254_HEKLA-SOCKET-B

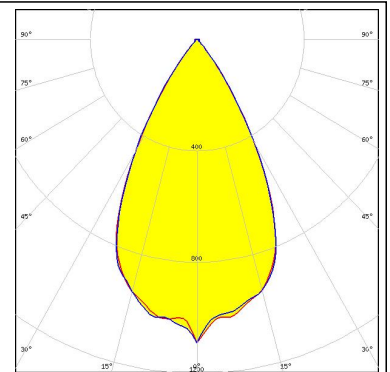

OPTICAL RESULTS (SIMULATED):



LED CMT14xx
Ordering code CP19040_AMY-70-WW-C2
FWHM / FWTM 54.0° / 75.0°
Efficiency 86 %
Peak intensity 1.2 cd/lm
LEDs/each optic 1
Light colour White
Required components:
F17435_HEKLA-G2-C

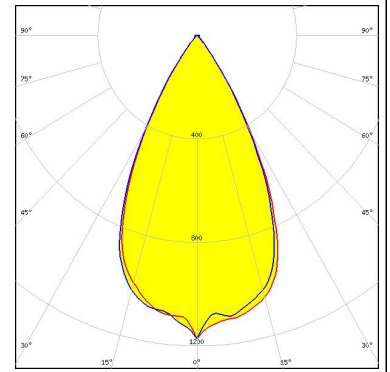

LED CMU10xx
Ordering code CP19040_AMY-70-WW-C2
FWHM / FWTM 55.0° / 76.0°
Efficiency 87 %
Peak intensity 1.1 cd/lm
LEDs/each optic 1
Light colour White
Required components:
F17435_HEKLA-G2-C

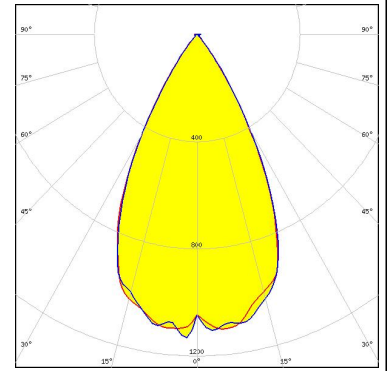

LED CMU10xx
Ordering code CP19103_AMY-70-WW-B2
FWHM / FWTM 55.0° / 76.0°
Efficiency 88 %
Peak intensity 1.2 cd/lm
LEDs/each optic 1
Light colour White
Required components:
BJB: 47.360.1020

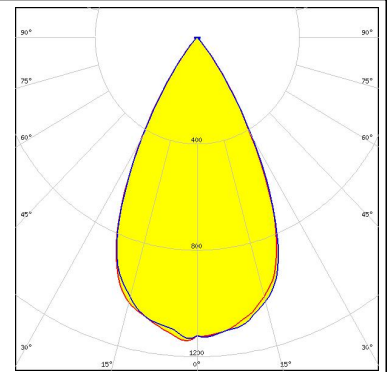

LED CXA/B 15xx
Ordering code CP19040_AMY-70-WW-C2
FWHM / FWTM 55.0° / 74.0°
Efficiency 86 %
Peak intensity 1.1 cd/lm
LEDs/each optic 1
Light colour White
Required components:
F15256_HEKLA-SOCKET-D

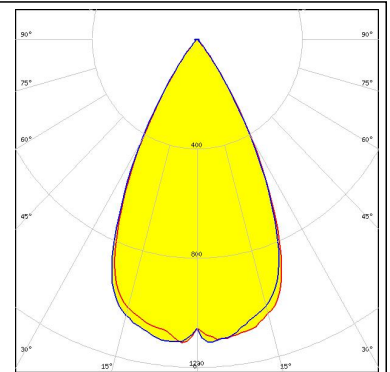

OPTICAL RESULTS (SIMULATED):



LED CXA/B 1830
Ordering code C17779_AMY-70-WW
FWHM / FWTM 56.0° / 80.0°
Efficiency 91 %
Peak intensity 1.1 cd/lm
LEDs/each optic 1
Light colour White
Required components:
 Bender Wirth: 637b Hekla

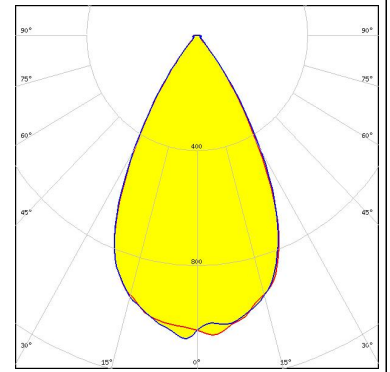

LED CXA/B 1830
Ordering code CP19040_AMY-70-WW-C2
FWHM / FWTM 56.0° / 79.0°
Efficiency 86 %
Peak intensity 1.1 cd/lm
LEDs/each optic 1
Light colour White
Required components:
 Bender Wirth: 637b Hekla

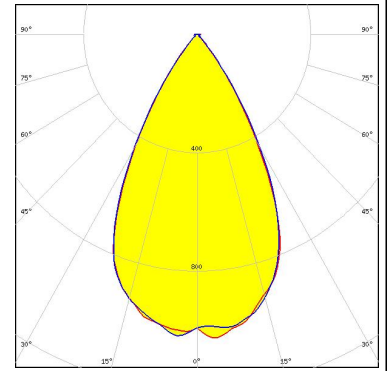

LED LUXEON CX Plus CoB L08 (Gen2)
Ordering code CP19040_AMY-70-WW-C2
FWHM / FWTM 54.0° / 79.0°
Efficiency 89 %
Peak intensity 1.2 cd/lm
LEDs/each optic 1
Light colour White
Required components:
 Bender Wirth: 637a Hekla

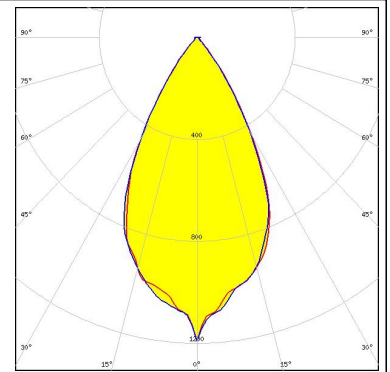

LED LUXEON 7070
FWHM / FWTM 51.0° / 72.0°
Efficiency 94 %
Peak intensity 1.3 cd/lm
LEDs/each optic 1
Light colour White
Required components:

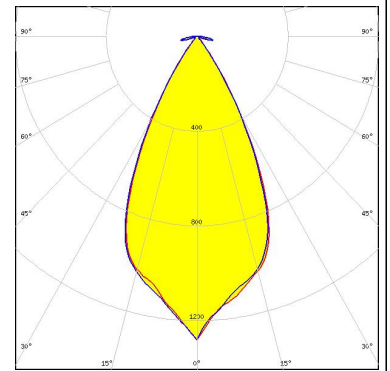

OPTICAL RESULTS (SIMULATED):

LUMILEDS

LED LUXEON CoB 1204/1205
Ordering code CP19040_AMY-70-WW-C2
FWHM / FWTM 56.0° / 78.0°
Efficiency 88 %
Peak intensity 1.1 cd/lm
LEDs/each optic 1
Light colour White
Required components:
Bender Wirth: 632a Hekla XL

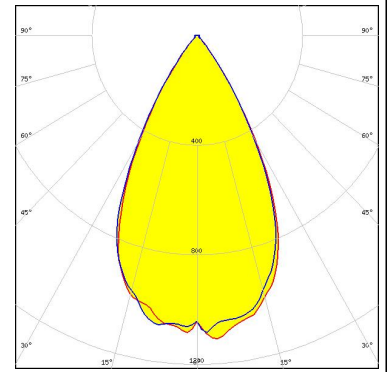

LUMILEDS

LED LUXEON CoB 1204HD
Ordering code CP19040_AMY-70-WW-C2
FWHM / FWTM 54.0° / 75.0°
Efficiency 89 %
Peak intensity 1.2 cd/lm
LEDs/each optic 1
Light colour White
Required components:
F15858_HEKLA-SOCKET-H

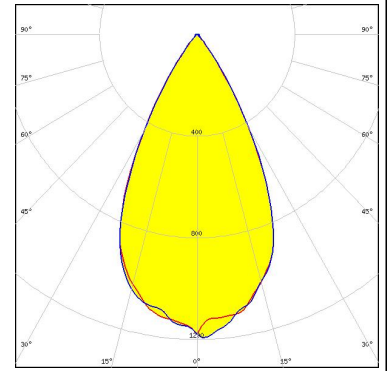

LUMILEDS

LED LUXEON CoB 1205HD
Ordering code CP19040_AMY-70-WW-C2
FWHM / FWTM 56.0° / 76.0°
Efficiency 88 %
Peak intensity 1.1 cd/lm
LEDs/each optic 1
Light colour White
Required components:
F15858_HEKLA-SOCKET-H

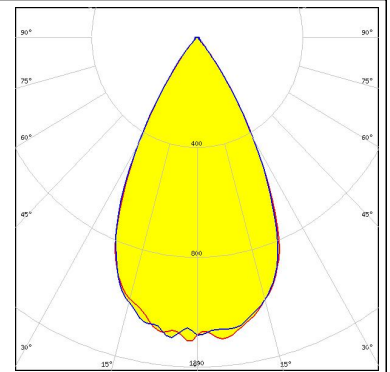

LUMILEDS

LED LUXEON CoB 1208
Ordering code CP19040_AMY-70-WW-C2
FWHM / FWTM 56.0° / 79.0°
Efficiency 88 %
Peak intensity 1.1 cd/lm
LEDs/each optic 1
Light colour White
Required components:
Bender Wirth: 632a Hekla XL

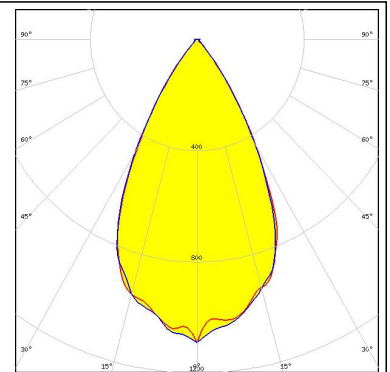

OPTICAL RESULTS (SIMULATED):

LUMILEDS

LED LUXEON CX Plus CoB - HD S02H6
Ordering code CP19103_AMY-70-WW-B2
FWHM / FWTM 52.0° / 73.0°
Efficiency 90 %
Peak intensity 1.4 cd/lm
LEDs/each optic 1
Light colour White
Required components:
Bender Wirth: 634c Bayonet35L

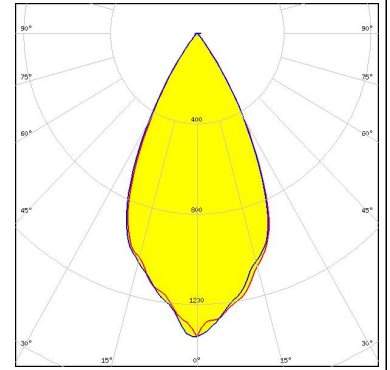

LUMILEDS

LED LUXEON CX Plus CoB - HD S04H9
Ordering code CP19040_AMY-70-WW-C2
FWHM / FWTM 54.0° / 76.0°
Efficiency 87 %
Peak intensity 1.2 cd/lm
LEDs/each optic 1
Light colour White
Required components:
F15255_HEKLA-SOCKET-C

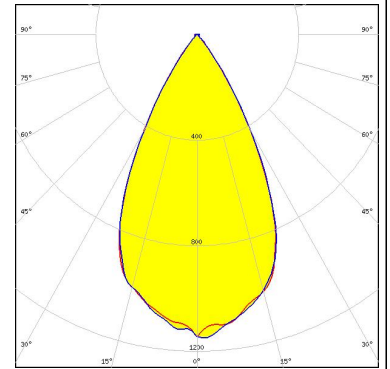

LUMILEDS

LED LUXEON CX Plus CoB - HD S04H9
Ordering code CP19103_AMY-70-WW-B2
FWHM / FWTM 53.0° / 75.0°
Efficiency 89 %
Peak intensity 1.3 cd/lm
LEDs/each optic 1
Light colour White
Required components:
Bender Wirth: 634a Bayonet35L

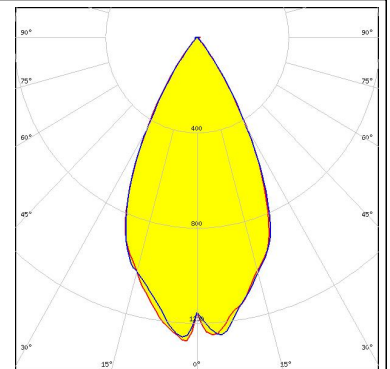

LUMILEDS

LED LUXEON CX Plus CoB L04 / L05 (Gen2)
Ordering code CP19040_AMY-70-WW-C2
FWHM / FWTM 55.0° / 77.0°
Efficiency 89 %
Peak intensity 1.2 cd/lm
LEDs/each optic 1
Light colour White
Required components:
F15254_HEKLA-SOCKET-B

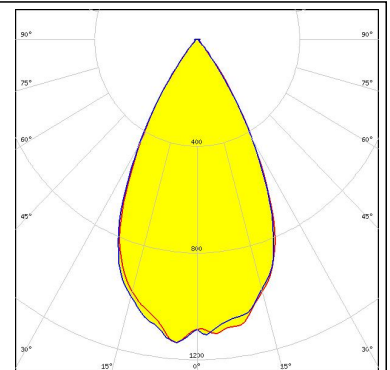

OPTICAL RESULTS (SIMULATED):

LUMILEDS

LED LUXEON CX Plus CoB M02 / M03 (Gen2)
 Ordering code CP19040_AMY-70-WW-C2
 FWHM / FWTM 54.0° / 76.0°
 Efficiency 90 %
 Peak intensity 1.2 cd/lm
 LEDs/each optic 1
 Light colour White
 Required components:
 F15256_HEKLA-SOCKET-D

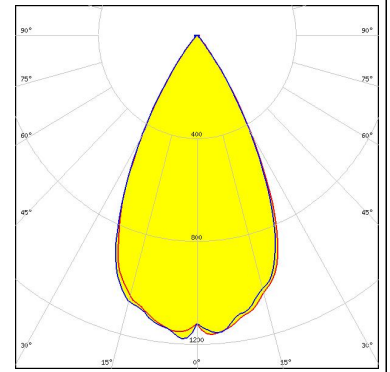

LUMILEDS

LED LUXEON CX Plus CoB S01 (Gen2)
 Ordering code CP19040_AMY-70-WW-C2
 FWHM / FWTM 54.0° / 74.0°
 Efficiency 91 %
 Peak intensity 1.3 cd/lm
 LEDs/each optic 1
 Light colour White
 Required components:
 F15956_HEKLA-SOCKET-J

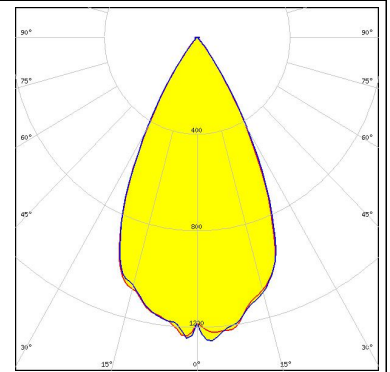

LUMINUS

LED CHM-9 XH (19x19)
 Ordering code CP18764_YASMEEN-70-WW-C2
 FWHM / FWTM 56.0° / 76.0°
 Efficiency 81 %
 Peak intensity 1 cd/lm
 LEDs/each optic 1
 Light colour White
 Required components:
 F15859_HEKLA-SOCKET-I

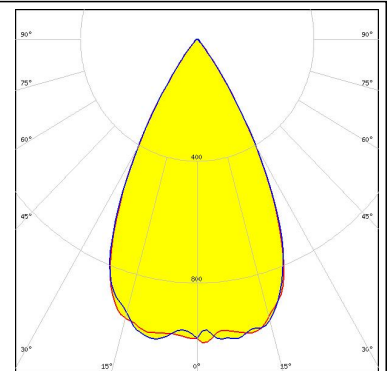

LUMINUS

LED CHM-9 XH (19x19)
 Ordering code CP19040_AMY-70-WW-C2
 FWHM / FWTM 52.0° / 74.0°
 Efficiency 90 %
 Peak intensity 1.3 cd/lm
 LEDs/each optic 1
 Light colour White
 Required components:
 F15859_HEKLA-SOCKET-I

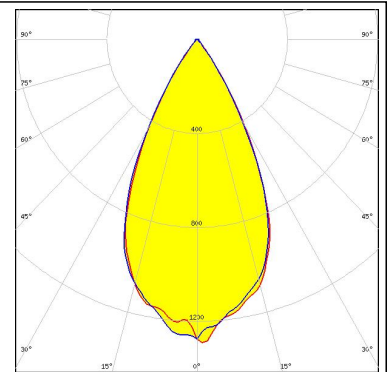

OPTICAL RESULTS (SIMULATED):



LED CTM-6 (Tunable White) Gen2
Ordering code CP19040_AMY-70-WW-C2
FWHM / FWTM 50.0° / 72.0°
Efficiency 90 %
Peak intensity 1.4 cd/lm
LEDs/each optic 1
Light colour Tunable White
Required components:
 C16142_HEKLA-SOCKET-K
 Bender Wirth: 495 Typ L8

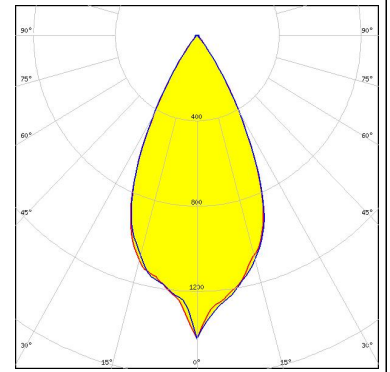

LED CTM-9 (Tunable White) Gen2
Ordering code CP19040_AMY-70-WW-C2
FWHM / FWTM 52.0° / 74.0°
Efficiency 89 %
Peak intensity 1.3 cd/lm
LEDs/each optic 1
Light colour Tunable White
Required components:
 C16142_HEKLA-SOCKET-K
 Bender Wirth: 495 Typ L8

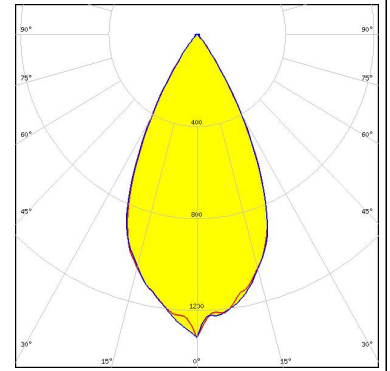

LED CxM-14 (19x19)
Ordering code CP19040_AMY-70-WW-C2
FWHM / FWTM 58.0° / 81.0°
Efficiency 84 %
Peak intensity 1 cd/lm
LEDs/each optic 1
Light colour White
Required components:
 F17438_HEKLA-G2-I

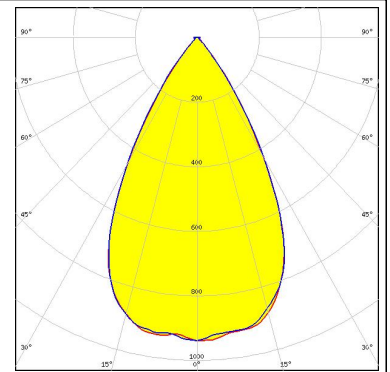

LED CXM-3
Ordering code CP19103_AMY-70-WW-B2
FWHM / FWTM 51.0° / 70.0°
Efficiency 90 %
Peak intensity 1.5 cd/lm
LEDs/each optic 1
Light colour White
Required components:
 Bender Wirth: 634a Bayonet35L

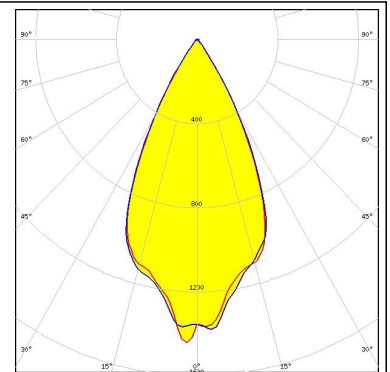

OPTICAL RESULTS (SIMULATED):



LED CXM-4
Ordering code CP19103_AMY-70-WW-B2
FWHM / FWTM 51.0° / 72.0°
Efficiency 90 %
Peak intensity 1.4 cd/lm
LEDs/each optic 1
Light colour White
Required components:
 Bender Wirth: 634a Bayonet35L

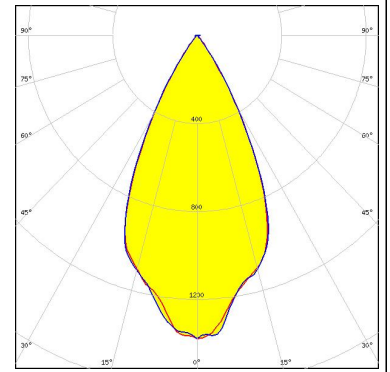

LED CxM-6 (13.5x13.5)
Ordering code CP19103_AMY-70-WW-B2
FWHM / FWTM 54.0° / 72.0°
Efficiency 90 %
Peak intensity 1.3 cd/lm
LEDs/each optic 1
Light colour White
Required components:
 BJB: 47.360.1020

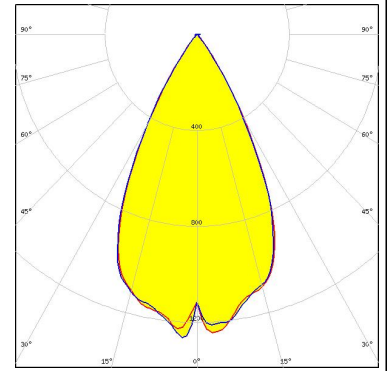

LED COB J-Type
Ordering code CP19040_AMY-70-WW-C2
FWHM / FWTM 54.0° / 79.0°
Efficiency 89 %
Peak intensity 1.2 cd/lm
LEDs/each optic 1
Light colour White
Required components:
 Bender Wirth: 663a Hekla XL

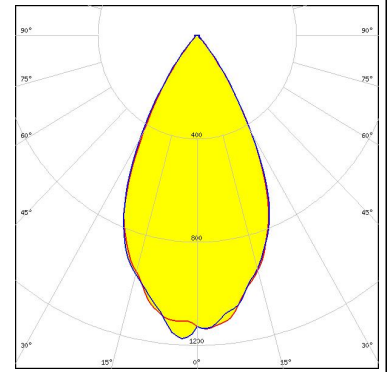

LED COB L-Type (LES 11)
Ordering code CP19040_AMY-70-WW-C2
FWHM / FWTM 56.0° / 77.0°
Efficiency 86 %
Peak intensity 1.1 cd/lm
LEDs/each optic 1
Light colour White
Required components:
 F17437_HEKLA-G2-H

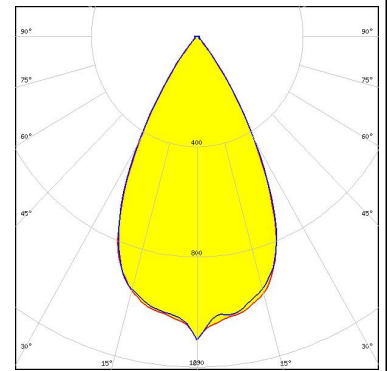

OPTICAL RESULTS (SIMULATED):



LED COB S-Type (LES 6)
Ordering code CP19103_AMY-70-WW-B2
FWHM / FWTM 52.0° / 72.0°
Efficiency 90 %
Peak intensity 1.4 cd/lm
LEDs/each optic 1
Light colour White
Required components:
 Bender Wirth: 652a Bayonet35L

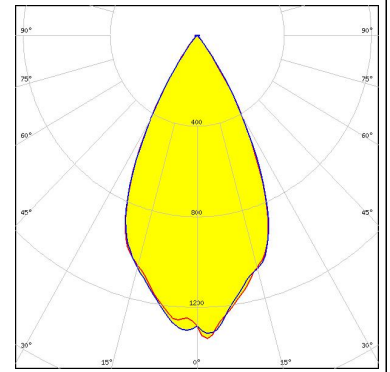

LED COB S-Type (LES 7)
Ordering code CP19103_AMY-70-WW-B2
FWHM / FWTM 52.0° / 73.0°
Efficiency 90 %
Peak intensity 1.4 cd/lm
LEDs/each optic 1
Light colour White
Required components:
 Bender Wirth: 652a Bayonet35L

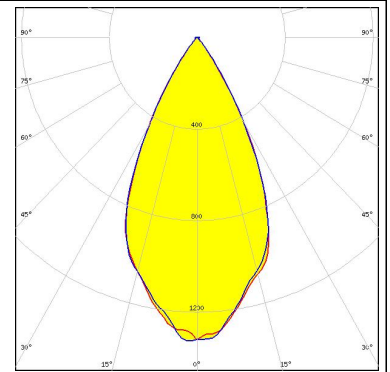

LED COB T-Type
Ordering code CP19103_AMY-70-WW-B2
FWHM / FWTM 52.0° / 72.0°
Efficiency 90 %
Peak intensity 1.4 cd/lm
LEDs/each optic 1
Light colour White
Required components:
 Bender Wirth: 652a Bayonet35L

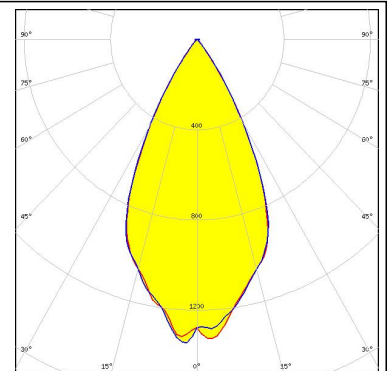

LED NJCWL024Z-V1MT: COB L-Type Tunable White
Ordering code CP19040_AMY-70-WW-C2
FWHM / FWTM 52.0° / 74.0°
Efficiency 90 %
Peak intensity 1.4 cd/lm
LEDs/each optic 1
Light colour Tunable White
Required components:
 C16142_HEKLA-SOCKET-K
 Bender Wirth: 497 Typ L8 HV

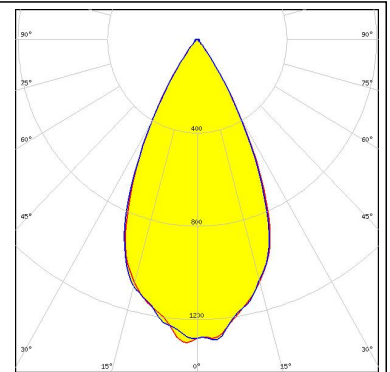

OPTICAL RESULTS (SIMULATED):



LED NJNWS012Z-V1MT: COB S-Type Tunable White
Ordering code CP19040_AMY-70-WW-C2
FWHM / FWTM 50.0° / 72.0°
Efficiency 90 %
Peak intensity 1.4 cd/lm
LEDs/each optic 1
Light colour Tunable White
Required components:
C16142_HEKLA-SOCKET-K
Bender Wirth: 495 Typ L8 HV

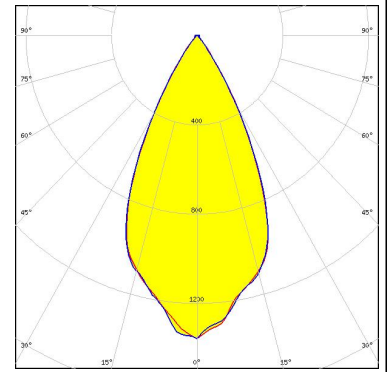

LED NVCWJ024Z-V1MT: COB J-Type Tunable White
Ordering code CP19040_AMY-70-WW-C2
FWHM / FWTM 54.0° / 76.0°
Efficiency 89 %
Peak intensity 1.2 cd/lm
LEDs/each optic 1
Light colour Tunable White
Required components:
C16142_HEKLA-SOCKET-K
Bender Wirth: 498 Typ L8 HV

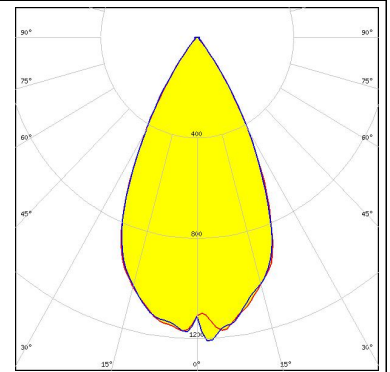

LED PrevaLED Core G7 LES15 CoB
Ordering code CP19040_AMY-70-WW-C2
FWHM / FWTM 58.0° / 80.0°
Efficiency 85 %
Peak intensity 1 cd/lm
LEDs/each optic 1
Light colour White
Required components:
F17438_HEKLA-G2-I

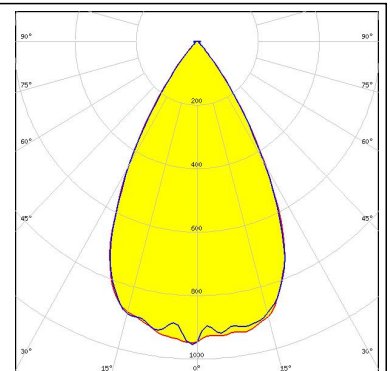

LED LC003D / LC006D / LC009D / LC013D
Ordering code CP19040_AMY-70-WW-C2
FWHM / FWTM 54.0° / 76.0°
Efficiency 88 %
Peak intensity 1.2 cd/lm
LEDs/each optic 1
Light colour White
Required components:
F15255_HEKLA-SOCKET-C

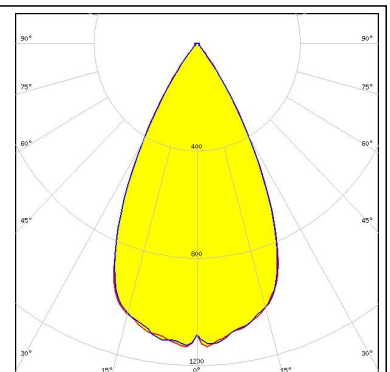

OPTICAL RESULTS (SIMULATED):

SAMSUNG

LED LC010C G2
Ordering code CP19103_AMY-70-WW-B2
FWHM / FWTM 53.0° / 72.0°
Efficiency 90 %
Peak intensity 1.3 cd/lm
LEDs/each optic 1
Light colour White
Required components:
BJB: 47.360.1020

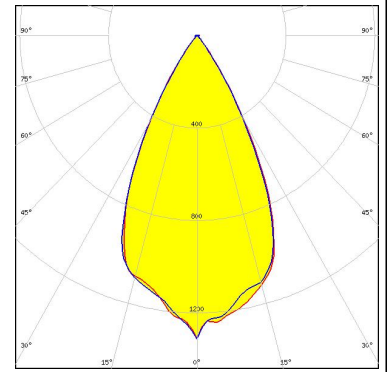

SAMSUNG

LED LC010T (Tunable White)
Ordering code CP19040_AMY-70-WW-C2
FWHM / FWTM 50.0° / 72.0°
Efficiency 90 %
Peak intensity 1.4 cd/lm
LEDs/each optic 1
Light colour Tunable White
Required components:
Bender Wirth: 501 Typ L8

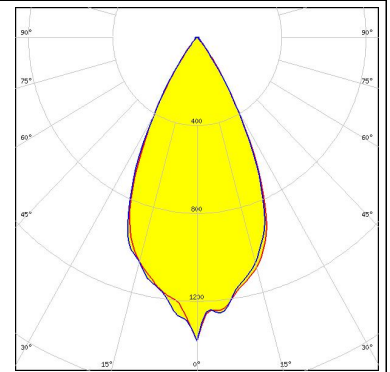

SAMSUNG

LED LC020C G2
Ordering code CP19103_AMY-70-WW-B2
FWHM / FWTM 54.0° / 74.0°
Efficiency 88 %
Peak intensity 1.2 cd/lm
LEDs/each optic 1
Light colour White
Required components:
BJB: 47.360.1010

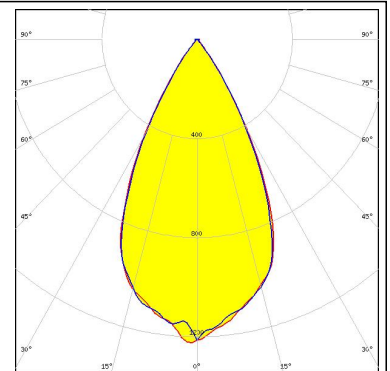

SAMSUNG

LED LC020T (Tunable white)
Ordering code CP19040_AMY-70-WW-C2
FWHM / FWTM 54.0° / 76.0°
Efficiency 90 %
Peak intensity 1.2 cd/lm
LEDs/each optic 1
Light colour Tunable White
Required components:
C16142_HEKLA-SOCKET-K
Bender Wirth: 501 Typ L8

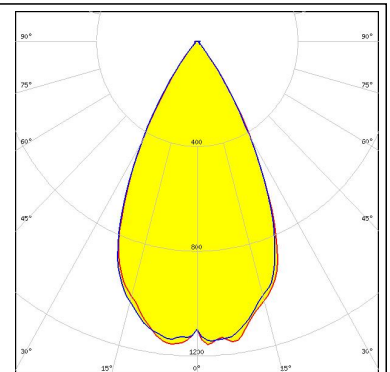

OPTICAL RESULTS (SIMULATED):

SAMSUNG

LED LC020T (Tunable white)
Ordering code CP19040_AMY-70-WW-C2
FWHM / FWTM 56.0° / 76.0°
Efficiency 87 %
Peak intensity 1.1 cd/lm
LEDs/each optic 1
Light colour White
Required components:
F15859_HEKLA-SOCKET-I

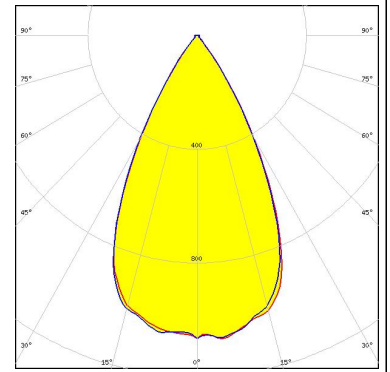

SAMSUNG

LED LC020T (Tunable white)
Ordering code CP19040_AMY-70-WW-C2
FWHM / FWTM 56.0° / 76.0°
Efficiency 86 %
Peak intensity 1.1 cd/lm
LEDs/each optic 1
Light colour White
Required components:
F15859_HEKLA-SOCKET-I

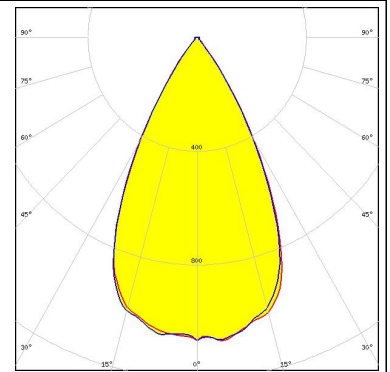

SAMSUNG

LED LC030C/040C G2
Ordering code CP19103_AMY-70-WW-B2
FWHM / FWTM 56.0° / 76.0°
Efficiency 88 %
Peak intensity 1.1 cd/lm
LEDs/each optic 1
Light colour White
Required components:
BJB: 47.360.1010

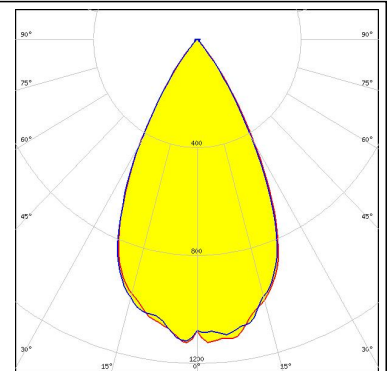

SEOUL SEMICONDUCTOR

LED MJT COB LES 14.5
Ordering code CP19040_AMY-70-WW-C2
FWHM / FWTM 58.0° / 80.0°
Efficiency 89 %
Peak intensity 1.1 cd/lm
LEDs/each optic 1
Light colour White
Required components:
F15859_HEKLA-SOCKET-I

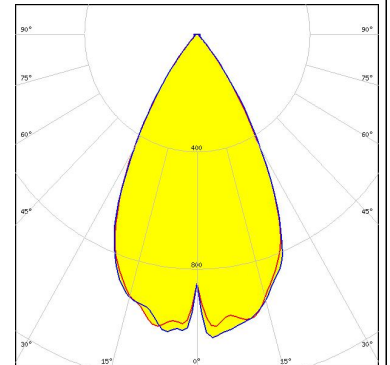

OPTICAL RESULTS (SIMULATED):

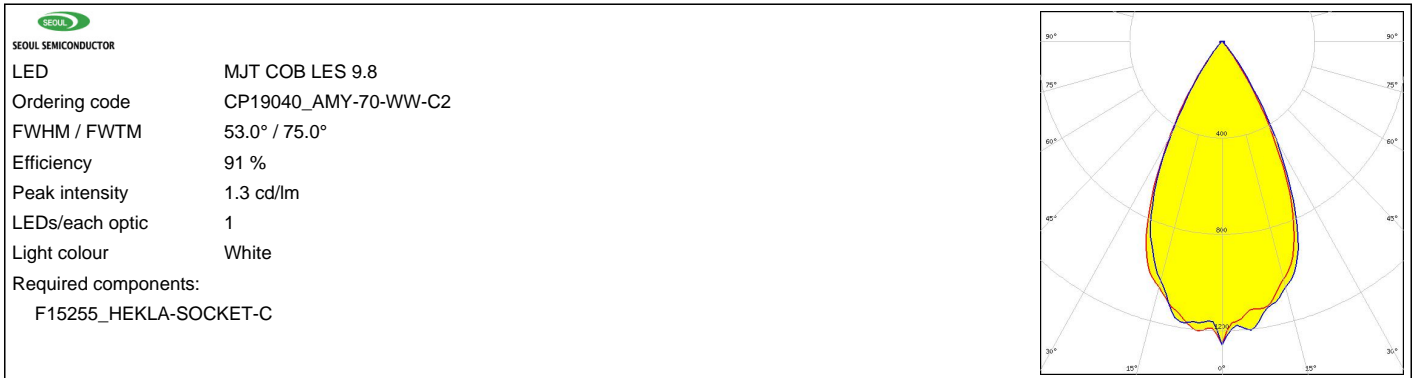

OPTICAL RESULTS (SIMULATED):

XICATO

LED	XOB 14.5 mm
Ordering code	CP19040_AMY-70-WW-C2
FWHM / FWTM	55.0° / 76.0°
Efficiency	79 %
Peak intensity	1 cd/lm
LEDs/each optic	1
Light colour	White
Required components:	
	F17438_HEKLA-G2-I

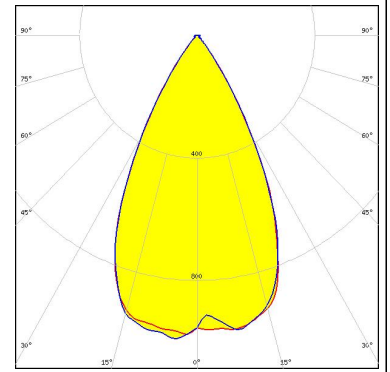

GENERAL INFORMATION:

NOTE: The typical beam angle will be changed by different color, chip size and chip position tolerance. The typical total beam angle is the full angle measured where the luminous intensity is half of the peak value.

Due to use of high power COB's with this product, special attention to proper thermal design is highly recommended. LEDiL has no liability for direct, indirect or consecutive damages arising from the LEDiL products being used outside of the recommended temperature range.

MATERIALS:

As part of our continuous research and improvement processes, and to ensure the best possible quality and availability of our products, LEDiL reserves the right to change material grades without notice.

PRODUCT DATA USER AGREEMENT AND DISCLAIMER:

The measured data in the provided downloadable LEDiL Product Datasheets and Mechanical 2D-Drawings is rounded and provided as reference for planning. LEDiL Oy's optical specifications have been verified by conducting performance testing of the products in accordance with the company's quality system. The reported data are averaged results of multiple measurements with typical variation. LEDiL Oy reserves the right to without prior notification make changes and improvements to its products.

LEDiL Oy assumes neither warranty, nor guarantee nor any other liability of any kind for the contents and correctness of the provided data. The provided data has been generated with highest diligence but the provided data may in reality not represent the complete possible variation range of all intrinsic parameters. Therefore, in certain cases a deviation from the provided data could occur.

LEDiL Oy reserves the right to undertake technical changes of its products without further notification which could lead to changes in the provided data. LEDiL Oy assumes no liability of any kind for the possible deviation from any provided data or any other damage resulting from the usage of the provided data.

The user agrees to this disclaimer and user agreement with the download or usage of the provided files.

LEDiL Oy

Joensuunkatu 13
FI-24240 SALO
Finland

LEDiL Inc.

228 West Page Street
Suite D
Sycamore IL 60178
USA

Ledil Optics Technology (Shenzhen) Co., Ltd.

405 , Block B
Casic Motor Building
Shenzhen 518057
P.R.CHINA

Local sales and technical support

[www.ledil.com/
where_to_buy](http://www.ledil.com/where_to_buy)

Shipping locations

Salo, Finland
Hong Kong, China

Distribution Partners

[www.ledil.com/
where_to_buy](http://www.ledil.com/where_to_buy)