

AMY-50-M

~24° medium beam

SPECIFICATION:

Dimensions	Ø 49.9 mm
Height	10.9 mm
Fastening	socket
ROHS compliant	yes ⓘ

MATERIALS:

Component	Type	Material	Colour	Finish
AMY-50-M	Single lens	PMMA	clear	
AMY-50-HLD2-C	Holder C	PC	black	
AMY-50-HLD2-B	Holder B	PC	black	
AMY-50-HLD2-C-WHT	Holder C	PC	white	
AMY-50-HLD2-B-WHT	Holder B	PC	white	



ORDERING INFORMATION:

Component	Qty in box	MOQ	MPQ	Box weight (kg)
C17687_AMY-50-M	690	120	30	9.5
Assembly				
CP19151_AMY-50-M-B2-WHT	510	120	30	8.8
CP19142_AMY-50-M-C2-WHT	510	120	30	8.4
CP19133_AMY-50-M-B2	510	120	30	8.8
CP19124_AMY-50-M-C2	510	120	30	8.4

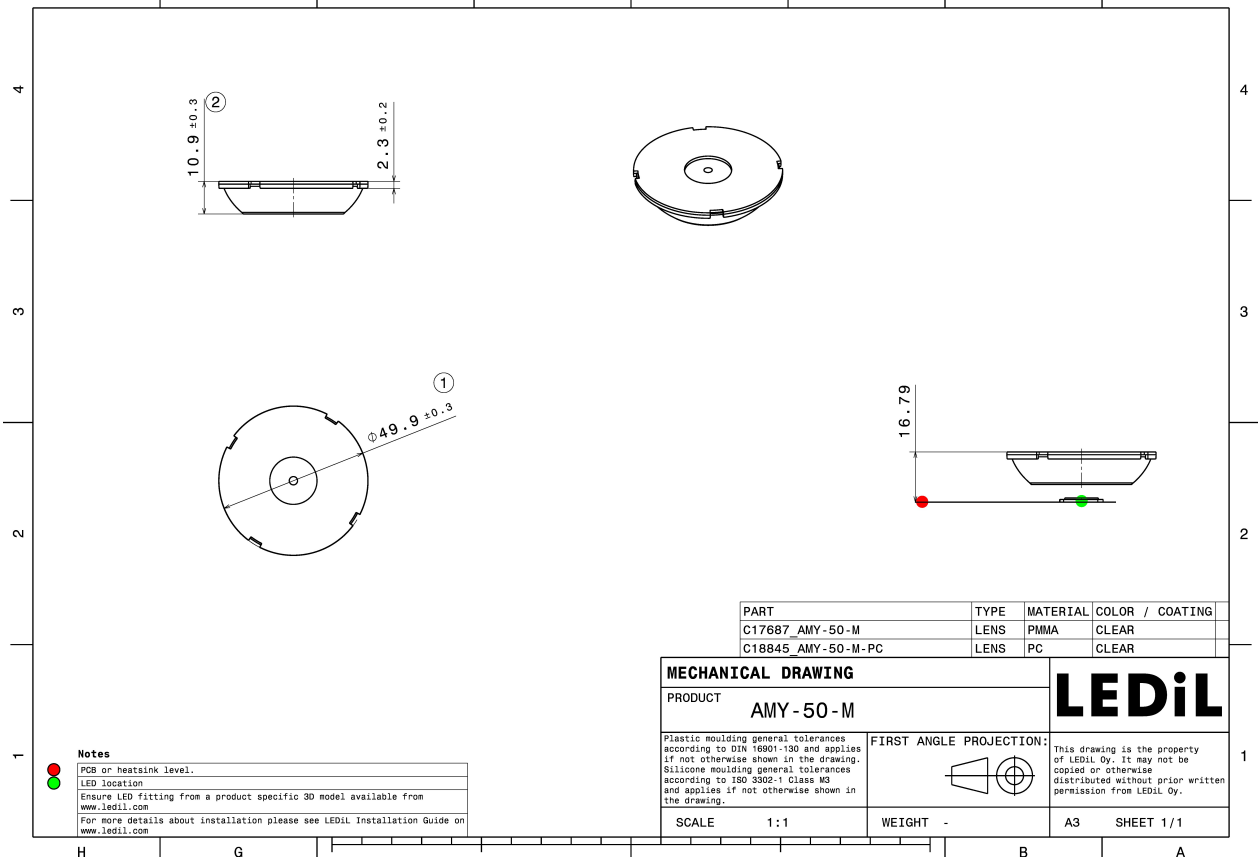
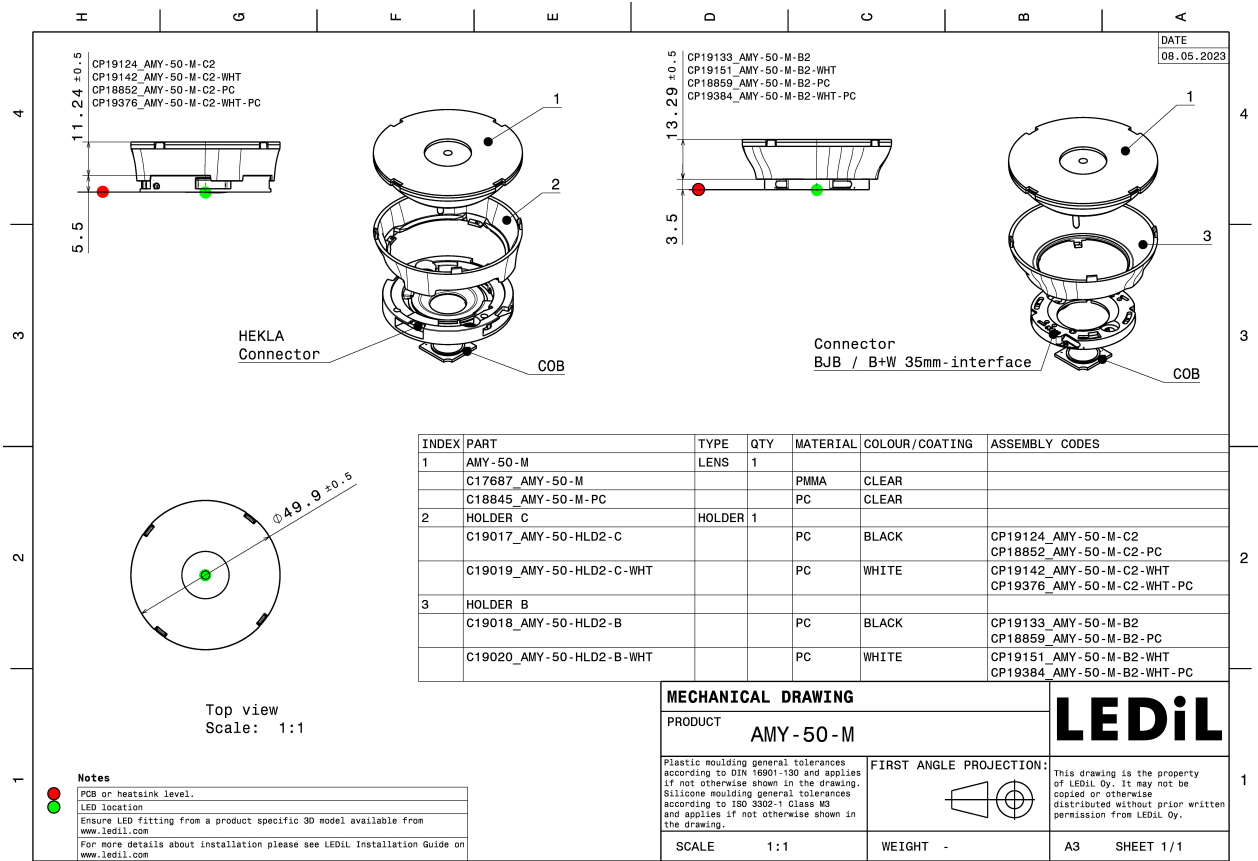

See also our general installation guide: www.ledil.com/installation_guide

OPTICAL RESULTS (MEASURED):

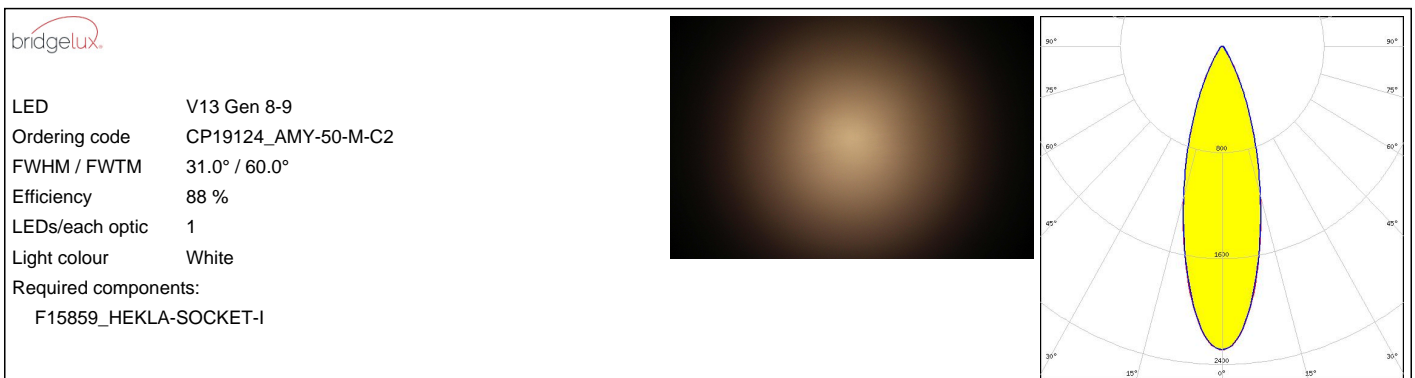

OPTICAL RESULTS (MEASURED):

bridgelux.

LED V6 HD Gen 7
 Ordering code CP19124_AMY-50-M-C2
 FWHM / FWTM 24.0° / 43.0°
 Efficiency 91 %
 LEDs/each optic 1
 Light colour White
 Required components:
 F15255_HEKLA-SOCKET-C





bridgelux.

LED V8 Gen 8-9
 Ordering code CP19124_AMY-50-M-C2
 FWHM / FWTM 25.0° / 46.0°
 Efficiency 92 %
 LEDs/each optic 1
 Light colour White
 Required components:
 F15253_HEKLA-SOCKET-A

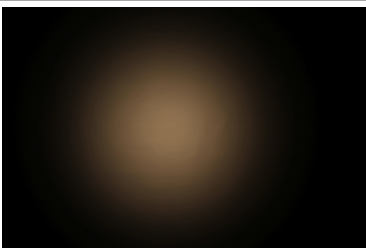

bridgelux.

LED V9 HD Gen7
 Ordering code CP19124_AMY-50-M-C2
 FWHM / FWTM 25.0° / 46.0°
 Efficiency 90 %
 LEDs/each optic 1
 Light colour White
 Required components:
 F15859_HEKLA-SOCKET-I



bridgelux.

LED VERO10
 Ordering code CP19124_AMY-50-M-C2
 FWHM / FWTM 25.0° / 47.0°
 Efficiency 90 %
 LEDs/each optic 1
 Light colour White
 Required components:
 F15616_HEKLA-SOCKET-F



OPTICAL RESULTS (MEASURED):

			
<p>LED Vesta DTW 13mm (21W)</p> <p>Ordering code CP19124_AMY-50-M-C2</p> <p>FWHM / FWTM 30.0° / 57.0°</p> <p>Efficiency 86 %</p> <p>LEDs/each optic 1</p> <p>Light colour White</p> <p>Required components: C16142_HEKLA-SOCKET-K Bender Wirth: 491 Typ L8</p>			

			
<p>LED Vesta DTW 15mm (33W)</p> <p>Ordering code CP19124_AMY-50-M-C2</p> <p>FWHM / FWTM 29.0° / 58.0°</p> <p>Efficiency 86 %</p> <p>LEDs/each optic 1</p> <p>Light colour White</p> <p>Required components: C16142_HEKLA-SOCKET-K Bender Wirth: 491 Typ L8</p>			

			
<p>LED Vesta TW 13mm (18W) DP</p> <p>Ordering code CP19124_AMY-50-M-C2</p> <p>FWHM / FWTM 29.0° / 58.0°</p> <p>Efficiency 87 %</p> <p>LEDs/each optic 1</p> <p>Light colour White</p> <p>Required components: C16142_HEKLA-SOCKET-K Bender Wirth: 492 Typ L8</p>			

			
<p>LED Vesta TW 15mm DP</p> <p>Ordering code CP19124_AMY-50-M-C2</p> <p>FWHM / FWTM 32.0° / 63.0°</p> <p>Efficiency 86 %</p> <p>LEDs/each optic 1</p> <p>Light colour White</p> <p>Required components: C16142_HEKLA-SOCKET-K Bender Wirth: 482 Typ L8</p>			

OPTICAL RESULTS (MEASURED):



OPTICAL RESULTS (MEASURED):

CITIZEN

LED CLL02x/CLU02x (LES10)
Ordering code CP19133_AMY-50-M-B2
FWHM / FWTM 26.0° / 49.0°
Efficiency 90 %
LEDs/each optic 1
Light colour White
Required components:
Green Gems: GH27d

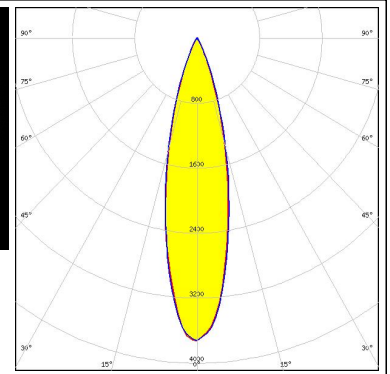

CITIZEN

LED CLL02x/CLU02x (LES10)
Ordering code CP19142_AMY-50-M-C2-WHT
FWHM / FWTM 26.0° / 47.0°
Efficiency 96 %
Peak intensity 3.6 cd/lm
LEDs/each optic 1
Light colour White
Required components:
F17435_HEKLA-G2-C

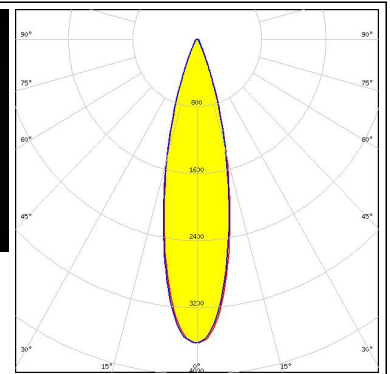
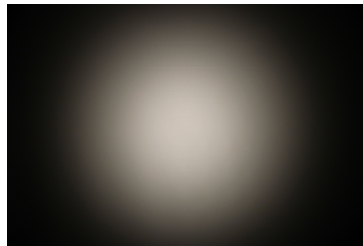

CITIZEN

LED CLL03x/CLU03x
Ordering code CP19124_AMY-50-M-C2
FWHM / FWTM 29.0° / 58.0°
Efficiency 87 %
LEDs/each optic 1
Light colour White
Required components:
F17438_HEKLA-G2-I

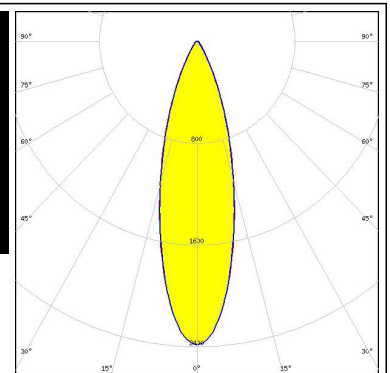
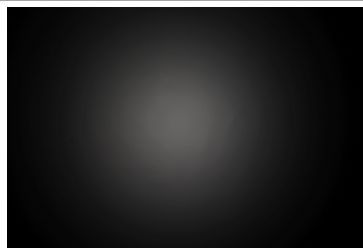

CITIZEN

LED CLU700/701/702/703
Ordering code CP19124_AMY-50-M-C2
FWHM / FWTM 24.0° / 43.0°
Efficiency 90 %
LEDs/each optic 1
Light colour White
Required components:
F17435_HEKLA-G2-C

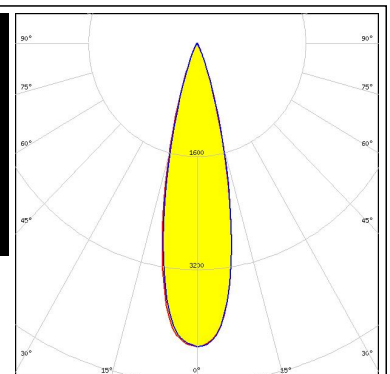
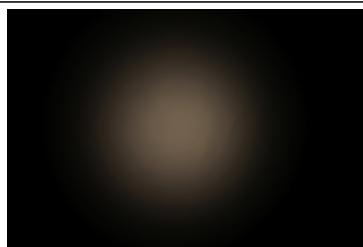

OPTICAL RESULTS (MEASURED):

CITIZEN

LED CLU7A2/7A3
Ordering code CP19124_AMY-50-M-C2
FWHM / FWTM 24.0° / 40.0°
Efficiency 90 %
LEDs/each optic 1
Light colour White
Required components:
F17435_HEKLA-G2-C

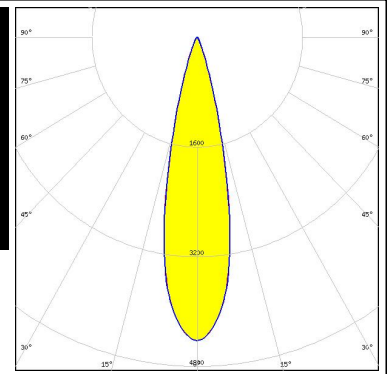

CITIZEN

LED CLU7B2
Ordering code CP19124_AMY-50-M-C2
FWHM / FWTM 24.0° / 39.0°
Efficiency 91 %
LEDs/each optic 1
Light colour White
Required components:
F17435_HEKLA-G2-C

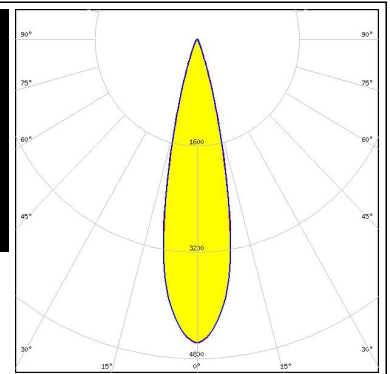
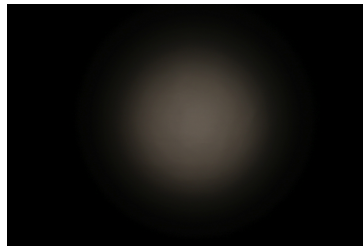

CITIZEN

LED CLU7L3
Ordering code CP19133_AMY-50-M-B2
FWHM / FWTM 24.0° / 39.0°
Efficiency 93 %
LEDs/each optic 1
Light colour White
Required components:
Bender Wirth: 667a Bayonet35

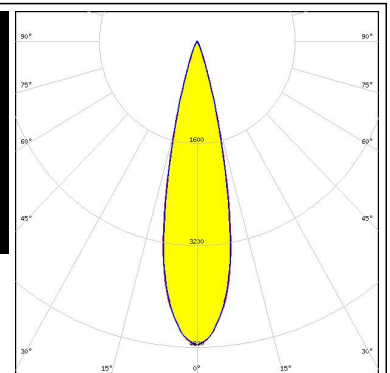
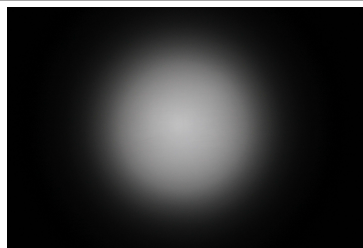

CITIZEN

LED CLU7S3
Ordering code CP19133_AMY-50-M-B2
FWHM / FWTM 24.0° / 40.0°
Efficiency 91 %
LEDs/each optic 1
Light colour White
Required components:
Bender Wirth: 667a Bayonet35

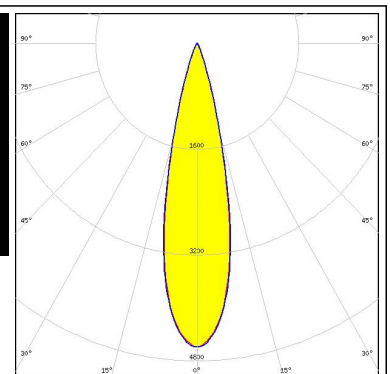

OPTICAL RESULTS (MEASURED):



LED CMA1516
Ordering code CP19124_AMY-50-M-C2
FWHM / FWTM 25.0° / 47.0°
Efficiency 90 %
LEDs/each optic 1
Light colour White
Required components:
F17436_HEKLA-G2-D

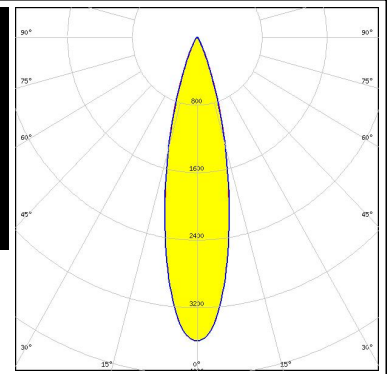
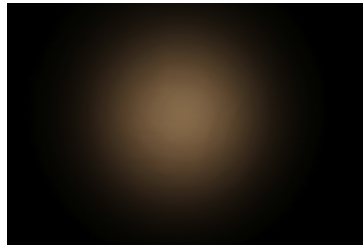

LED CMA1825
Ordering code CP19124_AMY-50-M-C2
FWHM / FWTM 27.0° / 54.0°
Efficiency 89 %
LEDs/each optic 1
Light colour White
Required components:
F15254_HEKLA-SOCKET-B

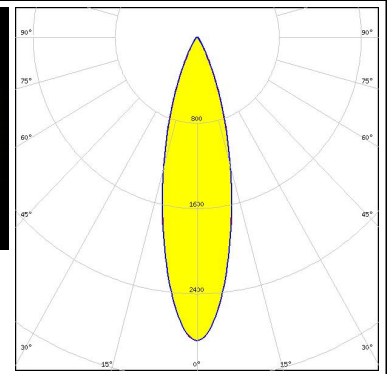
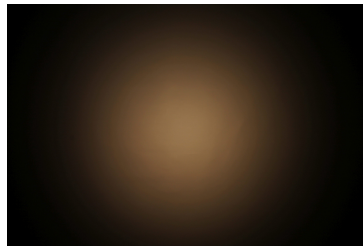

LED CMT14xx
Ordering code CP19124_AMY-50-M-C2
FWHM / FWTM 25.0° / 48.0°
Efficiency 89 %
LEDs/each optic 1
Light colour White
Required components:
F17435_HEKLA-G2-C

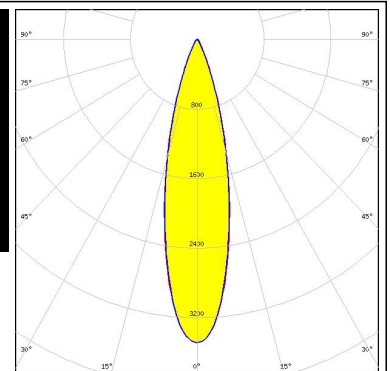
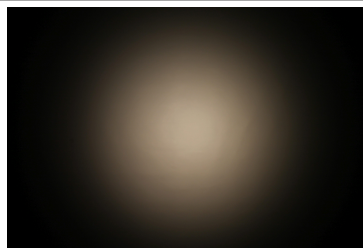

LED CMT19xx
Ordering code CP19124_AMY-50-M-C2
FWHM / FWTM 29.0° / 58.0°
Efficiency 87 %
LEDs/each optic 1
Light colour White
Required components:
F17438_HEKLA-G2-I

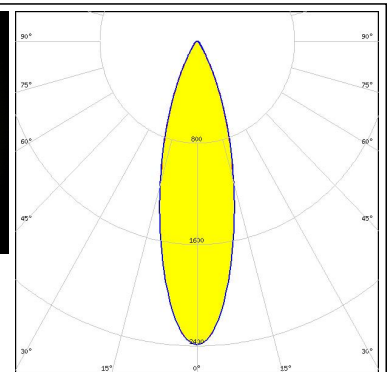
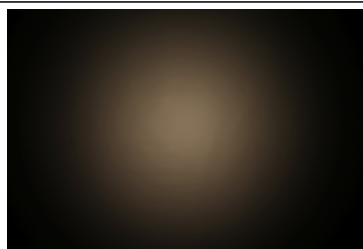

OPTICAL RESULTS (MEASURED):



LED CXA/B 13xx
 Ordering code CP19124_AMY-50-M-C2
 FWHM / FWTM 24.0° / 42.0°
 Efficiency 91 %
 LEDs/each optic 1
 Light colour White
 Required components:
 F17439_HEKLA-G2-J

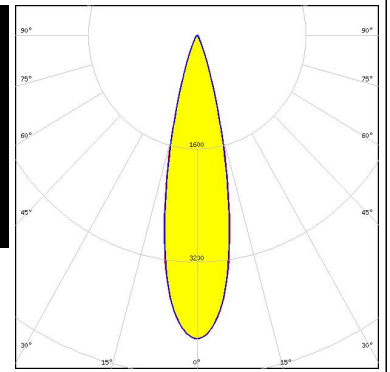
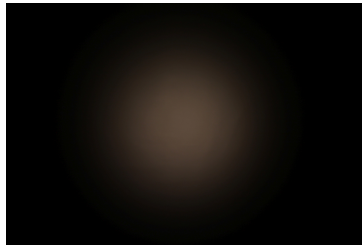

LED CXA/B 15xx
 Ordering code CP19124_AMY-50-M-C2
 FWHM / FWTM 25.0° / 46.0°
 Efficiency 90 %
 LEDs/each optic 1
 Light colour White
 Required components:
 F17436_HEKLA-G2-D

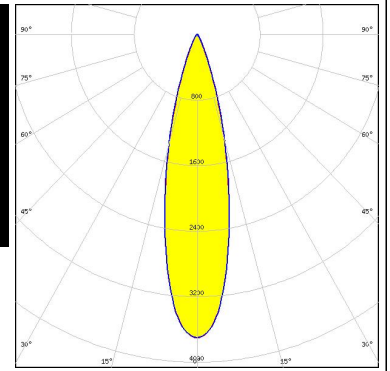

LED LEDiM/C6
 Ordering code CP19124_AMY-50-M-C2
 FWHM / FWTM 26.0° / 46.0°
 Efficiency 90 %
 LEDs/each optic 1
 Light colour White
 Required components:
 F17438_HEKLA-G2-I

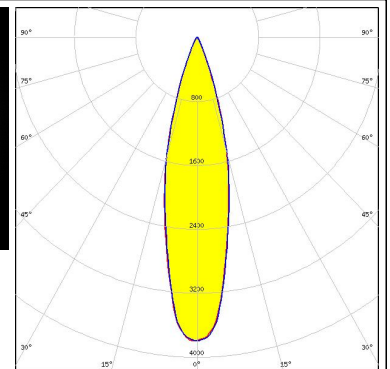

LED LUXEON 7070
 Ordering code CP19133_AMY-50-M-B2
 FWHM / FWTM 25.0° / 44.0°
 Efficiency 92 %
 LEDs/each optic 1
 Light colour White
 Required components:
 Bender Wirth: 634a Bayonet35L

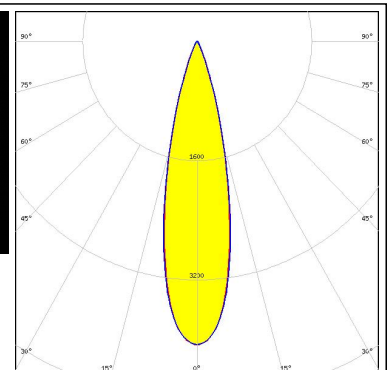
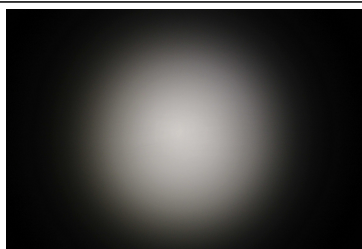

OPTICAL RESULTS (MEASURED):



LED LUXEON CoB 1202/1203
Ordering code CP19124_AMY-50-M-C2
FWHM / FWTM 25.0° / 46.0°
Efficiency 89 %
LEDs/each optic 1
Light colour White
Required components:
 F17437_HEKLA-G2-H

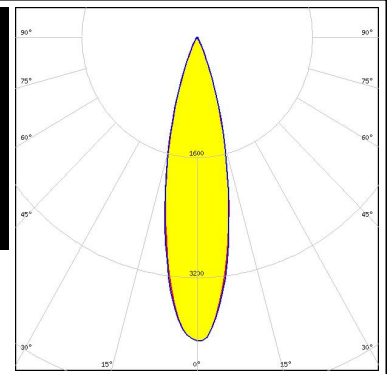
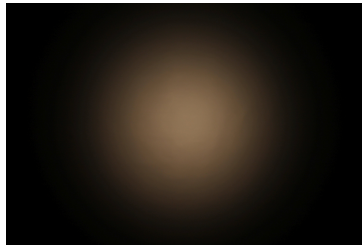

LED LUXEON CoB 1204HD
Ordering code CP19124_AMY-50-M-C2
FWHM / FWTM 25.0° / 47.0°
Efficiency 89 %
LEDs/each optic 1
Light colour White
Required components:
 F17437_HEKLA-G2-H

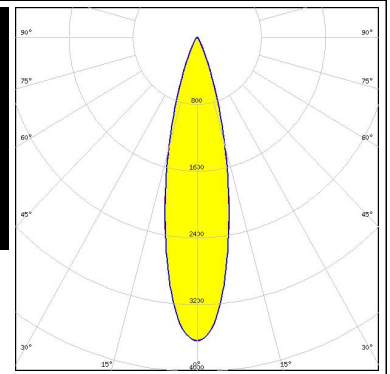

LED LUXEON CoB M02/M03
Ordering code CP19124_AMY-50-M-C2
FWHM / FWTM 25.0° / 47.0°
Efficiency 90 %
LEDs/each optic 1
Light colour White
Required components:
 F17436_HEKLA-G2-D

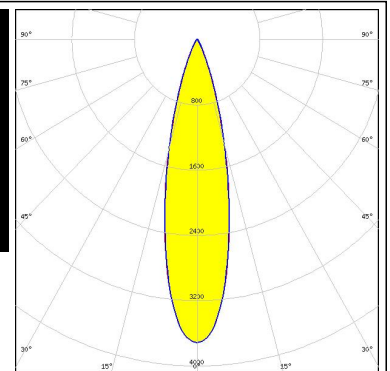
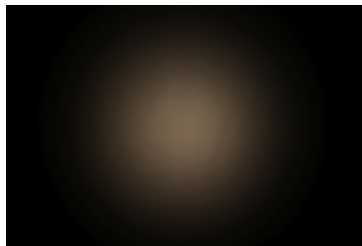

LED LUXEON CoB S01
Ordering code CP19124_AMY-50-M-C2
FWHM / FWTM 24.0° / 42.0°
Efficiency 91 %
LEDs/each optic 1
Light colour White
Required components:
 F17439_HEKLA-G2-J

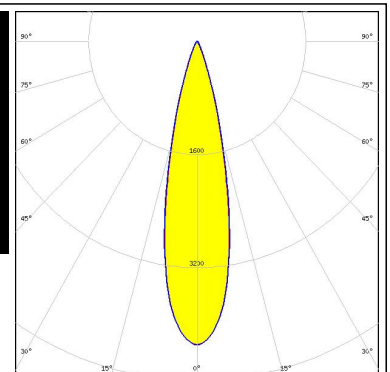
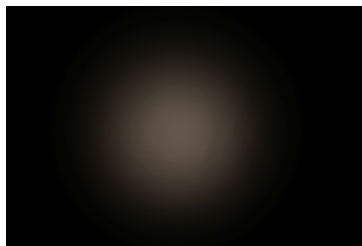

OPTICAL RESULTS (MEASURED):



LED LUXEON Fusion 12-up (20x24)
Ordering code CP19124_AMY-50-M-C2
FWHM / FWTM 25.0° / 47.0°
Efficiency 83 %
LEDs/each optic 1
Light colour White
Required components:
 C16142_HEKLA-SOCKET-K
 F18158_HEKLA-RZ-LENS
 Bender Wirth: 442 Typ L8

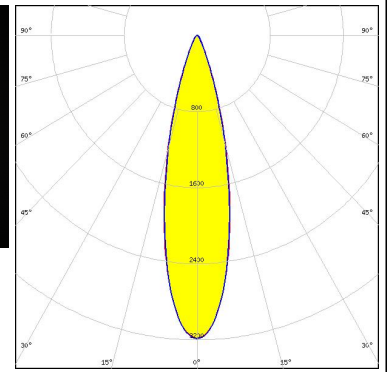
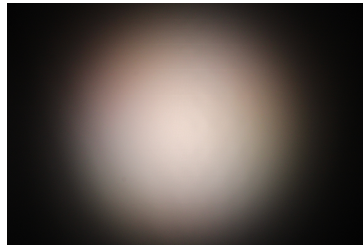

LED LUXEON Fusion 21-up (20x24)
Ordering code CP19124_AMY-50-M-C2
FWHM / FWTM 26.0° / 48.0°
Efficiency 82 %
LEDs/each optic 1
Light colour White
Required components:
 C16142_HEKLA-SOCKET-K
 F18158_HEKLA-RZ-LENS
 Bender Wirth: 442 Typ L8

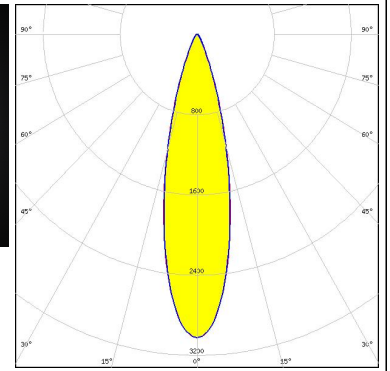
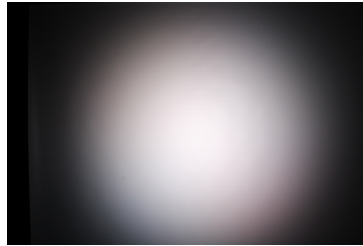

LED LUXEON Fusion 27-up (20x24)
Ordering code CP19124_AMY-50-M-C2
FWHM / FWTM 29.0° / 55.0°
Efficiency 80 %
LEDs/each optic 1
Light colour White
Required components:
 C16142_HEKLA-SOCKET-K
 F18158_HEKLA-RZ-LENS
 Bender Wirth: 442 Typ L8

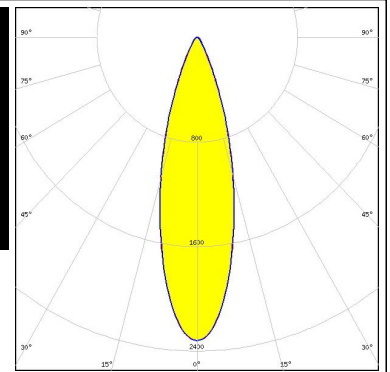

LED CTM-14 (Tunable White) Gen2
Ordering code CP19124_AMY-50-M-C2
FWHM / FWTM 29.5° / 57.0°
Efficiency 86 %
LEDs/each optic 1
Light colour White
Required components:
 C16142_HEKLA-SOCKET-K
 Bender Wirth: 442 Typ L8

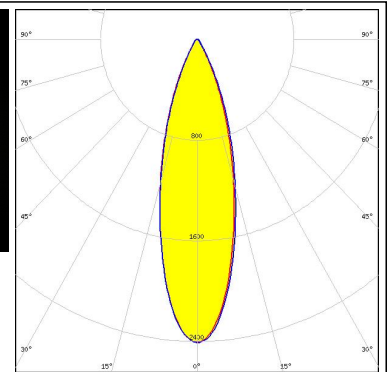
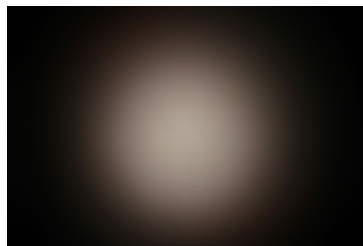

OPTICAL RESULTS (MEASURED):



LED CTM-9 (Tunable White)
Ordering code CP19133_AMY-50-M-B2
FWHM / FWTM 27.0° / 50.0°
Efficiency 89 %
LEDs/each optic 1
Light colour White
Required components:
Bender Wirth: 495 Typ B35L

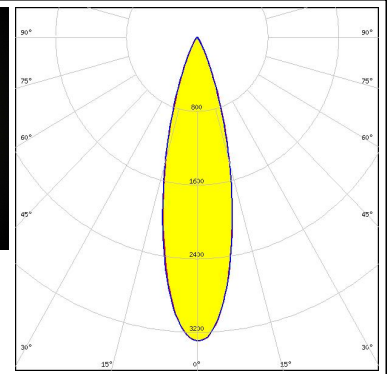
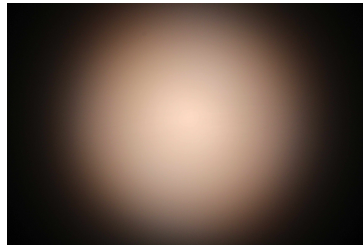

LED CXM-3
Ordering code CP19124_AMY-50-M-C2
FWHM / FWTM 24.0° / 40.0°
Efficiency 91 %
LEDs/each optic 1
Light colour White
Required components:
F17435_HEKLA-G2-C

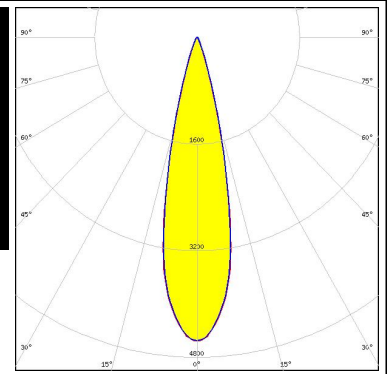

LED CXM-4
Ordering code CP19124_AMY-50-M-C2
FWHM / FWTM 24.0° / 40.0°
Efficiency 91 %
LEDs/each optic 1
Light colour White
Required components:
F17435_HEKLA-G2-C

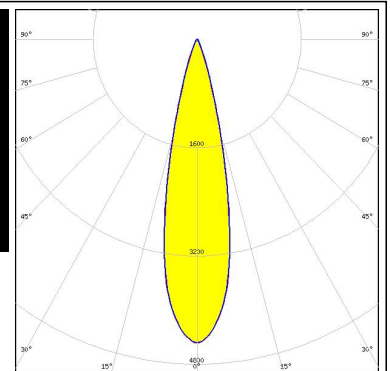
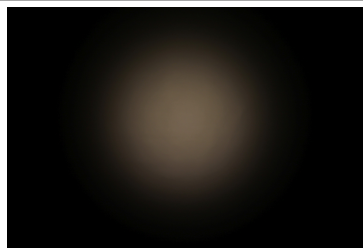

LED COB L-Type (LES 11)
Ordering code CP19124_AMY-50-M-C2
FWHM / FWTM 27.0° / 52.0°
Efficiency 88 %
LEDs/each optic 1
Light colour White
Required components:
F17437_HEKLA-G2-H

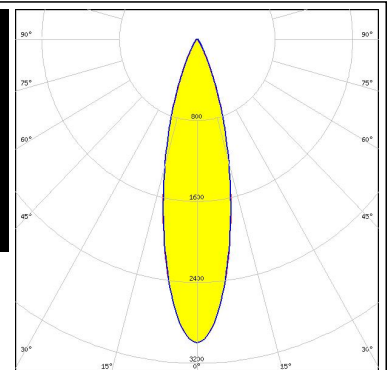
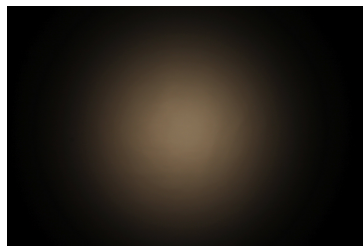

OPTICAL RESULTS (MEASURED):



LED COB L-Type (LES 9)
Ordering code CP19124_AMY-50-M-C2
FWHM / FWTM 25.0° / 46.0°
Efficiency 89 %
LEDs/each optic 1
Light colour White
Required components:
F17437_HEKLA-G2-H

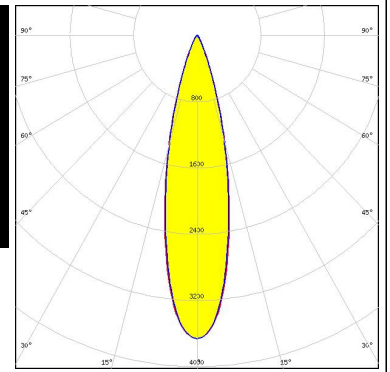
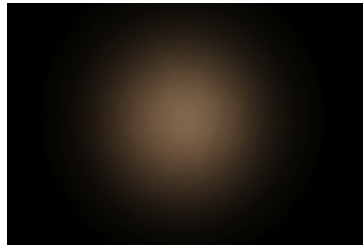

LED COB S-Type (LES 7)
Ordering code CP19124_AMY-50-M-C2
FWHM / FWTM 24.0° / 44.0°
Efficiency 91 %
LEDs/each optic 1
Light colour White
Required components:
F15848_HEKLA-SOCKET-G

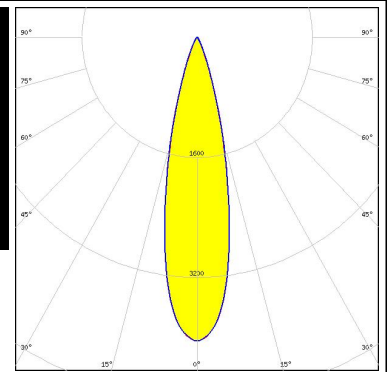
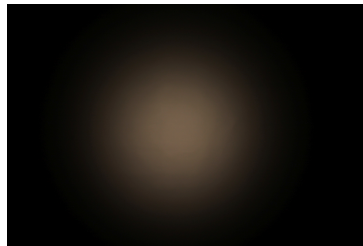

LED Fortimo SLM L09 CoB
Ordering code CP19124_AMY-50-M-C2
FWHM / FWTM 25.0° / 47.0°
Efficiency 89 %
LEDs/each optic 1
Light colour White
Required components:
F17437_HEKLA-G2-H

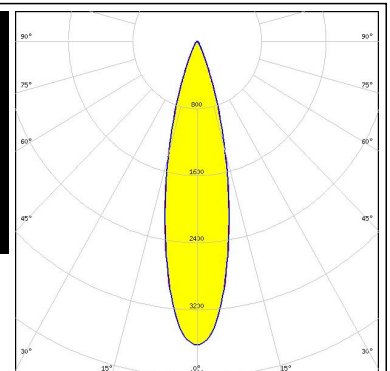
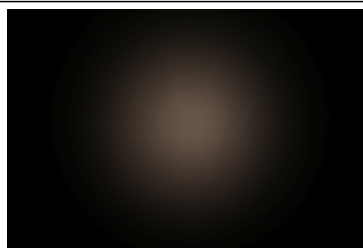

LED LC003D / LC006D / LC009D / LC013D
Ordering code CP19124_AMY-50-M-C2
FWHM / FWTM 25.0° / 48.0°
Efficiency 89 %
LEDs/each optic 1
Light colour White
Required components:
F17435_HEKLA-G2-C

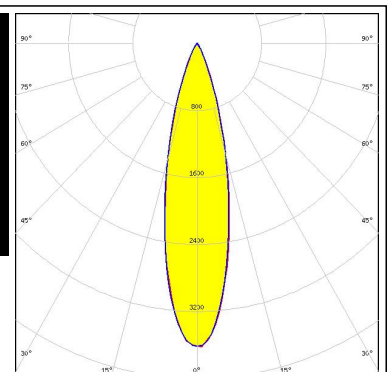
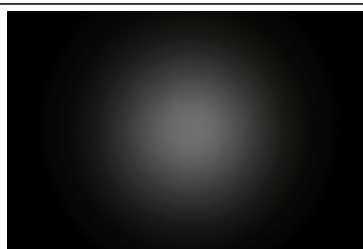

OPTICAL RESULTS (MEASURED):

SAMSUNG

LED LC016D / LC019D / LC026D / LC033D
 Ordering code CP19124_AMY-50-M-C2
 FWHM / FWTM 31.0° / 62.0°
 Efficiency 87 %
 LEDs/each optic 1
 Light colour White
 Required components:
 F17438_HEKLA-G2-I

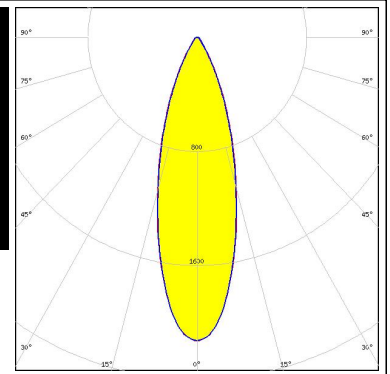
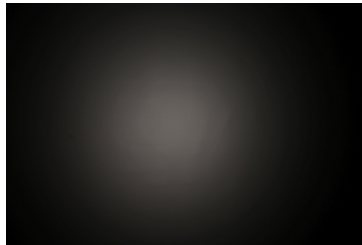

SAMSUNG

LED LC030C/040C G2
 Ordering code CP19124_AMY-50-M-C2
 FWHM / FWTM 26.0° / 52.0°
 Efficiency 88 %
 LEDs/each optic 1
 Light colour White
 Required components:
 F17438_HEKLA-G2-I

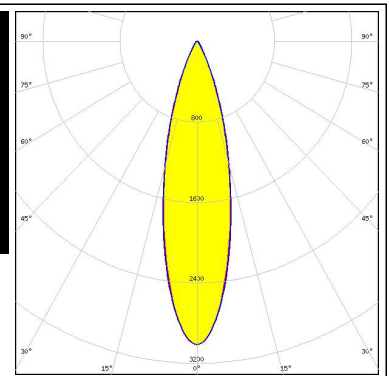
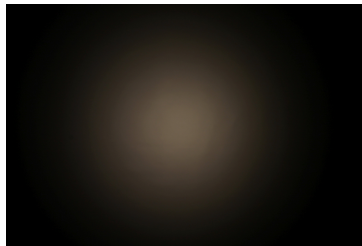

LED MJT COB LES 14.5
 Ordering code CP19124_AMY-50-M-C2
 FWHM / FWTM 30.0° / 60.0°
 Efficiency 87 %
 LEDs/each optic 1
 Light colour White
 Required components:
 F17438_HEKLA-G2-I

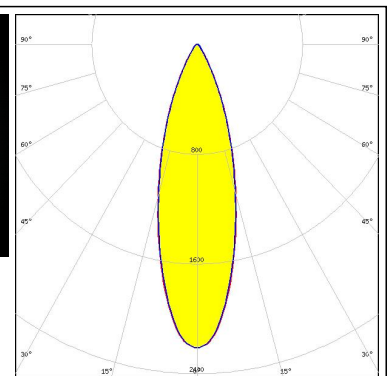
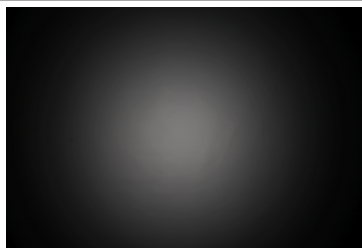

LED MJT COB LES 6
 Ordering code CP19124_AMY-50-M-C2
 FWHM / FWTM 24.0° / 42.0°
 Efficiency 91 %
 LEDs/each optic 1
 Light colour White
 Required components:
 F17435_HEKLA-G2-C

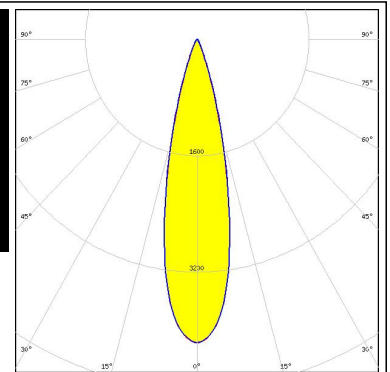
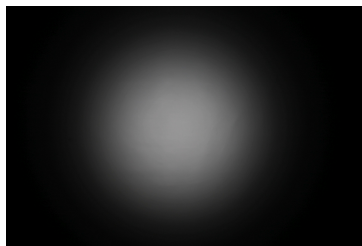

OPTICAL RESULTS (MEASURED):

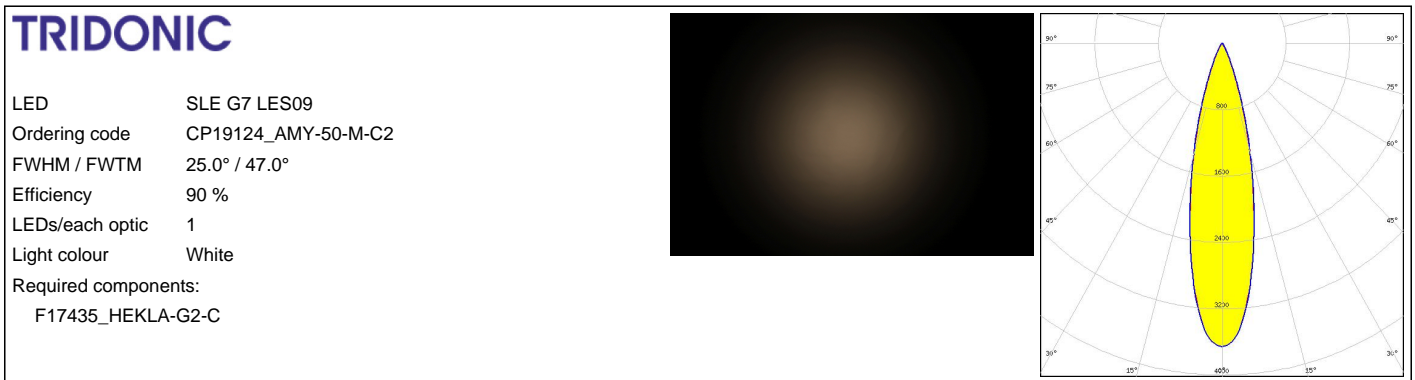
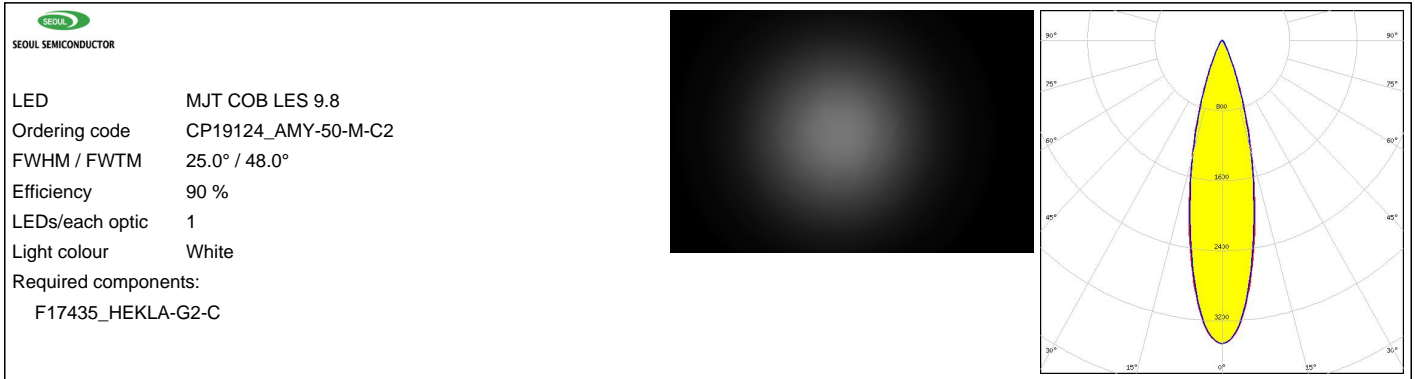

OPTICAL RESULTS (SIMULATED):

bridgelux

LED V10 Gen 8-9
 Ordering code CP19133_AMY-50-M-B2
 FWHM / FWTM 24.0° / 47.0°
 Efficiency 90 %
 Peak intensity 3.9 cd/lm
 LEDs/each optic 1
 Light colour White
 Required components:
 BJB: 47.360.1020

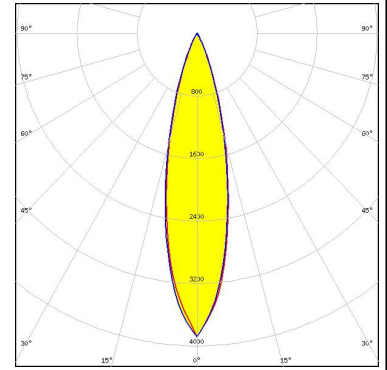

bridgelux

LED V3 HD Gen 8
 Ordering code CP19124_AMY-50-M-C2
 FWHM / FWTM 26.0° / 40.0°
 Efficiency 94 %
 Peak intensity 4.8 cd/lm
 LEDs/each optic 1
 Light colour White
 Required components:
 F15253_HEKLA-SOCKET-A

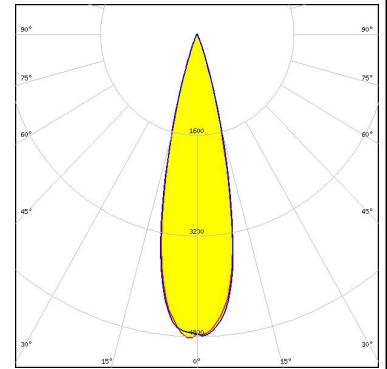

bridgelux

LED V3 HD Gen 8 FC
 Ordering code CP19124_AMY-50-M-C2
 FWHM / FWTM 26.0° / 40.0°
 Efficiency 94 %
 Peak intensity 4.6 cd/lm
 LEDs/each optic 1
 Light colour White
 Required components:
 F15255_HEKLA-SOCKET-C

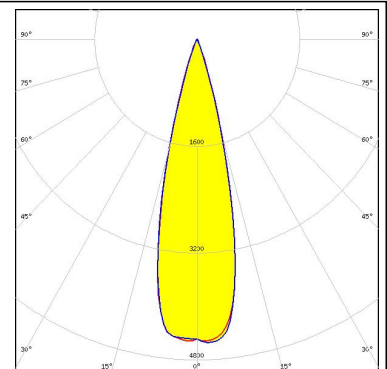

bridgelux

LED V4 HD Gen 7
 Ordering code CP19124_AMY-50-M-C2
 FWHM / FWTM 26.1° / 42.2°
 Efficiency 92 %
 Peak intensity 4.4 cd/lm
 LEDs/each optic 1
 Light colour White
 Required components:
 F15255_HEKLA-SOCKET-C

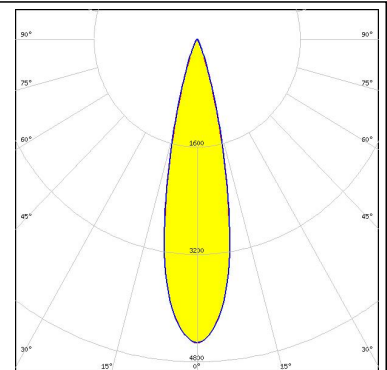

OPTICAL RESULTS (SIMULATED):

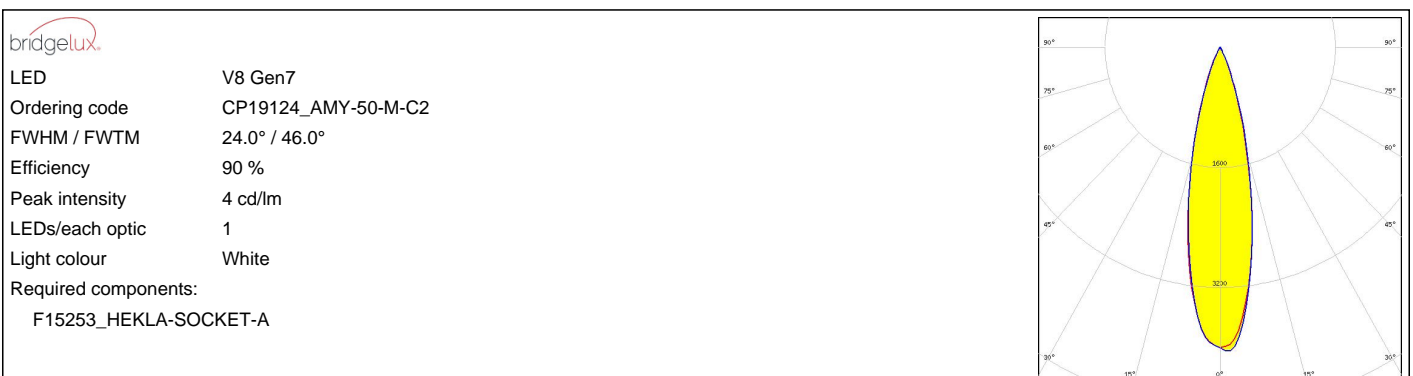
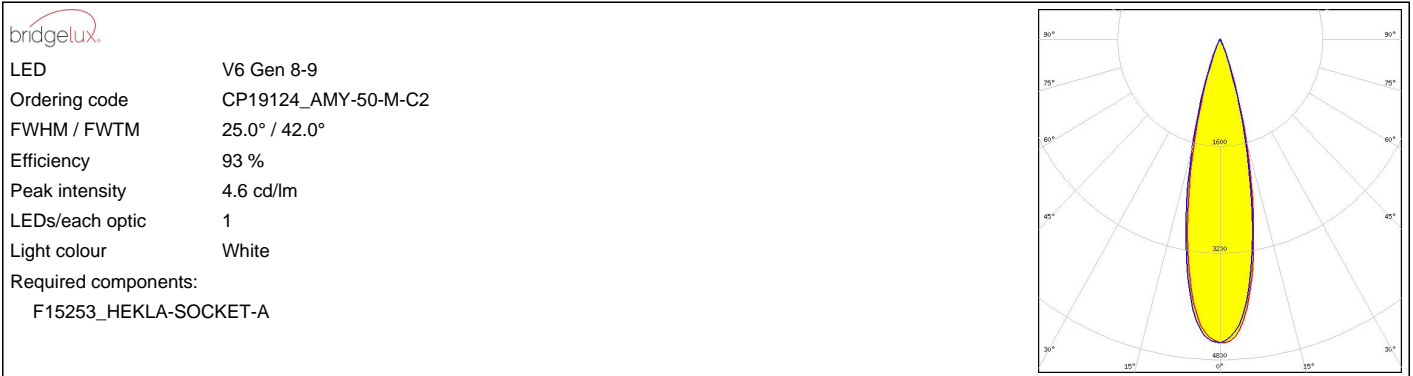

OPTICAL RESULTS (SIMULATED):

bridgelux

LED V9 HD Gen 8
 Ordering code CP19124_AMY-50-M-C2
 FWHM / FWTM 24.0° / 45.0°
 Efficiency 92 %
 Peak intensity 4.3 cd/lm
 LEDs/each optic 1
 Light colour White
 Required components:
 F15859_HEKLA-SOCKET-I

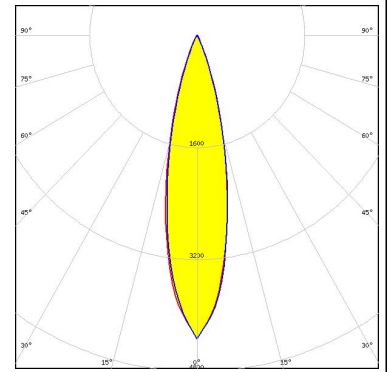

bridgelux

LED VERO13
 Ordering code CP19124_AMY-50-M-C2
 FWHM / FWTM 29.0° / 56.0°
 Efficiency 91 %
 Peak intensity 2.9 cd/lm
 LEDs/each optic 1
 Light colour White
 Required components:
 C16142_HEKLA-SOCKET-K

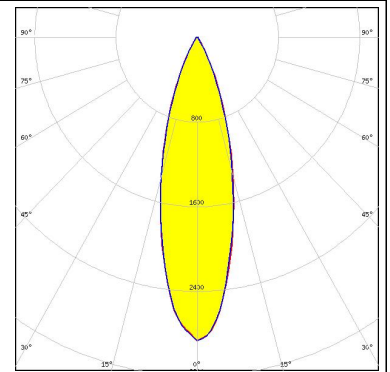

bridgelux

LED Vesta DTW 6mm
 Ordering code CP19124_AMY-50-M-C2
 FWHM / FWTM 24.0° / 43.0°
 Efficiency 93 %
 Peak intensity 4.5 cd/lm
 LEDs/each optic 1
 Light colour White
 Required components:
 Bender Wirth: 652b Hekla

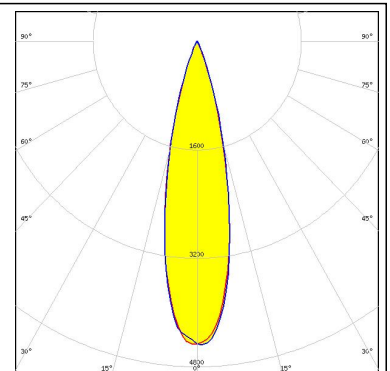

bridgelux

LED Vesta DTW 9mm (4W/6W/12W)
 Ordering code CP19124_AMY-50-M-C2
 FWHM / FWTM 24.0° / 44.0°
 Efficiency 91 %
 Peak intensity 4.3 cd/lm
 LEDs/each optic 1
 Light colour White
 Required components:
 Bender Wirth: 652b Hekla

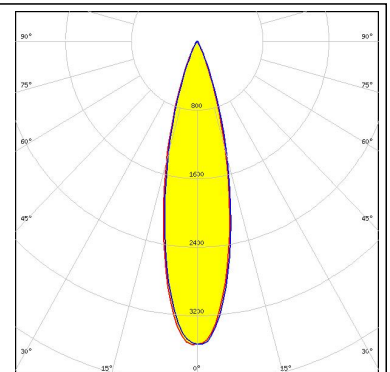

OPTICAL RESULTS (SIMULATED):

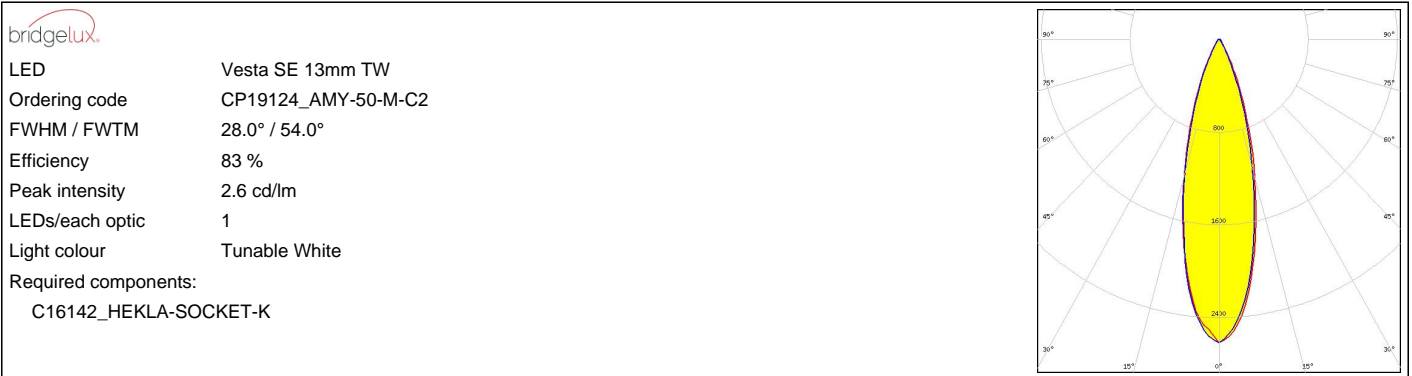

OPTICAL RESULTS (SIMULATED):

CITIZEN

LED CLU700/701/702/703
Ordering code CP19124_AMY-50-M-C2
FWHM / FWTM 26.0° / 42.0°
Efficiency 91 %
Peak intensity 4.3 cd/lm
LEDs/each optic 1
Light colour White
Required components:
F15255_HEKLA-SOCKET-C

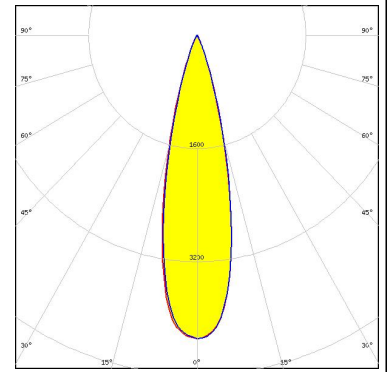

CITIZEN

LED CLU700/701/702/703
Ordering code CP19133_AMY-50-M-B2
FWHM / FWTM 25.1° / 42.2°
Efficiency 92 %
Peak intensity 4.3 cd/lm
LEDs/each optic 1
Light colour White
Required components:
BJB: 47.360.1020

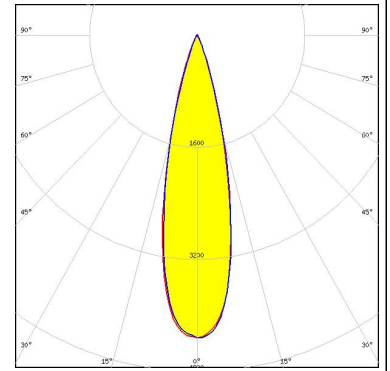

CITIZEN

LED CLU710/711
Ordering code CP19133_AMY-50-M-B2
FWHM / FWTM 24.0° / 46.0°
Efficiency 91 %
Peak intensity 4 cd/lm
LEDs/each optic 1
Light colour White
Required components:
BJB: 47.360.1010

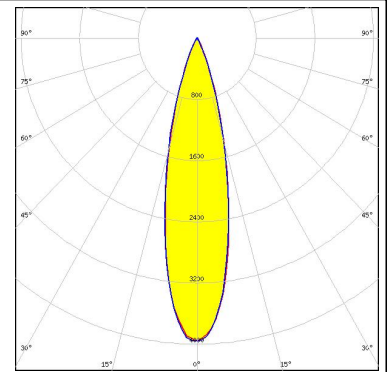

CITIZEN

LED CLU712/713
Ordering code CP19124_AMY-50-M-C2
FWHM / FWTM 24.0° / 46.0°
Efficiency 90 %
Peak intensity 4.2 cd/lm
LEDs/each optic 1
Light colour White
Required components:
F17438_HEKLA-G2-I

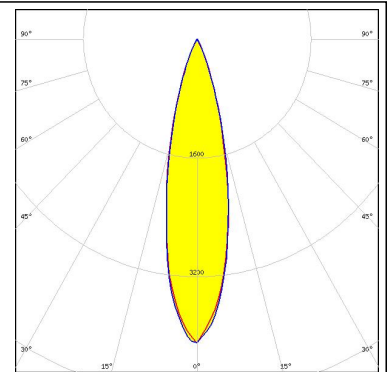

OPTICAL RESULTS (SIMULATED):



LED CMA1306
Ordering code CP19124_AMY-50-M-C2
FWHM / FWTM 24.0° / 43.0°
Efficiency 91 %
Peak intensity 4.5 cd/lm
LEDs/each optic 1
Light colour White
Required components:
F17439_HEKLA-G2-J

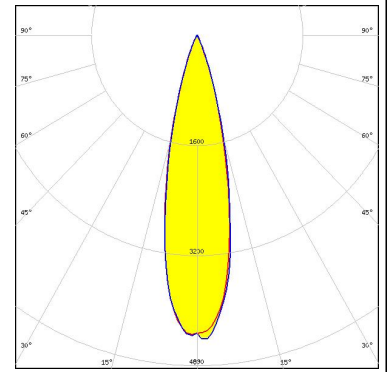

LED CMU10xx
Ordering code CP19133_AMY-50-M-B2
FWHM / FWTM 24.0° / 48.0°
Efficiency 90 %
Peak intensity 3.9 cd/lm
LEDs/each optic 1
Light colour White
Required components:
BJB: 47.360.1020

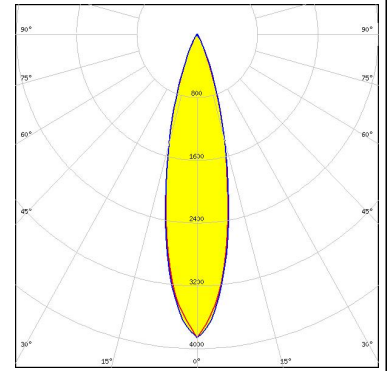

LED LUXEON CX Plus CoB L08 (Gen2)
Ordering code CP19124_AMY-50-M-C2
FWHM / FWTM 30.0° / 59.0°
Efficiency 89 %
Peak intensity 2.5 cd/lm
LEDs/each optic 1
Light colour White
Required components:
Bender Wirth: 637a Hekla

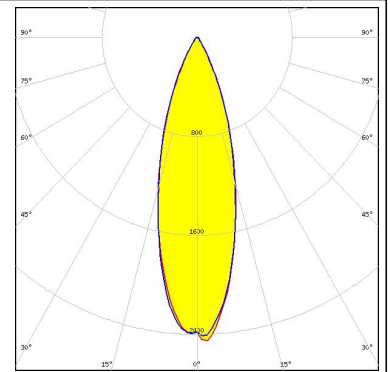

LED LUXEON CoB 1202/1203
Ordering code CP19124_AMY-50-M-C2
FWHM / FWTM 24.1° / 46.3°
Efficiency 89 %
Peak intensity 3.9 cd/lm
LEDs/each optic 1
Light colour White
Required components:
F15858_HEKLA-SOCKET-H

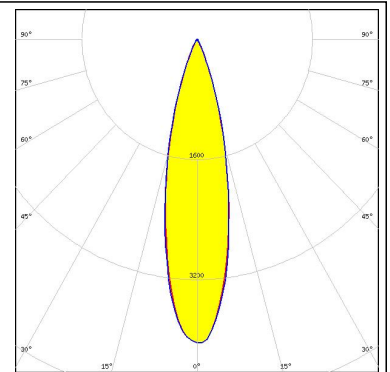

OPTICAL RESULTS (SIMULATED):

LUMILEDS

LED LUXEON CoB 1202/1203
Ordering code CP19124_AMY-50-M-C2
FWHM / FWTM 24.0° / 46.0°
Efficiency 92 %
Peak intensity 4.1 cd/lm
LEDs/each optic 1
Light colour White
Required components:
F15858_HEKLA-SOCKET-H

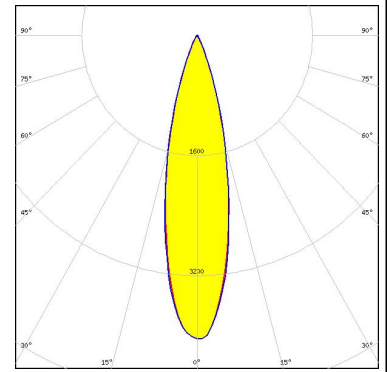

LUMILEDS

LED LUXEON CoB 1204/1205
Ordering code CP19124_AMY-50-M-C2
FWHM / FWTM 27.0° / 54.0°
Efficiency 90 %
Peak intensity 3 cd/lm
LEDs/each optic 1
Light colour White
Required components:
Bender Wirth: 632a Hekla XL

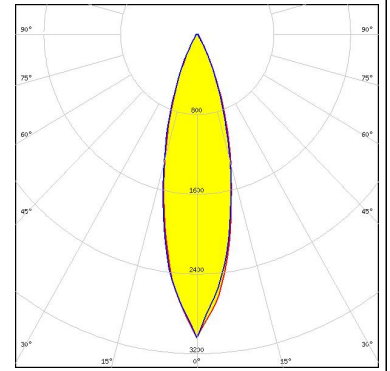

LUMILEDS

LED LUXEON CoB 1205HD
Ordering code CP19124_AMY-50-M-C2
FWHM / FWTM 26.0° / 50.0°
Efficiency 91 %
Peak intensity 3.4 cd/lm
LEDs/each optic 1
Light colour White
Required components:
F15858_HEKLA-SOCKET-H

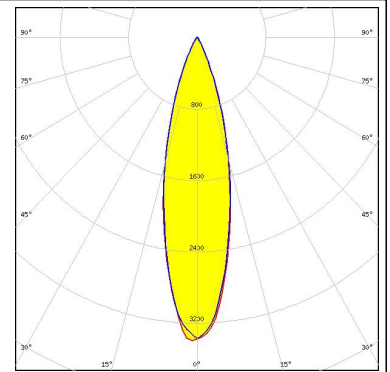

LUMILEDS

LED LUXEON CoB 1208
Ordering code CP19124_AMY-50-M-C2
FWHM / FWTM 31.0° / 58.0°
Efficiency 89 %
Peak intensity 2.5 cd/lm
LEDs/each optic 1
Light colour White
Required components:
Bender Wirth: 632a Hekla XL

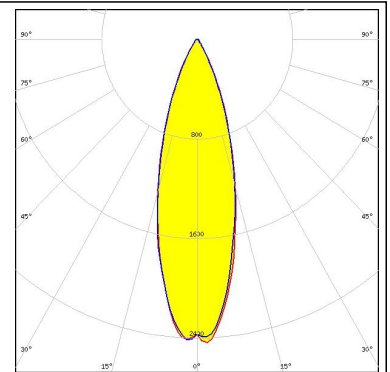

OPTICAL RESULTS (SIMULATED):

LUMILEDS

LED LUXEON CX Plus CoB - HD S01H4
 Ordering code CP19133_AMY-50-M-B2
 FWHM / FWTM 25.0° / 40.0°
 Efficiency 93 %
 Peak intensity 4.7 cd/lm
 LEDs/each optic 1
 Light colour White
 Required components:
 Bender Wirth: 634c Bayonet35L

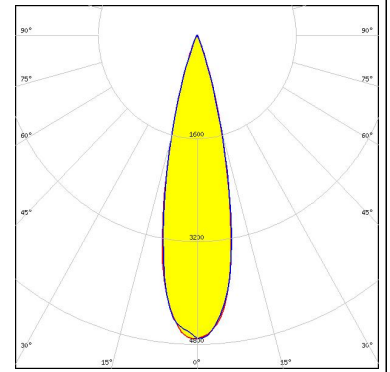

LUMILEDS

LED LUXEON CX Plus CoB - HD S02H6
 Ordering code CP19133_AMY-50-M-B2
 FWHM / FWTM 25.0° / 43.0°
 Efficiency 93 %
 Peak intensity 4.6 cd/lm
 LEDs/each optic 1
 Light colour White
 Required components:
 Bender Wirth: 634c Bayonet35L

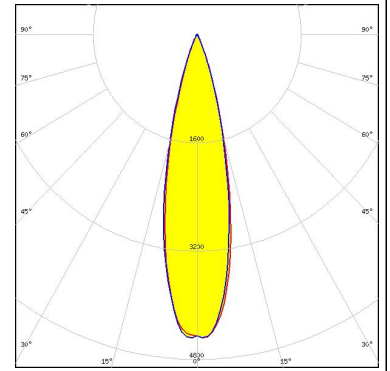

LUMILEDS

LED LUXEON CX Plus CoB - HD S04H9
 Ordering code CP19133_AMY-50-M-B2
 FWHM / FWTM 26.0° / 47.0°
 Efficiency 92 %
 Peak intensity 3.9 cd/lm
 LEDs/each optic 1
 Light colour White
 Required components:
 Bender Wirth: 634a Bayonet35L

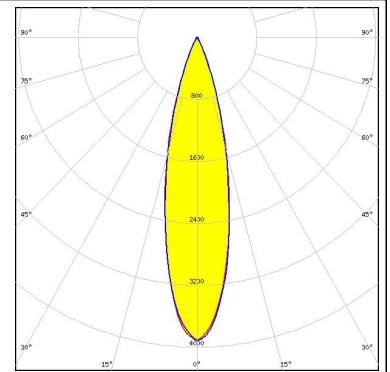

LUMILEDS

LED LUXEON CX Plus CoB L04 / L05 (Gen2)
 Ordering code CP19124_AMY-50-M-C2
 FWHM / FWTM 27.0° / 52.0°
 Efficiency 90 %
 Peak intensity 3.1 cd/lm
 LEDs/each optic 1
 Light colour White
 Required components:
 F15254_HEKLA-SOCKET-B

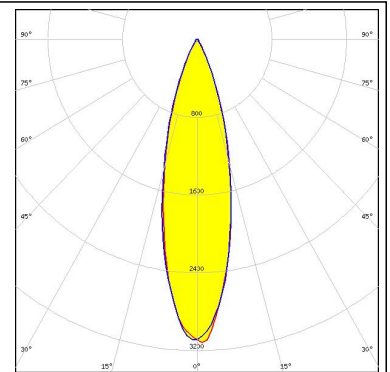

OPTICAL RESULTS (SIMULATED):

LUMILEDS

LED LUXEON CX Plus CoB M02 / M03 (Gen2)
 Ordering code CP19124_AMY-50-M-C2
 FWHM / FWTM 25.0° / 46.0°
 Efficiency 91 %
 Peak intensity 4 cd/lm
 LEDs/each optic 1
 Light colour White
 Required components:
 F15256_HEKLA-SOCKET-D

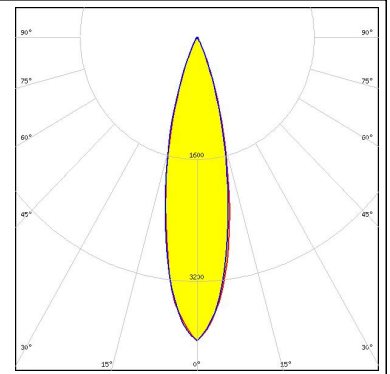

LUMILEDS

LED LUXEON CX Plus CoB S01 (Gen2)
 Ordering code CP19124_AMY-50-M-C2
 FWHM / FWTM 25.0° / 42.0°
 Efficiency 93 %
 Peak intensity 4.5 cd/lm
 LEDs/each optic 1
 Light colour White
 Required components:
 F15956_HEKLA-SOCKET-J

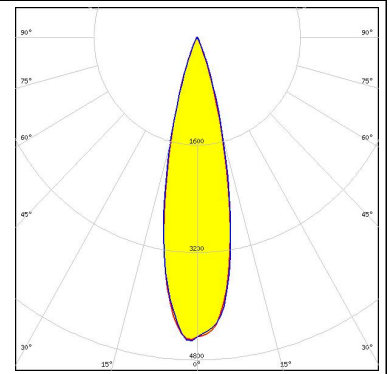

LUMINUS

LED CHM-9 XH (19x19)
 Ordering code CP19124_AMY-50-M-C2
 FWHM / FWTM 24.0° / 44.0°
 Efficiency 92 %
 Peak intensity 4.4 cd/lm
 LEDs/each optic 1
 Light colour White
 Required components:
 F15859_HEKLA-SOCKET-I

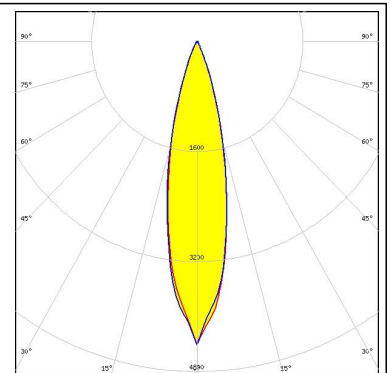

LUMINUS

LED CTM-6 (Tunable White) Gen2
 Ordering code CP19124_AMY-50-M-C2
 FWHM / FWTM 24.0° / 42.0°
 Efficiency 92 %
 Peak intensity 4.5 cd/lm
 LEDs/each optic 1
 Light colour Tunable White
 Required components:
 C16142_HEKLA-SOCKET-K
 Bender Wirth: 495 Typ L8

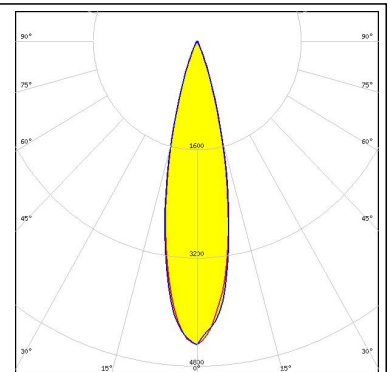

OPTICAL RESULTS (SIMULATED):



LED CTM-9 (Tunable White) Gen2
Ordering code CP19124_AMY-50-M-C2
FWHM / FWTM 26.0° / 46.0°
Efficiency 91 %
Peak intensity 3.9 cd/lm
LEDs/each optic 1
Light colour Tunable White
Required components:
 C16142_HEKLA-SOCKET-K
 Bender Wirth: 495 Typ L8

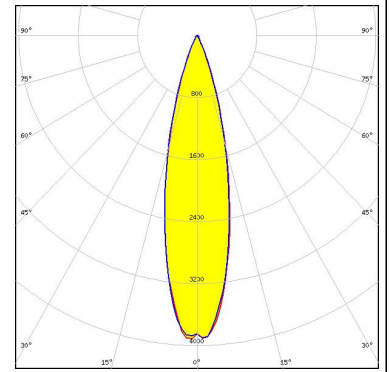

LED CxM-6 (13.5x13.5)
Ordering code CP19163_AMY-35-W-B2
FWHM / FWTM 24.0° / 42.0°
Efficiency 92 %
Peak intensity 4.7 cd/lm
LEDs/each optic 1
Light colour White
Required components:
 BJB: 47.360.1020

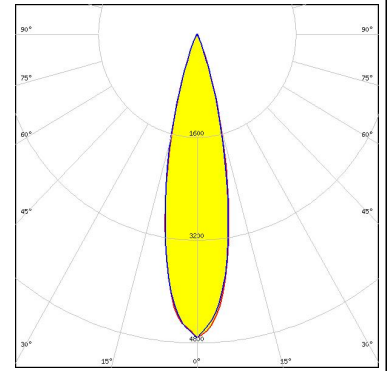

LED COB J-Type
Ordering code CP19124_AMY-50-M-C2
FWHM / FWTM 31.0° / 59.0°
Efficiency 89 %
Peak intensity 2.5 cd/lm
LEDs/each optic 1
Light colour White
Required components:
 Bender Wirth: 663a Hekla XL

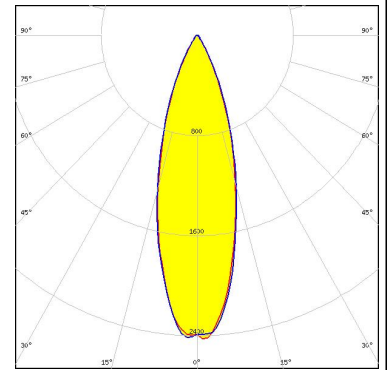

LED COB L-Type (LES 9)
Ordering code CP19124_AMY-50-M-C2
FWHM / FWTM 24.0° / 46.0°
Efficiency 92 %
Peak intensity 4.1 cd/lm
LEDs/each optic 1
Light colour White
Required components:
 F15858_HEKLA-SOCKET-H

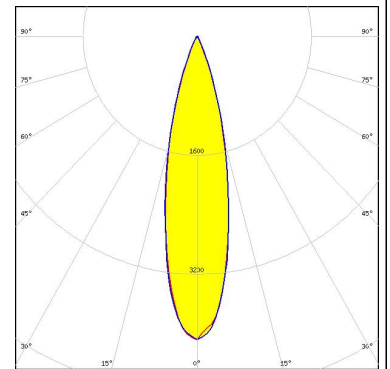

OPTICAL RESULTS (SIMULATED):



LED COB S-Type (LES 6)
Ordering code CP19133_AMY-50-M-B2
FWHM / FWTM 24.0° / 42.0°
Efficiency 93 %
Peak intensity 4.6 cd/lm
LEDs/each optic 1
Light colour White
Required components:
 Bender Wirth: 652a Bayonet35L

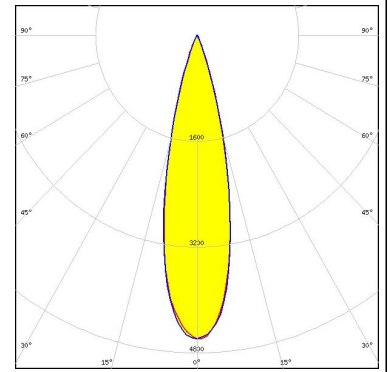

LED COB S-Type (LES 7)
Ordering code CP19133_AMY-50-M-B2
FWHM / FWTM 24.0° / 42.0°
Efficiency 93 %
Peak intensity 4.6 cd/lm
LEDs/each optic 1
Light colour White
Required components:
 Bender Wirth: 652a Bayonet35L

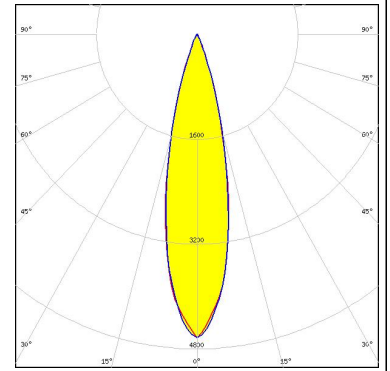

LED COB S-Type (LES 7)
Ordering code CP19124_AMY-50-M-C2
FWHM / FWTM 25.0° / 44.0°
Efficiency 89 %
Peak intensity 4.2 cd/lm
LEDs/each optic 1
Light colour White
Required components:
 Bender Wirth: 652a Hekla

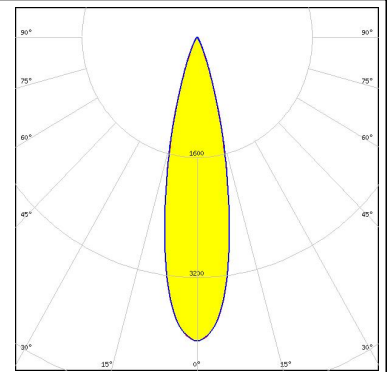

LED COB T-Type
Ordering code CP19133_AMY-50-M-B2
FWHM / FWTM 24.0° / 42.0°
Efficiency 93 %
Peak intensity 4.7 cd/lm
LEDs/each optic 1
Light colour White
Required components:
 Bender Wirth: 652a Bayonet35L

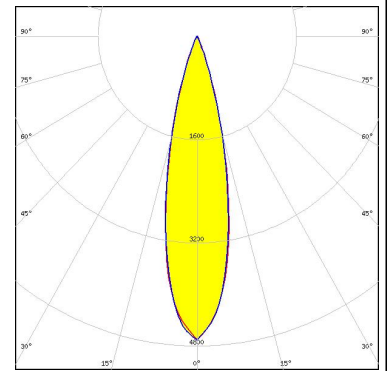

OPTICAL RESULTS (SIMULATED):



LED NJCWL024Z-V1MT: COB L-Type Tunable White
Ordering code CP19124_AMY-50-M-C2
FWHM / FWTM 24.0° / 42.0°
Efficiency 92 %
Peak intensity 4.6 cd/lm
LEDs/each optic 1
Light colour Tunable White
Required components:
 C16142_HEKLA-SOCKET-K
 Bender Wirth: 497 Typ L8 HV

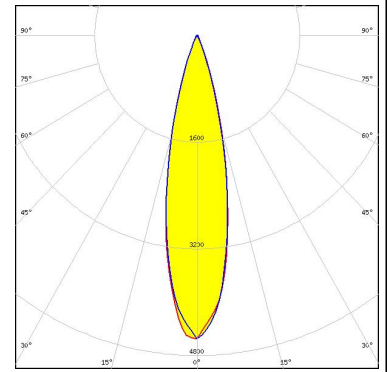

LED NJNWS012Z-V1MT: COB S-Type Tunable White
Ordering code CP19124_AMY-50-M-C2
FWHM / FWTM 24.0° / 40.0°
Efficiency 93 %
Peak intensity 4.7 cd/lm
LEDs/each optic 1
Light colour Tunable White
Required components:
 C16142_HEKLA-SOCKET-K
 Bender Wirth: 495 Typ L8 HV

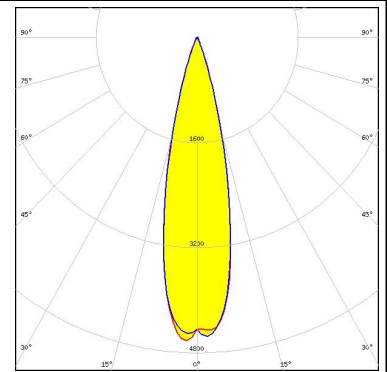

LED NVCWJ024Z-V1MT: COB J-Type Tunable White
Ordering code CP19124_AMY-50-M-C2
FWHM / FWTM 26.0° / 48.0°
Efficiency 90 %
Peak intensity 3.6 cd/lm
LEDs/each optic 1
Light colour Tunable White
Required components:
 C16142_HEKLA-SOCKET-K
 Bender Wirth: 498 Typ L8 HV

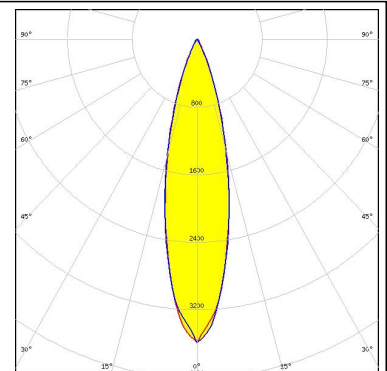

LED LC003D / LC006D / LC009D / LC013D
Ordering code CP19124_AMY-50-M-C2
FWHM / FWTM 25.1° / 48.3°
Efficiency 87 %
Peak intensity 3.6 cd/lm
LEDs/each optic 1
Light colour White
Required components:
 F15255_HEKLA-SOCKET-C

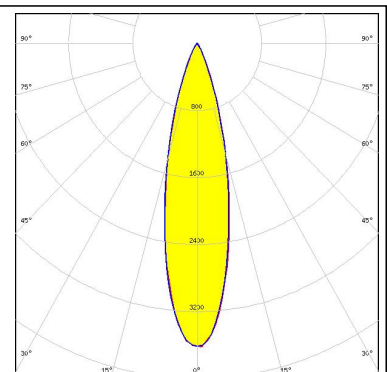

OPTICAL RESULTS (SIMULATED):

SAMSUNG

LED LC003D / LC006D / LC009D / LC013D
Ordering code CP19133_AMY-50-M-B2
FWHM / FWTM 24.0° / 46.0°
Efficiency 91 %
Peak intensity 4.1 cd/lm
LEDs/each optic 1
Light colour White
Required components:
BJB: 47.360.1020

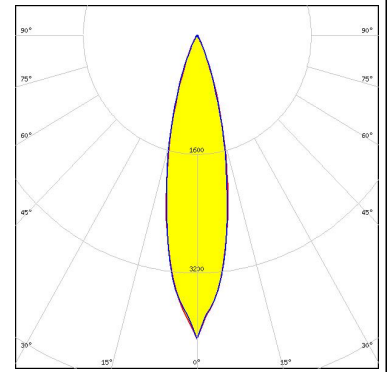

SAMSUNG

LED LC010C G2
Ordering code CP19133_AMY-50-M-B2
FWHM / FWTM 24.0° / 42.0°
Efficiency 92 %
Peak intensity 4.8 cd/lm
LEDs/each optic 1
Light colour White
Required components:
BJB: 47.360.1020

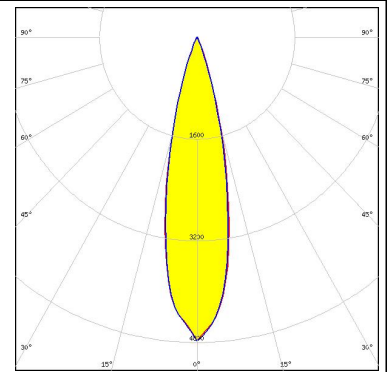

SAMSUNG

LED LC010T (Tunable White)
Ordering code CP19124_AMY-50-M-C2
FWHM / FWTM 25.0° / 44.0°
Efficiency 92 %
Peak intensity 4.2 cd/lm
LEDs/each optic 1
Light colour Tunable White
Required components:
Bender Wirth: 501 Typ L8

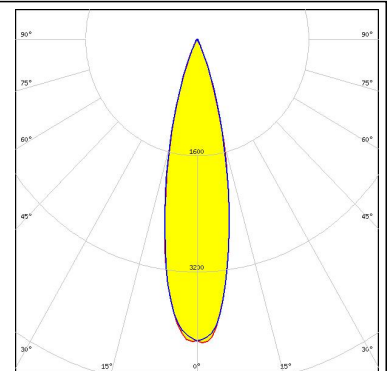

SAMSUNG

LED LC020C G2
Ordering code CP19133_AMY-50-M-B2
FWHM / FWTM 25.0° / 46.0°
Efficiency 90 %
Peak intensity 4 cd/lm
LEDs/each optic 1
Light colour White
Required components:
BJB: 47.360.1010

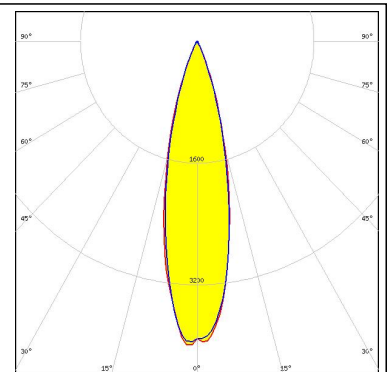

OPTICAL RESULTS (SIMULATED):

SAMSUNG

LED LC030C/040C G2
Ordering code CP19133_AMY-50-M-B2
FWHM / FWTM 28.0° / 52.0°
Efficiency 89 %
Peak intensity 3.2 cd/lm
LEDs/each optic 1
Light colour White
Required components:
BJB: 47.360.1010

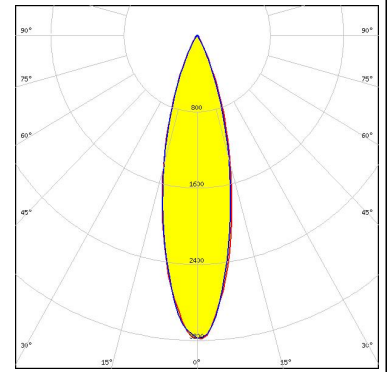

LED MJT COB LES 14.5
Ordering code CP19124_AMY-50-M-C2
FWHM / FWTM 30.0° / 59.0°
Efficiency 88 %
Peak intensity 2.4 cd/lm
LEDs/each optic 1
Light colour White
Required components:
F15859_HEKLA-SOCKET-I

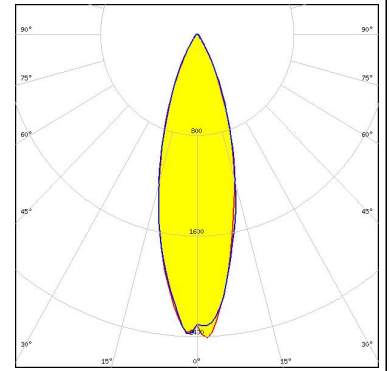

TRIDONIC

LED SLE SNC8 LES06
Ordering code CP19124_AMY-50-M-C2
FWHM / FWTM 24.0° / 42.0°
Efficiency 93 %
Peak intensity 4.7 cd/lm
LEDs/each optic 1
Light colour White
Required components:
F17435_HEKLA-G2-C

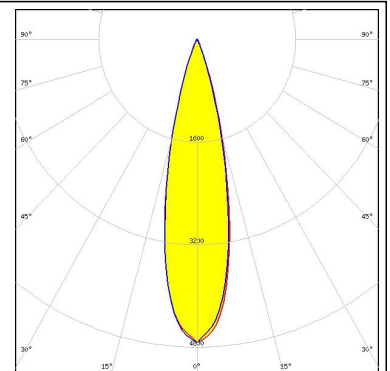

GENERAL INFORMATION:

NOTE: The typical beam angle will be changed by different color, chip size and chip position tolerance. The typical total beam angle is the full angle measured where the luminous intensity is half of the peak value.

Due to use of high power COB's with this product, special attention to proper thermal design is highly recommended. LEDiL has no liability for direct, indirect or consecutive damages arising from the LEDiL products being used outside of the recommended temperature range.

MATERIALS:

As part of our continuous research and improvement processes, and to ensure the best possible quality and availability of our products, LEDiL reserves the right to change material grades without notice.

PRODUCT DATA USER AGREEMENT AND DISCLAIMER:

The measured data in the provided downloadable LEDiL Product Datasheets and Mechanical 2D-Drawings is rounded and provided as reference for planning. LEDiL Oy's optical specifications have been verified by conducting performance testing of the products in accordance with the company's quality system. The reported data are averaged results of multiple measurements with typical variation. LEDiL Oy reserves the right to without prior notification make changes and improvements to its products.

LEDiL Oy assumes neither warranty, nor guarantee nor any other liability of any kind for the contents and correctness of the provided data. The provided data has been generated with highest diligence but the provided data may in reality not represent the complete possible variation range of all intrinsic parameters. Therefore, in certain cases a deviation from the provided data could occur.

LEDiL Oy reserves the right to undertake technical changes of its products without further notification which could lead to changes in the provided data. LEDiL Oy assumes no liability of any kind for the possible deviation from any provided data or any other damage resulting from the usage of the provided data.

The user agrees to this disclaimer and user agreement with the download or usage of the provided files.

LEDiL Oy

Joensuunkatu 13
FI-24240 SALO
Finland

LEDiL Inc.

228 West Page Street
Suite D
Sycamore IL 60178
USA

Ledil Optics Technology (Shenzhen) Co., Ltd.

405 , Block B
Casic Motor Building
Shenzhen 518057
P.R.CHINA

Local sales and technical support

[www.ledil.com/
where_to_buy](http://www.ledil.com/where_to_buy)

Shipping locations

Salo, Finland
Hong Kong, China

Distribution Partners

[www.ledil.com/
where_to_buy](http://www.ledil.com/where_to_buy)