

AMY-50-W

~36° wide beam

SPECIFICATION:

Dimensions	Ø 49.9 mm
Height	11 mm
Fastening	socket
ROHS compliant	yes ⓘ

MATERIALS:

Component	Type	Material	Colour	Finish
AMY-50-W	Single lens	PMMA	clear	
AMY-50-HLD2-C	Holder C	PC	black	
AMY-50-HLD2-B	Holder B	PC	black	
AMY-50-HLD2-C-WHT	Holder C	PC	white	
AMY-50-HLD2-B-WHT	Holder B	PC	white	



ORDERING INFORMATION:

Component	Qty in box	MOQ	MPQ	Box weight (kg)
C17688_AMY-50-W	690	120	30	9.3
Assembly				
CP19152_AMY-50-W-B2-WHT	510	120	30	8.6
CP19143_AMY-50-W-C2-WHT	510	120	30	8.2
CP19134_AMY-50-W-B2	510	120	30	8.6
CP19125_AMY-50-W-C2	510	120	30	8.2

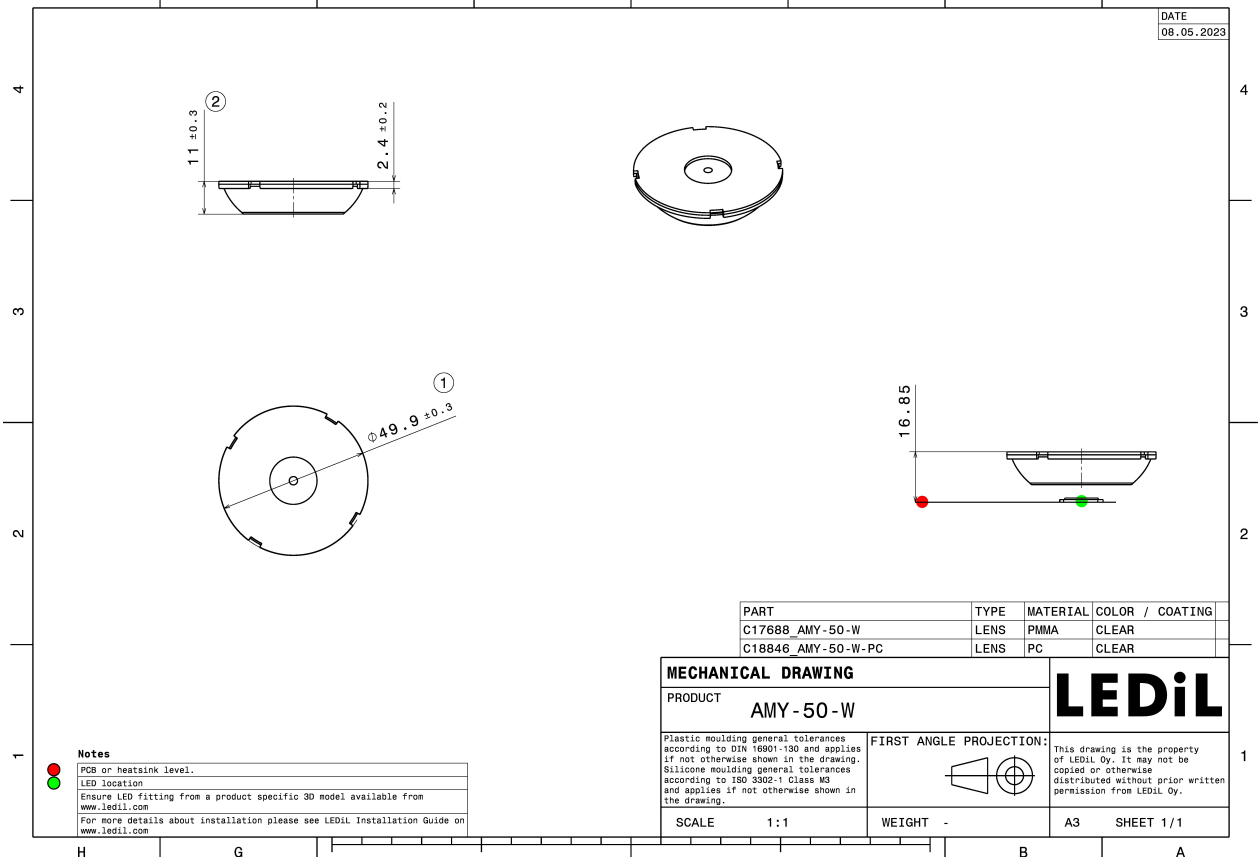
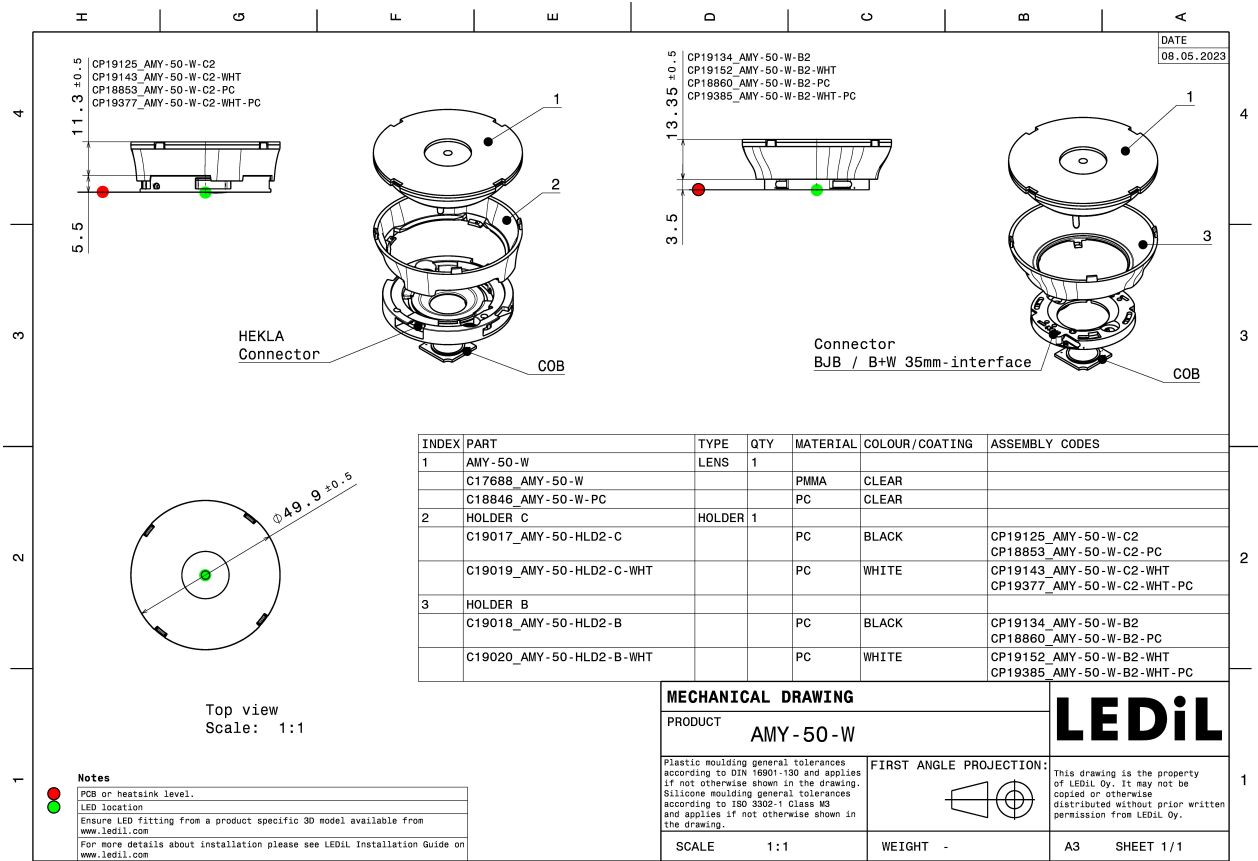

See also our general installation guide: www.ledil.com/installation_guide

OPTICAL RESULTS (MEASURED):



OPTICAL RESULTS (MEASURED):

			
LED	V6 HD Gen 7		
Ordering code	CP19125_AMY-50-W-C2		
FWHM / FWTM	36.0° / 58.0°		
Efficiency	88 %		
LEDs/each optic	1		
Light colour	White		
Required components:			
F15255_HEKLA-SOCKET-C			

			
LED	V8 Gen 8-9		
Ordering code	CP19125_AMY-50-W-C2		
FWHM / FWTM	36.0° / 60.0°		
Efficiency	89 %		
LEDs/each optic	1		
Light colour	White		
Required components:			
F15253_HEKLA-SOCKET-A			

			
LED	V9 HD Gen7		
Ordering code	CP19125_AMY-50-W-C2		
FWHM / FWTM	34.0° / 59.0°		
Efficiency	86 %		
LEDs/each optic	1		
Light colour	White		
Required components:			
F15859_HEKLA-SOCKET-I			

			
LED	VERO10		
Ordering code	CP19125_AMY-50-W-C2		
FWHM / FWTM	34.0° / 60.0°		
Efficiency	87 %		
LEDs/each optic	1		
Light colour	White		
Required components:			
F15616_HEKLA-SOCKET-F			

OPTICAL RESULTS (MEASURED):

bridgelux.

LED Vesta DTW 13mm (21W)
 Ordering code CP19125_AMY-50-W-C2
 FWHM / FWTM 35.0° / 65.0°
 Efficiency 82 %
 LEDs/each optic 1
 Light colour White

Required components:
 C16142_HEKLA-SOCKET-K
 Bender Wirth: 491 Typ L8



bridgelux.

LED Vesta DTW 15mm (33W)
 Ordering code CP19125_AMY-50-W-C2
 FWHM / FWTM 37.0° / 67.0°
 Efficiency 83 %
 LEDs/each optic 1
 Light colour White

Required components:
 C16142_HEKLA-SOCKET-K
 Bender Wirth: 491 Typ L8



bridgelux.

LED Vesta TW 13mm (18W) DP
 Ordering code CP19125_AMY-50-W-C2
 FWHM / FWTM 36.0° / 66.0°
 Efficiency 83 %
 LEDs/each optic 1
 Light colour White

Required components:
 C16142_HEKLA-SOCKET-K
 Bender Wirth: 492 Typ L8



bridgelux.

LED Vesta TW 15mm DP
 Ordering code CP19125_AMY-50-W-C2
 FWHM / FWTM 38.0° / 68.0°
 Efficiency 79 %
 LEDs/each optic 1
 Light colour White

Required components:
 C16142_HEKLA-SOCKET-K
 Bender Wirth: 482 Typ L8



OPTICAL RESULTS (MEASURED):

			
LED	Vesta TW 6mm DP		
Ordering code	CP19125_AMY-50-W-C2		
FWHM / FWTM	36.0° / 57.0°		
Efficiency	86 %		
LEDs/each optic	1		
Light colour	White		
Required components:			
C16142_HEKLA-SOCKET-K			
Bender Wirth: 504 Typ L8			

			
LED	Vesta TW 6mm DP		
Ordering code	CP19134_AMY-50-W-B2		
FWHM / FWTM	37.0° / 58.0°		
Efficiency	86 %		
LEDs/each optic	1		
Light colour	White		
Required components:			
Bender Wirth: 504 Typ B35L			

			
LED	Vesta TW 9mm (9W) DP		
Ordering code	CP19125_AMY-50-W-C2		
FWHM / FWTM	35.0° / 60.0°		
Efficiency	85 %		
LEDs/each optic	1		
Light colour	White		
Required components:			
C16142_HEKLA-SOCKET-K			
Bender Wirth: 489 Typ L8			

<h2>CITIZEN</h2>			
LED	CLL02x/CLU02x (LES10)		
Ordering code	CP19143_AMY-50-W-C2-WHT		
FWHM / FWTM	35.0° / 59.0°		
Efficiency	94 %		
Peak intensity	2.1 cd/lm		
LEDs/each optic	1		
Light colour	White		
Required components:			
F17435_HEKLA-G2-C			

OPTICAL RESULTS (MEASURED):

CITIZEN

LED CLL02x/CLU02x (LES10)
Ordering code CP19134_AMY-50-W-B2
FWHM / FWTM 35.0° / 60.0°
Efficiency 87 %
LEDs/each optic 1
Light colour White
Required components:
Green Gems: GH27d

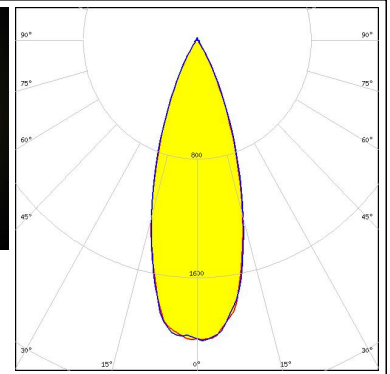
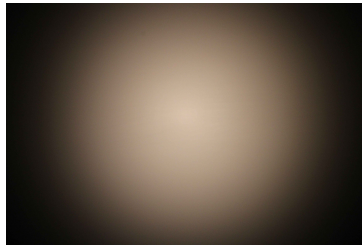

CITIZEN

LED CLL02x/CLU02x (LES10)
Ordering code CP19125_AMY-50-W-C2
FWHM / FWTM 34.0° / 60.0°
Efficiency 86 %
LEDs/each optic 1
Light colour White
Required components:
F17435_HEKLA-G2-C

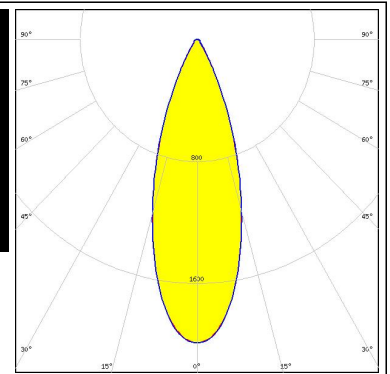
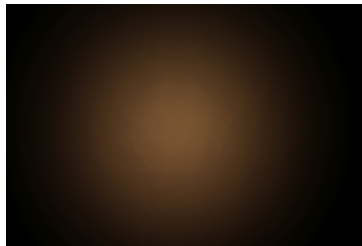

CITIZEN

LED CLL03x/CLU03x
Ordering code CP19125_AMY-50-W-C2
FWHM / FWTM 36.0° / 67.0°
Efficiency 84 %
LEDs/each optic 1
Light colour White
Required components:
F17438_HEKLA-G2-I

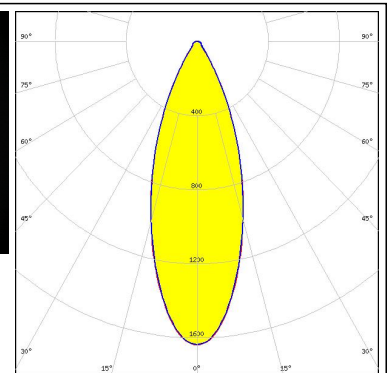
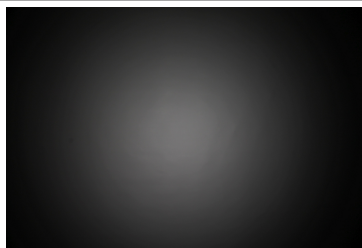

CITIZEN

LED CLU700/701/702/703
Ordering code CP19125_AMY-50-W-C2
FWHM / FWTM 35.0° / 57.0°
Efficiency 87 %
LEDs/each optic 1
Light colour White
Required components:
F17435_HEKLA-G2-C

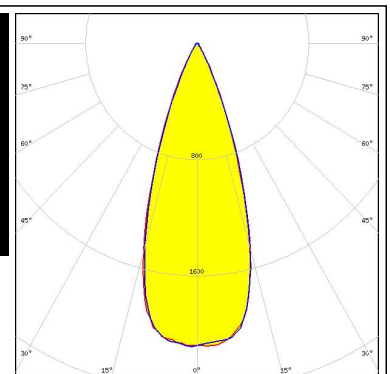
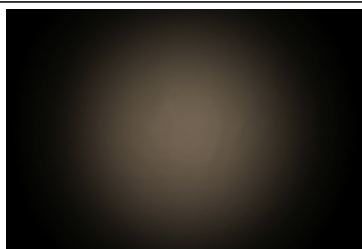

OPTICAL RESULTS (MEASURED):

CITIZEN

LED CLU7A2/7A3
Ordering code CP19125_AMY-50-W-C2
FWHM / FWTM 36.0° / 56.0°
Efficiency 87 %
LEDs/each optic 1
Light colour White
Required components:
F17435_HEKLA-G2-C

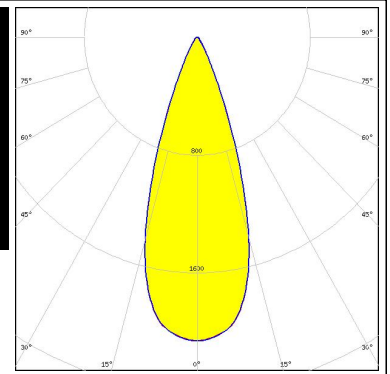
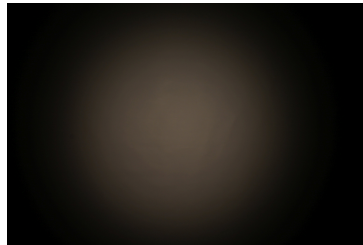

CITIZEN

LED CLU7B2
Ordering code CP19125_AMY-50-W-C2
FWHM / FWTM 36.0° / 55.0°
Efficiency 88 %
LEDs/each optic 1
Light colour White
Required components:
F17435_HEKLA-G2-C

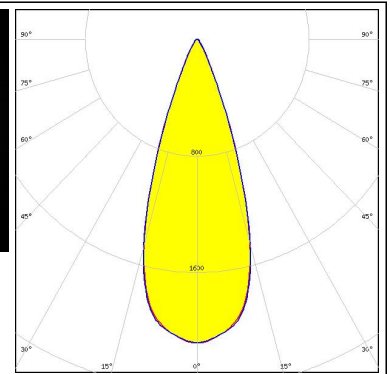
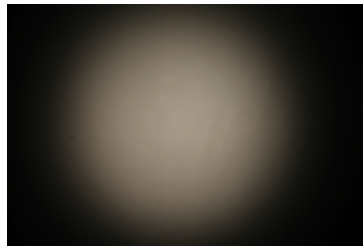

CITIZEN

LED CLU7L3
Ordering code CP19134_AMY-50-W-B2
FWHM / FWTM 38.0° / 54.0°
Efficiency 89 %
LEDs/each optic 1
Light colour White
Required components:
Bender Wirth: 667a Bayonet35

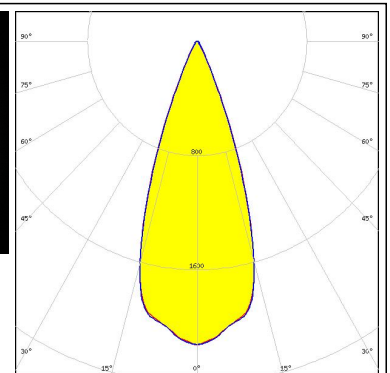
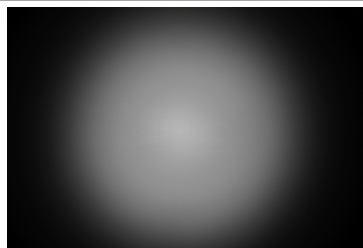

CITIZEN

LED CLU7S3
Ordering code CP19134_AMY-50-W-B2
FWHM / FWTM 38.0° / 55.0°
Efficiency 88 %
LEDs/each optic 1
Light colour White
Required components:
Bender Wirth: 667a Bayonet35

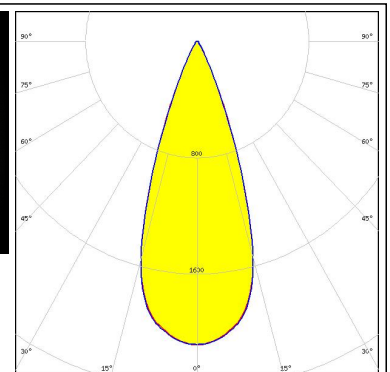
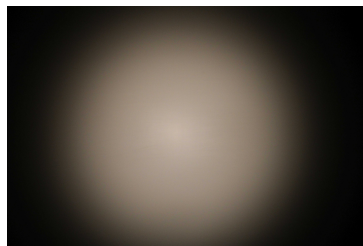

OPTICAL RESULTS (MEASURED):



LED CMA1516
Ordering code CP19125_AMY-50-W-C2
FWHM / FWTM 35.0° / 60.0°
Efficiency 87 %
LEDs/each optic 1
Light colour White
Required components:
 F17436_HEKLA-G2-D

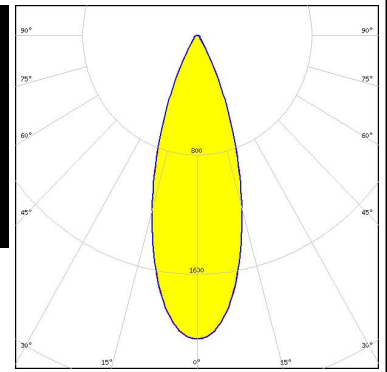
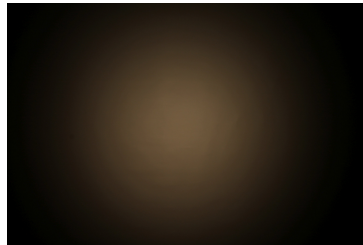

LED CMA1825
Ordering code CP19125_AMY-50-W-C2
FWHM / FWTM 35.0° / 64.0°
Efficiency 86 %
LEDs/each optic 1
Light colour White
Required components:
 F15254_HEKLA-SOCKET-B

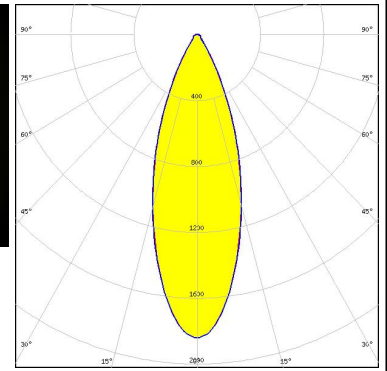
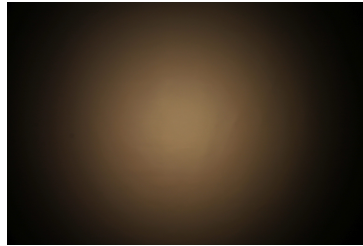

LED CMT14xx
Ordering code CP19125_AMY-50-W-C2
FWHM / FWTM 34.0° / 60.0°
Efficiency 86 %
LEDs/each optic 1
Light colour White
Required components:
 F17435_HEKLA-G2-C

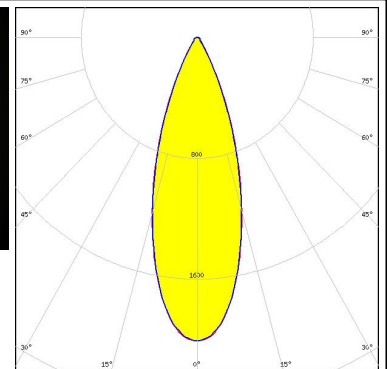
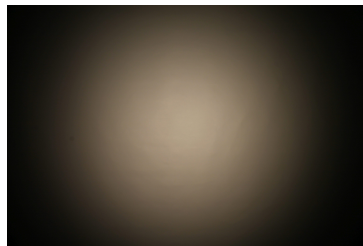

LED CMT19xx
Ordering code CP19125_AMY-50-W-C2
FWHM / FWTM 36.0° / 67.0°
Efficiency 84 %
LEDs/each optic 1
Light colour White
Required components:
 F17438_HEKLA-G2-I

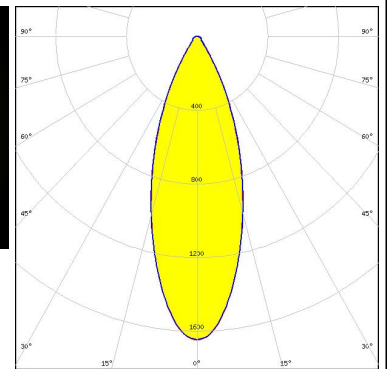
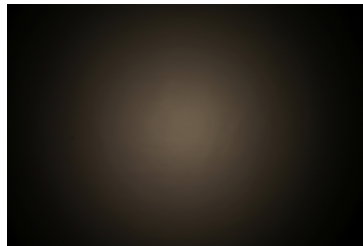

OPTICAL RESULTS (MEASURED):



LED CMU10xx
Ordering code CP19125_AMY-50-W-C2
FWHM / FWTM 35.0° / 61.0°
Efficiency 87 %
LEDs/each optic 1
Light colour White
Required components:
 F17435_HEKLA-G2-C

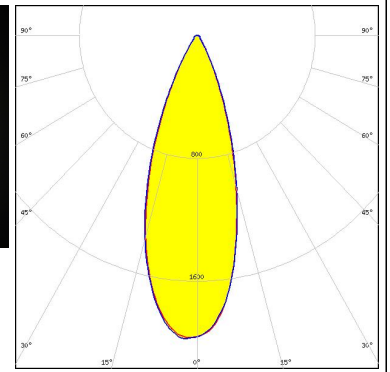
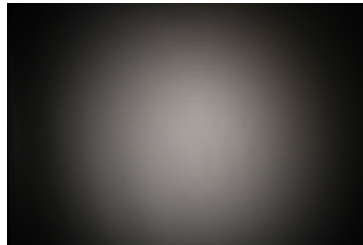

LED CXA/B 13xx
Ordering code CP19125_AMY-50-W-C2
FWHM / FWTM 36.0° / 57.0°
Efficiency 88 %
LEDs/each optic 1
Light colour White
Required components:
 F17439_HEKLA-G2-J

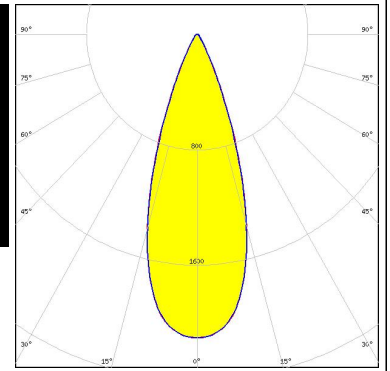
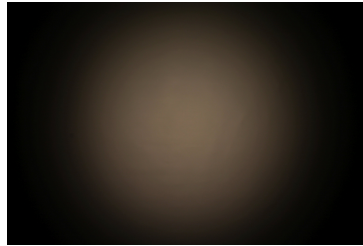

LED CXA/B 15xx
Ordering code CP19125_AMY-50-W-C2
FWHM / FWTM 35.0° / 59.0°
Efficiency 87 %
LEDs/each optic 1
Light colour White
Required components:
 F17436_HEKLA-G2-D

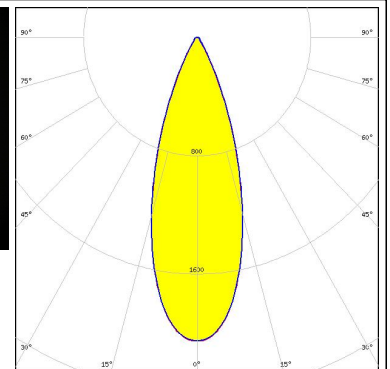
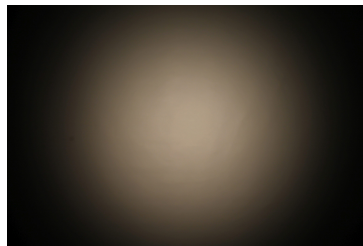

LED LEDIM/C6
Ordering code CP19125_AMY-50-W-C2
FWHM / FWTM 35.0° / 60.0°
Efficiency 87 %
LEDs/each optic 1
Light colour White
Required components:
 F17438_HEKLA-G2-I

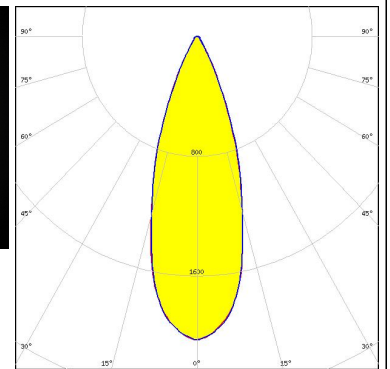
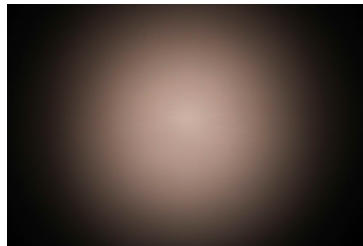

OPTICAL RESULTS (MEASURED):



LED LUXEON 7070
Ordering code CP19134_AMY-50-W-B2
FWHM / FWTM 37.0° / 58.0°
Efficiency 89 %
LEDs/each optic 1
Light colour White
Required components:
Bender Wirth: 634a Bayonet35L

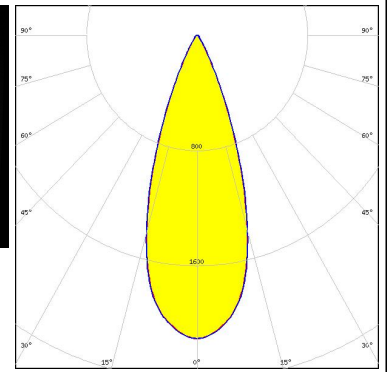
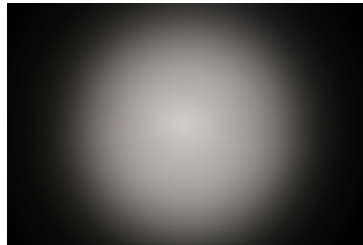

LED LUXEON CoB 1202/1203
Ordering code CP19125_AMY-50-W-C2
FWHM / FWTM 34.0° / 59.0°
Efficiency 86 %
LEDs/each optic 1
Light colour White
Required components:
F17437_HEKLA-G2-H

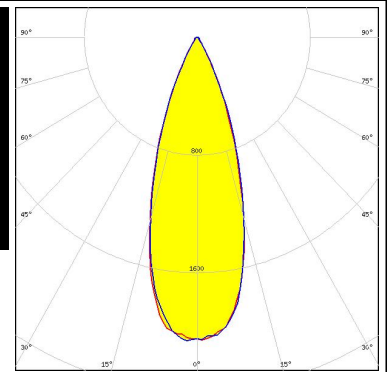
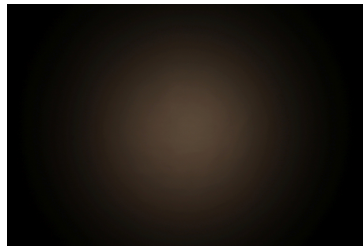

LED LUXEON CoB 1204HD
Ordering code CP19125_AMY-50-W-C2
FWHM / FWTM 35.0° / 60.0°
Efficiency 86 %
LEDs/each optic 1
Light colour White
Required components:
F17437_HEKLA-G2-H

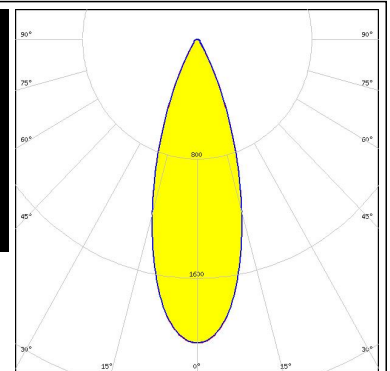
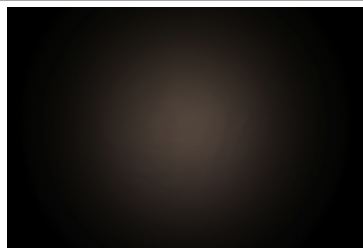

LED LUXEON CoB M02/M03
Ordering code CP19125_AMY-50-W-C2
FWHM / FWTM 35.0° / 60.0°
Efficiency 87 %
LEDs/each optic 1
Light colour White
Required components:
F17436_HEKLA-G2-D

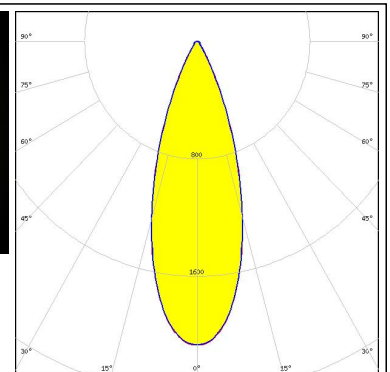
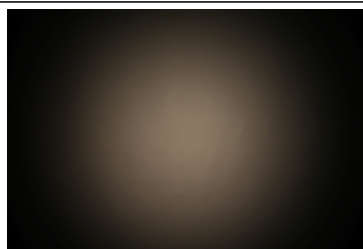

OPTICAL RESULTS (MEASURED):

			
LED	LUXEON CoB S01		
Ordering code	CP19125_AMY-50-W-C2		
FWHM / FWTM	36.0° / 57.0°		
Efficiency	88 %		
LEDs/each optic	1		
Light colour	White		
Required components:			
F17439_HEKLA-G2-J			

			
LED	LUXEON Fusion 12-up (20x24)		
Ordering code	CP19125_AMY-50-W-C2		
FWHM / FWTM	35.0° / 61.0°		
Efficiency	80 %		
LEDs/each optic	1		
Light colour	White		
Required components:			
C16142_HEKLA-SOCKET-K			
F18158_HEKLA-RZ-LENS			
Bender Wirth: 442 Typ L8			

			
LED	LUXEON Fusion 21-up (20x24)		
Ordering code	CP19125_AMY-50-W-C2		
FWHM / FWTM	35.0° / 62.0°		
Efficiency	79 %		
LEDs/each optic	1		
Light colour	White		
Required components:			
C16142_HEKLA-SOCKET-K			
F18158_HEKLA-RZ-LENS			
Bender Wirth: 442 Typ L8			

			
LED	LUXEON Fusion 27-up (20x24)		
Ordering code	CP19125_AMY-50-W-C2		
FWHM / FWTM	35.0° / 65.0°		
Efficiency	78 %		
LEDs/each optic	1		
Light colour	White		
Required components:			
C16142_HEKLA-SOCKET-K			
F18158_HEKLA-RZ-LENS			
Bender Wirth: 442 Typ L8			

OPTICAL RESULTS (MEASURED):

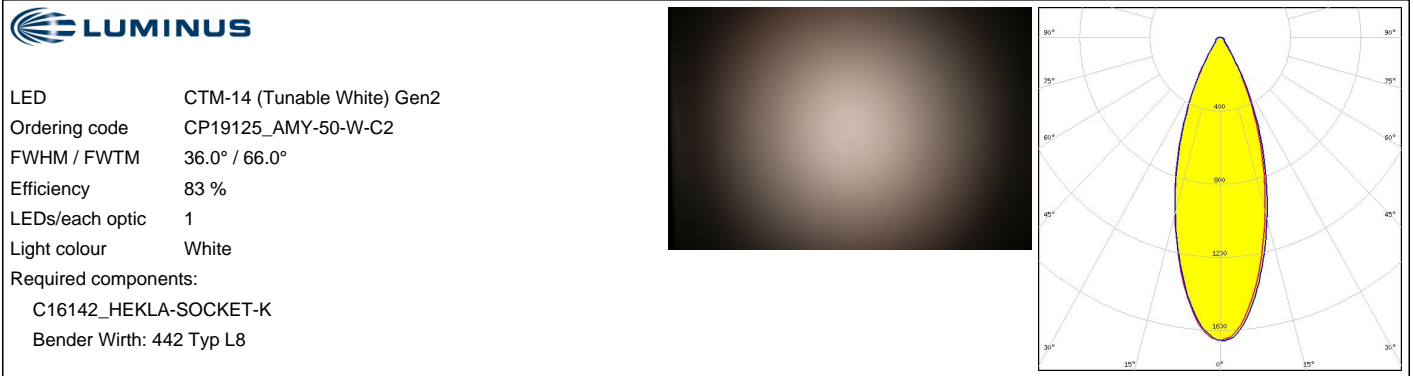

OPTICAL RESULTS (MEASURED):

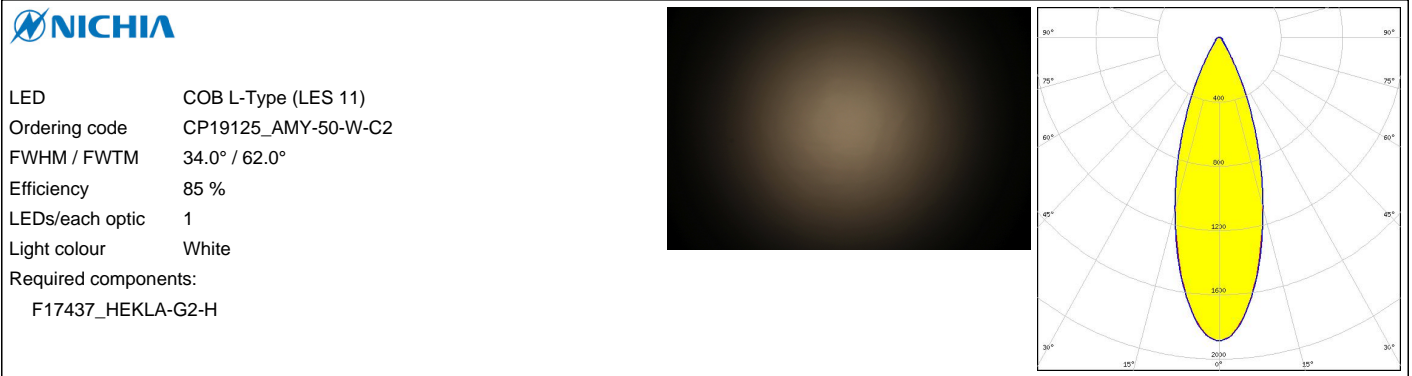

OPTICAL RESULTS (MEASURED):

SAMSUNG

LED LC003D / LC006D / LC009D / LC013D
 Ordering code CP19125_AMY-50-W-C2
 FWHM / FWTM 34.0° / 60.0°
 Efficiency 86 %
 LEDs/each optic 1
 Light colour White
 Required components:
 F17435_HEKLA-G2-C

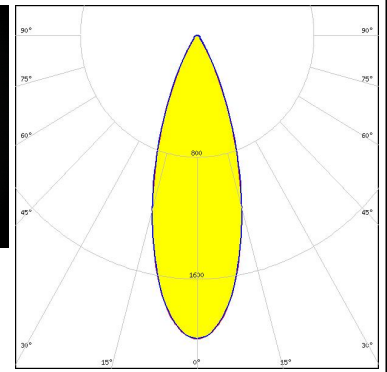
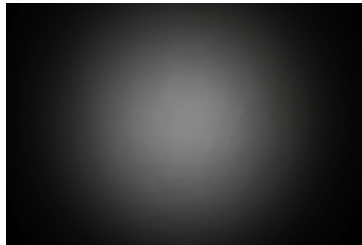

SAMSUNG

LED LC016D / LC019D / LC026D / LC033D
 Ordering code CP19125_AMY-50-W-C2
 FWHM / FWTM 38.0° / 70.0°
 Efficiency 84 %
 LEDs/each optic 1
 Light colour White
 Required components:
 F17438_HEKLA-G2-I

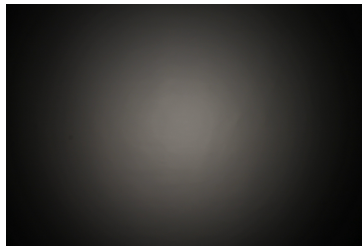

SAMSUNG

LED LC030C/040C G2
 Ordering code CP19125_AMY-50-W-C2
 FWHM / FWTM 35.0° / 63.0°
 Efficiency 85 %
 LEDs/each optic 1
 Light colour White
 Required components:
 F17438_HEKLA-G2-I

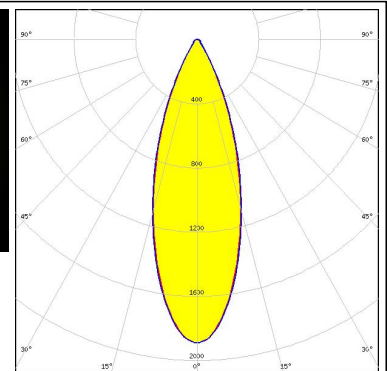
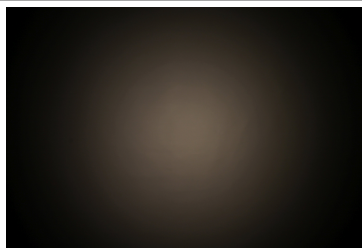

LED MJT COB LES 14.5
 Ordering code CP19125_AMY-50-W-C2
 FWHM / FWTM 37.0° / 68.0°
 Efficiency 84 %
 LEDs/each optic 1
 Light colour White
 Required components:
 F17438_HEKLA-G2-I

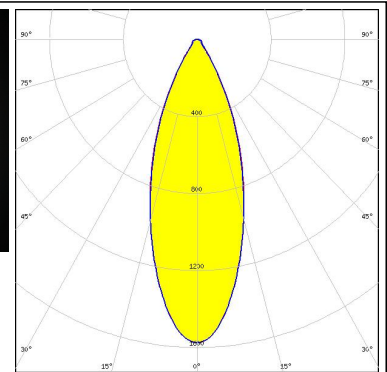
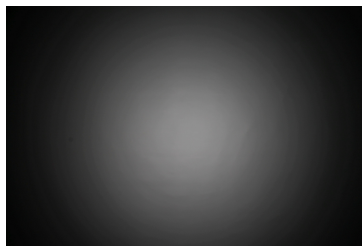

OPTICAL RESULTS (MEASURED):



OPTICAL RESULTS (MEASURED):

TRIDONIC

LED SLE G7 LES15
Ordering code CP19125_AMY-50-W-C2
FWHM / FWTM 37.0° / 68.0°
Efficiency 84 %
LEDs/each optic 1
Light colour White
Required components:
F17438_HEKLA-G2-I

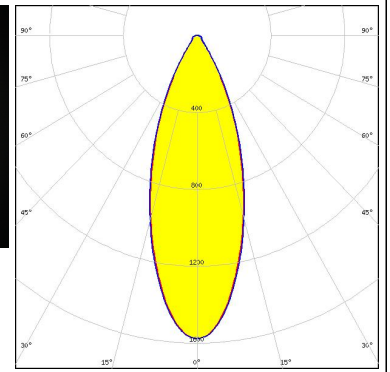
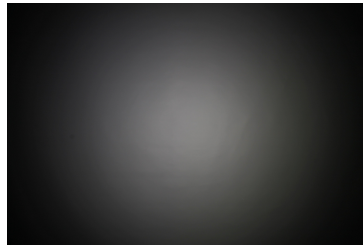

OPTICAL RESULTS (SIMULATED):



LED V10 Gen 8-9
Ordering code CP19134_AMY-50-W-B2
FWHM / FWTM 35.0° / 60.0°
Efficiency 86 %
Peak intensity 2.1 cd/lm
LEDs/each optic 1
Light colour White
Required components:
 BJB: 47.360.1020

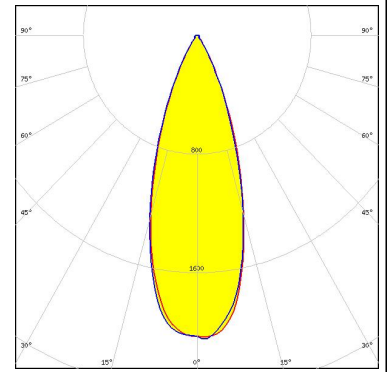

LED V3 HD Gen 8
Ordering code CP19125_AMY-50-W-C2
FWHM / FWTM 37.0° / 56.0°
Efficiency 91 %
Peak intensity 2.2 cd/lm
LEDs/each optic 1
Light colour White
Required components:
 F15253_HEKLA-SOCKET-A



LED V3 HD Gen 8 FC
Ordering code CP19125_AMY-50-W-C2
FWHM / FWTM 38.0° / 55.0°
Efficiency 91 %
Peak intensity 2.2 cd/lm
LEDs/each optic 1
Light colour White
Required components:
 F15255_HEKLA-SOCKET-C

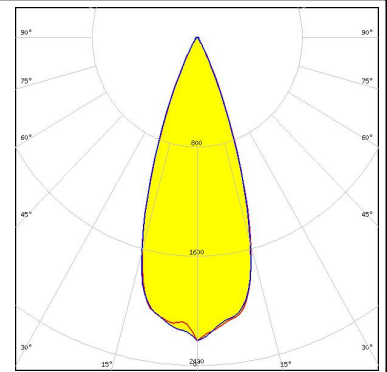

LED V4 HD Gen 8
Ordering code CP19125_AMY-50-W-C2
FWHM / FWTM 37.0° / 56.0°
Efficiency 91 %
Peak intensity 2.2 cd/lm
LEDs/each optic 1
Light colour White
Required components:
 F15253_HEKLA-SOCKET-A

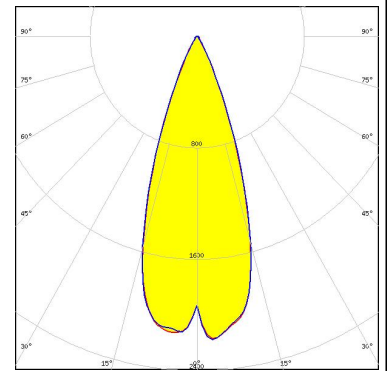

OPTICAL RESULTS (SIMULATED):

bridgelux

LED V6 Gen 8-9
 Ordering code CP19125_AMY-50-W-C2
 FWHM / FWTM 37.0° / 57.0°
 Efficiency 90 %
 Peak intensity 2.2 cd/lm
 LEDs/each optic 1
 Light colour White
 Required components:
 F15253_HEKLA-SOCKET-A

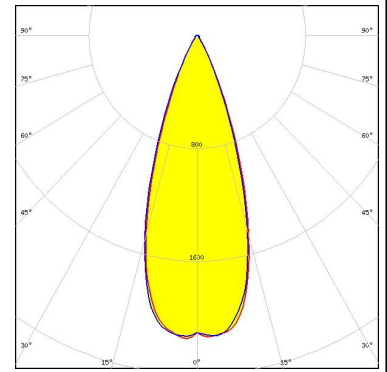

bridgelux

LED V6 HD Gen 8
 Ordering code CP19125_AMY-50-W-C2
 FWHM / FWTM 36.0° / 58.0°
 Efficiency 90 %
 Peak intensity 2.2 cd/lm
 LEDs/each optic 1
 Light colour White
 Required components:
 F15255_HEKLA-SOCKET-C

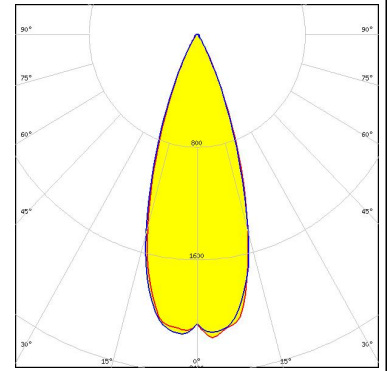

bridgelux

LED V8 Gen7
 Ordering code CP19125_AMY-50-W-C2
 FWHM / FWTM 36.0° / 58.0°
 Efficiency 86 %
 Peak intensity 2.2 cd/lm
 LEDs/each optic 1
 Light colour White
 Required components:
 F15253_HEKLA-SOCKET-A

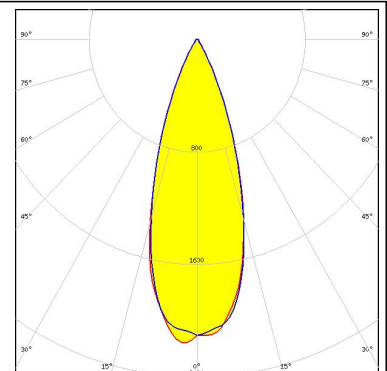

bridgelux

LED V9 HD Gen 8
 Ordering code CP19125_AMY-50-W-C2
 FWHM / FWTM 35.0° / 59.0°
 Efficiency 89 %
 Peak intensity 2.2 cd/lm
 LEDs/each optic 1
 Light colour White
 Required components:
 F15859_HEKLA-SOCKET-I

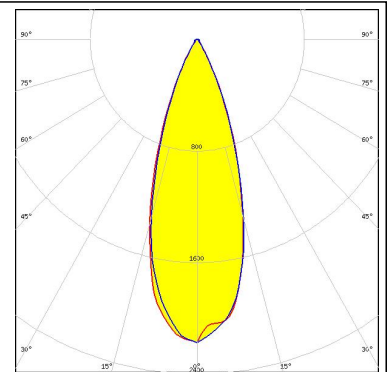

OPTICAL RESULTS (SIMULATED):

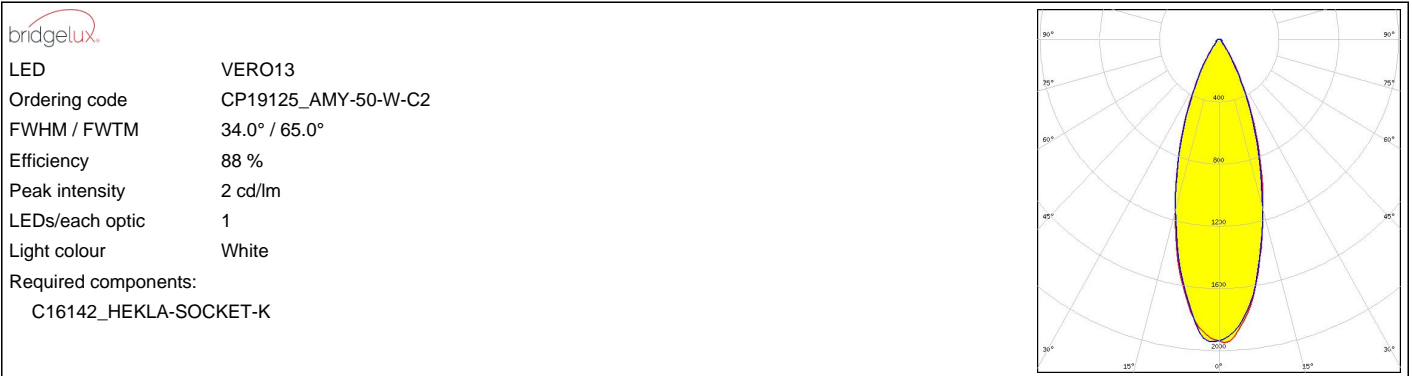

OPTICAL RESULTS (SIMULATED):



LED Vesta SE 13mm TW
Ordering code CP19125_AMY-50-W-C2
FWHM / FWTM 33.0° / 63.0°
Efficiency 81 %
Peak intensity 1.8 cd/lm
LEDs/each optic 1
Light colour Tunable White
Required components:
 C16142_HEKLA-SOCKET-K

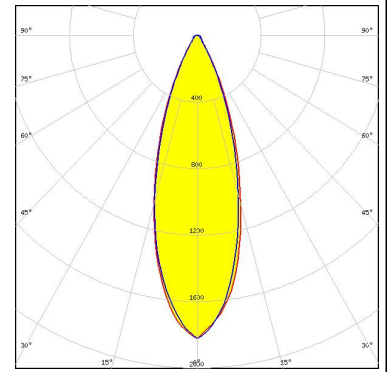

CITIZEN

LED CLL02x/CLU02x (LES10)
Ordering code CP19134_AMY-50-W-B2
FWHM / FWTM 35.0° / 60.0°
Efficiency 88 %
Peak intensity 2 cd/lm
LEDs/each optic 1
Light colour White
Required components:
 BJB: 47.360.1020

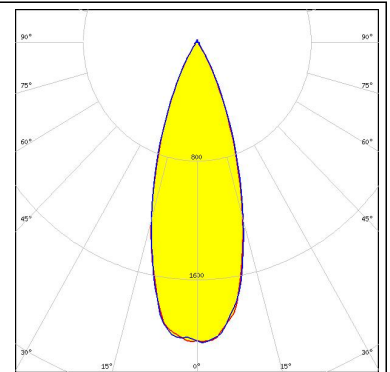

CITIZEN

LED CLL04x/CLU04x
Ordering code CP19125_AMY-50-W-C2
FWHM / FWTM 42.0° / 83.0°
Efficiency 73 %
Peak intensity 1 cd/lm
LEDs/each optic 1
Light colour White
Required components:
 Bender Wirth: 631a Hekla XL

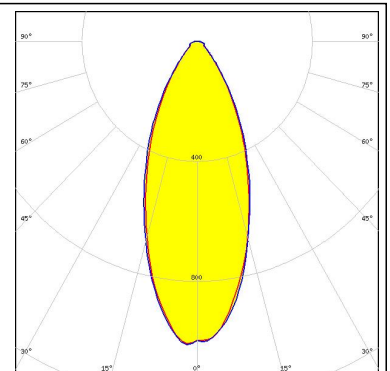

CITIZEN

LED CLU700/701/702/703
Ordering code CP19125_AMY-50-W-C2
FWHM / FWTM 36.2° / 56.3°
Efficiency 87 %
Peak intensity 2.1 cd/lm
LEDs/each optic 1
Light colour White
Required components:
 F15255_HEKLA-SOCKET-C

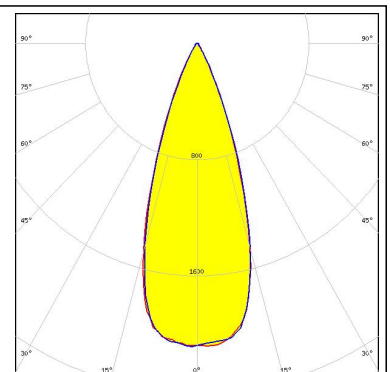

OPTICAL RESULTS (SIMULATED):

CITIZEN

LED CLU700/701/702/703
 Ordering code CP19134_AMY-50-W-B2
 FWHM / FWTM 36.2° / 56.3°
 Efficiency 90 %
 Peak intensity 2.1 cd/lm
 LEDs/each optic 1
 Light colour White
 Required components:
 BJB: 47.360.1020

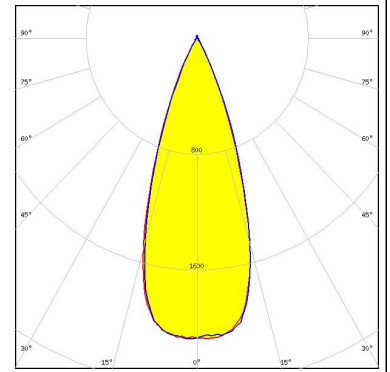

CITIZEN

LED CLU710/711
 Ordering code CP19134_AMY-50-W-B2
 FWHM / FWTM 36.0° / 58.0°
 Efficiency 89 %
 Peak intensity 2.1 cd/lm
 LEDs/each optic 1
 Light colour White
 Required components:
 BJB: 47.360.1010

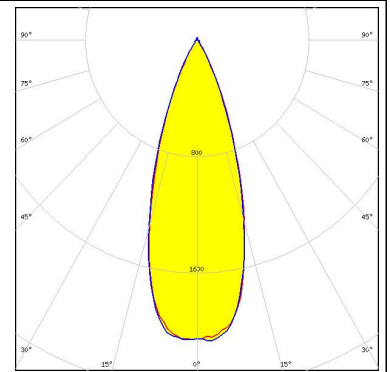

CITIZEN

LED CLU712/713
 Ordering code CP19125_AMY-50-W-C2
 FWHM / FWTM 36.0° / 60.0°
 Efficiency 87 %
 Peak intensity 2.1 cd/lm
 LEDs/each optic 1
 Light colour White
 Required components:
 F17438_HEKLA-G2-I

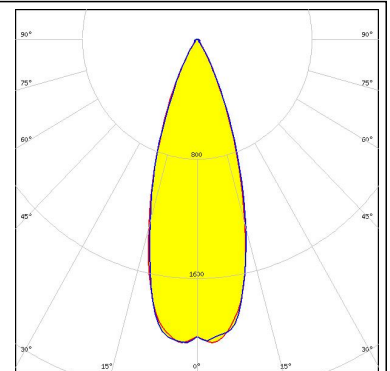

CREE LEDS

LED CMU10xx
 Ordering code CP19134_AMY-50-W-B2
 FWHM / FWTM 34.0° / 60.0°
 Efficiency 86 %
 Peak intensity 2.1 cd/lm
 LEDs/each optic 1
 Light colour White
 Required components:
 BJB: 47.360.1020

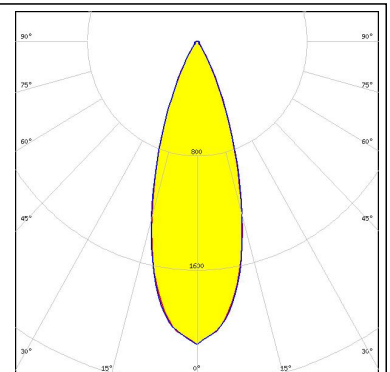

OPTICAL RESULTS (SIMULATED):

LUMILEDS

LED LUXEON CX Plus CoB L08 (Gen2)
Ordering code CP19125_AMY-50-W-C2
FWHM / FWTM 34.0° / 67.0°
Efficiency 87 %
Peak intensity 1.8 cd/lm
LEDs/each optic 1
Light colour White
Required components:
Bender Wirth: 637a Hekla

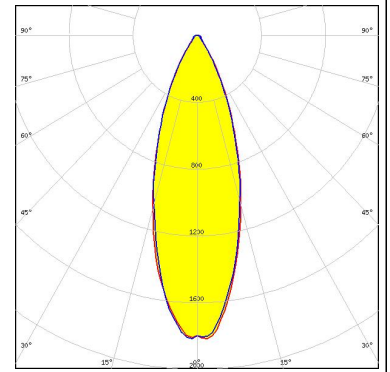

LUMILEDS

LED LUXEON CoB 1202/1203
Ordering code CP19125_AMY-50-W-C2
FWHM / FWTM 34.2° / 59.0°
Efficiency 85 %
Peak intensity 2.1 cd/lm
LEDs/each optic 1
Light colour White
Required components:
F15858_HEKLA-SOCKET-H

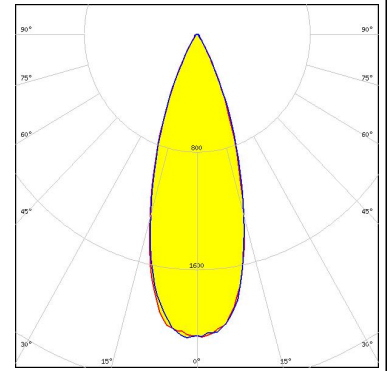

LUMILEDS

LED LUXEON CoB 1204/1205
Ordering code CP19125_AMY-50-W-C2
FWHM / FWTM 35.0° / 64.0°
Efficiency 87 %
Peak intensity 2 cd/lm
LEDs/each optic 1
Light colour White
Required components:
Bender Wirth: 632a Hekla XL

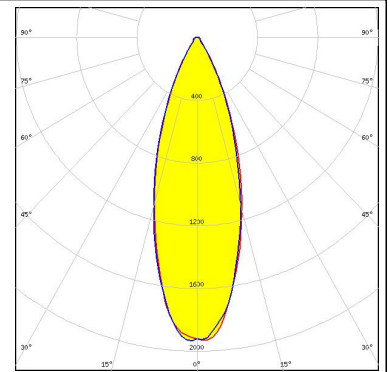

LUMILEDS

LED LUXEON CoB 1205HD
Ordering code CP19125_AMY-50-W-C2
FWHM / FWTM 34.0° / 62.0°
Efficiency 88 %
Peak intensity 2.1 cd/lm
LEDs/each optic 1
Light colour White
Required components:
F15858_HEKLA-SOCKET-H

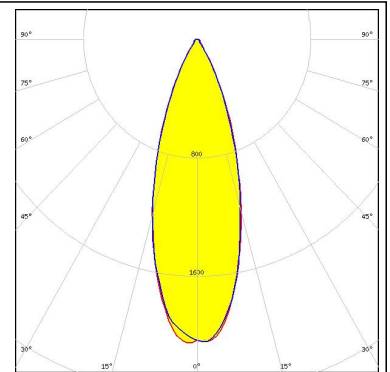

OPTICAL RESULTS (SIMULATED):

LUMILEDS

LED LUXEON CoB 1208
Ordering code CP19125_AMY-50-W-C2
FWHM / FWTM 31.0° / 64.0°
Efficiency 86 %
Peak intensity 2 cd/lm
LEDs/each optic 1
Light colour White
Required components:
Bender Wirth: 632a Hekla XL

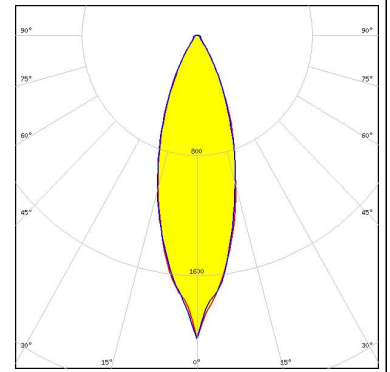

LUMILEDS

LED LUXEON CX Plus CoB - HD S01H4
Ordering code CP19134_AMY-50-W-B2
FWHM / FWTM 37.0° / 56.0°
Efficiency 90 %
Peak intensity 2.2 cd/lm
LEDs/each optic 1
Light colour White
Required components:
Bender Wirth: 634c Bayonet35L

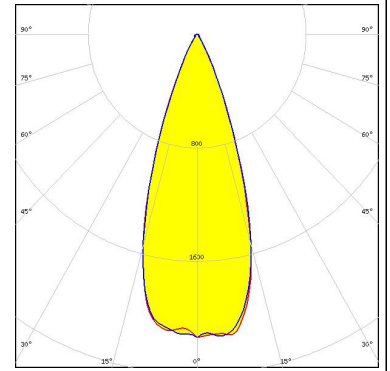

LUMILEDS

LED LUXEON CX Plus CoB - HD S02H6
Ordering code CP19134_AMY-50-W-B2
FWHM / FWTM 36.0° / 58.0°
Efficiency 90 %
Peak intensity 2.2 cd/lm
LEDs/each optic 1
Light colour White
Required components:
Bender Wirth: 634c Bayonet35L

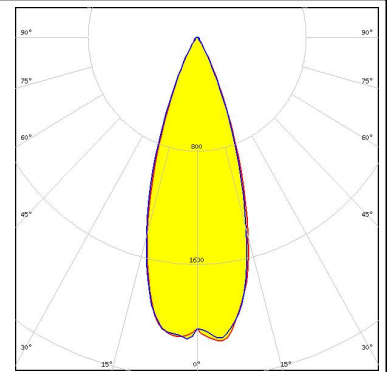

LUMILEDS

LED LUXEON CX Plus CoB - HD S04H9
Ordering code CP19134_AMY-50-W-B2
FWHM / FWTM 34.0° / 60.0°
Efficiency 89 %
Peak intensity 2.2 cd/lm
LEDs/each optic 1
Light colour White
Required components:
Bender Wirth: 634a Bayonet35L

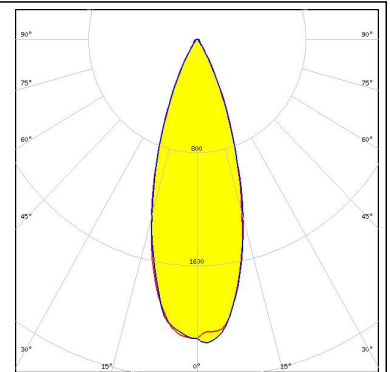

OPTICAL RESULTS (SIMULATED):

LUMILEDS

LED LUXEON CX Plus CoB L04 / L05 (Gen2)
Ordering code CP19125_AMY-50-W-C2
FWHM / FWTM 34.0° / 63.0°
Efficiency 87 %
Peak intensity 2 cd/lm
LEDs/each optic 1
Light colour White
Required components:
F15254_HEKLA-SOCKET-B

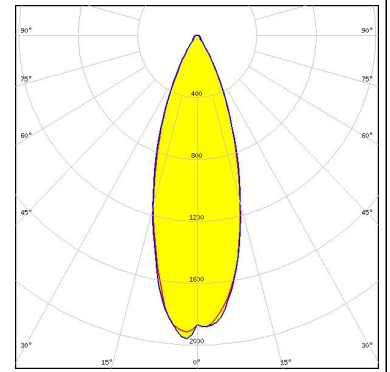

LUMILEDS

LED LUXEON CX Plus CoB M02 / M03 (Gen2)
Ordering code CP19125_AMY-50-W-C2
FWHM / FWTM 34.0° / 60.0°
Efficiency 88 %
Peak intensity 2.2 cd/lm
LEDs/each optic 1
Light colour White
Required components:
F15256_HEKLA-SOCKET-D

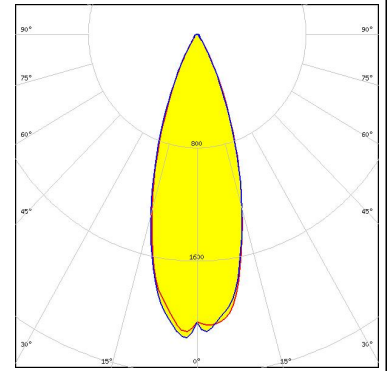

LUMILEDS

LED LUXEON CX Plus CoB S01 (Gen2)
Ordering code CP19125_AMY-50-W-C2
FWHM / FWTM 36.0° / 58.0°
Efficiency 90 %
Peak intensity 2.2 cd/lm
LEDs/each optic 1
Light colour White
Required components:
F15956_HEKLA-SOCKET-J

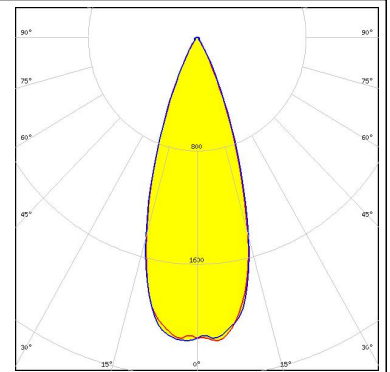

LUMINUS

LED CHM-9 XH (19x19)
Ordering code CP19125_AMY-50-W-C2
FWHM / FWTM 36.0° / 59.0°
Efficiency 89 %
Peak intensity 2.2 cd/lm
LEDs/each optic 1
Light colour White
Required components:
F15859_HEKLA-SOCKET-I

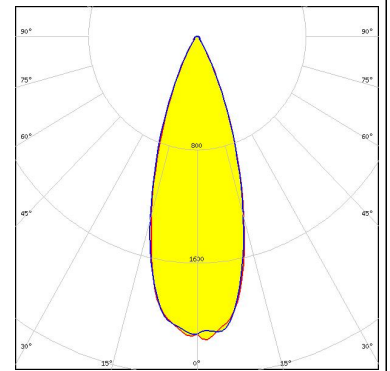

OPTICAL RESULTS (SIMULATED):



LED CTM-6 (Tunable White) Gen2
Ordering code CP19125_AMY-50-W-C2
FWHM / FWTM 36.0° / 58.0°
Efficiency 89 %
Peak intensity 2.2 cd/lm
LEDs/each optic 1
Light colour Tunable White
Required components:
 C16142_HEKLA-SOCKET-K
 Bender Wirth: 495 Typ L8

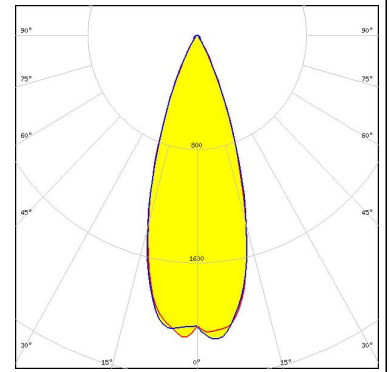

LED CTM-9 (Tunable White) Gen2
Ordering code CP19125_AMY-50-W-C2
FWHM / FWTM 34.0° / 59.0°
Efficiency 88 %
Peak intensity 2.2 cd/lm
LEDs/each optic 1
Light colour Tunable White
Required components:
 C16142_HEKLA-SOCKET-K
 Bender Wirth: 495 Typ L8

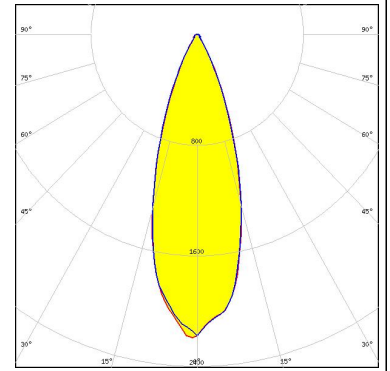

LED CxM-6 (13.5x13.5)
Ordering code CP19134_AMY-50-W-B2
FWHM / FWTM 36.0° / 57.0°
Efficiency 89 %
Peak intensity 2.2 cd/lm
LEDs/each optic 1
Light colour White
Required components:
 BJB: 47.360.1020

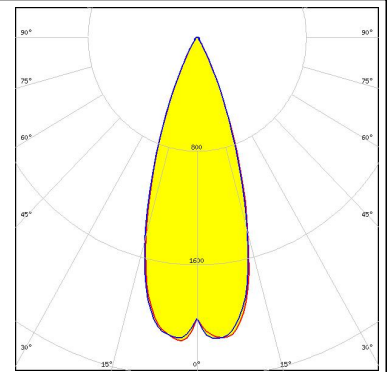

LED COB J-Type
Ordering code CP19125_AMY-50-W-C2
FWHM / FWTM 35.0° / 68.0°
Efficiency 87 %
Peak intensity 1.8 cd/lm
LEDs/each optic 1
Light colour White
Required components:
 Bender Wirth: 663a Hekla XL

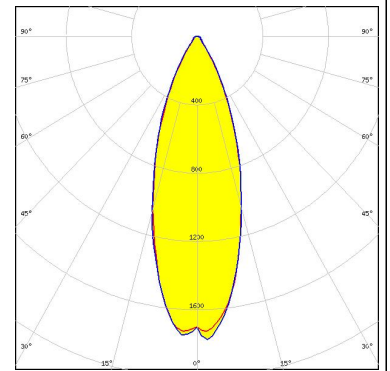

OPTICAL RESULTS (SIMULATED):

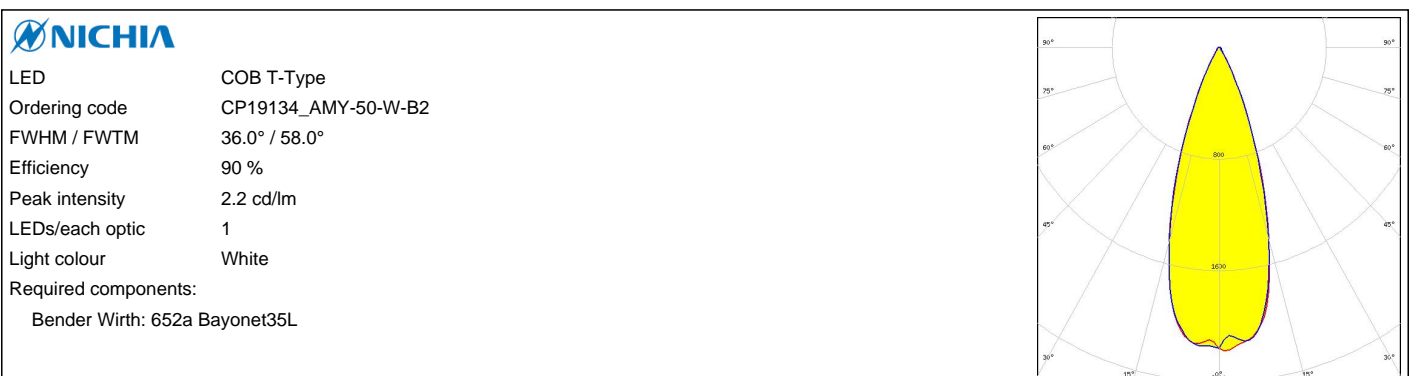
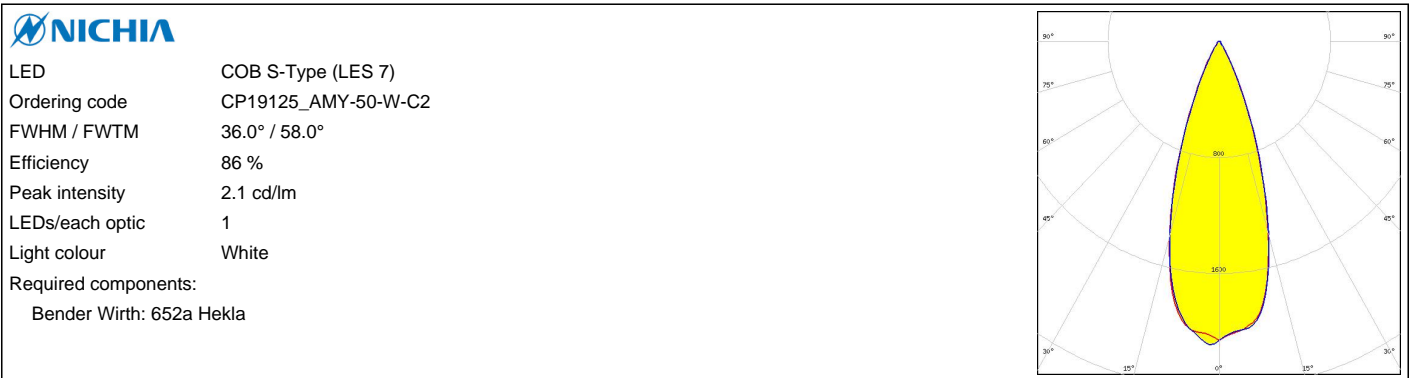

OPTICAL RESULTS (SIMULATED):



LED NJCWL024Z-V1MT: COB L-Type Tunable White
Ordering code CP19125_AMY-50-W-C2
FWHM / FWTM 36.0° / 58.0°
Efficiency 89 %
Peak intensity 2.2 cd/lm
LEDs/each optic 1
Light colour Tunable White
Required components:
 C16142_HEKLA-SOCKET-K
 Bender Wirth: 497 Typ L8 HV

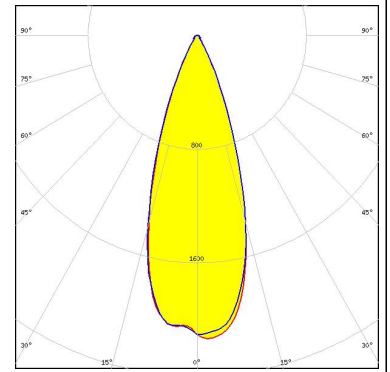

LED NJNWS012Z-V1MT: COB S-Type Tunable White
Ordering code CP19125_AMY-50-W-C2
FWHM / FWTM 36.0° / 56.0°
Efficiency 89 %
Peak intensity 2.2 cd/lm
LEDs/each optic 1
Light colour Tunable White
Required components:
 C16142_HEKLA-SOCKET-K
 Bender Wirth: 495 Typ L8 HV

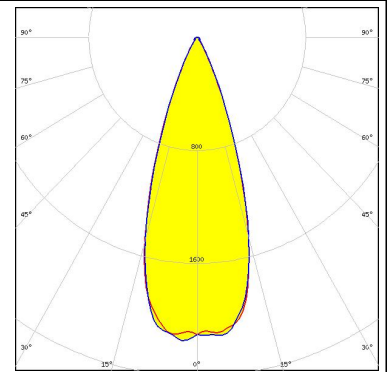

LED NVCWJ024Z-V1MT: COB J-Type Tunable White
Ordering code CP19125_AMY-50-W-C2
FWHM / FWTM 34.0° / 62.0°
Efficiency 87 %
Peak intensity 2.1 cd/lm
LEDs/each optic 1
Light colour Tunable White
Required components:
 C16142_HEKLA-SOCKET-K
 Bender Wirth: 498 Typ L8 HV

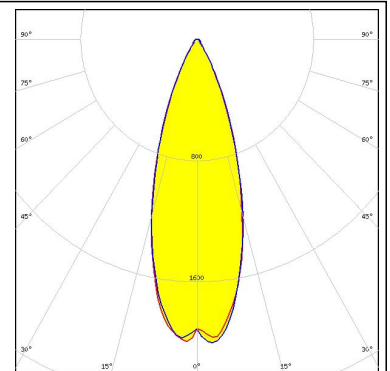

LED LC003D / LC006D / LC009D / LC013D
Ordering code CP19134_AMY-50-W-B2
FWHM / FWTM 34.0° / 60.0°
Efficiency 88 %
Peak intensity 2.2 cd/lm
LEDs/each optic 1
Light colour White
Required components:
 BJB: 47.360.1020

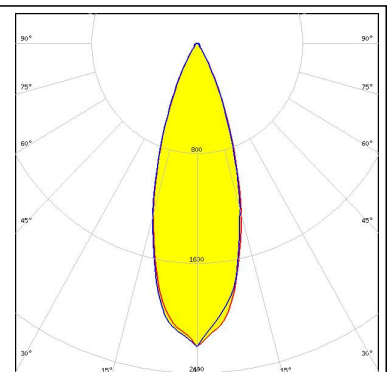

OPTICAL RESULTS (SIMULATED):

SAMSUNG

LED LC003D / LC006D / LC009D / LC013D
Ordering code CP19125_AMY-50-W-C2
FWHM / FWTM 35.2° / 60.3°
Efficiency 84 %
Peak intensity 2 cd/lm
LEDs/each optic 1
Light colour White
Required components:
F15255_HEKLA-SOCKET-C

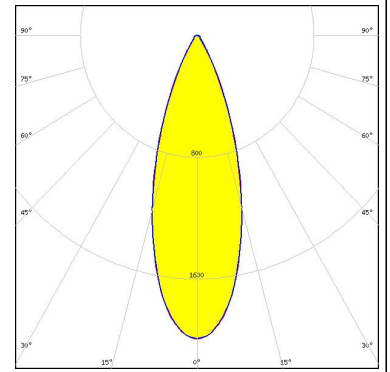

SAMSUNG

LED LC010C G2
Ordering code CP19134_AMY-50-W-B2
FWHM / FWTM 36.0° / 56.0°
Efficiency 89 %
Peak intensity 2.2 cd/lm
LEDs/each optic 1
Light colour White
Required components:
BJB: 47.360.1020

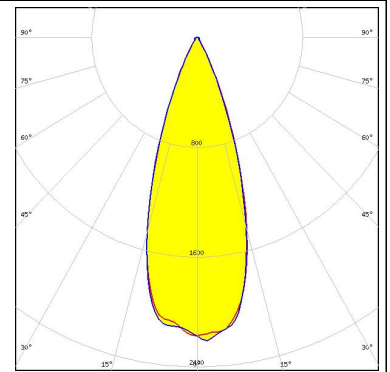

SAMSUNG

LED LC020C G2
Ordering code CP19134_AMY-50-W-B2
FWHM / FWTM 34.0° / 59.0°
Efficiency 87 %
Peak intensity 2.2 cd/lm
LEDs/each optic 1
Light colour White
Required components:
BJB: 47.360.1010

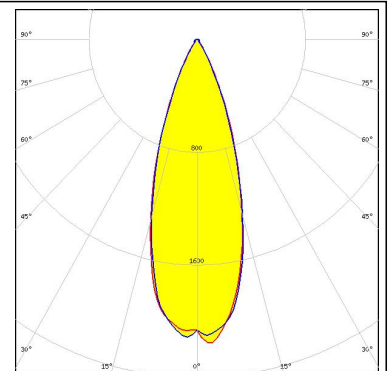

SAMSUNG

LED LC030C/040C G2
Ordering code CP19134_AMY-50-W-B2
FWHM / FWTM 34.0° / 62.0°
Efficiency 86 %
Peak intensity 2.1 cd/lm
LEDs/each optic 1
Light colour White
Required components:
BJB: 47.360.1010

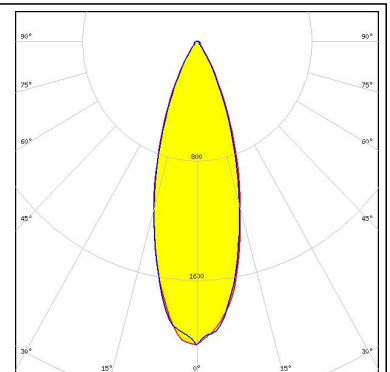

OPTICAL RESULTS (SIMULATED):

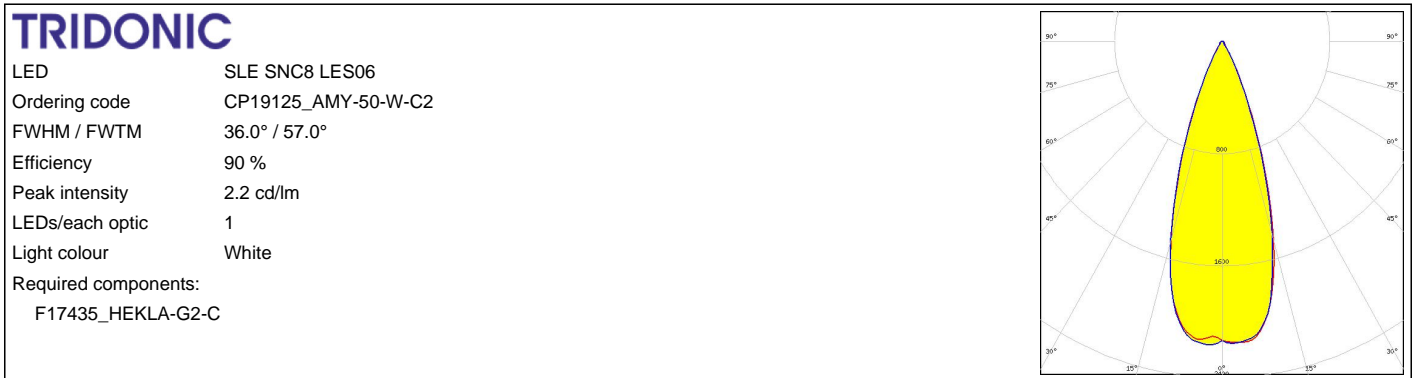

GENERAL INFORMATION:

NOTE: The typical beam angle will be changed by different color, chip size and chip position tolerance. The typical total beam angle is the full angle measured where the luminous intensity is half of the peak value.

Due to use of high power COB's with this product, special attention to proper thermal design is highly recommended. LEDiL has no liability for direct, indirect or consecutive damages arising from the LEDiL products being used outside of the recommended temperature range.

MATERIALS:

As part of our continuous research and improvement processes, and to ensure the best possible quality and availability of our products, LEDiL reserves the right to change material grades without notice.

PRODUCT DATA USER AGREEMENT AND DISCLAIMER:

The measured data in the provided downloadable LEDiL Product Datasheets and Mechanical 2D-Drawings is rounded and provided as reference for planning. LEDiL Oy's optical specifications have been verified by conducting performance testing of the products in accordance with the company's quality system. The reported data are averaged results of multiple measurements with typical variation. LEDiL Oy reserves the right to without prior notification make changes and improvements to its products.

LEDiL Oy assumes neither warranty, nor guarantee nor any other liability of any kind for the contents and correctness of the provided data. The provided data has been generated with highest diligence but the provided data may in reality not represent the complete possible variation range of all intrinsic parameters. Therefore, in certain cases a deviation from the provided data could occur.

LEDiL Oy reserves the right to undertake technical changes of its products without further notification which could lead to changes in the provided data. LEDiL Oy assumes no liability of any kind for the possible deviation from any provided data or any other damage resulting from the usage of the provided data.

The user agrees to this disclaimer and user agreement with the download or usage of the provided files.

LEDiL Oy

Joensuunkatu 13
FI-24240 SALO
Finland

LEDiL Inc.

228 West Page Street
Suite D
Sycamore IL 60178
USA

Ledil Optics Technology (Shenzhen) Co., Ltd.

405 , Block B
Casic Motor Building
Shenzhen 518057
P.R.CHINA

Local sales and technical support

[www.ledil.com/
where_to_buy](http://www.ledil.com/where_to_buy)

Shipping locations

Salo, Finland
Hong Kong, China

Distribution Partners

[www.ledil.com/
where_to_buy](http://www.ledil.com/where_to_buy)