

AMY-50-RS

~15° spot beam with tight cutoff

SPECIFICATION:

Dimensions	Ø 49.9 mm
Height	11 mm
Fastening	socket
ROHS compliant	yes ⓘ

MATERIALS:

Component	Type	Material	Colour	Finish
AMY-50-RS	Single lens	PMMA	clear	
AMY-50-HLD2-C	Holder C	PC	black	
AMY-50-HLD2-B	Holder B	PC	black	
AMY-50-HLD2-C-WHT	Holder C	PC	white	
AMY-50-HLD2-B-WHT	Holder B	PC	white	



ORDERING INFORMATION:

Component	Qty in box	MOQ	MPQ	Box weight (kg)
C18515_AMY-50-RS	690	120	30	9.7
Assembly				
CP19160_AMY-50-RS-B2-WHT	510	120	30	8.9
CP19149_AMY-50-RS-C2-WHT	510	120	30	8.5
CP19140_AMY-50-RS-B2	510	120	30	8.9
CP19131_AMY-50-RS-C2	510	120	30	8.5

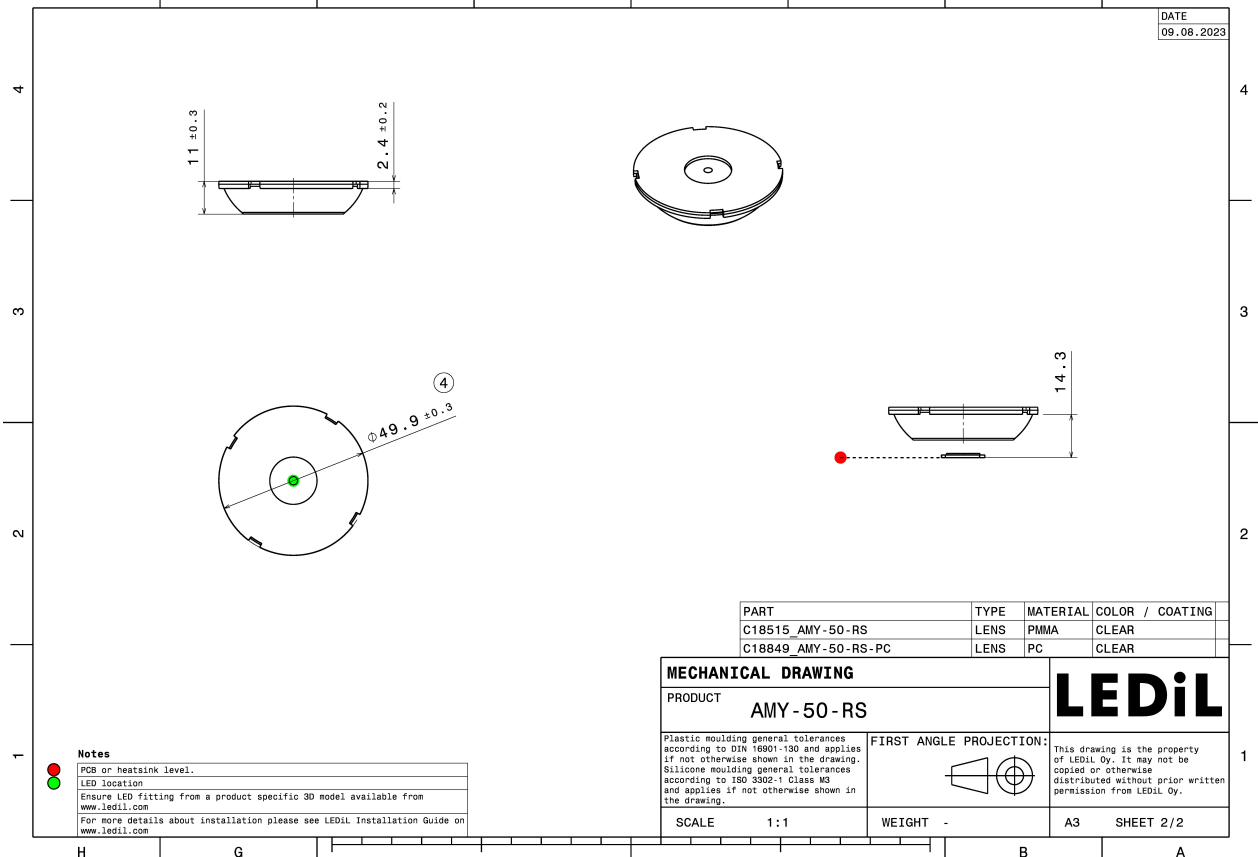
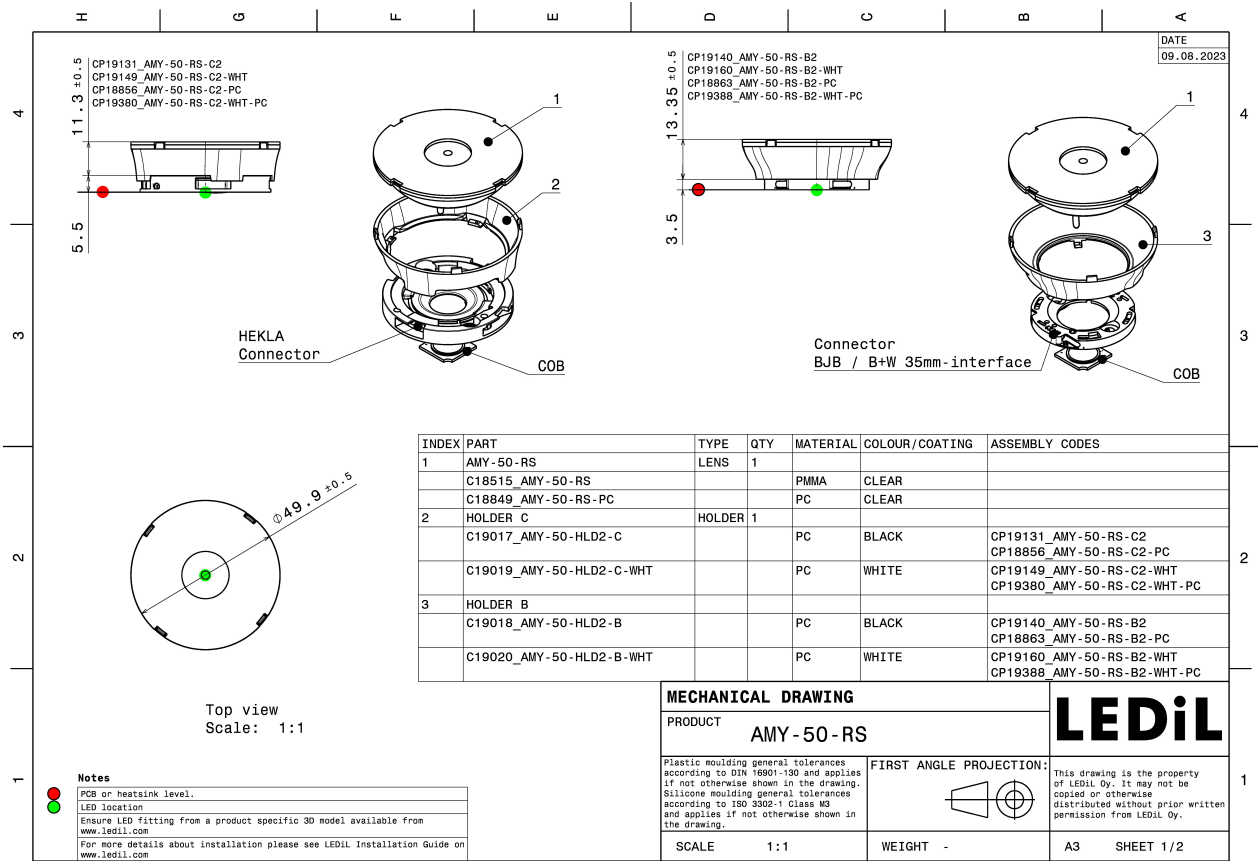

See also our general installation guide: www.ledil.com/installation_guide

OPTICAL RESULTS (MEASURED):

CITIZEN

LED CLL02x/CLU02x (LES10)
Ordering code CP19140_AMY-50-RS-B2
FWHM / FWTM 17.0° / 31.0°
Efficiency 85 %
LEDs/each optic 1
Light colour White
Required components:
F17435_HEKLA-G2-C

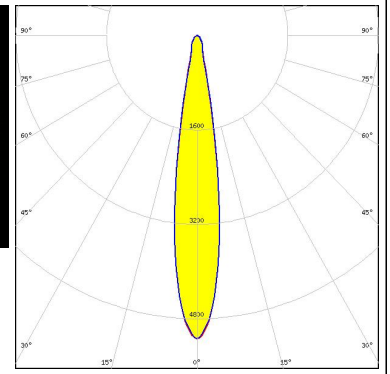

CITIZEN

LED CLU700/701/702/703
Ordering code CP19140_AMY-50-RS-B2
FWHM / FWTM 11.0° / 19.0°
Efficiency 87 %
LEDs/each optic 1
Light colour White
Required components:
F17435_HEKLA-G2-C

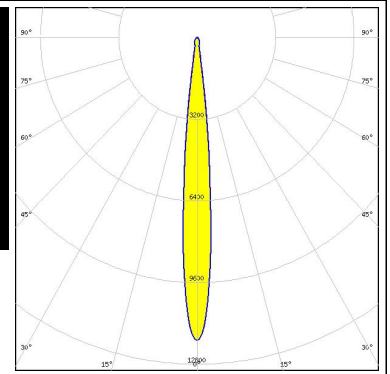
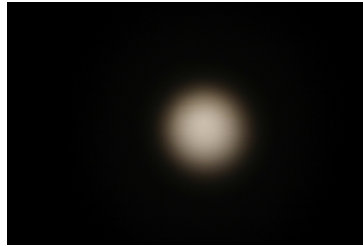

OPTICAL RESULTS (SIMULATED):

bridgelux

LED V3 HD Gen 8
 Ordering code CP19140_AMY-50-RS-B2
 FWHM / FWTM 8.0° / 16.0°
 Efficiency 89 %
 Peak intensity 20.9 cd/lm
 LEDs/each optic 1
 Light colour White
 Required components:
 F15253_HEKLA-SOCKET-A

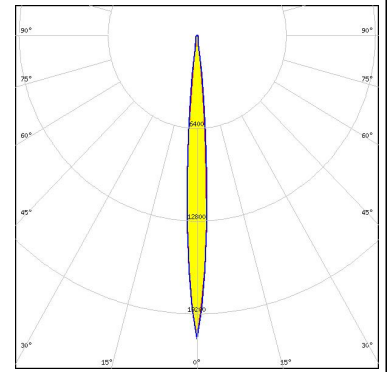

bridgelux

LED V4 HD Gen 7
 Ordering code CP19140_AMY-50-RS-B2
 FWHM / FWTM 8.0° / 16.0°
 Efficiency 87 %
 Peak intensity 19.2 cd/lm
 LEDs/each optic 1
 Light colour White
 Required components:
 F15253_HEKLA-SOCKET-A

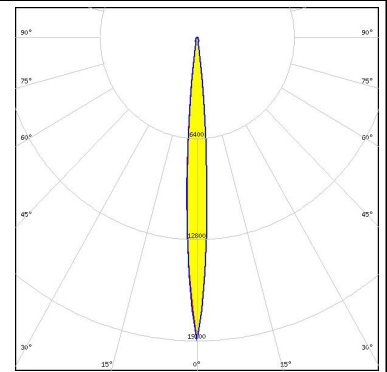

bridgelux

LED V4 HD Gen 8
 Ordering code CP19140_AMY-50-RS-B2
 FWHM / FWTM 8.0° / 16.0°
 Efficiency 87 %
 Peak intensity 18.6 cd/lm
 LEDs/each optic 1
 Light colour White
 Required components:
 F15253_HEKLA-SOCKET-A

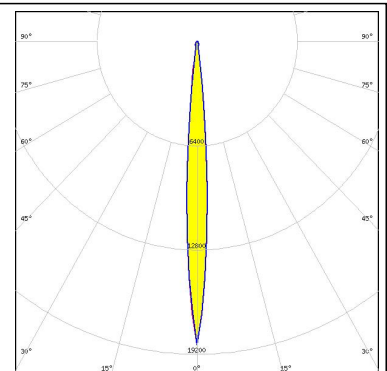

bridgelux

LED V6 HD Gen 7
 Ordering code CP19140_AMY-50-RS-B2
 FWHM / FWTM 10.0° / 20.0°
 Efficiency 86 %
 Peak intensity 12.5 cd/lm
 LEDs/each optic 1
 Light colour White
 Required components:
 F15255_HEKLA-SOCKET-C

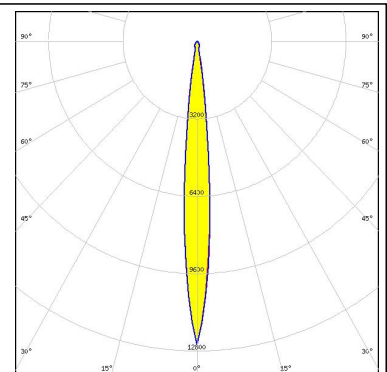

OPTICAL RESULTS (SIMULATED):



LED VERO13
Ordering code CP19140_AMY-50-RS-B2
FWHM / FWTM 22.0° / 42.0°
Efficiency 87 %
Peak intensity 3.4 cd/lm
LEDs/each optic 1
Light colour White
Required components:
 C16142_HEKLA-SOCKET-K

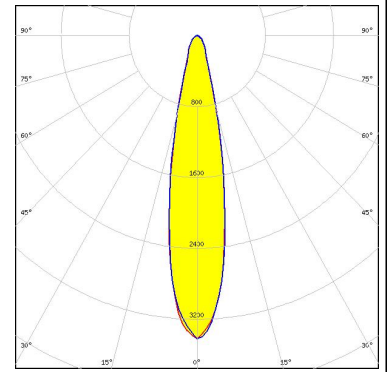

LED Vesta DTW 6mm
Ordering code CP19140_AMY-50-RS-B2
FWHM / FWTM 12.0° / 22.0°
Efficiency 88 %
Peak intensity 9.3 cd/lm
LEDs/each optic 1
Light colour White
Required components:
 Bender Wirth: 652b Hekla

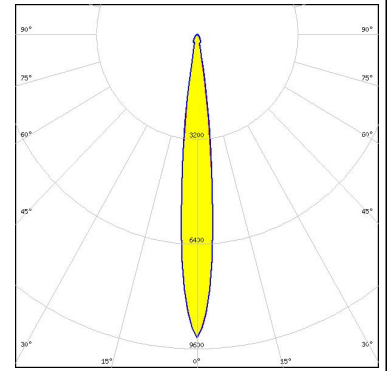

LED Vesta SE 13mm TW
Ordering code CP19131_AMY-50-RS-C2
FWHM / FWTM 26.0° / 46.0°
Efficiency 79 %
Peak intensity 2.6 cd/lm
LEDs/each optic 1
Light colour Tunable White
Required components:
 C16142_HEKLA-SOCKET-K

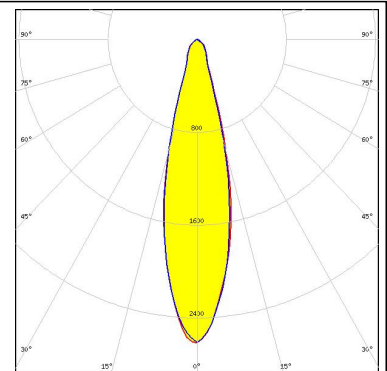

LED LUXEON CX Plus CoB L08 (Gen2)
Ordering code CP19131_AMY-50-RS-C2
FWHM / FWTM 28.0° / 50.0°
Efficiency 86 %
Peak intensity 2.6 cd/lm
LEDs/each optic 1
Light colour White
Required components:
 Bender Wirth: 637a Hekla

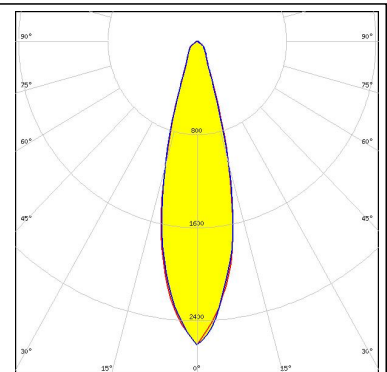

OPTICAL RESULTS (SIMULATED):

LUMILEDS

LED LUXEON 7070
 Ordering code C18515_AMY-50-RS
 FWHM / FWTM 11.0° / 20.0°
 Efficiency 91 %
 Peak intensity 10.9 cd/lm
 LEDs/each optic 1
 Light colour White
 Required components:

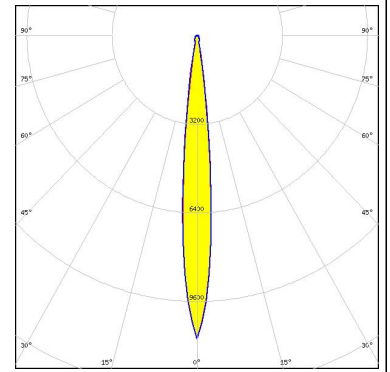

LUMILEDS

LED LUXEON CoB 1204HD
 Ordering code CP19140_AMY-50-RS-B2
 FWHM / FWTM 16.0° / 30.0°
 Efficiency 87 %
 Peak intensity 5.8 cd/lm
 LEDs/each optic 1
 Light colour White
 Required components:
 F15858_HEKLA-SOCKET-H

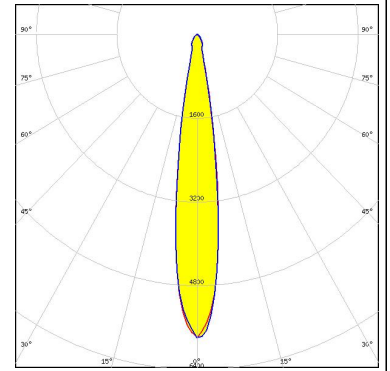

LUMILEDS

LED LUXEON CX Plus CoB - HD S01H4
 Ordering code CP19140_AMY-50-RS-B2
 FWHM / FWTM 9.0° / 18.0°
 Efficiency 87 %
 Peak intensity 15.8 cd/lm
 LEDs/each optic 1
 Light colour White
 Required components:
 Bender Wirth: 634c Bayonet35L

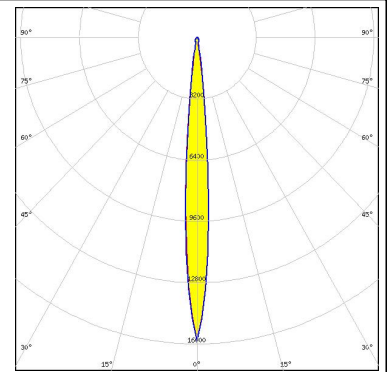

LUMILEDS

LED LUXEON CX Plus CoB - HD S02H6
 Ordering code CP19140_AMY-50-RS-B2
 FWHM / FWTM 12.0° / 22.0°
 Efficiency 88 %
 Peak intensity 10.2 cd/lm
 LEDs/each optic 1
 Light colour White
 Required components:
 Bender Wirth: 634c Bayonet35L

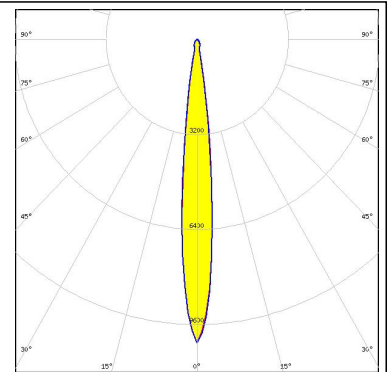

OPTICAL RESULTS (SIMULATED):

LUMILEDS

LED LUXEON CX Plus CoB - HD S04H9
 Ordering code CP19140_AMY-50-RS-B2
 FWHM / FWTM 17.0° / 30.0°
 Efficiency 87 %
 Peak intensity 5.5 cd/lm
 LEDs/each optic 1
 Light colour White
 Required components:
 Bender Wirth: 634a Bayonet35L

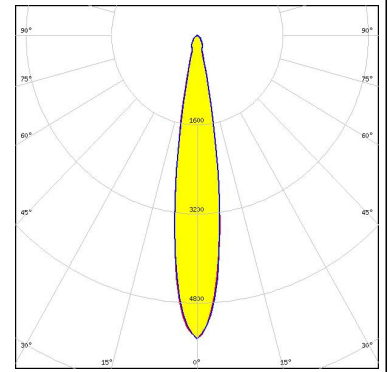

LUMILEDS

LED LUXEON CX Plus CoB S01 (Gen2)
 Ordering code CP19131_AMY-50-RS-C2
 FWHM / FWTM 10.0° / 20.0°
 Efficiency 88 %
 Peak intensity 11.8 cd/lm
 LEDs/each optic 1
 Light colour White
 Required components:
 F15956_HEKLA-SOCKET-J

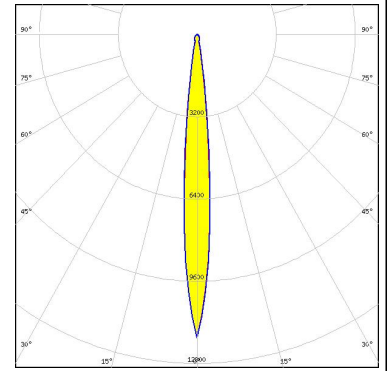

LUMINUS

LED CHM-9 XH (19x19)
 Ordering code CP19131_AMY-50-RS-C2
 FWHM / FWTM 14.0° / 27.0°
 Efficiency 87 %
 Peak intensity 6.8 cd/lm
 LEDs/each optic 1
 Light colour White
 Required components:
 F15859_HEKLA-SOCKET-I

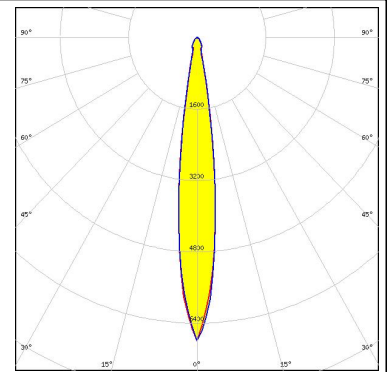

LUMINUS

LED CTM-14 (Tunable White) Gen2
 Ordering code CP19131_AMY-50-RS-C2
 FWHM / FWTM 24.0° / 46.0°
 Efficiency 85 %
 Peak intensity 2.9 cd/lm
 LEDs/each optic 1
 Light colour Tunable White
 Required components:
 C16142_HEKLA-SOCKET-K
 Bender Wirth: 442 Typ L8

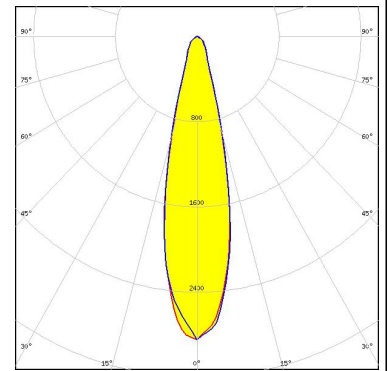

OPTICAL RESULTS (SIMULATED):



LED CTM-6 (Tunable White) Gen2
Ordering code CP19131_AMY-50-RS-C2
FWHM / FWTM 12.0° / 22.0°
Efficiency 87 %
Peak intensity 9.3 cd/lm
LEDs/each optic 1
Light colour Tunable White
Required components:
 C16142_HEKLA-SOCKET-K
 Bender Wirth: 495 Typ L8

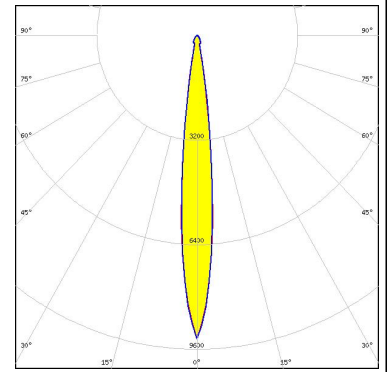

LED CTM-9 (Tunable White) Gen2
Ordering code CP19131_AMY-50-RS-C2
FWHM / FWTM 16.0° / 28.0°
Efficiency 86 %
Peak intensity 6 cd/lm
LEDs/each optic 1
Light colour Tunable White
Required components:
 C16142_HEKLA-SOCKET-K
 Bender Wirth: 495 Typ L8

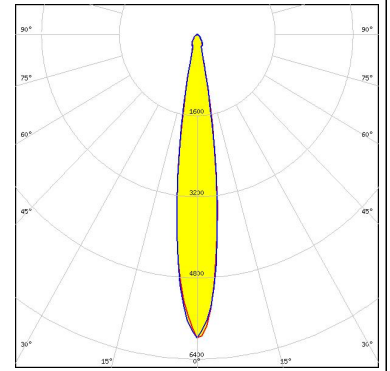

LED CxM-6 (13.5x13.5)
Ordering code CP19140_AMY-50-RS-B2
FWHM / FWTM 11.0° / 20.0°
Efficiency 87 %
Peak intensity 10.9 cd/lm
LEDs/each optic 1
Light colour White
Required components:
 BJB: 47.360.1020

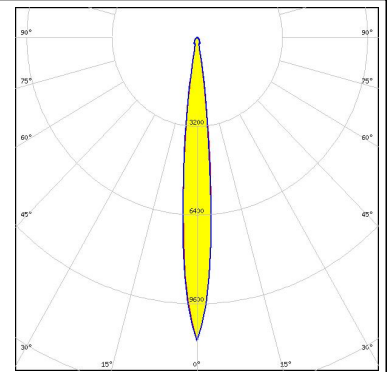

LED COB J-Type
Ordering code CP19131_AMY-50-RS-C2
FWHM / FWTM 27.0° / 50.0°
Efficiency 86 %
Peak intensity 2.6 cd/lm
LEDs/each optic 1
Light colour White
Required components:
 Bender Wirth: 663a Hekla XL

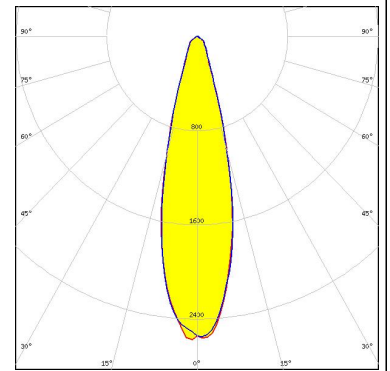

OPTICAL RESULTS (SIMULATED):



LED COB L-Type (LES 9)
Ordering code CP19131_AMY-50-RS-C2
FWHM / FWTM 14.0° / 28.0°
Efficiency 87 %
Peak intensity 6.6 cd/lm
LEDs/each optic 1
Light colour White
Required components:
F15858_HEKLA-SOCKET-H

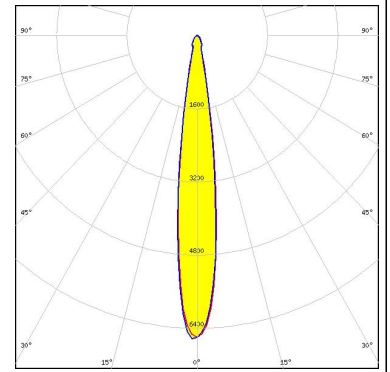

LED COB S-Type (LES 6)
Ordering code CP19140_AMY-50-RS-B2
FWHM / FWTM 10.0° / 20.0°
Efficiency 88 %
Peak intensity 12.7 cd/lm
LEDs/each optic 1
Light colour White
Required components:
Bender Wirth: 652a Bayonet35L

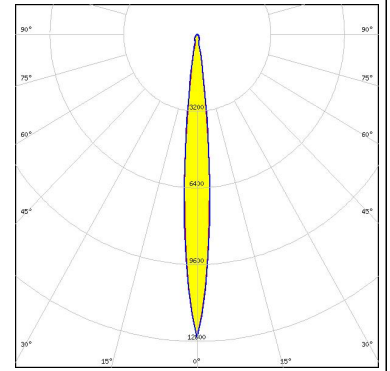

LED COB S-Type (LES 7)
Ordering code CP19140_AMY-50-RS-B2
FWHM / FWTM 12.0° / 22.0°
Efficiency 88 %
Peak intensity 10.2 cd/lm
LEDs/each optic 1
Light colour White
Required components:
Bender Wirth: 652a Bayonet35L

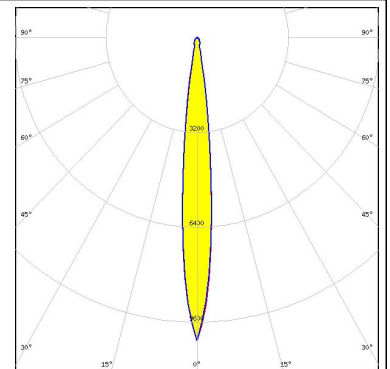

LED COB S-Type (LES 7)
Ordering code CP19140_AMY-50-RS-B2
FWHM / FWTM 12.0° / 22.0°
Efficiency 84 %
Peak intensity 9.6 cd/lm
LEDs/each optic 1
Light colour White
Required components:
Bender Wirth: 652a Hekla

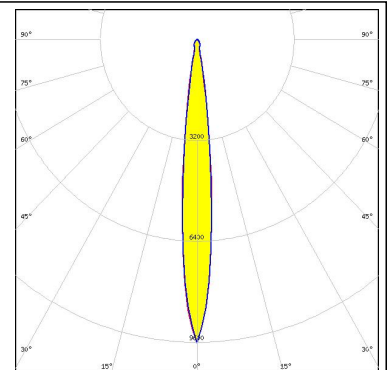

OPTICAL RESULTS (SIMULATED):



LED NJCWL024Z-V1MT: COB L-Type Tunable White
Ordering code CP19131_AMY-50-RS-C2
FWHM / FWTM 12.0° / 23.0°
Efficiency 86 %
Peak intensity 8.8 cd/lm
LEDs/each optic 1
Light colour Tunable White
Required components:
 C16142_HEKLA-SOCKET-K
 Bender Wirth: 497 Typ L8 HV

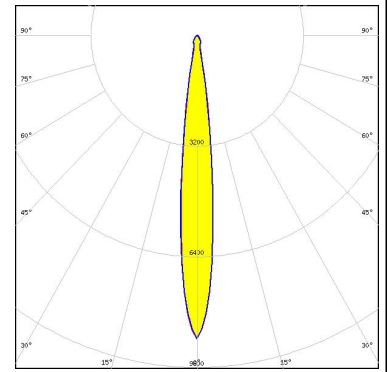

LED NJNWS012Z-V1MT: COB S-Type Tunable White
Ordering code CP19131_AMY-50-RS-C2
FWHM / FWTM 10.0° / 18.0°
Efficiency 87 %
Peak intensity 13.7 cd/lm
LEDs/each optic 1
Light colour Tunable White
Required components:
 C16142_HEKLA-SOCKET-K
 Bender Wirth: 495 Typ L8 HV

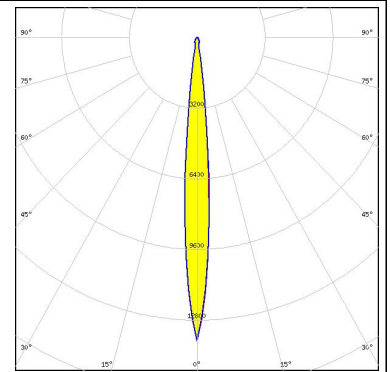

LED NVCWJ024Z-V1MT: COB J-Type Tunable White
Ordering code CP19131_AMY-50-RS-C2
FWHM / FWTM 18.0° / 34.0°
Efficiency 85 %
Peak intensity 4.6 cd/lm
LEDs/each optic 1
Light colour Tunable White
Required components:
 C16142_HEKLA-SOCKET-K
 Bender Wirth: 498 Typ L8 HV

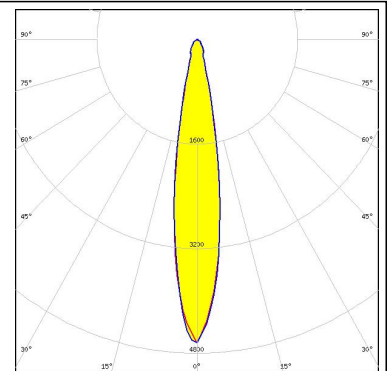

LED LC003D / LC006D / LC009D / LC013D
Ordering code CP19140_AMY-50-RS-B2
FWHM / FWTM 16.0° / 30.0°
Efficiency 86 %
Peak intensity 5.9 cd/lm
LEDs/each optic 1
Light colour White
Required components:
 BJB: 47.360.1020

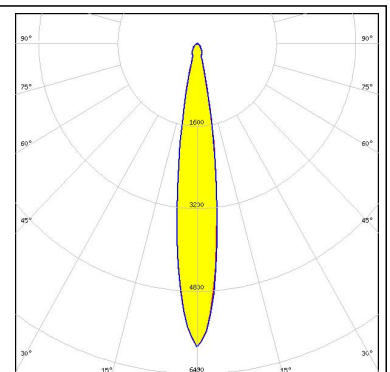

OPTICAL RESULTS (SIMULATED):

SAMSUNG

LED LC010C G2
Ordering code CP19140_AMY-50-RS-B2
FWHM / FWTM 10.0° / 20.0°
Efficiency 87 %
Peak intensity 11.6 cd/lm
LEDs/each optic 1
Light colour White
Required components:
BJB: 47.360.1020

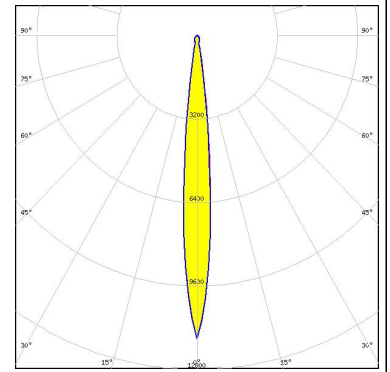

SAMSUNG

LED LC010T (Tunable White)
Ordering code CP19131_AMY-50-RS-C2
FWHM / FWTM 14.0° / 26.0°
Efficiency 86 %
Peak intensity 7.4 cd/lm
LEDs/each optic 1
Light colour Tunable White
Required components:
C16142_HEKLA-SOCKET-K
Bender Wirth: 501 Typ L8

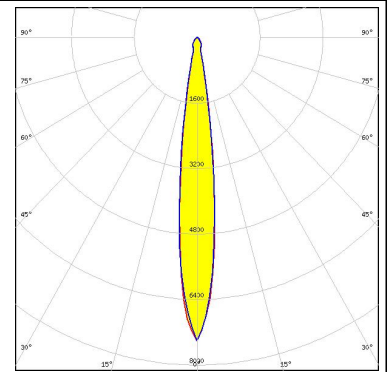

SAMSUNG

LED LC016D / LC019D / LC026D / LC033D
Ordering code CP19140_AMY-50-RS-B2
FWHM / FWTM 26.0° / 50.0°
Efficiency 83 %
Peak intensity 2.6 cd/lm
LEDs/each optic 1
Light colour White
Required components:
BJB: 47.360.1010

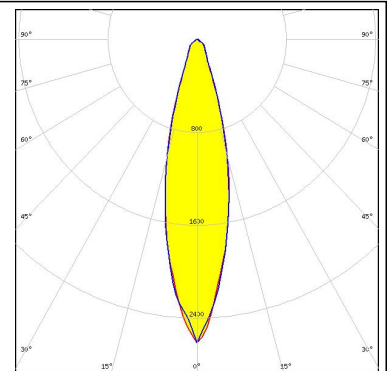

SAMSUNG

LED LC030C/040C G2
Ordering code CP19140_AMY-50-RS-B2
FWHM / FWTM 20.0° / 39.0°
Efficiency 84 %
Peak intensity 3.8 cd/lm
LEDs/each optic 1
Light colour White
Required components:
BJB: 47.360.1010

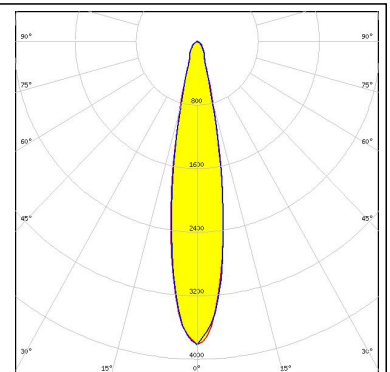

OPTICAL RESULTS (SIMULATED):



GENERAL INFORMATION:

NOTE: The typical beam angle will be changed by different color, chip size and chip position tolerance. The typical total beam angle is the full angle measured where the luminous intensity is half of the peak value.

Due to use of high power COB's with this product, special attention to proper thermal design is highly recommended. LEDiL has no liability for direct, indirect or consecutive damages arising from the LEDiL products being used outside of the recommended temperature range.

MATERIALS:

As part of our continuous research and improvement processes, and to ensure the best possible quality and availability of our products, LEDiL reserves the right to change material grades without notice.

PRODUCT DATA USER AGREEMENT AND DISCLAIMER:

The measured data in the provided downloadable LEDiL Product Datasheets and Mechanical 2D-Drawings is rounded and provided as reference for planning. LEDiL Oy's optical specifications have been verified by conducting performance testing of the products in accordance with the company's quality system. The reported data are averaged results of multiple measurements with typical variation. LEDiL Oy reserves the right to without prior notification make changes and improvements to its products.

LEDiL Oy assumes neither warranty, nor guarantee nor any other liability of any kind for the contents and correctness of the provided data. The provided data has been generated with highest diligence but the provided data may in reality not represent the complete possible variation range of all intrinsic parameters. Therefore, in certain cases a deviation from the provided data could occur.

LEDiL Oy reserves the right to undertake technical changes of its products without further notification which could lead to changes in the provided data. LEDiL Oy assumes no liability of any kind for the possible deviation from any provided data or any other damage resulting from the usage of the provided data.

The user agrees to this disclaimer and user agreement with the download or usage of the provided files.

LEDiL Oy

Joensuunkatu 13
FI-24240 SALO
Finland

LEDiL Inc.

228 West Page Street
Suite D
Sycamore IL 60178
USA

Ledil Optics Technology (Shenzhen) Co., Ltd.

405 , Block B
Casic Motor Building
Shenzhen 518057
P.R.CHINA

Local sales and technical support

[www.ledil.com/
where_to_buy](http://www.ledil.com/where_to_buy)

Shipping locations

Salo, Finland
Hong Kong, China

Distribution Partners

[www.ledil.com/
where_to_buy](http://www.ledil.com/where_to_buy)