

AMY-45-WW

~60° wide beam

SPECIFICATION:

Dimensions	Ø
Height	0 mm
Fastening	screw
ROHS compliant	yes ⓘ

MATERIALS:

Component	Type	Material	Colour	Finish	Length
AMY-45-WW	Single lens	PMMA			45.0



ORDERING INFORMATION:

Component	Qty in box	MOQ	MPQ	Box weight (kg)
C17793_AMY-45-WW	1035	180	45	8.8
Assembly				
CP19631_AMY-45-WW-B-WHT	900	180	45	10.2
CP19626_AMY-45-WW-B	900	180	45	10.2

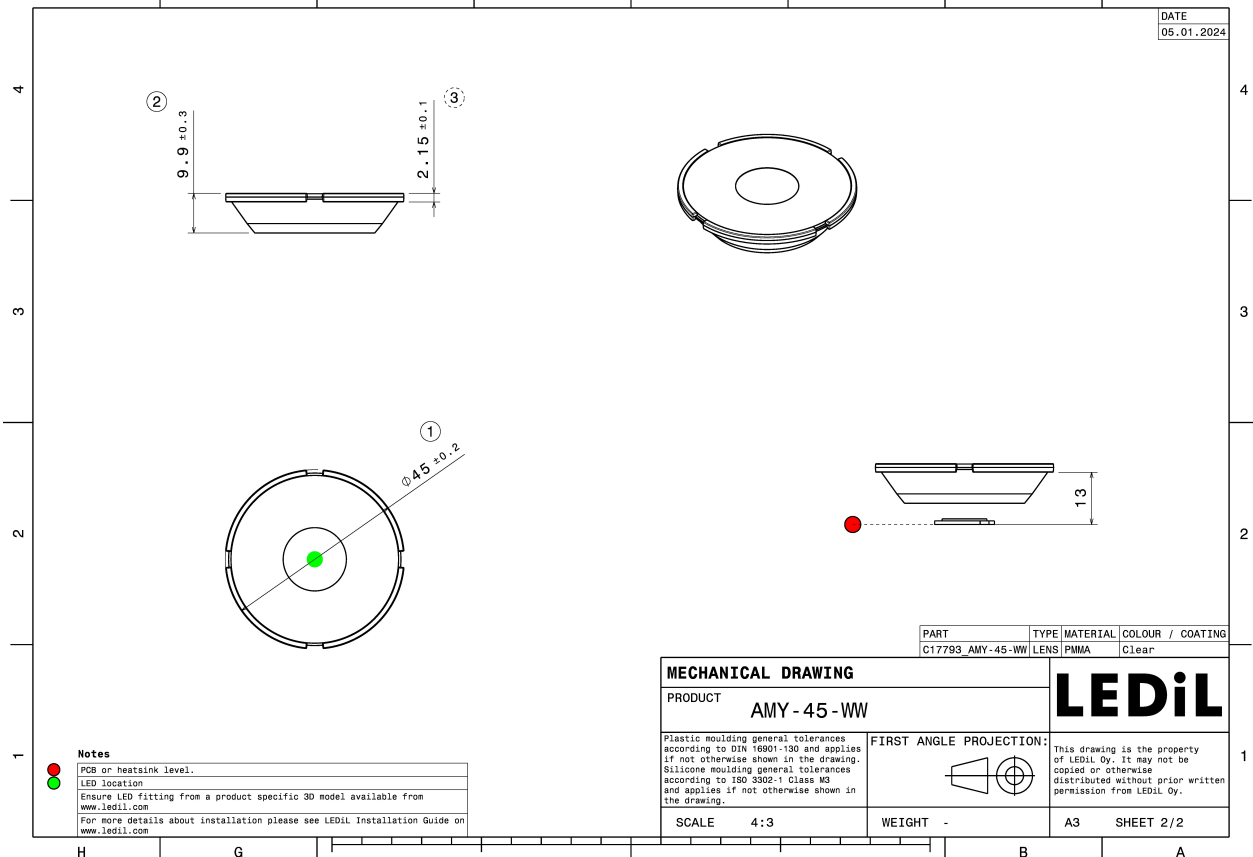
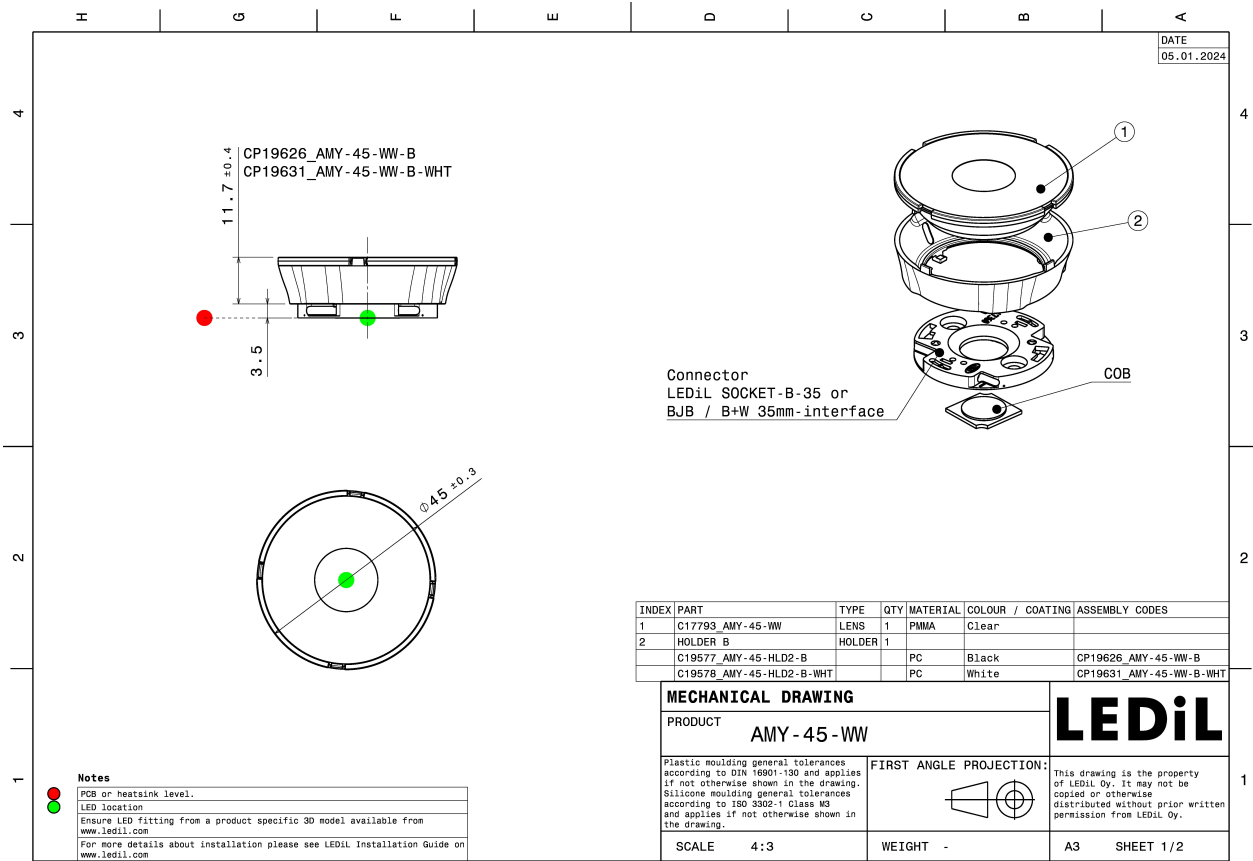

See also our general installation guide: www.ledil.com/installation_guide

OPTICAL RESULTS (MEASURED):



LED V11 HD Gen 8
Ordering code C17793_AMY-45-WW
FWHM / FWTM 56.0° / 78.0°
Efficiency 93 %
LEDs/each optic 1
Light colour/type White
Required components:
Bender Wirth: 633d Hekla

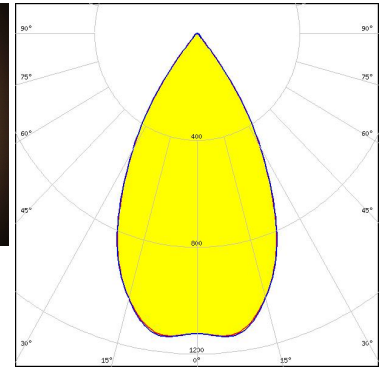
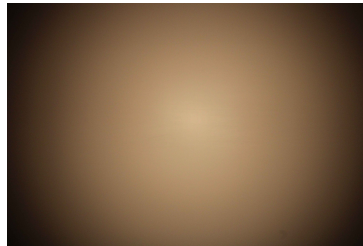

LED V6 HD Gen 7
Ordering code C17793_AMY-45-WW
FWHM / FWTM 56.0° / 74.0°
Efficiency 91 %
LEDs/each optic 1
Light colour/type White
Required components:
F15255_HEKLA-SOCKET-C

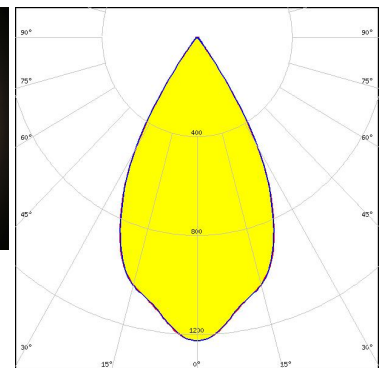
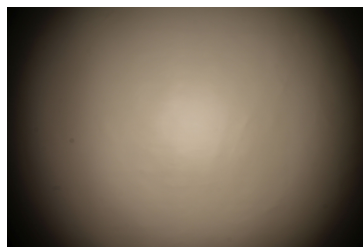



LED V9 HD Gen7
Ordering code C17793_AMY-45-WW
FWHM / FWTM 55.0° / 75.0°
Efficiency 89 %
LEDs/each optic 1
Light colour/type White
Required components:
F15859_HEKLA-SOCKET-I

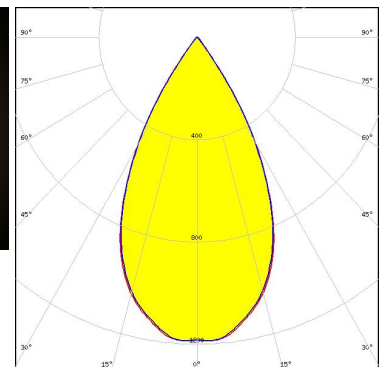
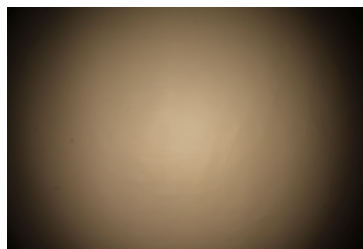

OPTICAL RESULTS (MEASURED):

CITIZEN

LED CLL02x/CLU02x (LES10)
Ordering code C17793_AMY-45-WW
FWHM / FWTM 54.0° / 76.0°
Efficiency 89 %
Peak intensity 1.2 cd/lm
LEDs/each optic 1
Light colour/type White
Required components:
F17435_HEKLA-G2-C

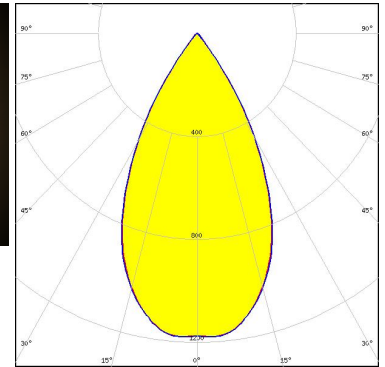
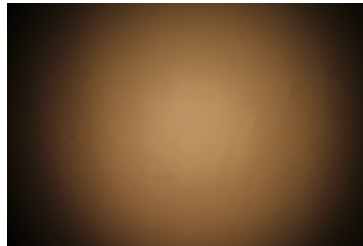

Light distribution files

CITIZEN

LED CLL02x/CLU02x (LES10)
Ordering code C17793_AMY-45-WW
FWHM / FWTM 54.0° / 76.0°
Efficiency 89 %
LEDs/each optic 1
Light colour/type White
Required components:
F17435_HEKLA-G2-C

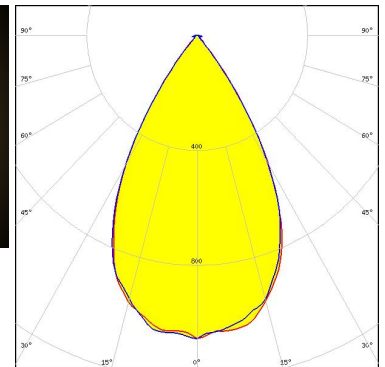
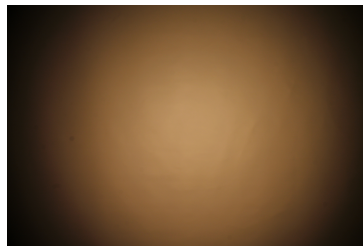

CITIZEN

LED CLU700/701/702/703
Ordering code C17793_AMY-45-WW
FWHM / FWTM 56.0° / 73.0°
Efficiency 90 %
LEDs/each optic 1
Light colour/type White
Required components:
F17435_HEKLA-G2-C

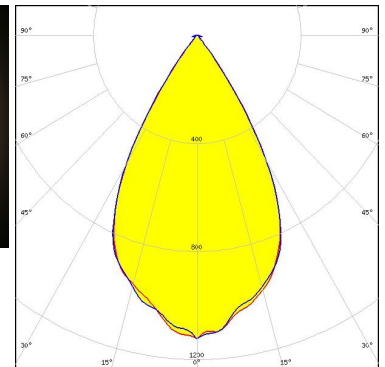
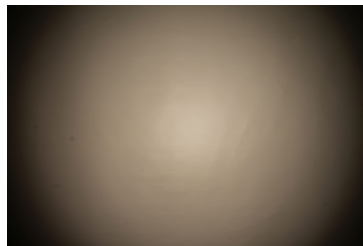

OPTICAL RESULTS (MEASURED):

CITIZEN

LED CLU700/701/702/703
Ordering code C17793_AMY-45-WW
FWHM / FWTM 56.0° / 73.0°
Efficiency 90 %
Peak intensity 1.2 cd/lm
LEDs/each optic 1
Light colour/type White
Required components:
F17435_HEKLA-G2-C

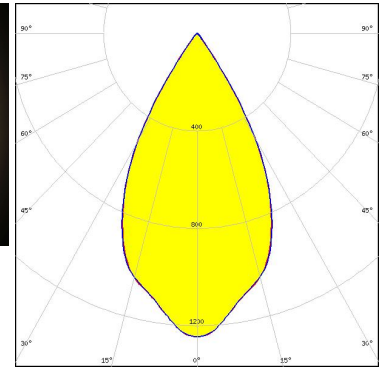
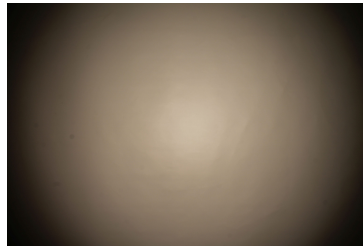

Light distribution files



LED CMA1516
Ordering code C17793_AMY-45-WW
FWHM / FWTM 56.0° / 76.0°
Efficiency 90 %
LEDs/each optic 1
Light colour/type White
Required components:
F17436_HEKLA-G2-D

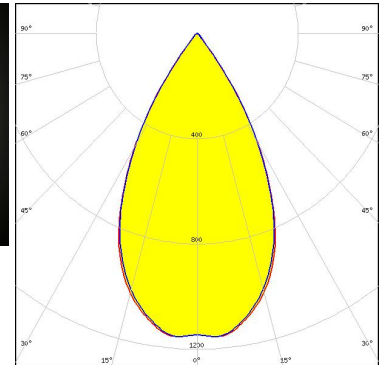

LED CMT14xx
Ordering code C17793_AMY-45-WW
FWHM / FWTM 55.0° / 76.0°
Efficiency 90 %
LEDs/each optic 1
Light colour/type White
Required components:
F17435_HEKLA-G2-C

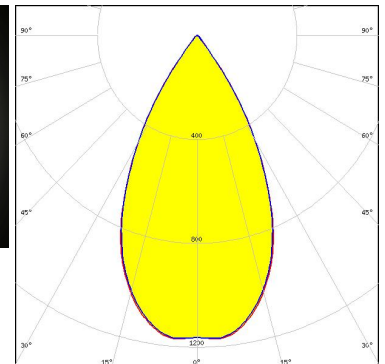
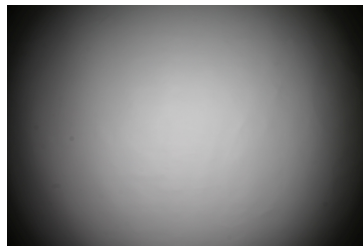

OPTICAL RESULTS (MEASURED):



LED CMU10xx
Ordering code C17793_AMY-45-WW
FWHM / FWTM 56.0° / 78.0°
Efficiency 93 %
LEDs/each optic 1
Light colour/type White
Required components:
BJB: 47.360.1020

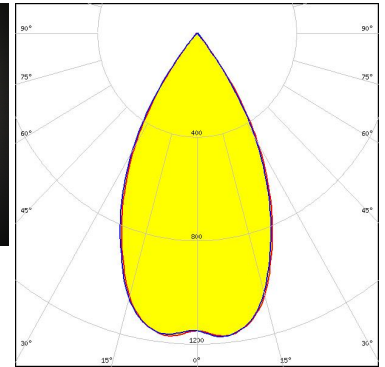
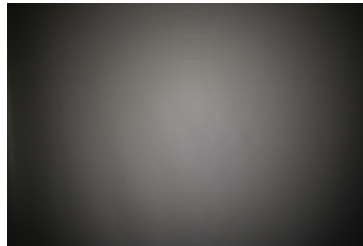

LED LUXEON CoB 1202/1203
Ordering code C17793_AMY-45-WW
FWHM / FWTM 54.0° / 75.0°
Efficiency 89 %
LEDs/each optic 1
Light colour/type White
Required components:
F17437_HEKLA-G2-H

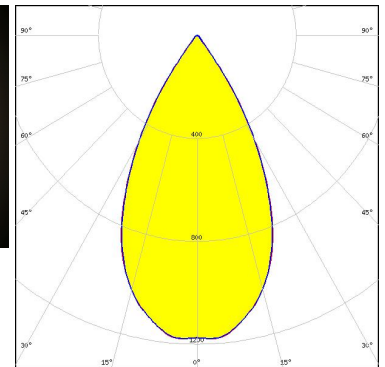
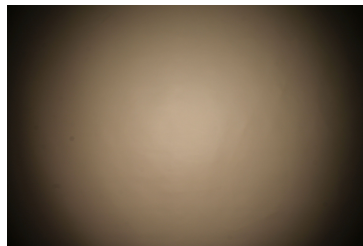

LED LUXEON CoB 1202s
Ordering code C17793_AMY-45-WW
FWHM / FWTM 57.0° / 74.0°
Efficiency 92 %
LEDs/each optic 1
Light colour/type White
Required components:
F15848_HEKLA-SOCKET-G

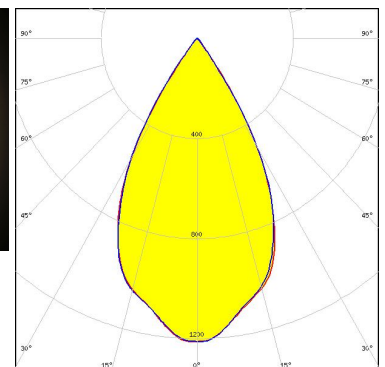
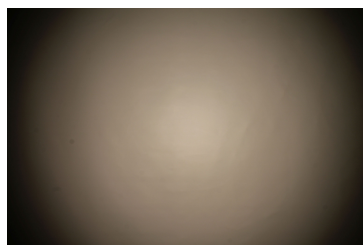

OPTICAL RESULTS (MEASURED):



LED LUXEON CX Plus CoB M02 / M03 (Gen2)
Ordering code C17793_AMY-45-WW
FWHM / FWTM 58.0° / 76.0°
Efficiency 92 %
LEDs/each optic 1
Light colour/type White
Required components:
F15256_HEKLA-SOCKET-D

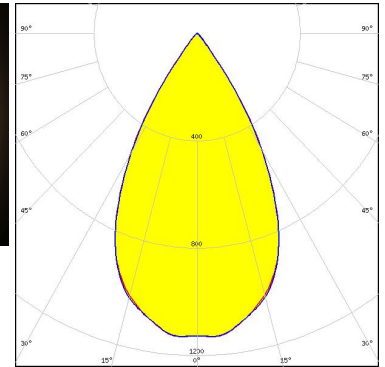
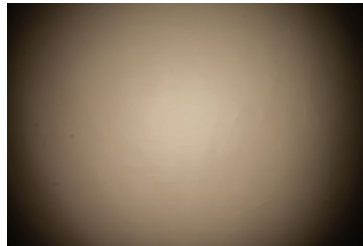

LED LUXEON CX Plus CoB S01 (Gen2)
Ordering code C17793_AMY-45-WW
FWHM / FWTM 59.0° / 75.0°
Efficiency 92 %
LEDs/each optic 1
Light colour/type White
Required components:
F15956_HEKLA-SOCKET-J

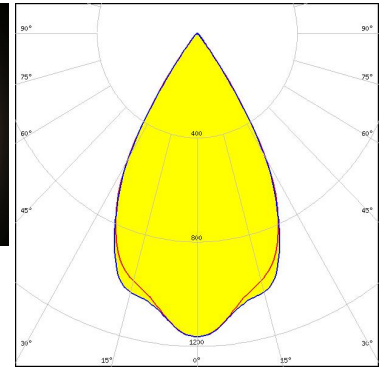

LED CxM-6 (13.5x13.5)
Ordering code C17793_AMY-45-WW
FWHM / FWTM 55.0° / 73.0°
Efficiency 90 %
LEDs/each optic 1
Light colour/type White
Required components:
F17435_HEKLA-G2-C

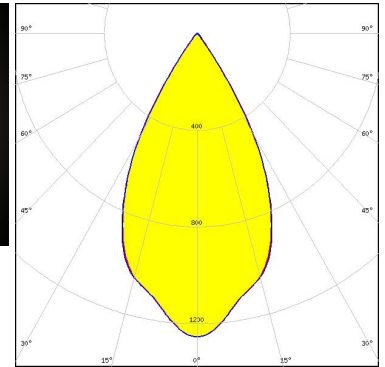
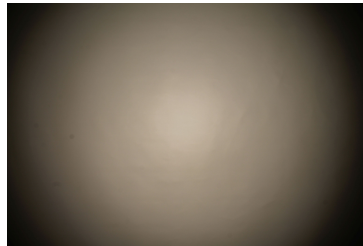

OPTICAL RESULTS (MEASURED):



LED CxM-9 (13.5x13.5)
Ordering code C17793_AMY-45-WW
FWHM / FWTM 54.0° / 76.0°
Efficiency 89 %
LEDs/each optic 1
Light colour/type White
Required components:
F17435_HEKLA-G2-C

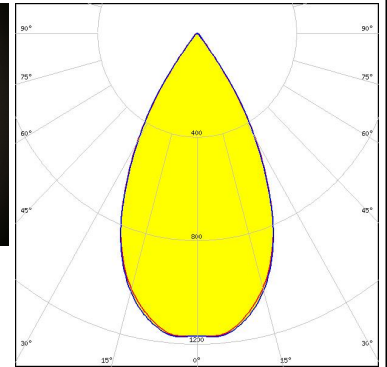
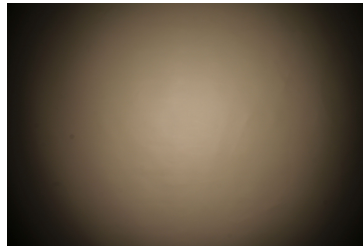

LED COB S-Type (LES 7)
Ordering code C17793_AMY-45-WW
FWHM / FWTM 58.0° / 75.0°
Efficiency 92 %
LEDs/each optic 1
Light colour/type White
Required components:
F15848_HEKLA-SOCKET-G

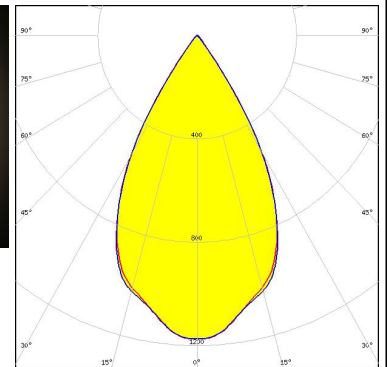
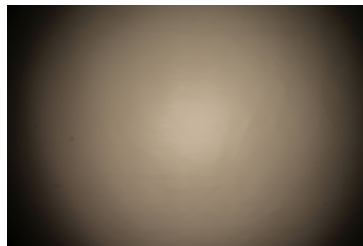

LED COB T-Type
Ordering code C17793_AMY-45-WW
FWHM / FWTM 58.0° / 74.0°
Efficiency 90 %
LEDs/each optic 1
Light colour/type White
Required components:
F15848_HEKLA-SOCKET-G

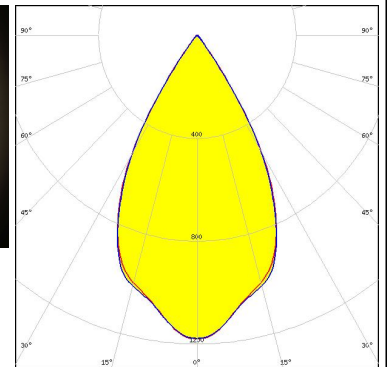
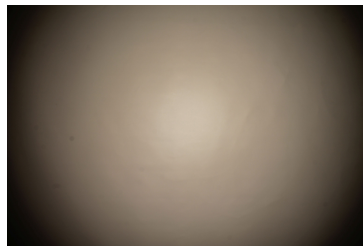

OPTICAL RESULTS (MEASURED):

SAMSUNG

LED LC003D / LC006D / LC009D / LC013D
Ordering code C17793_AMY-45-WW
FWHM / FWTM 56.0° / 78.0°
Efficiency 95 %
LEDs/each optic 1
Light colour/type White
Required components:

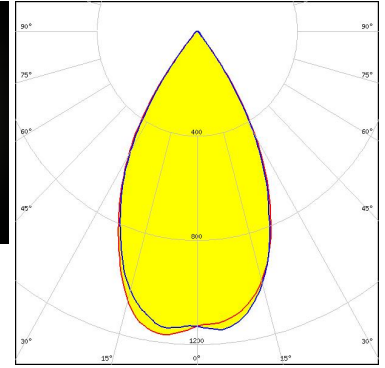

SAMSUNG

LED LC003D / LC006D / LC009D / LC013D
Ordering code C17793_AMY-45-WW
FWHM / FWTM 56.0° / 78.0°
Efficiency 95 %
Peak intensity 1.2 cd/lm
LEDs/each optic 1
Light colour/type White
Required components:
BJB: 47.360.1020

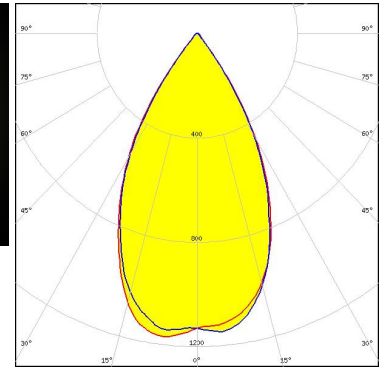
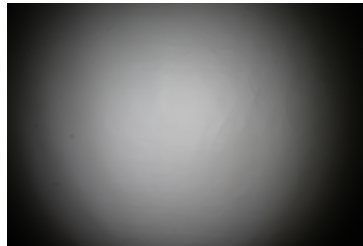

Light distribution files



LED MJT COB LES 6
Ordering code C17793_AMY-45-WW
FWHM / FWTM 56.0° / 73.0°
Efficiency 90 %
LEDs/each optic 1
Light colour/type White
Required components:
F17435_HEKLA-G2-C

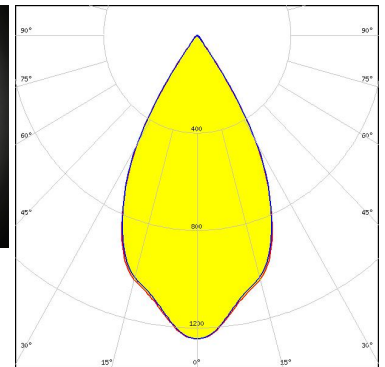

OPTICAL RESULTS (MEASURED):



OPTICAL RESULTS (SIMULATED):

CITIZEN

LED CLL02x/CLU02x (LES10)
Ordering code C17793_AMY-45-WW
FWHM / FWTM 60.0° / 80.0°
Efficiency 93 %
Peak intensity 1.1 cd/lm
LEDs/each optic 1
Light colour/type White
Required components:
F17435_HEKLA-G2-C

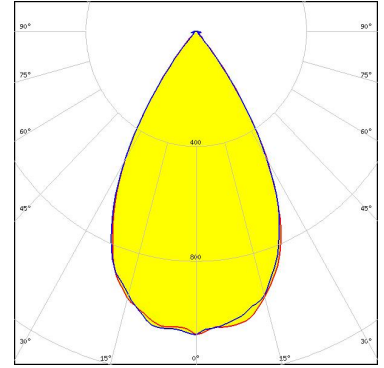

CITIZEN

LED CLU700/701/702/703
Ordering code C17793_AMY-45-WW
FWHM / FWTM 59.0° / 76.0°
Efficiency 93 %
Peak intensity 1.1 cd/lm
LEDs/each optic 1
Light colour/type White
Required components:
F17435_HEKLA-G2-C

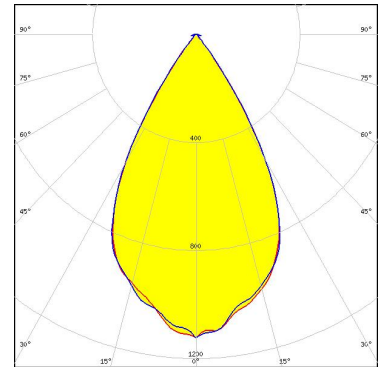



CITIZEN

LED	CLU712/713
Ordering code	C17793_AMY-45-WW
FWHM / FWTM	58.0° / 78.0°
Efficiency	94 %
Peak intensity	1.1 cd/lm
LEDs/each optic	1
Light colour/type	White
Required components:	
	F17438_HEKLA-G2-I

OPTICAL RESULTS (SIMULATED):



LED	CMA1825
Ordering code	C17793_AMY-45-WW
FWHM / FWTM	63.0° / 85.0°
Efficiency	91 %
Peak intensity	1 cd/lm
LEDs/each optic	1
Light colour/type	White
Required components:	
	F15254_HEKLA-SOCKET-B

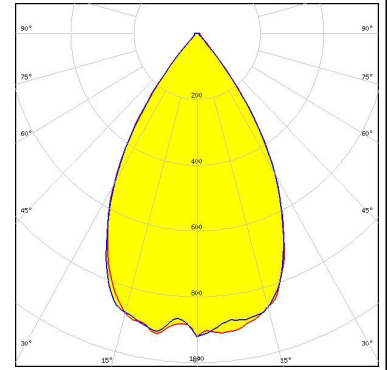

GENERAL INFORMATION:

NOTE: The typical beam angle will be changed by different color, chip size and chip position tolerance. The typical total beam angle is the full angle measured where the luminous intensity is half of the peak value.

Due to use of high power COB's with this product, special attention to proper thermal design is highly recommended. LEDiL has no liability for direct, indirect or consecutive damages arising from the LEDiL products being used outside of the recommended temperature range.

MATERIALS:

As part of our continuous research and improvement processes, and to ensure the best possible quality and availability of our products, LEDiL reserves the right to change material grades without notice.

PRODUCT DATA USER AGREEMENT AND DISCLAIMER:

The measured data in the provided downloadable LEDiL Product Datasheets and Mechanical 2D-Drawings is rounded and provided as reference for planning. LEDiL Oy's optical specifications have been verified by conducting performance testing of the products in accordance with the company's quality system. The reported data are averaged results of multiple measurements with typical variation. LEDiL Oy reserves the right to without prior notification make changes and improvements to its products.

LEDiL Oy assumes neither warranty, nor guarantee nor any other liability of any kind for the contents and correctness of the provided data. The provided data has been generated with highest diligence but the provided data may in reality not represent the complete possible variation range of all intrinsic parameters. Therefore, in certain cases a deviation from the provided data could occur.

LEDiL Oy reserves the right to undertake technical changes of its products without further notification which could lead to changes in the provided data. LEDiL Oy assumes no liability of any kind for the possible deviation from any provided data or any other damage resulting from the usage of the provided data.

The user agrees to this disclaimer and user agreement with the download or usage of the provided files.

LEDiL Oy

Joensuunkatu 13
FI-24240 SALO
Finland

LEDiL Inc.

228 West Page Street
Suite D
Sycamore IL 60178
USA

Ledil Optics Technology (Shenzhen) Co., Ltd.

405 , Block B
Casic Motor Building
Shenzhen 518057
P.R.CHINA

Local sales and technical support

[www.ledil.com/
where_to_buy](http://www.ledil.com/where_to_buy)

Shipping locations

Salo, Finland
Hong Kong, China

Distribution Partners

[www.ledil.com/
where_to_buy](http://www.ledil.com/where_to_buy)