

## BILLIE-A

Asymmetric beam for billboards. Assembly with holder and installation tape.

### SPECIFICATION:

Dimensions	Ø 21.5
Height	16.1 mm
Fastening	tape, pin
ROHS compliant	yes ⓘ



### MATERIALS:

Component	Type	Material	Colour	Finish	Length (mm)
BILLIE-A	Single lens	PMMA	clear		
BILLIE-HLD-PIN-TAPE	Holder	PC	white		
HEIDI-TAPE	Tape	Acryl tape	black		

### ORDERING INFORMATION:

Component	Qty in box	MOQ	MPQ	Box weight (kg)
FCA13329_BILLIE-A » Box size: 480 x 280 x 300 mm	1792	336	112	7.7

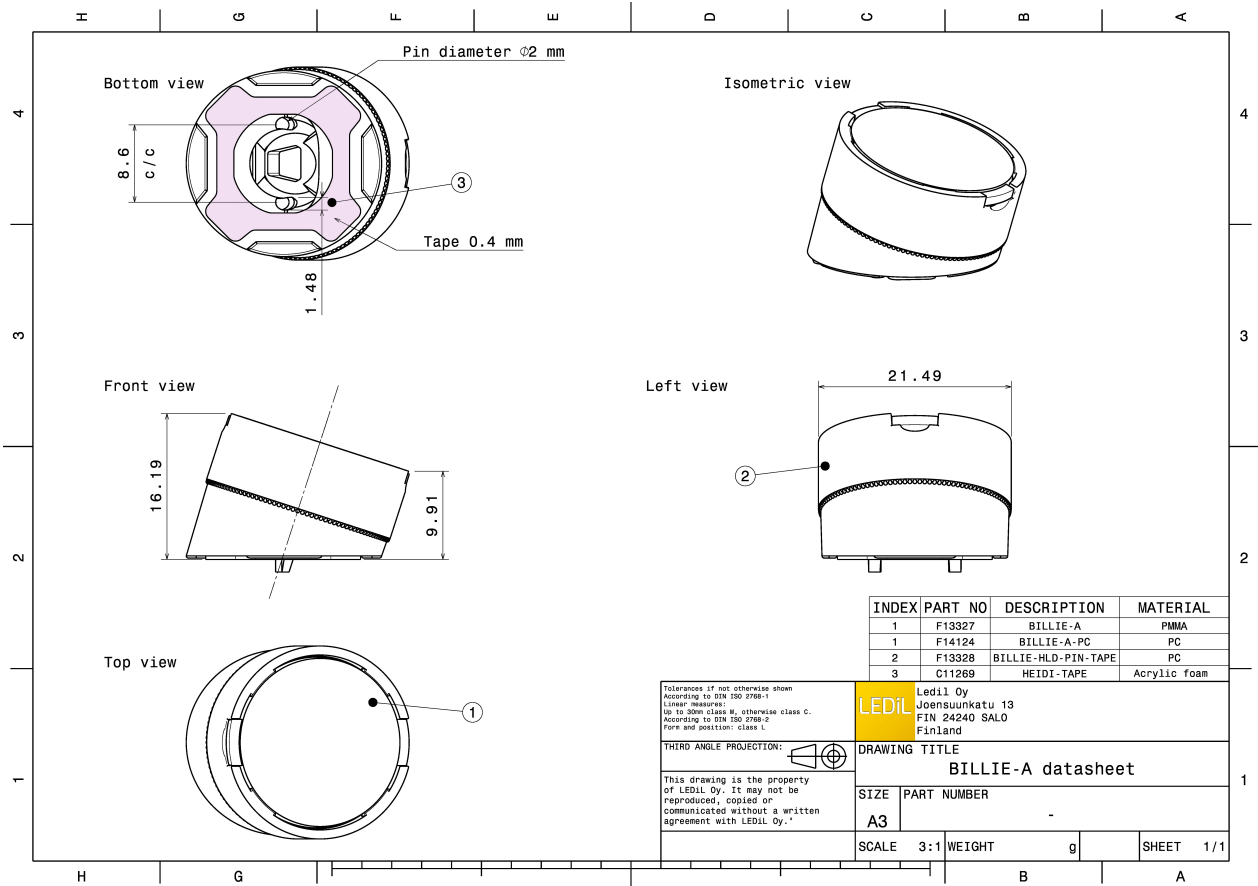

See also our general installation guide: [www.ledil.com/installation\\_guide](http://www.ledil.com/installation_guide)

### OPTICAL RESULTS (MEASURED):



**LED** XB-D  
**FWHM / FWTM** Asymmetric  
**Efficiency** 85 %  
**Peak intensity** 2.1 cd/lm  
**LEDs/each optic** 1  
**Light colour/type** White  
**Required components:**

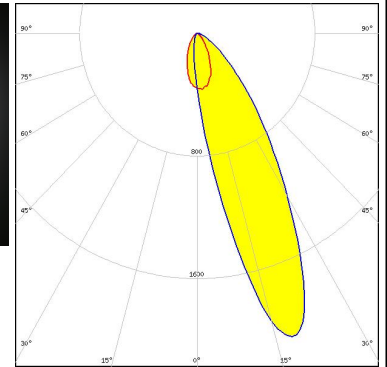

Light distribution files



**LED** XP-E  
**FWHM / FWTM** Asymmetric  
**Efficiency** 89 %  
**Peak intensity** 2.4 cd/lm  
**LEDs/each optic** 1  
**Light colour/type** White  
**Required components:**

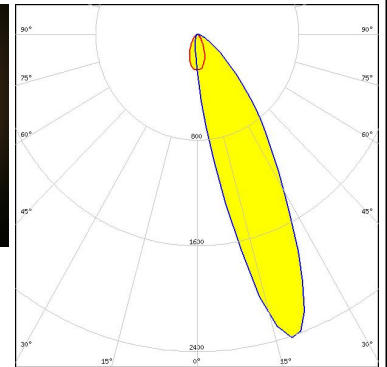

Light distribution files



**LED** XP-G  
**FWHM / FWTM** Asymmetric  
**Efficiency** 88 %  
**Peak intensity** 2.2 cd/lm  
**LEDs/each optic** 1  
**Light colour/type** White  
**Required components:**

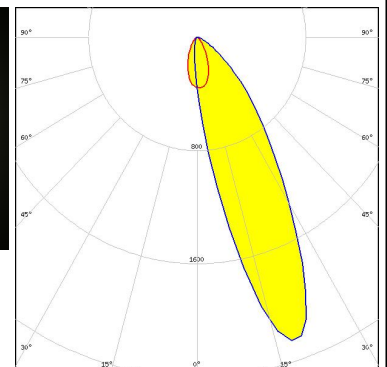
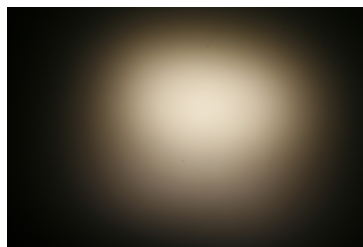

Light distribution files

#### OPTICAL RESULTS (MEASURED):



**LED** LUXEON A  
**FWHM / FWTM** Asymmetric  
**Efficiency** 88 %  
**Peak intensity** 2.1 cd/lm  
**LEDs/each optic** 1  
**Light colour/type** White  
**Required components:**

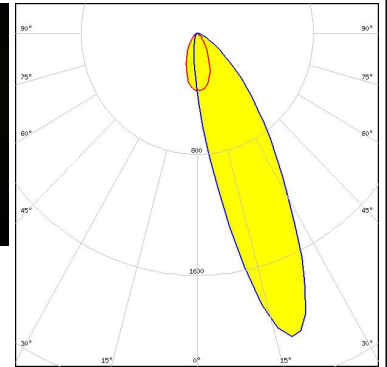

Light distribution files



**LED** LUXEON R  
**FWHM / FWTM** Asymmetric  
**Efficiency** 88 %  
**Peak intensity** 2 cd/lm  
**LEDs/each optic** 1  
**Light colour/type** White  
**Required components:**

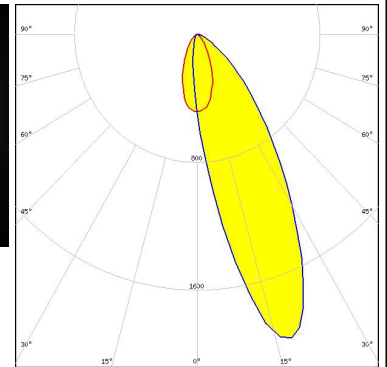

Light distribution files



**LED** LUXEON Rebel  
**FWHM / FWTM** Asymmetric  
**Efficiency** 87 %  
**Peak intensity** 2.2 cd/lm  
**LEDs/each optic** 1  
**Light colour/type** White  
**Required components:**

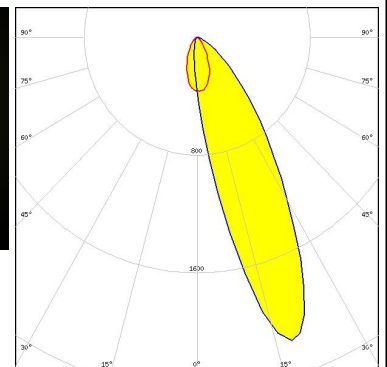
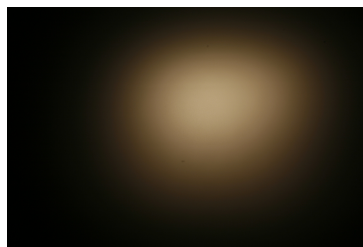

Light distribution files

#### OPTICAL RESULTS (MEASURED):



LED LUXEON Rebel ES  
 FWHM / FWTM Asymmetric  
 Efficiency 88 %  
 Peak intensity 2 cd/lm  
 LEDs/each optic 1  
 Light colour/type White  
 Required components:

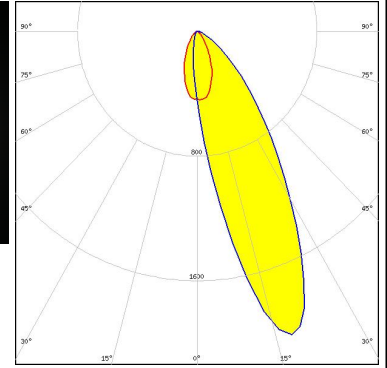

Light distribution files



LED NCSxx19A  
 FWHM / FWTM Asymmetric  
 Efficiency 86 %  
 Peak intensity 2 cd/lm  
 LEDs/each optic 1  
 Light colour/type White  
 Required components:

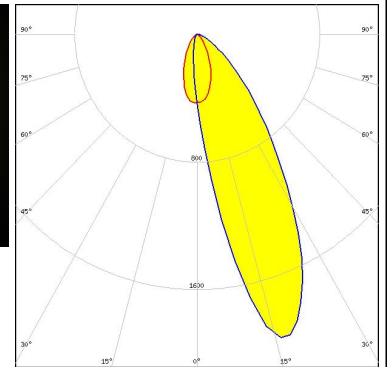
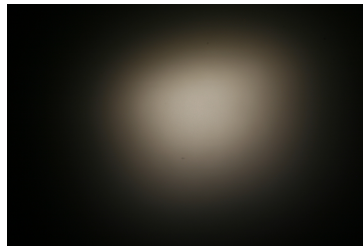

Light distribution files



LED NF2x757A  
 FWHM / FWTM Asymmetric  
 Efficiency 88 %  
 Peak intensity 1.9 cd/lm  
 LEDs/each optic 1  
 Light colour/type White  
 Required components:

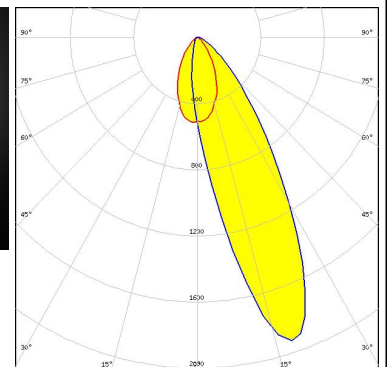
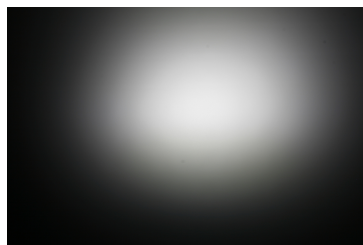

Light distribution files

#### OPTICAL RESULTS (MEASURED):



LED NVSxx19A  
 FWHM / FWTM Asymmetric  
 Efficiency 85 %  
 Peak intensity 1.9 cd/lm  
 LEDs/each optic 1  
 Light colour/type White  
 Required components:

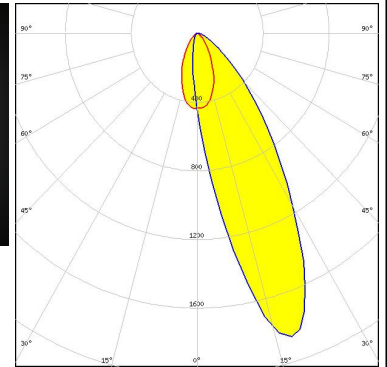

Light distribution files



LED Duris S5 (2 chip)  
 FWHM / FWTM Asymmetric  
 Efficiency 90 %  
 Peak intensity 2 cd/lm  
 LEDs/each optic 1  
 Light colour/type White  
 Required components:

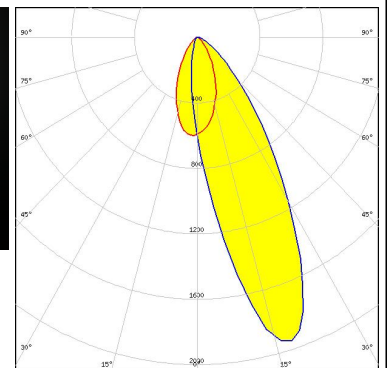
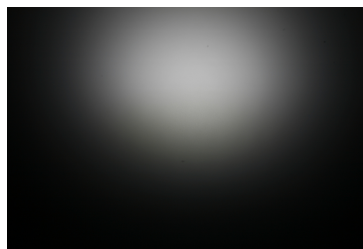

Light distribution files



LED OSLOM SSL 150  
 FWHM / FWTM Asymmetric  
 Efficiency 88 %  
 Peak intensity 2.7 cd/lm  
 LEDs/each optic 1  
 Light colour/type White  
 Required components:

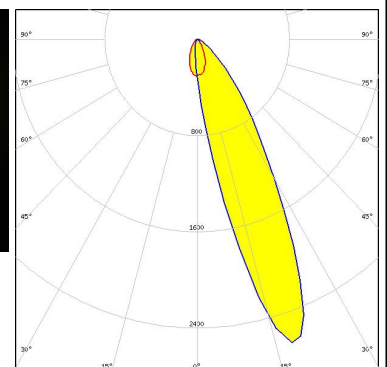
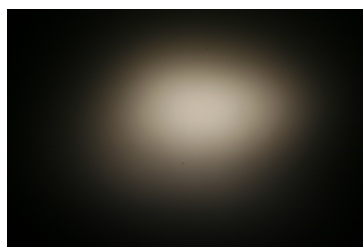

Light distribution files

### OPTICAL RESULTS (MEASURED):

**OSRAM**  
Opto Semiconductors

LED	OSLON SSL 80
FWHM / FWTM	Asymmetric
Efficiency	88 %
Peak intensity	2.1 cd/lm
LEDs/each optic	1
Light colour/type	White
Required components:	

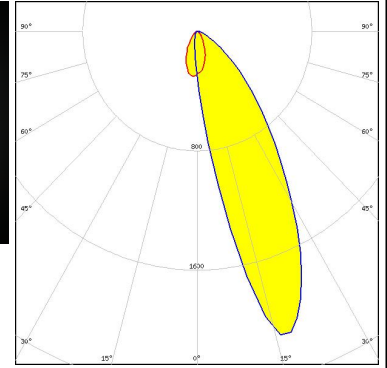

Light distribution files

### OPTICAL RESULTS (SIMULATED):

**LUMILEDS**

LED	LUXEON C
FWHM / FWTM	Asymmetric
Efficiency	90 %
Peak intensity	2.6 cd/lm
LEDs/each optic	1
Light colour/type	White
Required components:	

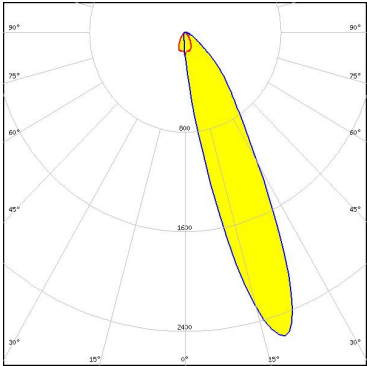

Light distribution files

**NICHIA**

LED	NF2x757G
FWHM / FWTM	Asymmetric
Efficiency	93 %
Peak intensity	2 cd/lm
LEDs/each optic	1
Light colour/type	White
Required components:	

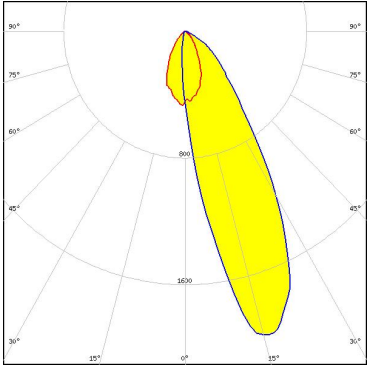

Light distribution files

**OSRAM**  
Opto Semiconductors

LED	OSLON Square EC
FWHM / FWTM	Asymmetric
Efficiency	86 %
Peak intensity	2.3 cd/lm
LEDs/each optic	1
Light colour/type	White
Required components:	

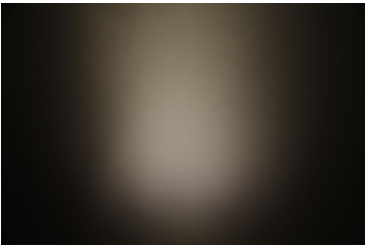
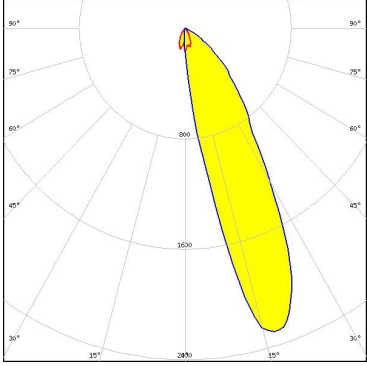
Light distribution files



### GENERAL INFORMATION:

NOTE: The typical beam angle will be changed by different color, chip size and chip position tolerance. The typical total beam angle is the full angle measured where the luminous intensity is half of the peak value.

### MATERIALS:

As part of our continuous research and improvement processes, and to ensure the best possible quality and availability of our products, LEDiL reserves the right to change material grades without notice.

### PRODUCT DATA USER AGREEMENT AND DISCLAIMER:

The measured data in the provided downloadable LEDiL Product Datasheets and Mechanical 2D-Drawings is rounded and provided as reference for planning. LEDiL Oy's optical specifications have been verified by conducting performance testing of the products in accordance with the company's quality system. The reported data are averaged results of multiple measurements with typical variation. LEDiL Oy reserves the right to without prior notification make changes and improvements to its products.

LEDiL Oy assumes neither warranty, nor guarantee nor any other liability of any kind for the contents and correctness of the provided data. The provided data has been generated with highest diligence but the provided data may in reality not represent the complete possible variation range of all intrinsic parameters. Therefore, in certain cases a deviation from the provided data could occur.

LEDiL Oy reserves the right to undertake technical changes of its products without further notification which could lead to changes in the provided data. LEDiL Oy assumes no liability of any kind for the possible deviation from any provided data or any other damage resulting from the usage of the provided data.

The user agrees to this disclaimer and user agreement with the download or usage of the provided files.

#### LEDiL Oy

Joensuunkatu 7  
FI-24100 SALO  
Finland

#### LEDiL Inc.

228 West Page Street  
Suite D  
Sycamore IL 60178  
USA

#### Ledil Optics Technology (Shenzhen) Co., Ltd.

# 405 , Block B  
Casic Motor Building  
Shenzhen 518057  
P.R.CHINA

#### Local sales and technical support

[www.ledil.com/  
where\\_to\\_buy](http://www.ledil.com/where_to_buy)

#### Shipping locations

Poznan, Poland  
Hong Kong, China

#### Distribution Partners

[www.ledil.com/  
where\\_to\\_buy](http://www.ledil.com/where_to_buy)