

CARMEN-RS-C

~10° spot beam. Assembly with holder C compatible with LEDiL HEKLA.

SPECIFICATION:

Dimensions	Ø 69.5 mm
Height	41.5 mm
Fastening	socket
ROHS compliant	yes ⓘ



MATERIALS:

Component	Type	Material	Colour	Finish	Length
CARMEN-RS	Single lens	PMMA	clear		66.4
CARMEN-HLD-C	Holder	PC	black		69.5

ORDERING INFORMATION:

Component	Type	Qty in box	MOQ	MPQ	Box weight (kg)
CP15916_CARMEN-RS-C	Single lens	150	150	15	6.2
» Box size: 480 x 280 x 300 mm					

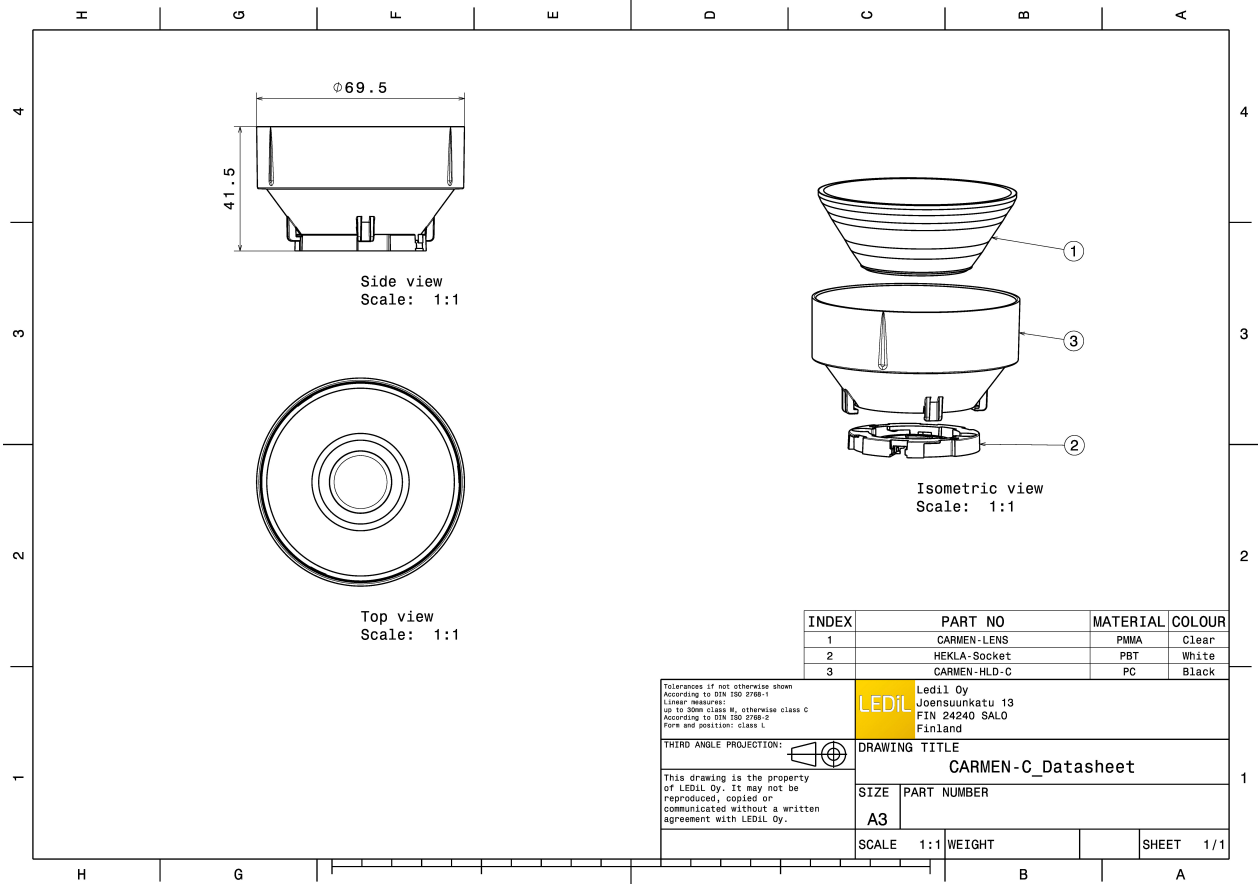

See also our general installation guide: www.ledil.com/installation_guide

OPTICAL RESULTS (MEASURED):

bridgelux

LED V4 HD Gen 7
 FWHM / FWTM 7.0° / 12.0°
 Efficiency 68 %
 Peak intensity 31 cd/lm
 LEDs/each optic 1
 Light colour/type White
 Required components:
 F15253_HEKLA-SOCKET-A

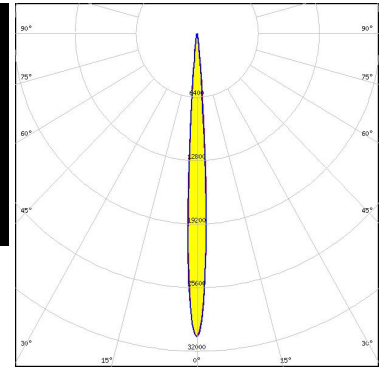
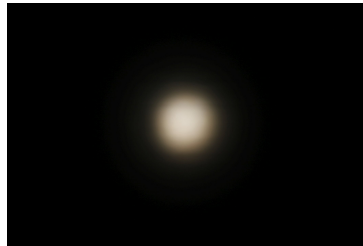

Light distribution files

bridgelux

LED V6 HD Gen 7
 FWHM / FWTM 9.6° / 15.0°
 Efficiency 65 %
 Peak intensity 16.9 cd/lm
 LEDs/each optic 1
 Light colour/type White
 Required components:
 F15255_HEKLA-SOCKET-C

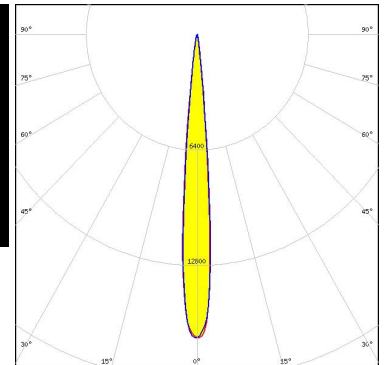

Light distribution files

bridgelux

LED V9 HD Gen7
 FWHM / FWTM 13.0° / 20.0°
 Efficiency 63 %
 Peak intensity 10.6 cd/lm
 LEDs/each optic 1
 Light colour/type White
 Required components:
 F15859_HEKLA-SOCKET-I

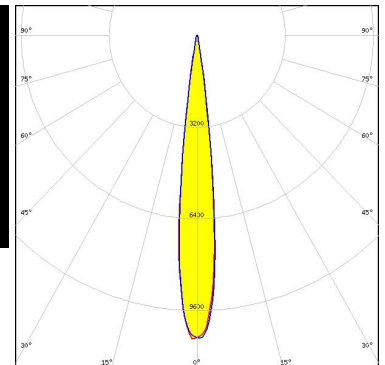
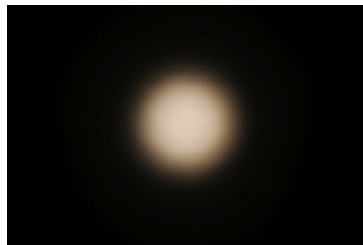

Light distribution files

OPTICAL RESULTS (MEASURED):



LED VERO10
FWHM / FWTM 12.0° / 21.0°
Efficiency 61 %
Peak intensity 9.9 cd/lm
LEDs/each optic 1
Light colour/type White
Required components:
 F15616_HEKLA-SOCKET-F

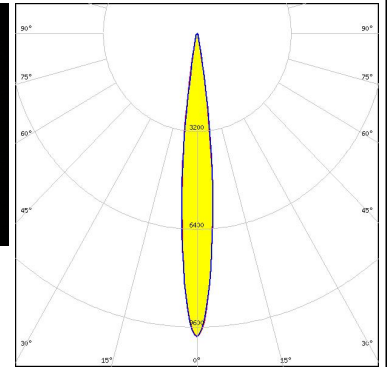

Light distribution files



LED Vesta TW 6mm DP
FWHM / FWTM 9.0° / 16.0°
Efficiency 59 %
Peak intensity 16.5 cd/lm
LEDs/each optic 1
Light colour/type White
Required components:
 C16142_HEKLA-SOCKET-K
 Bender Wirth: 504 Typ L8

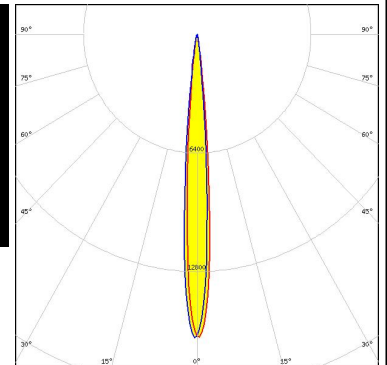

Light distribution files



LED Vesta TW 9mm (9W) DP
FWHM / FWTM 12.0° / 23.0°
Efficiency 56 %
Peak intensity 7.8 cd/lm
LEDs/each optic 1
Light colour/type White
Required components:
 C16142_HEKLA-SOCKET-K
 Bender Wirth: 489 Typ L8

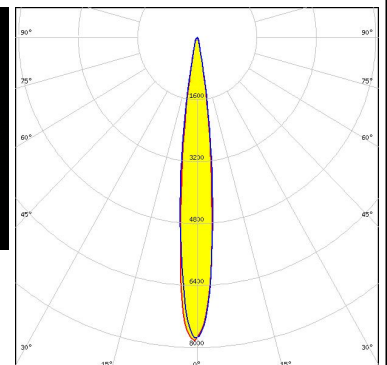

Light distribution files

OPTICAL RESULTS (MEASURED):

CITIZEN

LED CLL02x/CLU02x (LES10)
FWHM / FWTM 13.0° / 22.0°
Efficiency 59 %
Peak intensity 8.6 cd/lm
LEDs/each optic 1
Light colour/type White
Required components:
F15255_HEKLA-SOCKET-C

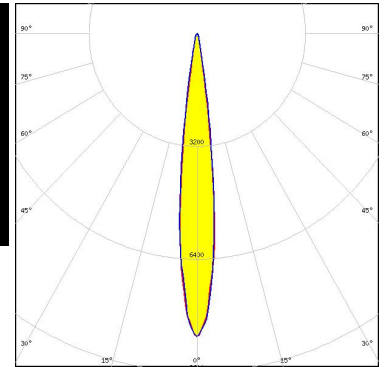
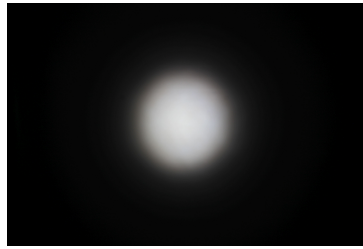

Light distribution files

CITIZEN

LED CLU700/701/702/703
FWHM / FWTM 9.0° / 15.0°
Efficiency 69 %
Peak intensity 22.6 cd/lm
LEDs/each optic 1
Light colour/type White
Required components:
F15255_HEKLA-SOCKET-C

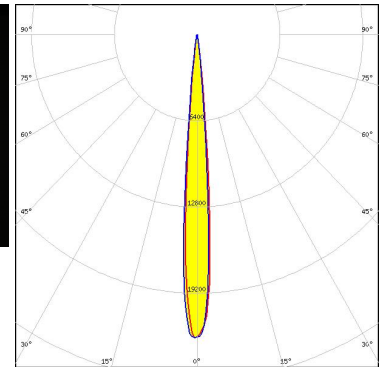

Light distribution files

CITIZEN

LED CLU700/701/702/703
FWHM / FWTM 8.0° / 15.0°
Efficiency 62 %
Peak intensity 20.2 cd/lm
LEDs/each optic 1
Light colour/type White
Required components:
F15255_HEKLA-SOCKET-C

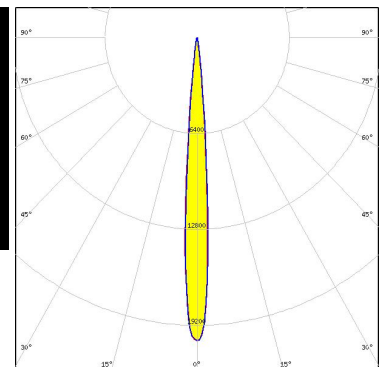
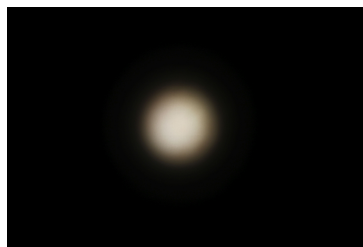

Light distribution files

OPTICAL RESULTS (MEASURED):

CITIZEN

LED CLU710/711
FWHM / FWTM 12.0° / 19.0°
Efficiency 64 %
Peak intensity 11.5 cd/lm
LEDs/each optic 1
Light colour/type White
Required components:
F15859_HEKLA-SOCKET-I

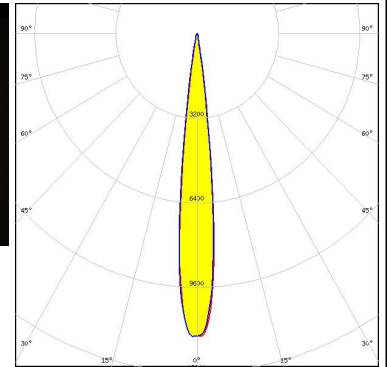

Light distribution files

CITIZEN

LED CLU7A2/7A3
FWHM / FWTM 6.0° / 11.0°
Efficiency 65 %
Peak intensity 34.7 cd/lm
LEDs/each optic 1
Light colour/type White
Required components:
F15255_HEKLA-SOCKET-C

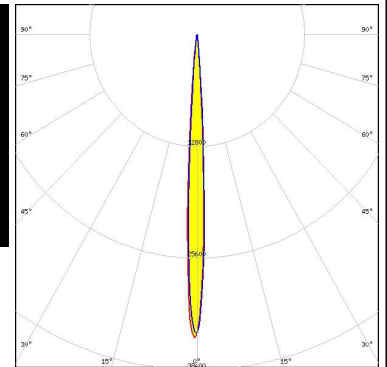
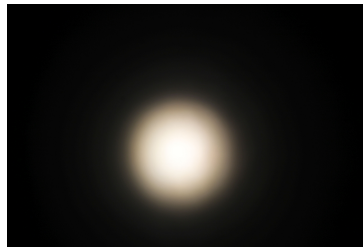

Light distribution files

CITIZEN

LED CLU7B2
FWHM / FWTM 6.0° / 10.0°
Efficiency 66 %
Peak intensity 43.4 cd/lm
LEDs/each optic 1
Light colour/type White
Required components:
F15255_HEKLA-SOCKET-C

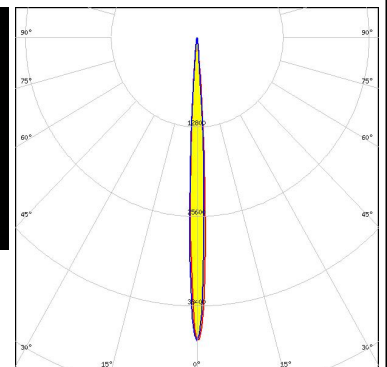

Light distribution files

OPTICAL RESULTS (MEASURED):



LED CMA1516
 FWHM / FWTM 13.0° / 20.0°
 Efficiency 63 %
 Peak intensity 9.7 cd/lm
 LEDs/each optic 1
 Light colour/type White
 Required components:
 F15256_HEKLA-SOCKET-D

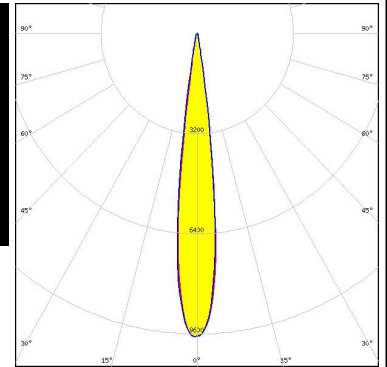

Light distribution files



LED CMT14xx
 FWHM / FWTM 14.0° / 23.0°
 Efficiency 40 %
 Peak intensity 5 cd/lm
 LEDs/each optic 1
 Light colour/type White
 Required components:
 F15255_HEKLA-SOCKET-C

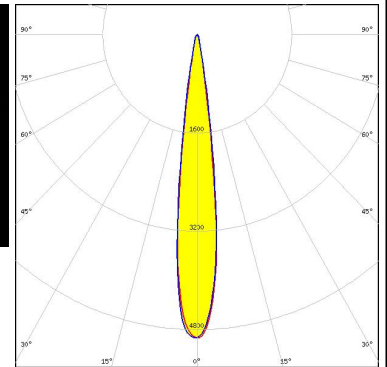

Light distribution files



LED CXA/B 13xx
 FWHM / FWTM 8.0° / 15.0°
 Efficiency 64 %
 Peak intensity 21.4 cd/lm
 LEDs/each optic 1
 Light colour/type White
 Required components:
 F15956_HEKLA-SOCKET-J

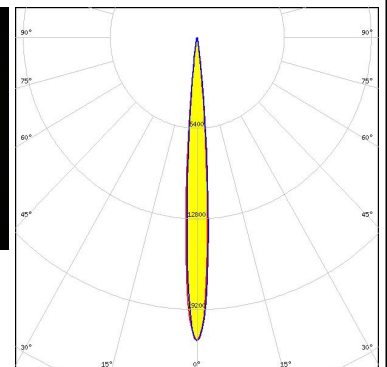

Light distribution files

OPTICAL RESULTS (MEASURED):



LED CXA/B 15xx
 FWHM / FWTM 13.0° / 20.0°
 Efficiency 65 %
 Peak intensity 11.3 cd/lm
 LEDs/each optic 1
 Light colour/type White
 Required components:
 F15256_HEKLA-SOCKET-D

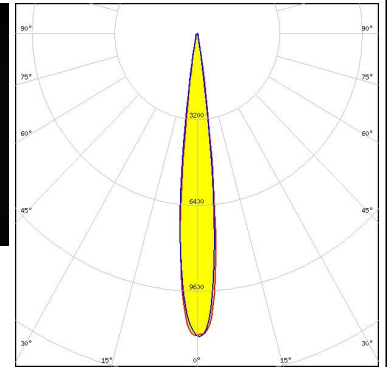

Light distribution files



LED CXA/B 1816 & CXA/B 1820 & CXA 1850
 FWHM / FWTM 17.0° / 26.0°
 Efficiency 59 %
 Peak intensity 5.6 cd/lm
 LEDs/each optic 1
 Light colour/type White
 Required components:
 F15256_HEKLA-SOCKET-D

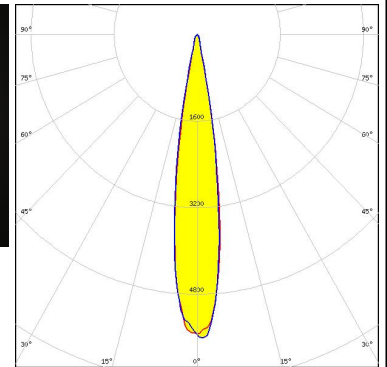

Light distribution files



LED LUXEON CX Plus CoB L08 (Gen2)
 FWHM / FWTM 17.0° / 30.0°
 Efficiency 54 %
 Peak intensity 4.3 cd/lm
 LEDs/each optic 1
 Light colour/type White
 Required components:
 Bender Wirth: 637a Hekla

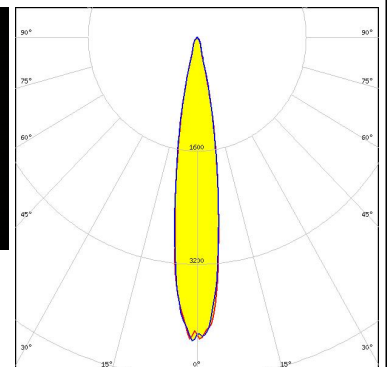
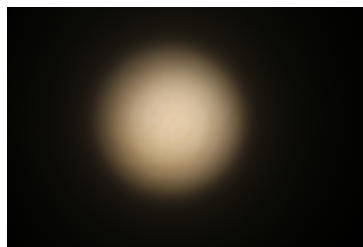

Light distribution files

OPTICAL RESULTS (MEASURED):



LED LUXEON CoB 1202HD
FWHM / FWTM 9.7° / 15.0°
Efficiency 66 %
Peak intensity 18.5 cd/lm
LEDs/each optic 1
Light colour/type White
Required components:
 F15848_HEKLA-SOCKET-G

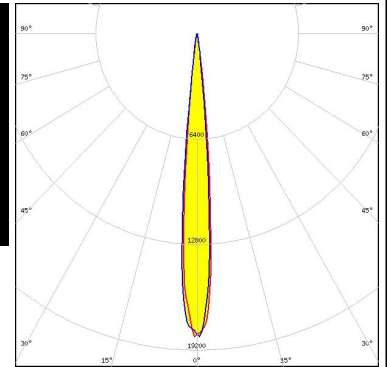

Light distribution files



LED LUXEON CoB 1204HD
FWHM / FWTM 13.0° / 20.0°
Efficiency 63 %
Peak intensity 10 cd/lm
LEDs/each optic 1
Light colour/type White
Required components:
 F15858_HEKLA-SOCKET-H

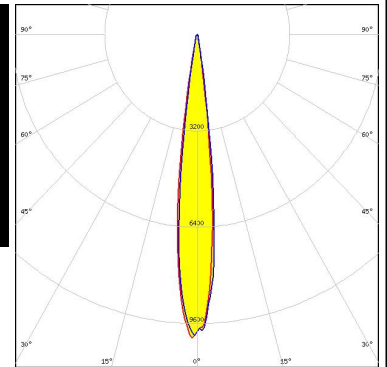
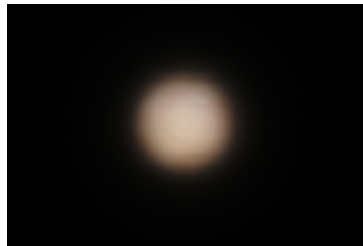

Light distribution files



LED LUXEON CoB 1205HD
FWHM / FWTM 15.0° / 25.0°
Efficiency 59 %
Peak intensity 6.4 cd/lm
LEDs/each optic 1
Light colour/type White
Required components:
 F15858_HEKLA-SOCKET-H

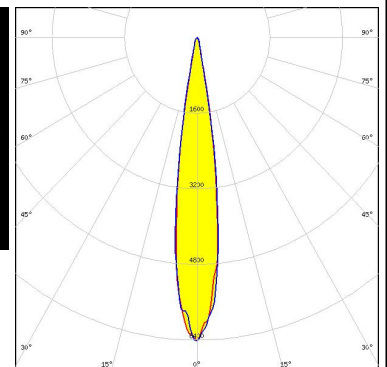
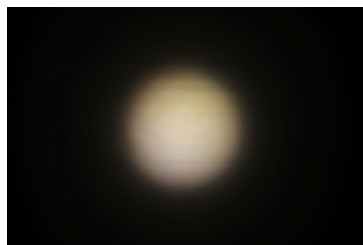

Light distribution files

OPTICAL RESULTS (MEASURED):



LED LUXEON CX Plus CoB - HD S01H4
 FWHM / FWTM 8.0° / 14.0°
 Efficiency 67 %
 Peak intensity 27.5 cd/lm
 LEDs/each optic 1
 Light colour/type White
 Required components:
 Bender Wirth: 634c Hekla

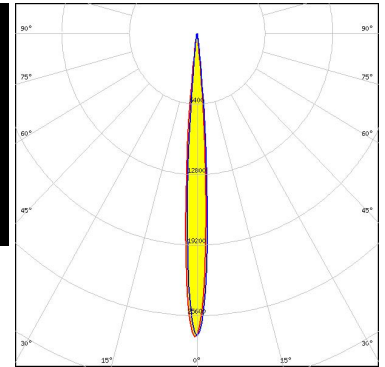
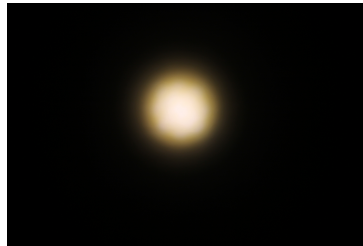

Light distribution files



LED LUXEON CX Plus CoB - HD S04H9
 FWHM / FWTM 13.0° / 20.0°
 Efficiency 61 %
 Peak intensity 10.3 cd/lm
 LEDs/each optic 1
 Light colour/type White
 Required components:
 Bender Wirth: 634c Hekla

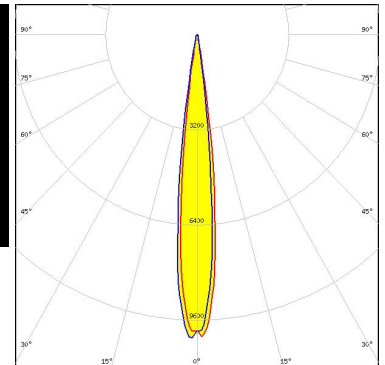

Light distribution files



LED LUXEON CX Plus CoB L04 / L05 (Gen2)
 FWHM / FWTM 15.0° / 26.0°
 Efficiency 58 %
 Peak intensity 6.5 cd/lm
 LEDs/each optic 1
 Light colour/type White
 Required components:
 Bender Wirth: 637a Hekla

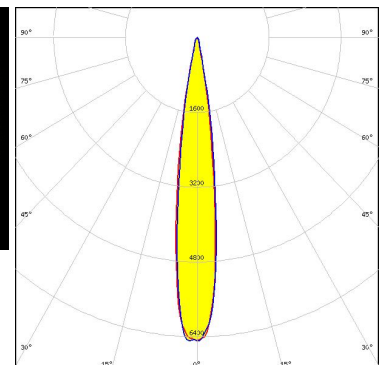

Light distribution files

OPTICAL RESULTS (MEASURED):



LED LUXEON CX Plus CoB M02 / M03 (Gen2)
FWHM / FWTM 11.0° / 20.0°
Efficiency 62 %
Peak intensity 12.8 cd/lm
LEDs/each optic 1
Light colour/type White
Required components:
 Bender Wirth: 641a Hekla

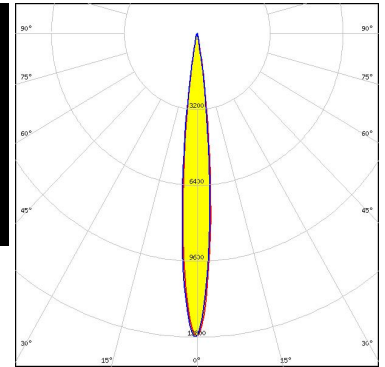
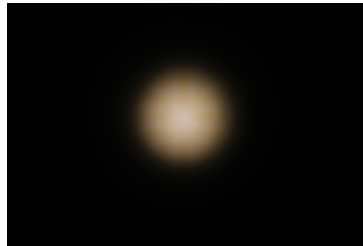

Light distribution files



LED LUXEON CX Plus CoB S01 (Gen2)
FWHM / FWTM 8.0° / 14.0°
Efficiency 66 %
Peak intensity 27.5 cd/lm
LEDs/each optic 1
Light colour/type White
Required components:
 Bender Wirth: 634c Hekla

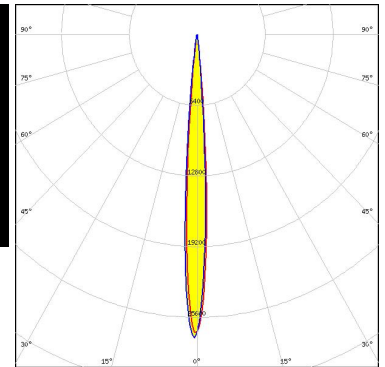
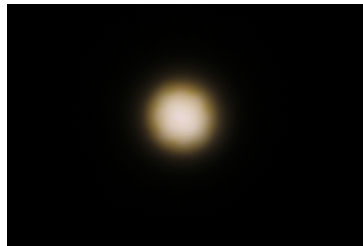

Light distribution files



LED CxM-11 (19x19)
FWHM / FWTM 15.0° / 26.0°
Efficiency 56 %
Peak intensity 5.5 cd/lm
LEDs/each optic 1
Light colour/type White
Required components:
 F15859_HEKLA-SOCKET-I

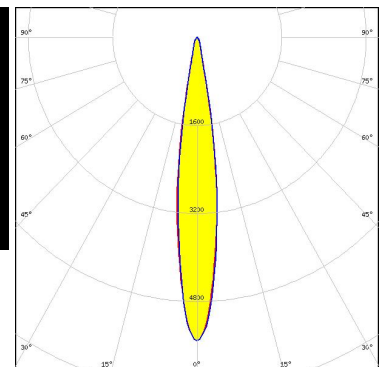

Light distribution files

OPTICAL RESULTS (MEASURED):

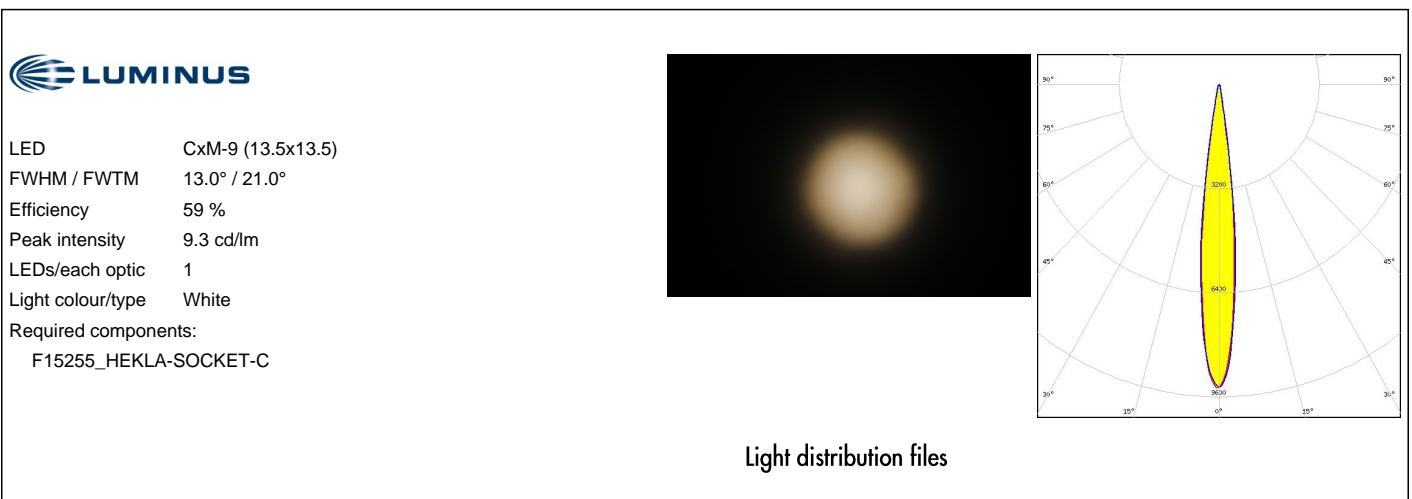
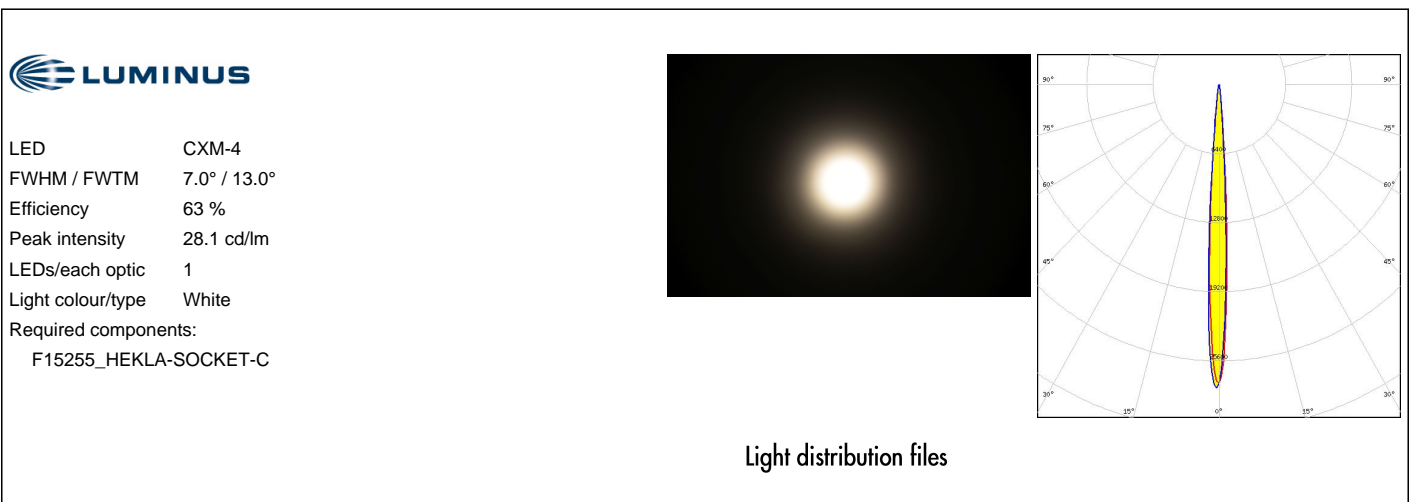
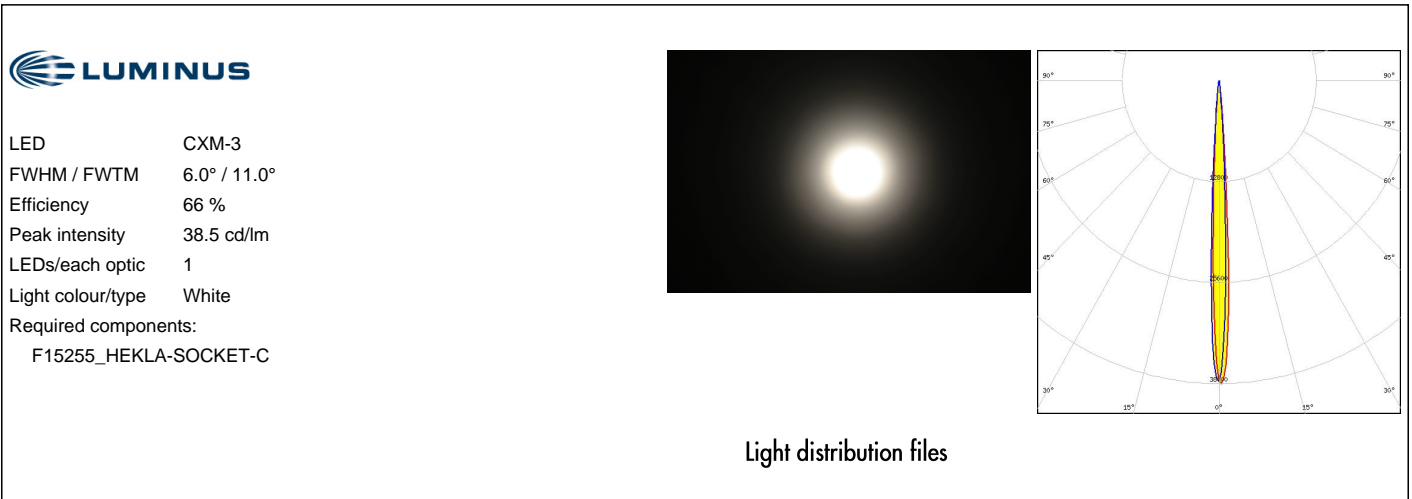

OPTICAL RESULTS (MEASURED):

PHILIPS

LED Fortimo SLM L09 CoB
FWHM / FWTM 13.0° / 21.0°
Efficiency 63 %
Peak intensity 9.6 cd/lm
LEDs/each optic 1
Light colour/type White
Required components:
F15858_HEKLA-SOCKET-H

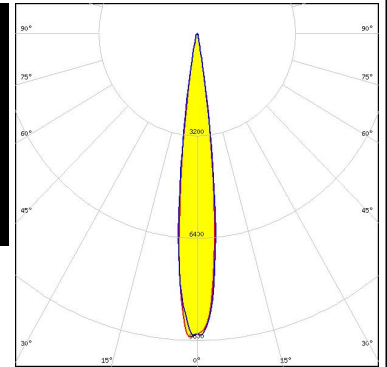
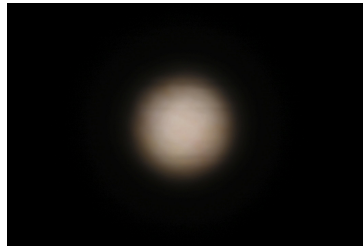

Light distribution files

SAMSUNG

LED LC003D / LC006D / LC009D / LC013D
FWHM / FWTM 13.0° / 21.0°
Efficiency 60 %
Peak intensity 9.3 cd/lm
LEDs/each optic 1
Light colour/type White
Required components:
F15255_HEKLA-SOCKET-C

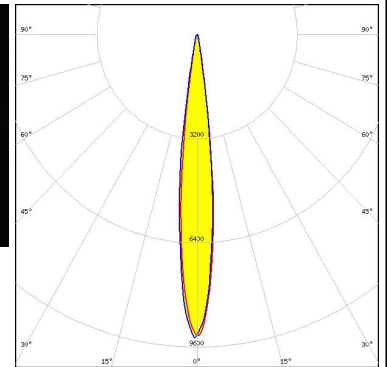
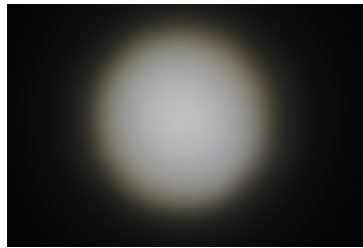

Light distribution files

SAMSUNG

LED LC020C
FWHM / FWTM 11.0° / 19.0°
Efficiency 61 %
Peak intensity 12 cd/lm
LEDs/each optic 1
Light colour/type White
Required components:
F15848_HEKLA-SOCKET-G

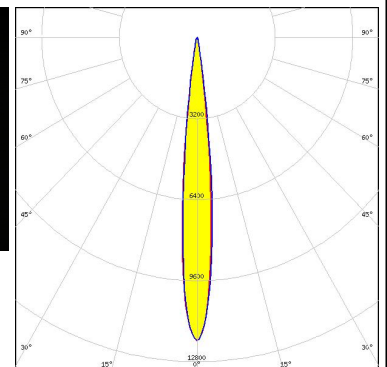
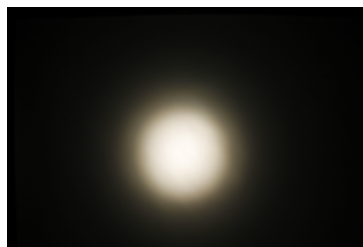

Light distribution files

OPTICAL RESULTS (MEASURED):

SAMSUNG

LED LC020C G2
FWHM / FWTM 12.0° / 20.0°
Efficiency 59 %
Peak intensity 10 cd/lm
LEDs/each optic 1
Light colour/type White
Required components:
F15859_HEKLA-SOCKET-I

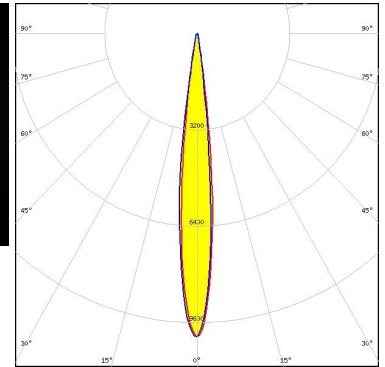

Light distribution files

TRIDONIC

LED SLE G7 LES09
FWHM / FWTM 12.0° / 19.0°
Efficiency 61 %
Peak intensity 10.9 cd/lm
LEDs/each optic 1
Light colour/type White
Required components:
F15255_HEKLA-SOCKET-C

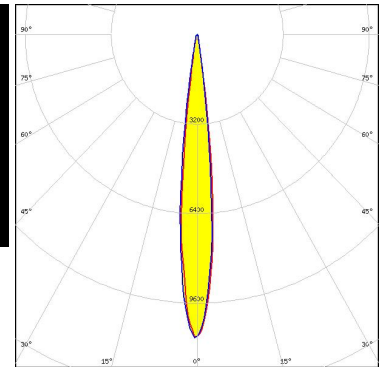
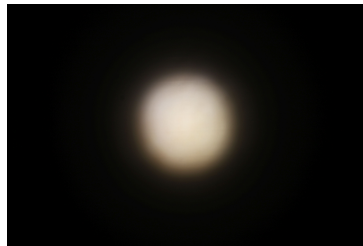

Light distribution files

TRIDONIC

LED SLE G7 LES13
FWHM / FWTM 17.0° / 28.0°
Efficiency 56 %
Peak intensity 5 cd/lm
LEDs/each optic 1
Light colour/type White
Required components:
F15859_HEKLA-SOCKET-I

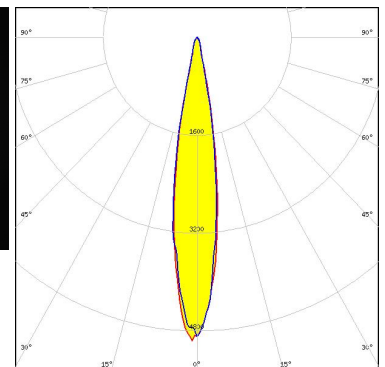

Light distribution files

OPTICAL RESULTS (MEASURED):

XICATO

LED XOB 6 mm
 FWHM / FWTM 9.0° / 15.0°
 Efficiency 62 %
 Peak intensity 20.1 cd/lm
 LEDs/each optic 1
 Light colour/type White
 Required components:
 F15255_HEKLA-SOCKET-C

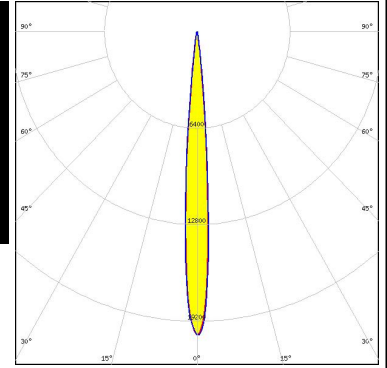
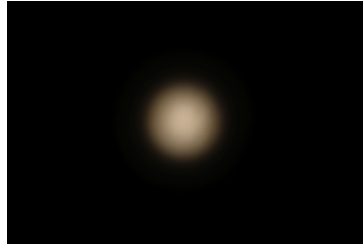

Light distribution files

XICATO

LED XOB 9.8 mm
 FWHM / FWTM 12.0° / 20.0 + 20.5°
 Efficiency 60 %
 Peak intensity 10.4 cd/lm
 LEDs/each optic 1
 Light colour/type White
 Required components:
 F15255_HEKLA-SOCKET-C

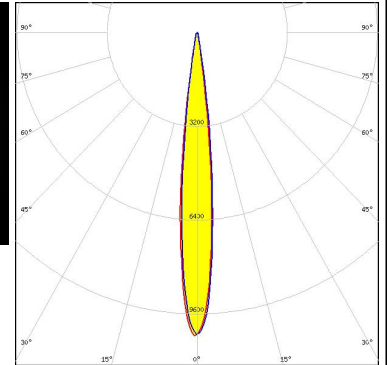
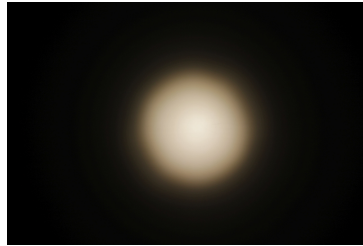

Light distribution files

XICATO

LED XTM - 19mm LES
 FWHM / FWTM 18.0° / 38.0°
 Efficiency 50 %
 Peak intensity 2.9 cd/lm
 LEDs/each optic 1
 Light colour/type White
 Required components:
 C16058_XTM-ADAPTER-50-C

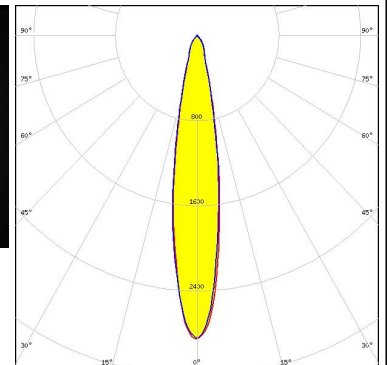

Light distribution files

OPTICAL RESULTS (SIMULATED):



LED VERO13
FWHM / FWTM 15.0° / 30.0°
Efficiency 61 %
Peak intensity 5.3 cd/lm
LEDs/each optic 1
Light colour/type White
Required components:
 C16142_HEKLA-SOCKET-K

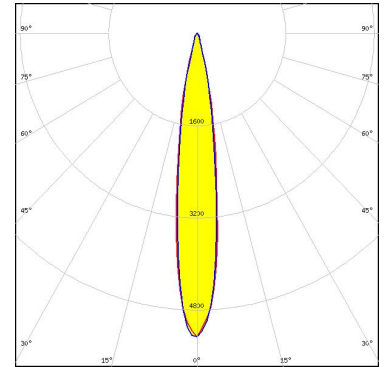

Light distribution files

CITIZEN

LED CLL02x/CLU02x (LES10)
FWHM / FWTM 14.0° / 24.0°
Efficiency 45 %
Peak intensity 7.3 cd/lm
LEDs/each optic 1
Light colour/type White
Required components:
 F15859_HEKLA-SOCKET-I
 C16752_CARMEN-70-SHD

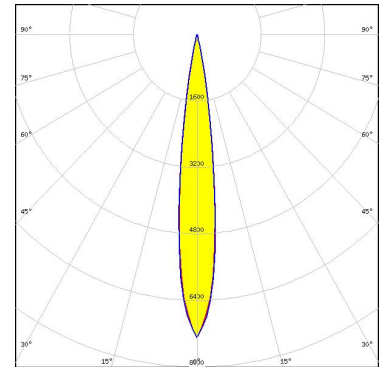

Light distribution files

CITIZEN

LED CLU700/701/702/703
FWHM / FWTM 9.0° / 16.0°
Efficiency 51 %
Peak intensity 17.5 cd/lm
LEDs/each optic 1
Light colour/type White
Required components:
 F15255_HEKLA-SOCKET-C
 C16752_CARMEN-70-SHD

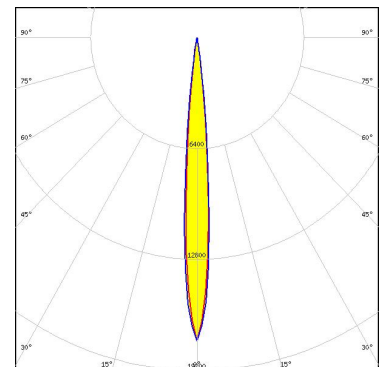

Light distribution files

OPTICAL RESULTS (SIMULATED):

CITIZEN

LED CLU712/713
FWHM / FWTM 13.0° / 22.0°
Efficiency 47 %
Peak intensity 8.7 cd/lm
LEDs/each optic 1
Light colour/type White

Required components:

F15859_HEKLA-SOCKET-I
C16752_CARMEN-70-SHD

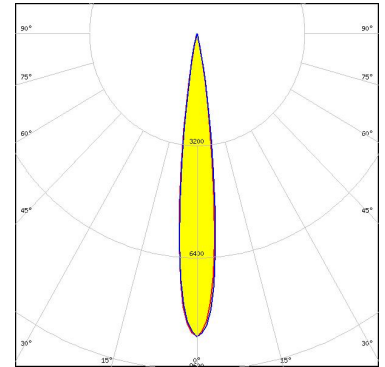

Light distribution files

CITIZEN

LED CLU712/713
FWHM / FWTM 12.0° / 22.0°
Efficiency 64 %
Peak intensity 10.8 cd/lm
LEDs/each optic 1
Light colour/type White

Required components:

F15859_HEKLA-SOCKET-I

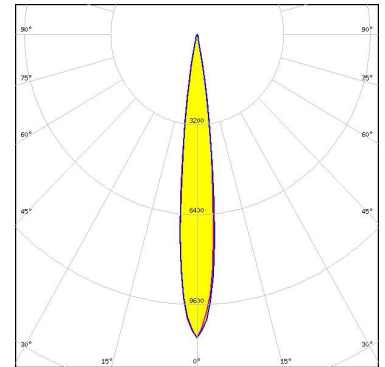

Light distribution files

CITIZEN

LED CLU720/721/723
FWHM / FWTM 15.0° / 29.0°
Efficiency 61 %
Peak intensity 6.6 cd/lm
LEDs/each optic 1
Light colour/type White

Required components:

F15859_HEKLA-SOCKET-I

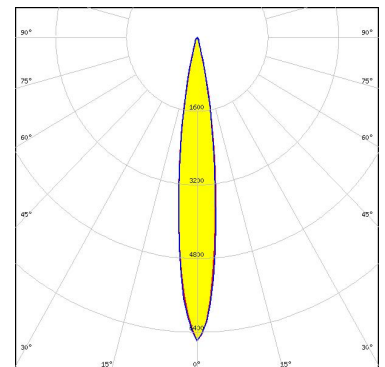

Light distribution files

OPTICAL RESULTS (SIMULATED):

CITIZEN

LED CLU7A2/7A3
 FWHM / FWTM 8.0° / 14.0°
 Efficiency 52 %
 Peak intensity 25.9 cd/lm
 LEDs/each optic 1
 Light colour/type White

Required components:

F15255_HEKLA-SOCKET-C
 C16752_CARMEN-70-SHD

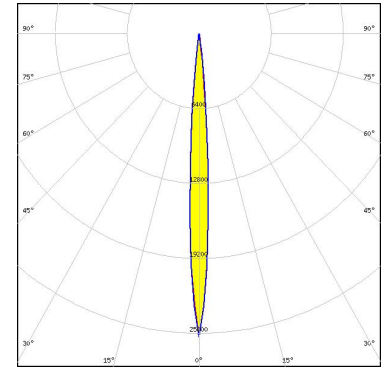

Light distribution files

LUMILEDS

LED LUXEON CoB Compact
 FWHM / FWTM 10.0° / 18.0°
 Efficiency 71 %
 Peak intensity 18 cd/lm
 LEDs/each optic 1
 Light colour/type White

Required components:

F15848_HEKLA-SOCKET-G

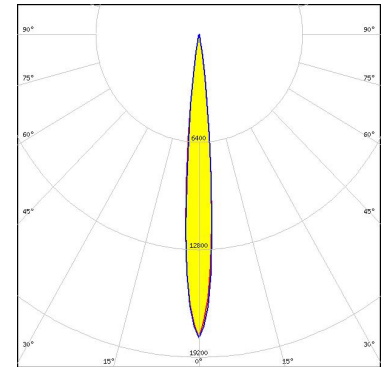

Light distribution files

LUMINUS

LED CXM-4
 FWHM / FWTM 8.0° / 14.0°
 Efficiency 52 %
 Peak intensity 24.6 cd/lm
 LEDs/each optic 1
 Light colour/type White

Required components:

F17435_HEKLA-G2-C
 C16752_CARMEN-70-SHD

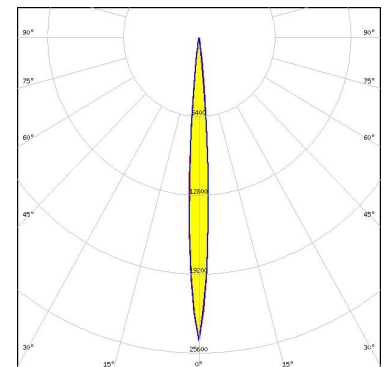

Light distribution files

OPTICAL RESULTS (SIMULATED):



LED CxM-6 (12x13)
 FWHM / FWTM 10.0° / 18.0°
 Efficiency 68 %
 Peak intensity 18.5 cd/lm
 LEDs/each optic 1
 Light colour/type White
 Required components:
 F15255_HEKLA-SOCKET-C

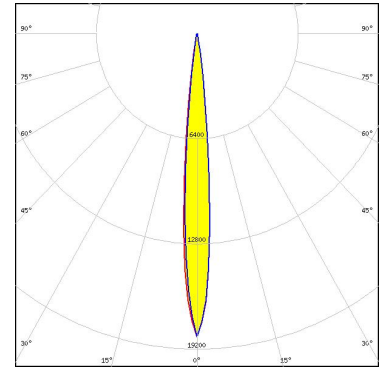

Light distribution files



LED CxM-6 (13.5x13.5)
 FWHM / FWTM 10.0° / 18.0°
 Efficiency 68 %
 Peak intensity 18.5 cd/lm
 LEDs/each optic 1
 Light colour/type White
 Required components:
 F17435_HEKLA-G2-C

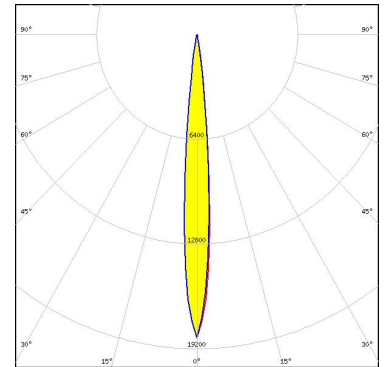

Light distribution files



LED LC003D / LC006D / LC009D / LC013D
 FWHM / FWTM 13.0° / 24.0°
 Efficiency 62 %
 Peak intensity 8.7 cd/lm
 LEDs/each optic 1
 Light colour/type White
 Required components:
 F17435_HEKLA-G2-C

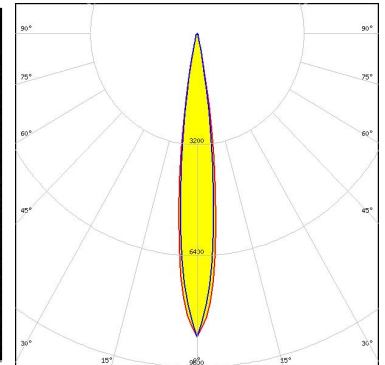

Light distribution files

OPTICAL RESULTS (SIMULATED):

SAMSUNG

LED LC003D / LC006D / LC009D / LC013D
FWHM / FWTM 14.0° / 24.0°
Efficiency 62 %
Peak intensity 8.5 cd/lm
LEDs/each optic 1
Light colour/type White
Required components:
F17435_HEKLA-G2-C

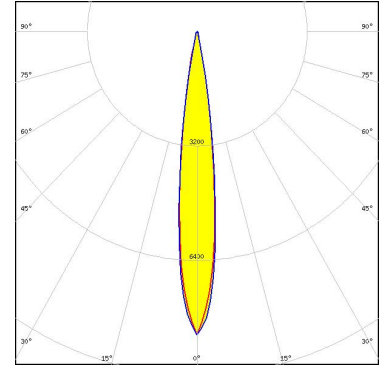

Light distribution files

SAMSUNG

LED LC010C
FWHM / FWTM 10.0° / 18.0°
Efficiency 68 %
Peak intensity 18.6 cd/lm
LEDs/each optic 1
Light colour/type White
Required components:
F17435_HEKLA-G2-C

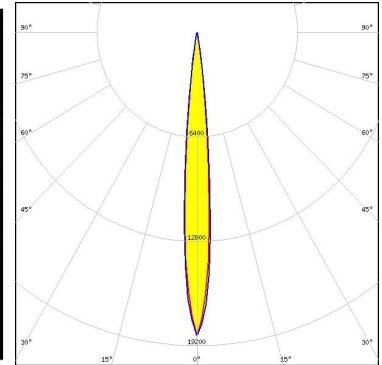

Light distribution files

GENERAL INFORMATION:

NOTE: The typical beam angle will be changed by different color, chip size and chip position tolerance. The typical total beam angle is the full angle measured where the luminous intensity is half of the peak value.

Due to use of high power COB's with this product, special attention to proper thermal design is highly recommended. LEDiL has no liability for direct, indirect or consecutive damages arising from the LEDiL products being used outside of the recommended temperature range.

MATERIALS:

As part of our continuous research and improvement processes, and to ensure the best possible quality and availability of our products, LEDiL reserves the right to change material grades without notice.

PRODUCT DATA USER AGREEMENT AND DISCLAIMER:

The measured data in the provided downloadable LEDiL Product Datasheets and Mechanical 2D-Drawings is rounded and provided as reference for planning. LEDiL Oy's optical specifications have been verified by conducting performance testing of the products in accordance with the company's quality system. The reported data are averaged results of multiple measurements with typical variation. LEDiL Oy reserves the right to without prior notification make changes and improvements to its products.

LEDiL Oy assumes neither warranty, nor guarantee nor any other liability of any kind for the contents and correctness of the provided data. The provided data has been generated with highest diligence but the provided data may in reality not represent the complete possible variation range of all intrinsic parameters. Therefore, in certain cases a deviation from the provided data could occur.

LEDiL Oy reserves the right to undertake technical changes of its products without further notification which could lead to changes in the provided data. LEDiL Oy assumes no liability of any kind for the possible deviation from any provided data or any other damage resulting from the usage of the provided data.

The user agrees to this disclaimer and user agreement with the download or usage of the provided files.

LEDiL Oy

Joensuunkatu 13
FI-24240 SALO
Finland

LEDiL Inc.

228 West Page Street
Suite D
Sycamore IL 60178
USA

Ledil Optics Technology (Shenzhen) Co., Ltd.

405 , Block B
Casic Motor Building
Shenzhen 518057
P.R.CHINA

Local sales and technical support

[www.ledil.com/
where_to_buy](http://www.ledil.com/where_to_buy)

Shipping locations

Poznan, Poland
Hong Kong, China

Distribution Partners

[www.ledil.com/
where_to_buy](http://www.ledil.com/where_to_buy)