

ILONA-M

~25° wide beam

SPECIFICATION:

Dimensions	Ø 49.8
Height	29.7 mm
Fastening	socket
ROHS compliant	yes ⓘ

MATERIALS:

Component	Type	Material	Colour	Finish	Length (mm)
ILONA-M	Single lens	PMMA	clear		



ORDERING INFORMATION:

Component	Qty in box	MOQ	MPQ	Box weight (kg)
C16687_ILONA-M » Box size: 480 x 280 x 300 mm	264	99	33	9.9

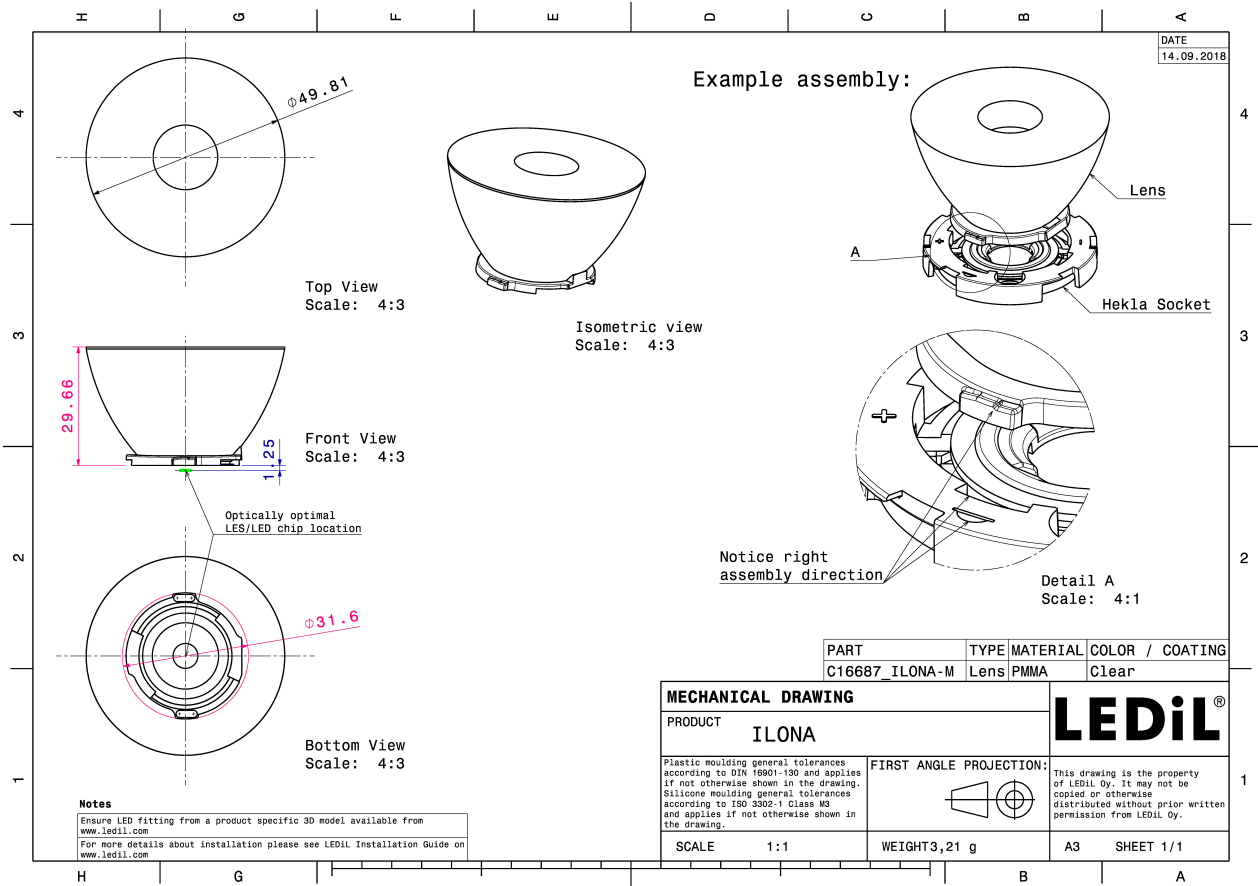

See also our general installation guide: www.ledil.com/installation_guide

OPTICAL RESULTS (MEASURED):

bridgelux

LED V11 HD Gen 8
 FWHM / FWTM 28.0° / 53.0°
 Efficiency 92 %
 Peak intensity 2.9 cd/lm
 LEDs/each optic 1
 Light colour/type White
 Required components:
 Bender Wirth: 633d Hekla

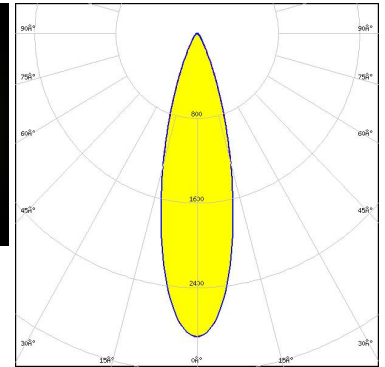
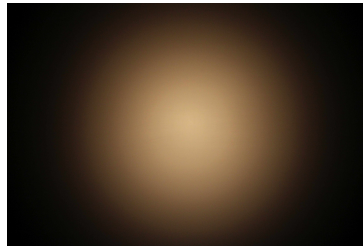

Light distribution files

bridgelux

LED V6 HD Gen 7
 FWHM / FWTM 25.0° / 44.0°
 Efficiency 95 %
 Peak intensity 4.3 cd/lm
 LEDs/each optic 1
 Light colour/type White
 Required components:
 F15255_HEKLA-SOCKET-C

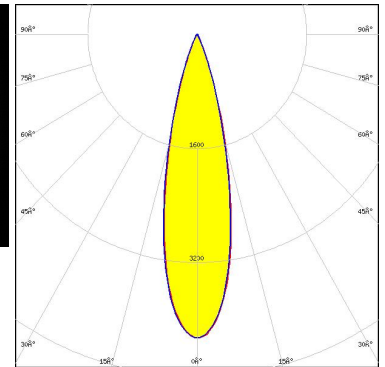
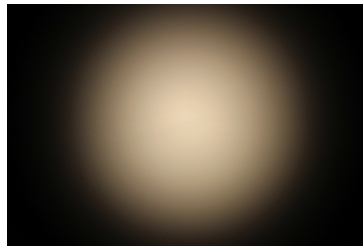

Light distribution files

bridgelux

LED V6 HD Gen 7
 FWHM / FWTM 25.0° / 44.0°
 Efficiency 95 %
 Peak intensity 4.2 cd/lm
 LEDs/each optic 1
 Light colour/type White
 Required components:
 Bender Wirth: 634c Hekla

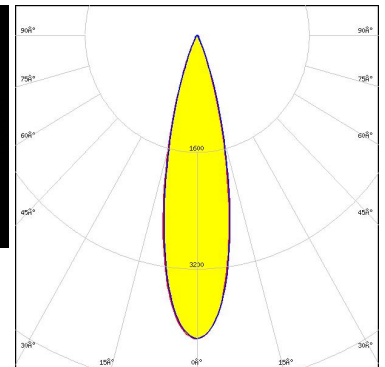
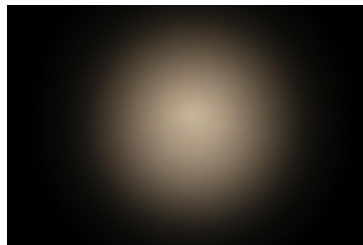

Light distribution files

OPTICAL RESULTS (MEASURED):



LED Vesta DTW 13mm (21W)
FWHM / FWTM 31.0° / 61.0°
Efficiency 90 %
Peak intensity 2.2 cd/lm
LEDs/each optic 1
Light colour/type Tunable White

Required components:

C16142_HEKLA-SOCKET-K
Bender Wirth: 491 Typ L8

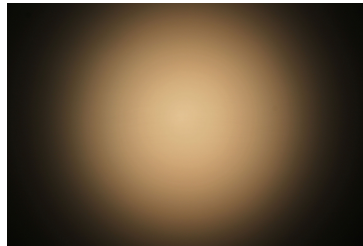

Light distribution files



LED Vesta DTW 9mm (4W/6W/12W)
FWHM / FWTM 25.0° / 48.0°
Efficiency 93 %
Peak intensity 3.6 cd/lm
LEDs/each optic 1
Light colour/type White

Required components:

C16142_HEKLA-SOCKET-K
Bender Wirth: 490 Typ L8

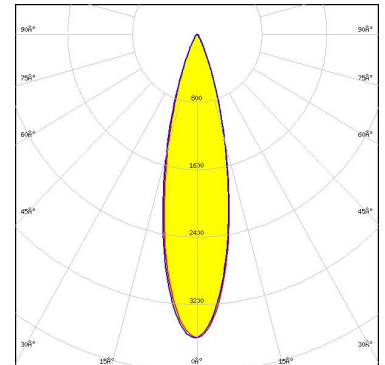

Light distribution files



LED Vesta TW 6mm DP
FWHM / FWTM 26.0° / 45.0°
Efficiency 91 %
Peak intensity 3.9 cd/lm
LEDs/each optic 1
Light colour/type White

Required components:

C16142_HEKLA-SOCKET-K
Bender Wirth: 504 Typ L8

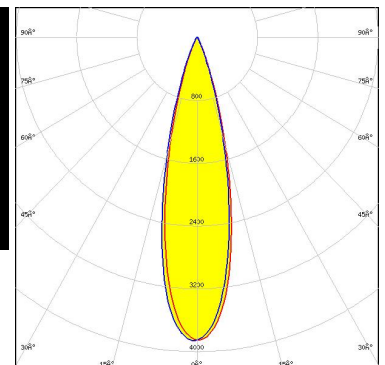
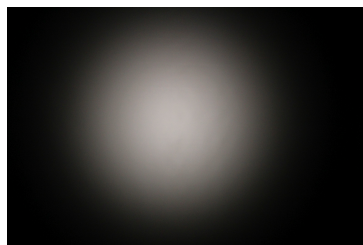

Light distribution files

OPTICAL RESULTS (MEASURED):

CITIZEN

LED CLU7A2/7A3
 FWHM / FWTM 25.0° / 41.0°
 Efficiency 94 %
 Peak intensity 4.7 cd/lm
 LEDs/each optic 1
 Light colour/type White
 Required components:
 F15255_HEKLA-SOCKET-C

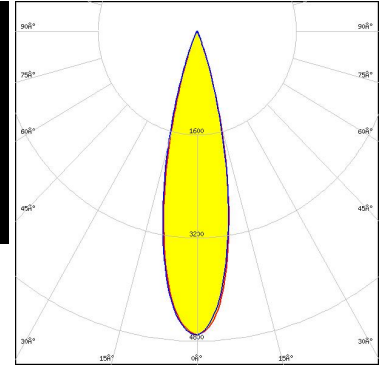

Light distribution files

CITIZEN

LED CLU7B2
 FWHM / FWTM 25.0° / 41.0°
 Efficiency 94 %
 Peak intensity 4.5 cd/lm
 LEDs/each optic 1
 Light colour/type White
 Required components:
 F15255_HEKLA-SOCKET-C

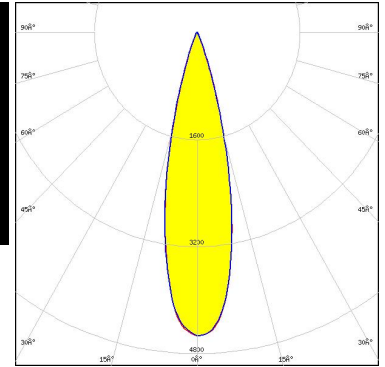

Light distribution files

LUMILEDS

LED LUXEON CX Plus CoB L08 (Gen2)
 FWHM / FWTM 32.0° / 62.0°
 Efficiency 92 %
 Peak intensity 2.2 cd/lm
 LEDs/each optic 1
 Light colour/type White
 Required components:
 Bender Wirth: 637a Hekla

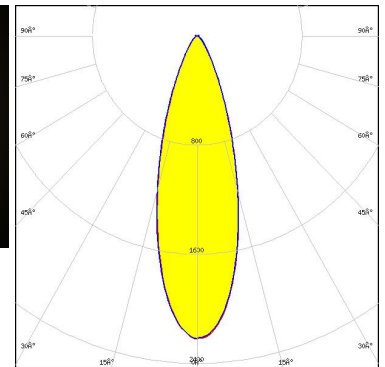
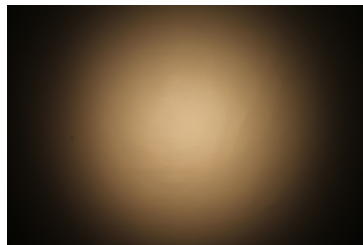

Light distribution files

OPTICAL RESULTS (MEASURED):



LED LUXEON CX Plus CoB - HD S01H4
FWHM / FWTM 25.0° / 43.0°
Efficiency 94 %
Peak intensity 4.5 cd/lm
LEDs/each optic 1
Light colour/type White
Required components:
 Bender Wirth: 634c Hekla

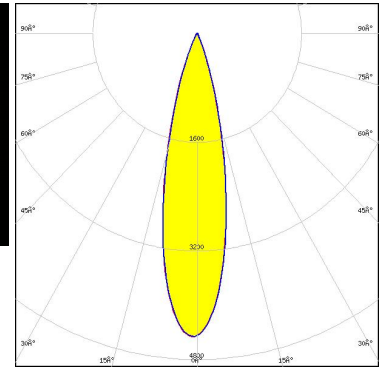
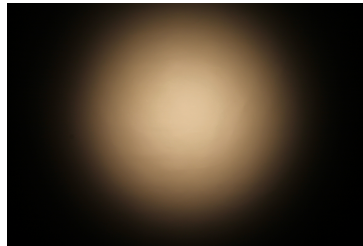

Light distribution files



LED LUXEON CX Plus CoB - HD S02H6
FWHM / FWTM 25.0° / 44.0°
Efficiency 94 %
Peak intensity 4.3 cd/lm
LEDs/each optic 1
Light colour/type White
Required components:
 Bender Wirth: 634c Hekla

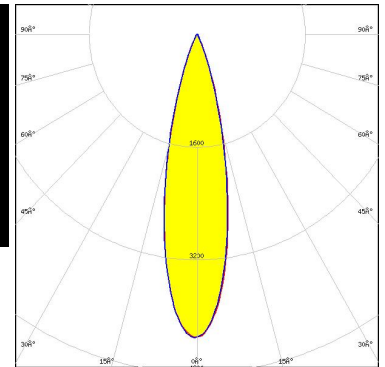
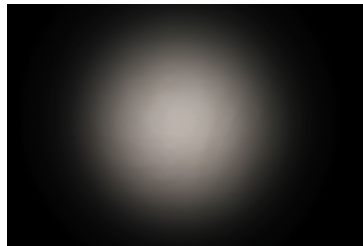

Light distribution files



LED LUXEON CX Plus CoB - HD S04H9
FWHM / FWTM 25.0° / 48.0°
Efficiency 94 %
Peak intensity 3.8 cd/lm
LEDs/each optic 1
Light colour/type White
Required components:
 Bender Wirth: 634c Hekla

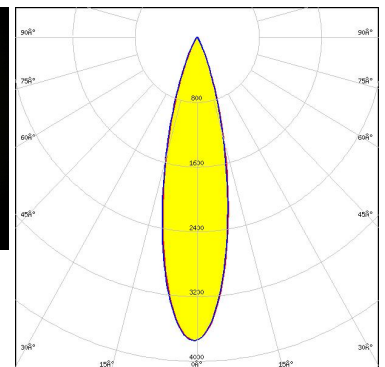
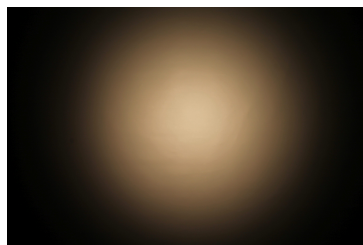

Light distribution files

OPTICAL RESULTS (MEASURED):



LED LUXEON CX Plus CoB L04 / L05 (Gen2)
FWHM / FWTM 28.0° / 54.0°
Efficiency 93 %
Peak intensity 2.9 cd/lm
LEDs/each optic 1
Light colour/type White
Required components:
Bender Wirth: 637a Hekla

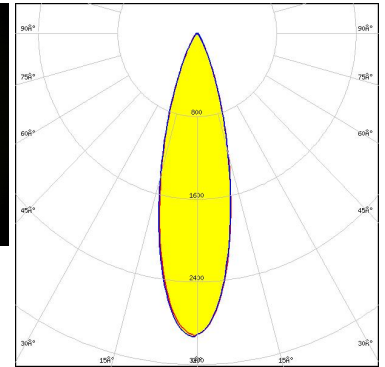
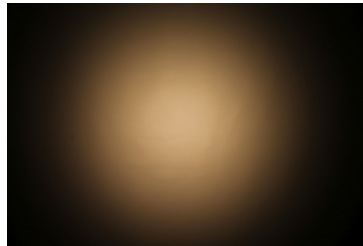

Light distribution files



LED LUXEON CX Plus CoB M02 / M03 (Gen2)
FWHM / FWTM 25.0° / 48.0°
Efficiency 94 %
Peak intensity 3.8 cd/lm
LEDs/each optic 1
Light colour/type White
Required components:
Bender Wirth: 641a Hekla

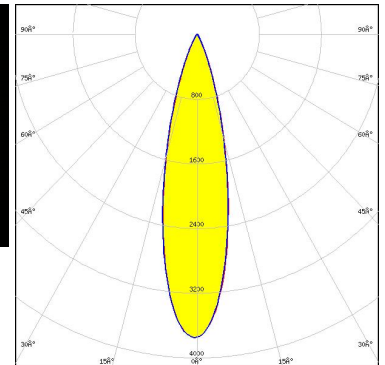
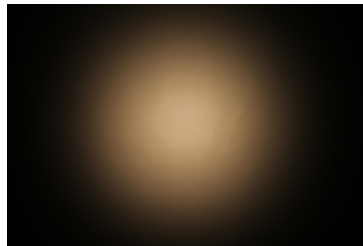

Light distribution files



LED LUXEON CX Plus CoB S01 (Gen2)
FWHM / FWTM 25.0° / 44.0°
Efficiency 94 %
Peak intensity 4.3 cd/lm
LEDs/each optic 1
Light colour/type White
Required components:
Bender Wirth: 634c Hekla

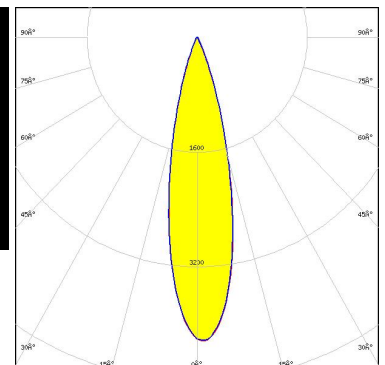
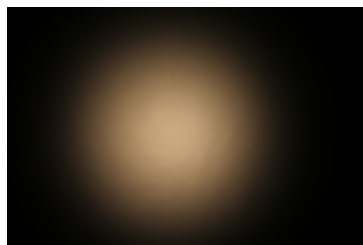

Light distribution files

OPTICAL RESULTS (MEASURED):



LED LUXEON Fusion 21-up (20x24)
FWHM / FWTM 25.0° / 47.0°
Efficiency 94 %
Peak intensity 3.7 cd/lm
LEDs/each optic 21
Light colour/type White
Required components:
C16142_HEKLA-SOCKET-K
Bender Wirth: 442 Typ L8

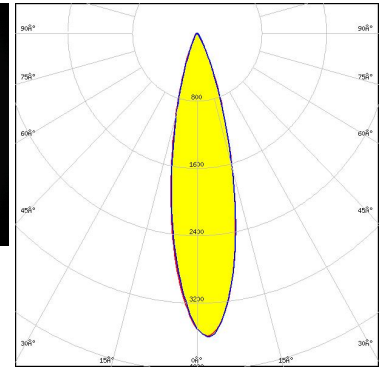
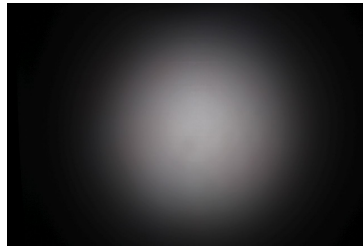

Light distribution files



LED CXM-3
FWHM / FWTM 25.0° / 41.0°
Efficiency 94 %
Peak intensity 4.6 cd/lm
LEDs/each optic 1
Light colour/type White
Required components:
F15255_HEKLA-SOCKET-C

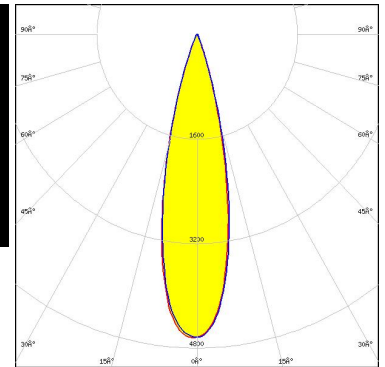

Light distribution files



LED CXM-4
FWHM / FWTM 24.0° / 42.0°
Efficiency 92 %
Peak intensity 4.4 cd/lm
LEDs/each optic 1
Light colour/type White
Required components:
F15255_HEKLA-SOCKET-C

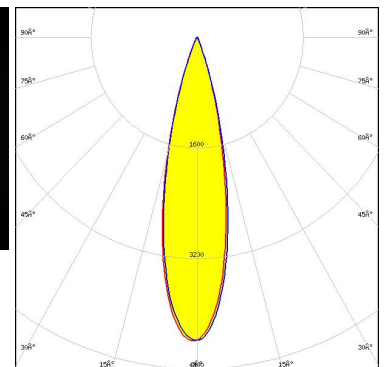
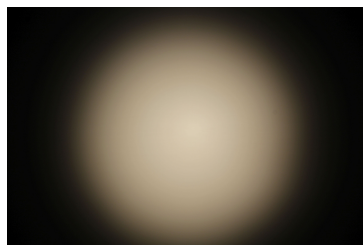

Light distribution files

OPTICAL RESULTS (MEASURED):

OSRAM
Opto Semiconductors

LED OSTAR Stage (S2WN)
FWHM / FWTM 25.0° / 41.0°
Efficiency 94 %
Peak intensity 4.7 cd/lm
LEDs/each optic 1
Light colour/type White
Required components:
F15859_HEKLA-SOCKET-I

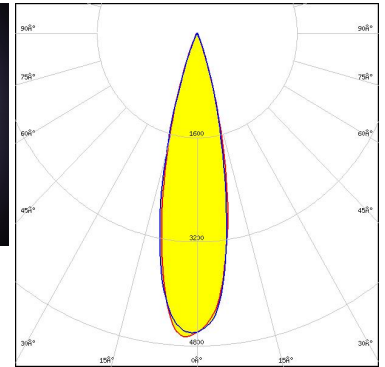
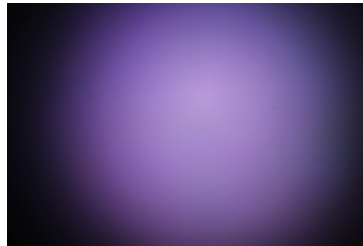

Light distribution files

OSRAM
Opto Semiconductors

LED OSTAR Stage (S2WP)
FWHM / FWTM 25.0° / 41.0°
Efficiency 94 %
Peak intensity 4.6 cd/lm
LEDs/each optic 1
Light colour/type White
Required components:
F15859_HEKLA-SOCKET-I

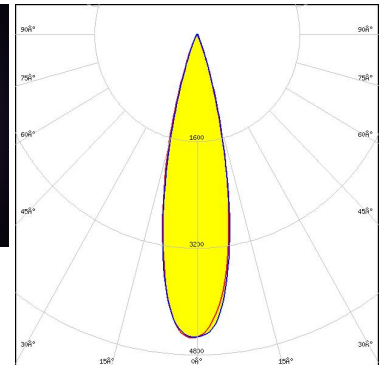
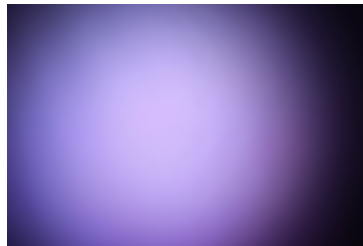

Light distribution files

SAMSUNG

LED LC010T (Tunable White)
FWHM / FWTM 26.0° / 51.0°
Efficiency 88 %
Peak intensity 2.9 cd/lm
LEDs/each optic 1
Light colour/type Tunable White
Required components:
C16142_HEKLA-SOCKET-K
Bender Wirth: 501 Typ L8

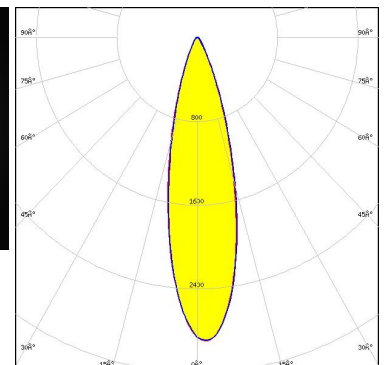
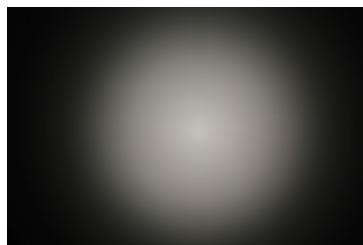

Light distribution files

OPTICAL RESULTS (MEASURED):

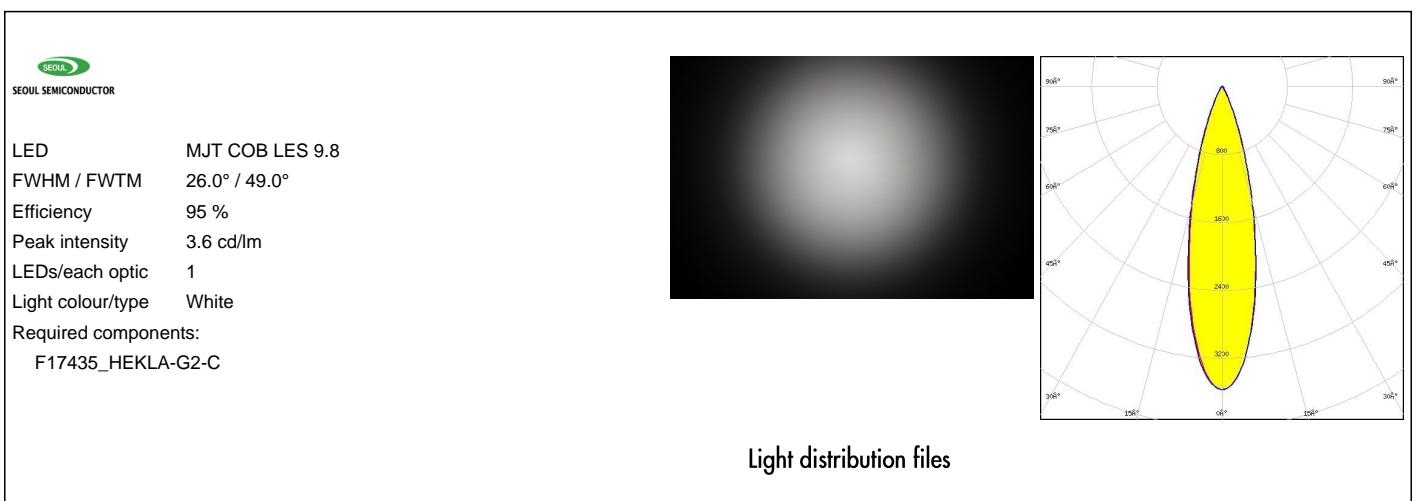
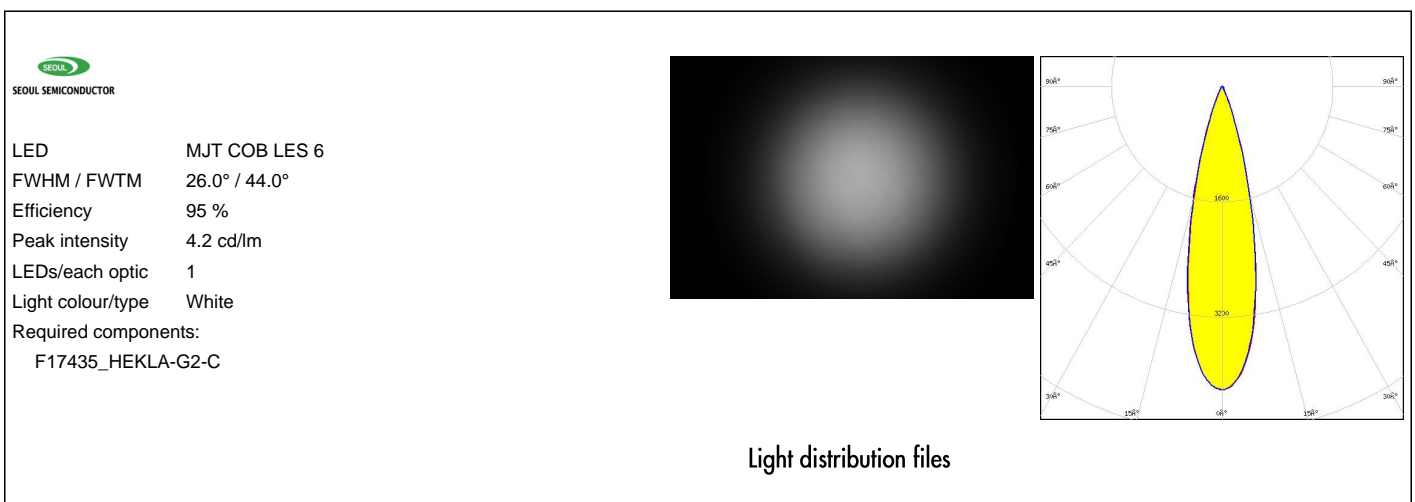
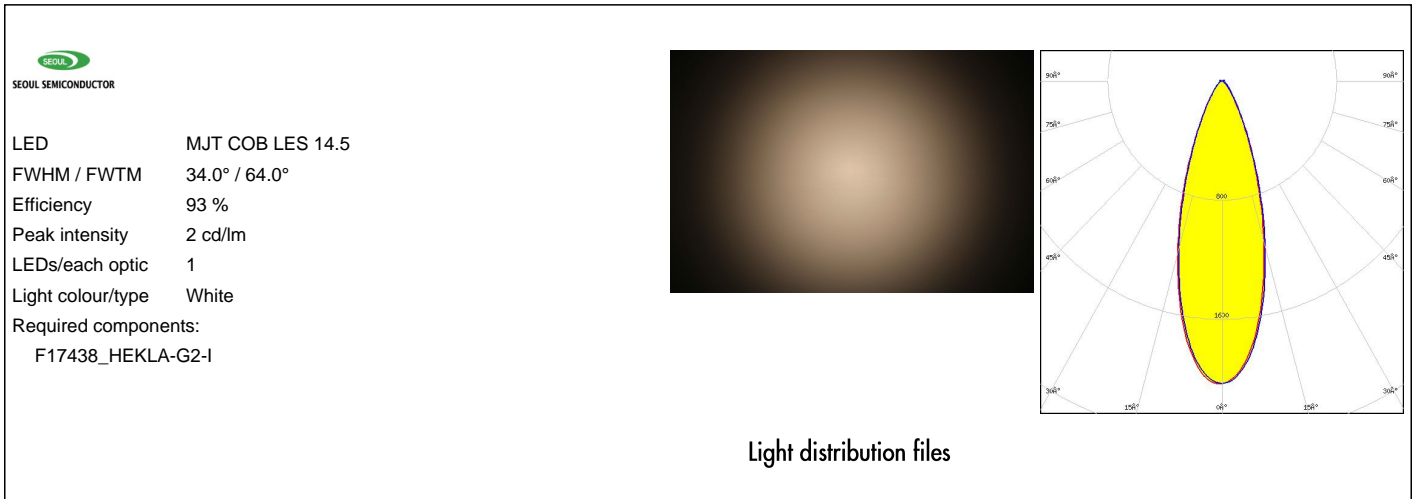

OPTICAL RESULTS (MEASURED):

TRIDONIC

LED SLE G7 LES09
FWHM / FWTM 25.0° / 48.0°
Efficiency 94 %
Peak intensity 3.7 cd/lm
LEDs/each optic 1
Light colour/type White
Required components:
F15255_HEKLA-SOCKET-C



Light distribution files

XICATO

LED XOB 6 mm
FWHM / FWTM 24.0° / 44.0°
Efficiency 94 %
Peak intensity 4.4 cd/lm
LEDs/each optic 1
Light colour/type White
Required components:
F15255_HEKLA-SOCKET-C

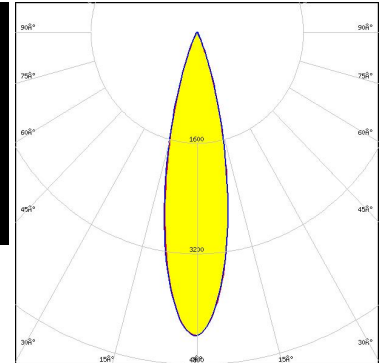

Light distribution files

XICATO

LED XOB 9.8 mm
FWHM / FWTM 26.0° / 48.0°
Efficiency 94 %
Peak intensity 3.7 cd/lm
LEDs/each optic 1
Light colour/type White
Required components:
F15255_HEKLA-SOCKET-C

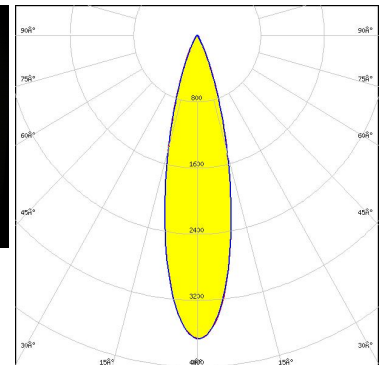
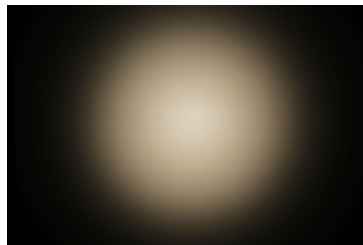

Light distribution files

OPTICAL RESULTS (SIMULATED):

bridgelux

LED V13 Gen 8-9
FWHM / FWTM 32.0° / 61.0°
Efficiency 90 %
Peak intensity 2.3 cd/lm
LEDs/each optic 1
Light colour/type White

Required components:

F15859_HEKLA-SOCKET-I

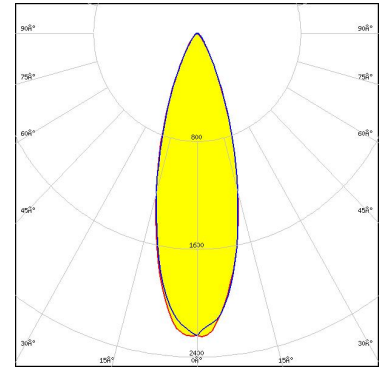

Light distribution files

bridgelux

LED V4 HD Gen 7
FWHM / FWTM 26.0° / 44.0°
Efficiency 93 %
Peak intensity 4.3 cd/lm
LEDs/each optic 1
Light colour/type White

Required components:

F15253_HEKLA-SOCKET-A

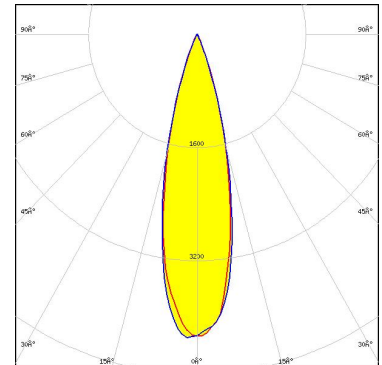

Light distribution files

bridgelux

LED V6 HD Gen 7
FWHM / FWTM 26.0° / 46.0°
Efficiency 94 %
Peak intensity 4.1 cd/lm
LEDs/each optic 1
Light colour/type White

Required components:

F15255_HEKLA-SOCKET-C

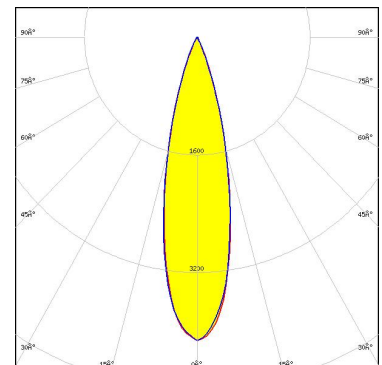

Light distribution files

OPTICAL RESULTS (SIMULATED):



LED V9 HD Gen7
 FWHM / FWTM 26.0° / 48.0°
 Efficiency 93 %
 Peak intensity 3.7 cd/lm
 LEDs/each optic 1
 Light colour/type White

Required components:
 F15859_HEKLA-SOCKET-I

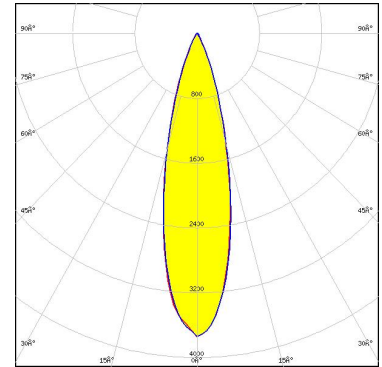

Light distribution files



LED Vero SE 10
 FWHM / FWTM 26.0° / 48.0°
 Efficiency 93 %
 Peak intensity 3.7 cd/lm
 LEDs/each optic 1
 Light colour/type White

Required components:

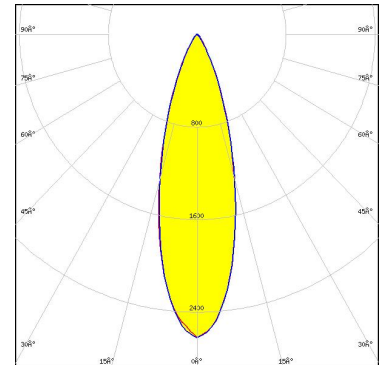

Light distribution files

CITIZEN

LED CLL02x/CLU02x (LES10)
 FWHM / FWTM 26.0° / 49.0°
 Efficiency 91 %
 Peak intensity 3.7 cd/lm
 LEDs/each optic 1
 Light colour/type White

Required components:
 F15255_HEKLA-SOCKET-C

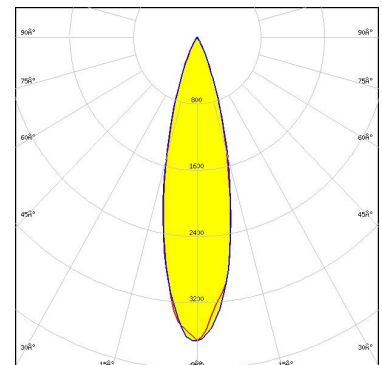

Light distribution files

OPTICAL RESULTS (SIMULATED):

CITIZEN

LED CLU700/701/702/703
FWHM / FWTM 26.0° / 45.0°
Efficiency 92 %
Peak intensity 4.2 cd/lm
LEDs/each optic 1
Light colour/type White
Required components:
F15255_HEKLA-SOCKET-C

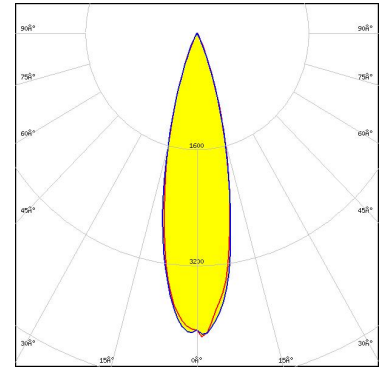

Light distribution files

CITIZEN

LED CLU710/711
FWHM / FWTM 26.0° / 48.0°
Efficiency 91 %
Peak intensity 3.8 cd/lm
LEDs/each optic 1
Light colour/type White
Required components:
F15859_HEKLA-SOCKET-I

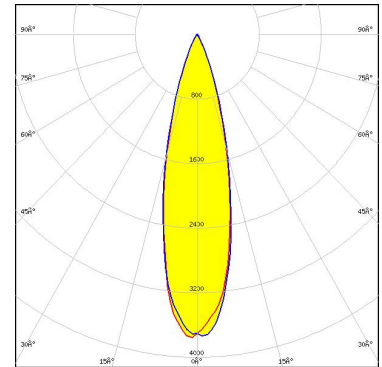

Light distribution files

CITIZEN

LED CLU712/713
FWHM / FWTM 28.0° / 50.0°
Efficiency 94 %
Peak intensity 3.5 cd/lm
LEDs/each optic 1
Light colour/type White
Required components:
F17438_HEKLA-G2-I

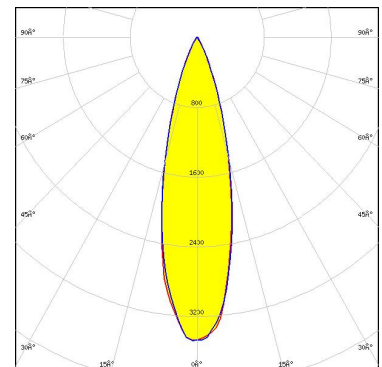

Light distribution files

OPTICAL RESULTS (SIMULATED):



LED: CHA0304
FWHM / FWTM: 25.0° / 42.0°
Efficiency: 94 %
Peak intensity: 4.6 cd/lm
LEDs/each optic: 1
Light colour/type: White
Required components:
F17435_HEKLA-G2-C

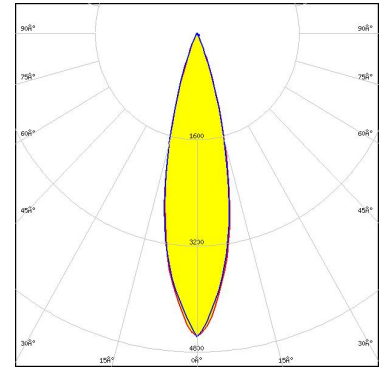

Light distribution files



LED: CHA0410
FWHM / FWTM: 26.0° / 44.0°
Efficiency: 94 %
Peak intensity: 4.4 cd/lm
LEDs/each optic: 1
Light colour/type: White
Required components:
F17435_HEKLA-G2-C

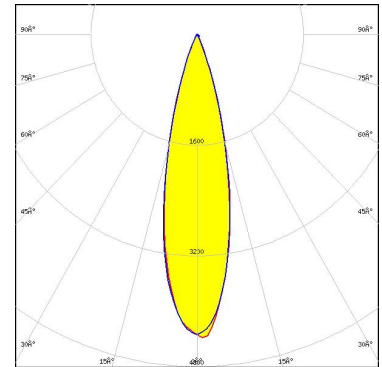

Light distribution files



LED: CMA1825
FWHM / FWTM: 30.0° / 56.0°
Efficiency: 91 %
Peak intensity: 2.7 cd/lm
LEDs/each optic: 1
Light colour/type: White
Required components:
F15254_HEKLA-SOCKET-B

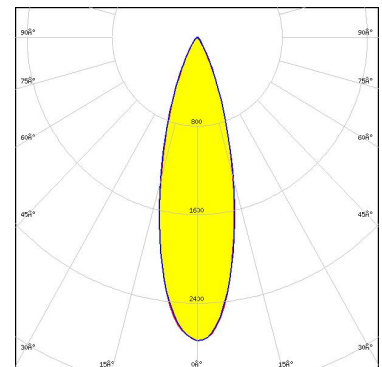

Light distribution files

OPTICAL RESULTS (SIMULATED):



LED CXA/B 13xx
 FWHM / FWTM 25.0° / 45.0°
 Efficiency 91 %
 Peak intensity 4.2 cd/lm
 LEDs/each optic 1
 Light colour/type White

Required components:
 F15956_HEKLA-SOCKET-J

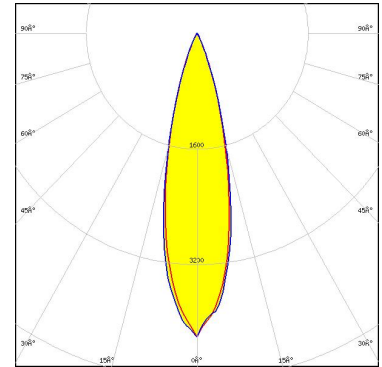

Light distribution files



LED CXA/B 15xx
 FWHM / FWTM 26.0° / 49.0°
 Efficiency 92 %
 Peak intensity 3.6 cd/lm
 LEDs/each optic 1
 Light colour/type White

Required components:
 F15256_HEKLA-SOCKET-D

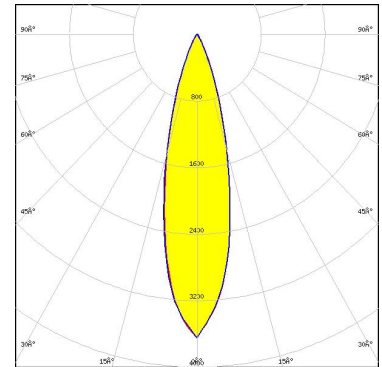

Light distribution files



LED CXA/B 1816 & CXA/B 1820 & CXA 1850
 FWHM / FWTM 28.0° / 55.0°
 Efficiency 94 %
 Peak intensity 2.9 cd/lm
 LEDs/each optic 1
 Light colour/type White

Required components:
 F15254_HEKLA-SOCKET-B

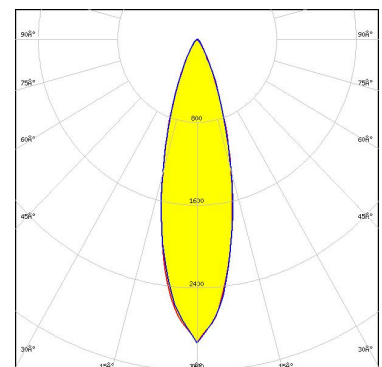

Light distribution files

OPTICAL RESULTS (SIMULATED):



LED LUXEON CoB 1202/1203
FWHM / FWTM 26.0° / 50.0°
Efficiency 92 %
Peak intensity 3.7 cd/lm
LEDs/each optic 1
Light colour/type White
Required components:
F17437_HEKLA-G2-H

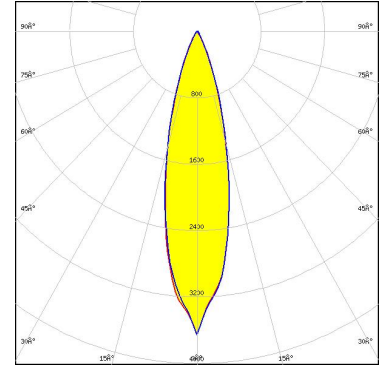

Light distribution files



LED LUXEON CoB 1202s
FWHM / FWTM 26.0° / 48.0°
Efficiency 95 %
Peak intensity 3.8 cd/lm
LEDs/each optic 1
Light colour/type White
Required components:

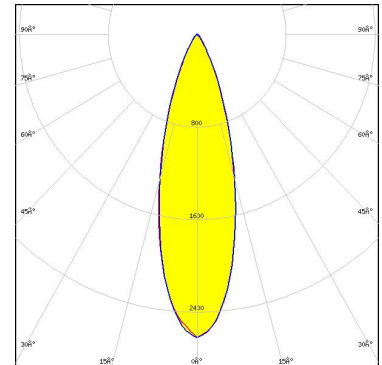

Light distribution files



LED LUXEON CoB 1204/1205
FWHM / FWTM 30.0° / 58.0°
Efficiency 91 %
Peak intensity 2.6 cd/lm
LEDs/each optic 1
Light colour/type White
Required components:

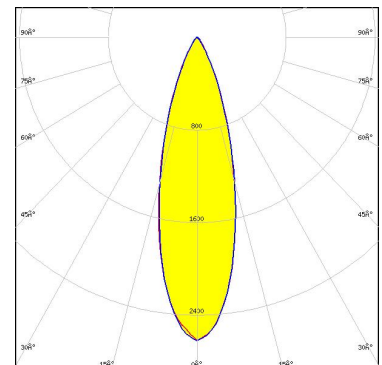

Light distribution files

OPTICAL RESULTS (SIMULATED):



LED LUXEON CoB 1208
FWHM / FWTM 32.0° / 60.0°
Efficiency 88 %
Peak intensity 2.3 cd/lm
LEDs/each optic 1
Light colour/type White
Required components:

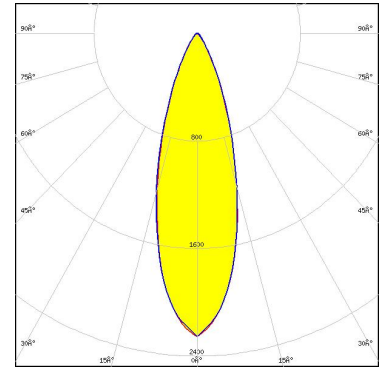

Light distribution files



LED LUXEON Rubix
FWHM / FWTM 25.0° / 43.0°
Efficiency 94 %
Peak intensity 4.4 cd/lm
LEDs/each optic 4
Light colour/type RGBW
Required components:

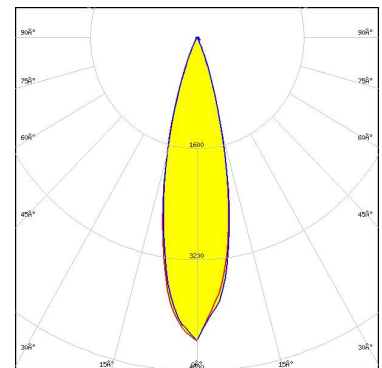
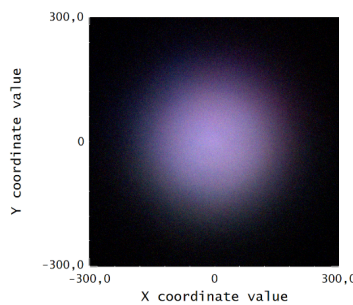

Light distribution files



LED COB S-Type (LES 6)
FWHM / FWTM 26.0° / 46.0°
Efficiency 92 %
Peak intensity 4.1 cd/lm
LEDs/each optic 1
Light colour/type White
Required components:
 F15848_HEKLA-SOCKET-G

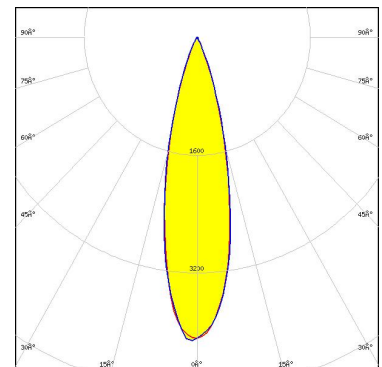

Light distribution files

OPTICAL RESULTS (SIMULATED):



LED COB S-Type (LES 7)
FWHM / FWTM 26.0° / 46.0°
Efficiency 94 %
Peak intensity 4.1 cd/lm
LEDs/each optic 1
Light colour/type White
Required components:
F15848_HEKLA-SOCKET-G

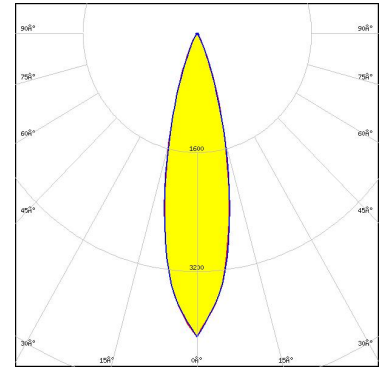

Light distribution files



LED NFSWE11A
FWHM / FWTM 26.0° / 48.0°
Efficiency 87 %
Peak intensity 3.4 cd/lm
LEDs/each optic 30
Light colour/type White
Required components:
C16142_HEKLA-SOCKET-K

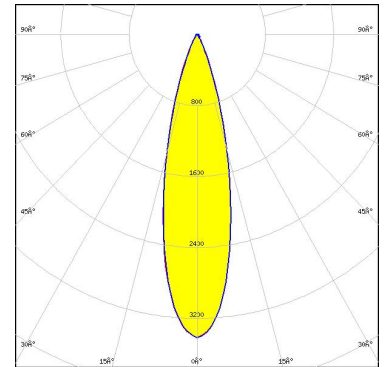

Light distribution files



LED Fortimo SLM L13 CoB
FWHM / FWTM 29.0° / 56.0°
Efficiency 91 %
Peak intensity 2.6 cd/lm
LEDs/each optic 1
Light colour/type White
Required components:

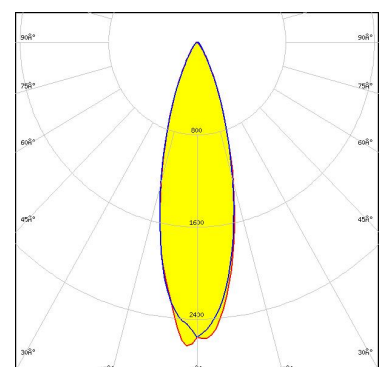

Bender Wirth: 632a Hekla XL

Light distribution files

OPTICAL RESULTS (SIMULATED):

PHILIPS

LED	Fortimo SLM L15 CoB
FWHM / FWTM	32.0° / 62.0°
Efficiency	89 %
Peak intensity	2.2 cd/lm
LEDs/each optic	1
Light colour/type	White
Required components:	

Bender Wirth: 632a Hekla XL

Light distribution files

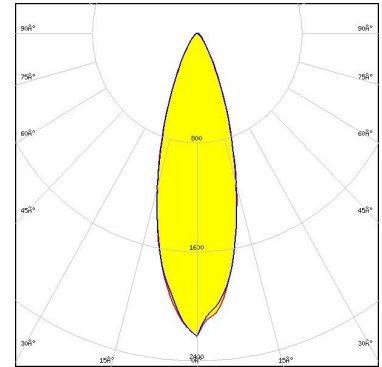

SAMSUNG

LED	LC010C
FWHM / FWTM	26.0° / 46.0°
Efficiency	92 %
Peak intensity	4.1 cd/lm
LEDs/each optic	1
Light colour/type	White
Required components:	

F15848_HEKLA-SOCKET-G

Light distribution files

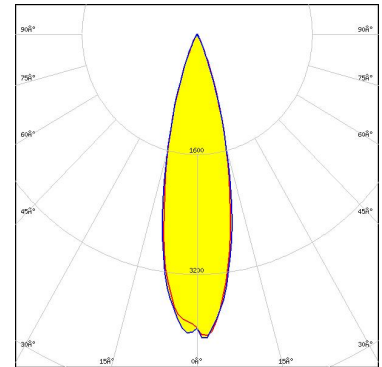

SAMSUNG

LED	LC020C
FWHM / FWTM	26.0° / 46.0°
Efficiency	93 %
Peak intensity	4.1 cd/lm
LEDs/each optic	1
Light colour/type	White
Required components:	

F17438_HEKLA-G2-I

Light distribution files

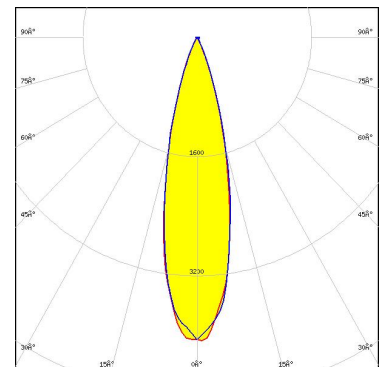

GENERAL INFORMATION:

NOTE: The typical beam angle will be changed by different color, chip size and chip position tolerance. The typical total beam angle is the full angle measured where the luminous intensity is half of the peak value.

Due to use of high power COB's with this product, special attention to proper thermal design is highly recommended. LEDiL has no liability for direct, indirect or consecutive damages arising from the LEDiL products being used outside of the recommended temperature range.

MATERIALS:

As part of our continuous research and improvement processes, and to ensure the best possible quality and availability of our products, LEDiL reserves the right to change material grades without notice.

PRODUCT DATA USER AGREEMENT AND DISCLAIMER:

The measured data in the provided downloadable LEDiL Product Datasheets and Mechanical 2D-Drawings is rounded and provided as reference for planning. LEDiL Oy's optical specifications have been verified by conducting performance testing of the products in accordance with the company's quality system. The reported data are averaged results of multiple measurements with typical variation. LEDiL Oy reserves the right to without prior notification make changes and improvements to its products.

LEDiL Oy assumes neither warranty, nor guarantee nor any other liability of any kind for the contents and correctness of the provided data. The provided data has been generated with highest diligence but the provided data may in reality not represent the complete possible variation range of all intrinsic parameters. Therefore, in certain cases a deviation from the provided data could occur.

LEDiL Oy reserves the right to undertake technical changes of its products without further notification which could lead to changes in the provided data. LEDiL Oy assumes no liability of any kind for the possible deviation from any provided data or any other damage resulting from the usage of the provided data.

The user agrees to this disclaimer and user agreement with the download or usage of the provided files.

LEDiL Oy

Joensuunkatu 7
FI-24240 SALO
Finland

LEDiL Inc.

228 West Page Street
Suite D
Sycamore IL 60178
USA

Ledil Optics Technology (Shenzhen) Co., Ltd.

405 , Block B
Casic Motor Building
Shenzhen 518057
P.R.CHINA

Local sales and technical support

[www.ledil.com/
where_to_buy](http://www.ledil.com/where_to_buy)

Shipping locations

Poznan, Poland
Hong Kong, China

Distribution Partners

[www.ledil.com/
where_to_buy](http://www.ledil.com/where_to_buy)