

IRIS

~10° spot beam with holder

SPECIFICATION:

Dimensions	Ø 38.0
Height	28.5 mm
Fastening	glue, screw
ROHS compliant	yes ⓘ

MATERIALS:

Component	Type	Material	Colour	Finish	Length (mm)
IRIS	Single lens	PMMA	clear		
IRIS-HLD	Holder	PC	black		



ORDERING INFORMATION:

Quantities for one set:

Single lens	1
Holder	1

Component		Qty in box	MOQ	MPQ	Box weight (kg)
C10781_IRIS	Single lens	580	116	58	9.0
» Box size: 480 x 280 x 300 mm					
C10860_IRIS-HLD	Holder	1044	116	29	7.2
» Box size: 480 x 280 x 300 mm					

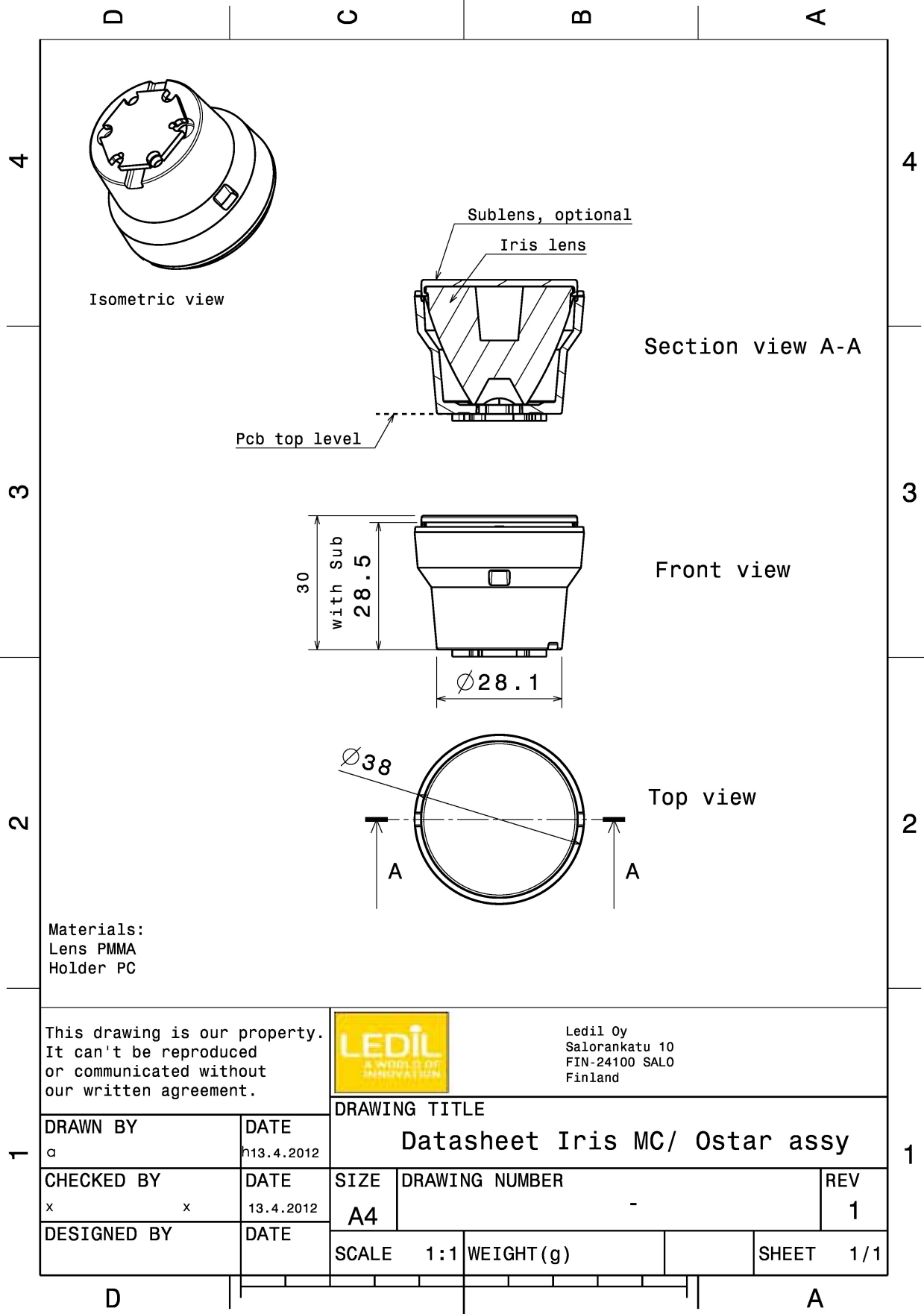

This drawing is our property. It can't be reproduced or communicated without our written agreement.



Ledil Oy
Salorankatu 10
FIN-24100 SALO
Finland

DRAWING TITLE

Datasheet Iris MC/ Ostar assy

DRAWN BY: a

DATE: 13.4.2012

CHECKED BY: x x

DATE: 13.4.2012

SIZE: A4

DRAWING NUMBER: -

REV: 1

DESIGNED BY:

DATE:

SCALE: 1:1

WEIGHT (g):

SHEET: 1/1

See also our general installation guide: www.ledil.com/installation_guide

OPTICAL RESULTS (MEASURED):



LED MC-E
FWHM / FWTM 11.0° / 24.0°
Efficiency 89 %
Peak intensity 15 cd/lm
LEDs/each optic 1
Light colour/type White
Required components:

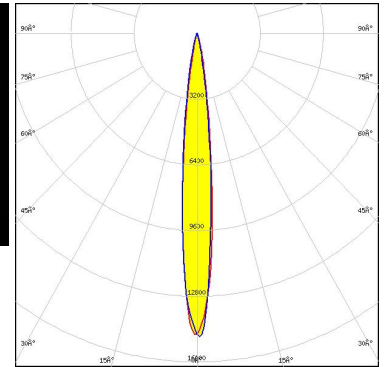
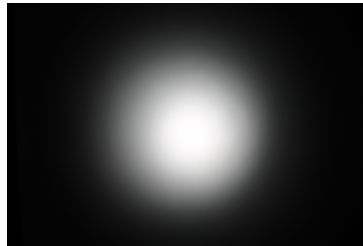

Light distribution files



LED MHD-E/G
FWHM / FWTM 17.0° / 37.0°
Efficiency 91 %
Peak intensity 5.7 cd/lm
LEDs/each optic 1
Light colour/type White
Required components:

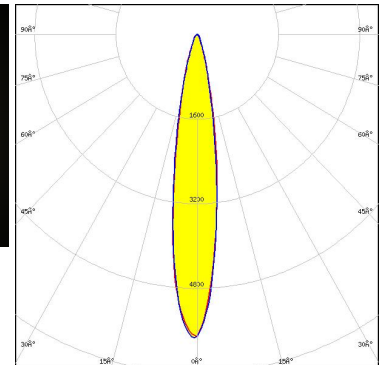
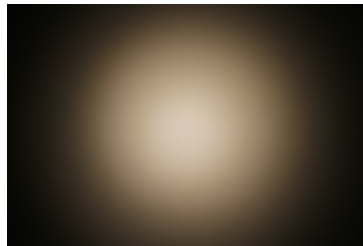

Light distribution files



LED XHP50
FWHM / FWTM 16.0° / 33.0°
Efficiency 81 %
Peak intensity 6.6 cd/lm
LEDs/each optic 1
Light colour/type White
Required components:

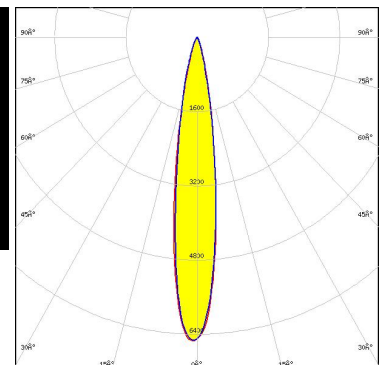
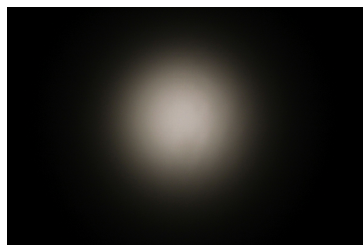

Light distribution files

OPTICAL RESULTS (MEASURED):



LED XHP50.2
 FWHM / FWTM 16.0° / 30.0°
 Efficiency 83 %
 Peak intensity 8.2 cd/lm
 LEDs/each optic 1
 Light colour/type White
 Required components:

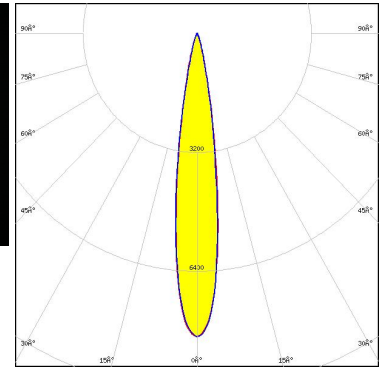

Light distribution files



LED LUXEON CZ
 FWHM / FWTM 5.0° / 11.0°
 Efficiency 80 %
 Peak intensity 57 cd/lm
 LEDs/each optic 1
 Light colour/type White
 Required components:

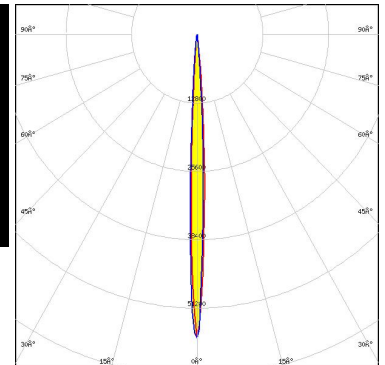

Light distribution files



LED LUXEON M/MX
 FWHM / FWTM 16.0° / 30.0°
 Efficiency 87 %
 Peak intensity 9.1 cd/lm
 LEDs/each optic 1
 Light colour/type White
 Required components:

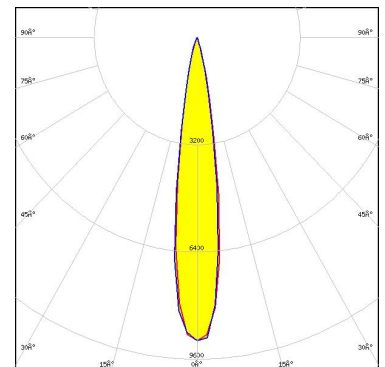

Light distribution files

OPTICAL RESULTS (MEASURED):



LED LUXEON MZ
FWHM / FWTM 12.0° / 22.0°
Efficiency 82 %
Peak intensity 15.8 cd/lm
LEDs/each optic 1
Light colour/type White
Required components:

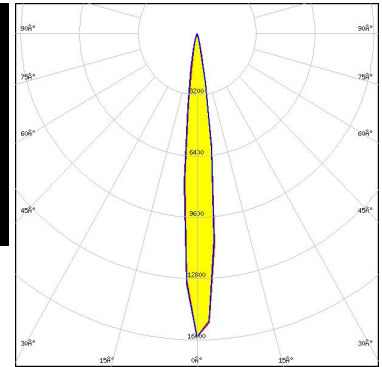

Light distribution files



LED NFMW48xA
FWHM / FWTM 12.0° / 25.0°
Efficiency 84 %
Peak intensity 12.8 cd/lm
LEDs/each optic 1
Light colour/type White
Required components:

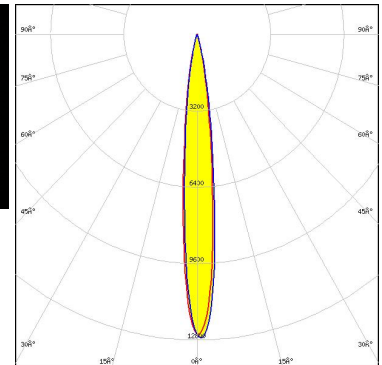
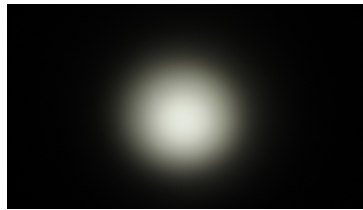

Light distribution files



LED Duris S10
FWHM / FWTM 13.0° / 29.0°
Efficiency 79 %
Peak intensity 8.8 cd/lm
LEDs/each optic 1
Light colour/type White
Required components:

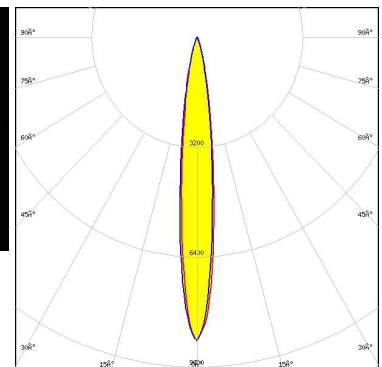
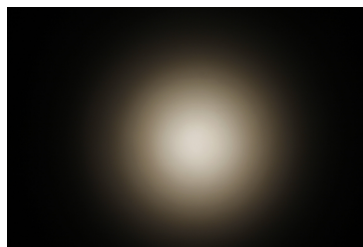

Light distribution files

OPTICAL RESULTS (MEASURED):

OSRAM
Opto Semiconductors

LED Duris S8
FWHM / FWTM 11.0° / 24.0°
Efficiency %
LEDs/each optic 1
Light colour/type White
Required components:



Light distribution files

SEUL
SEOUL SEMICONDUCTOR

LED WICOP 5050
FWHM / FWTM 16.0° / 36.0°
Efficiency 77 %
Peak intensity 5.8 cd/lm
LEDs/each optic 1
Light colour/type White
Required components:

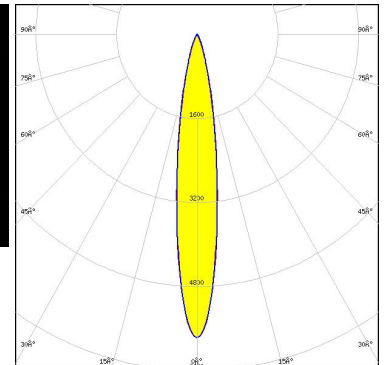

Light distribution files

SEUL
SEOUL SEMICONDUCTOR

LED Z5M1/Z5M2
FWHM / FWTM 7.0° / 14.0°
Efficiency 83 %
Peak intensity 40.4 cd/lm
LEDs/each optic 1
Light colour/type White
Required components:



Light distribution files

OPTICAL RESULTS (SIMULATED):



LED Bridgelux SMD 5050
FWHM / FWTM 13.0° / 25.0°
Efficiency 91 %
Peak intensity 13.2 cd/lm
LEDs/each optic 1
Light colour/type White
Required components:

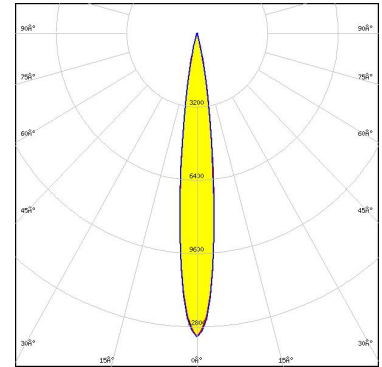

Light distribution files



LED J Series 5050B 6V K Class
FWHM / FWTM 12.0° / 24.0°
Efficiency 90 %
Peak intensity 14.2 cd/lm
LEDs/each optic 1
Light colour/type White
Required components:

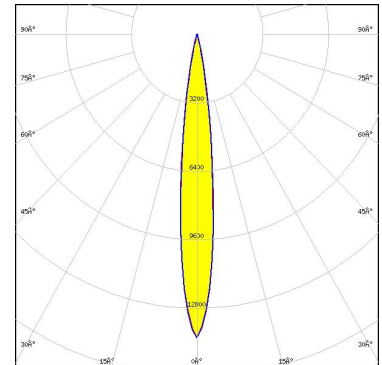

Light distribution files



LED J Series 5050C 6V E Class
FWHM / FWTM 12.0° / 24.0°
Efficiency 89 %
Peak intensity 15.1 cd/lm
LEDs/each optic 1
Light colour/type White
Required components:

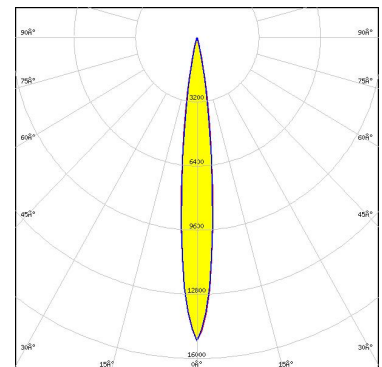

Light distribution files

OPTICAL RESULTS (SIMULATED):



LED XD16
 FWHM / FWTM 8.0° / 16.0°
 Efficiency 82 %
 Peak intensity 30.1 cd/m
 LEDs/each optic 1
 Light colour/type White
 Required components:

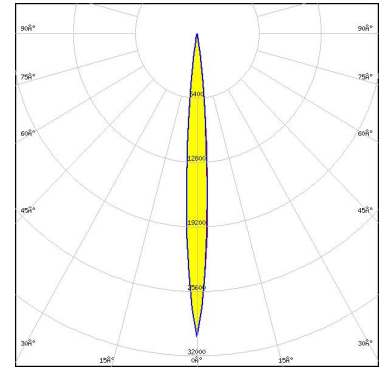

Light distribution files



LED XHP35 HD
 FWHM / FWTM 11.0° / 22.0°
 Efficiency 91 %
 Peak intensity 18.3 cd/m
 LEDs/each optic 1
 Light colour/type White
 Required components:

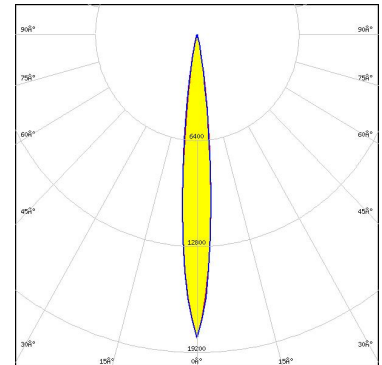

Light distribution files



LED XHP35 HI
 FWHM / FWTM 10.0° / 18.0°
 Efficiency 90 %
 Peak intensity 26.9 cd/m
 LEDs/each optic 1
 Light colour/type White
 Required components:

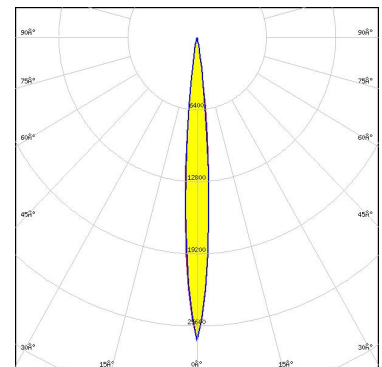

Light distribution files

OPTICAL RESULTS (SIMULATED):



LED XHP35.2 HD
 FWHM / FWTM 12.0° / 26.0°
 Efficiency 87 %
 Peak intensity 12.5 cd/m
 LEDs/each optic 1
 Light colour/type White
 Required components:

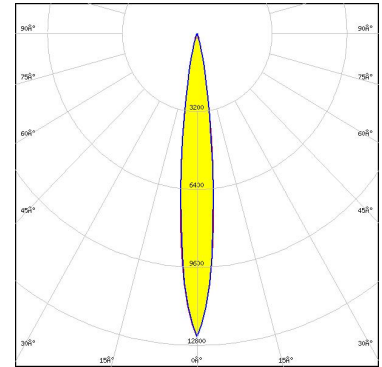

Light distribution files



LED XHP50
 FWHM / FWTM 16.0° / 27.0°
 Efficiency 89 %
 Peak intensity 10.6 cd/m
 LEDs/each optic 1
 Light colour/type White
 Required components:

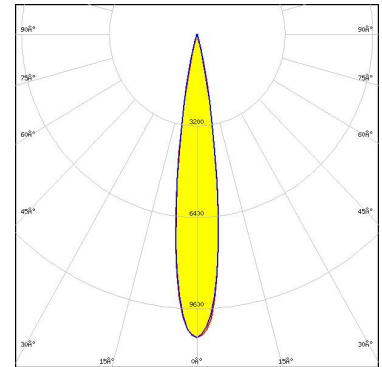

Light distribution files



LED XHP50.3 HD
 FWHM / FWTM 14.0° / 24.0°
 Efficiency 87 %
 Peak intensity 13.3 cd/m
 LEDs/each optic 1
 Light colour/type White
 Required components:

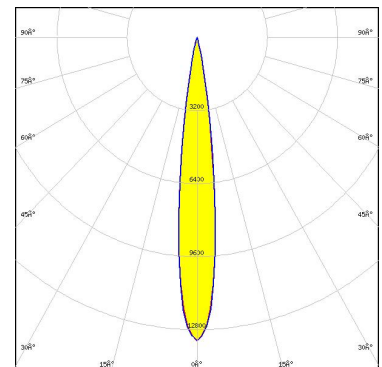

Light distribution files

OPTICAL RESULTS (SIMULATED):



LED XHP50.3 HI
 FWHM / FWTM 12.0° / 22.0°
 Efficiency 88 %
 Peak intensity 17.6 cd/lm
 LEDs/each optic 1
 Light colour/type White
 Required components:

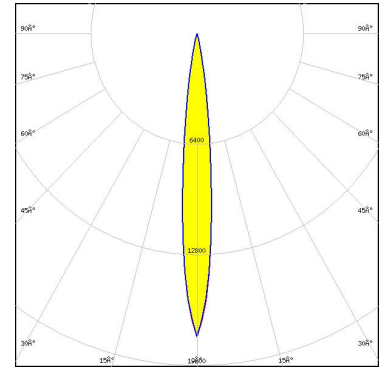

Light distribution files



LED XHP70.2
 FWHM / FWTM 20.0° / 36.0°
 Efficiency 84 %
 Peak intensity 5.9 cd/lm
 LEDs/each optic 1
 Light colour/type White
 Required components:

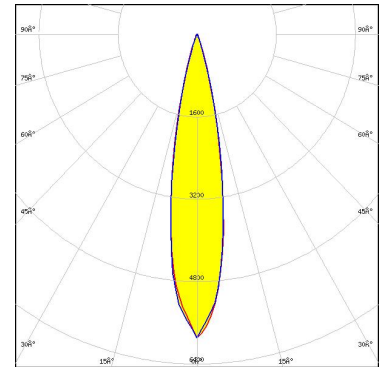

Light distribution files



LED XHP70.3 HD
 FWHM / FWTM 18.0° / 34.0°
 Efficiency 86 %
 Peak intensity 7 cd/lm
 LEDs/each optic 1
 Light colour/type White
 Required components:

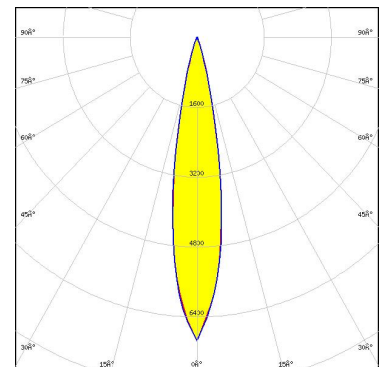

Light distribution files

OPTICAL RESULTS (SIMULATED):



LED XHP70.3 HI
 FWHM / FWTM 14.0° / 26.0°
 Efficiency 88 %
 Peak intensity 12.8 cd/lm
 LEDs/each optic 1
 Light colour/type White
 Required components:

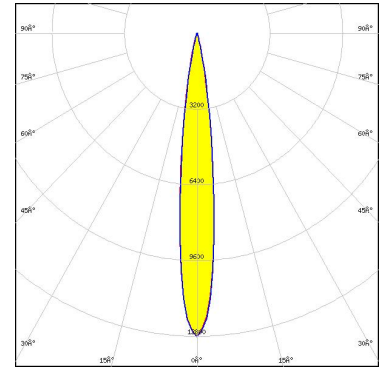

Light distribution files



LED XP-E2
 FWHM / FWTM 8.0° / 14.0°
 Efficiency 90 %
 Peak intensity 41.4 cd/lm
 LEDs/each optic 1
 Light colour/type White
 Required components:

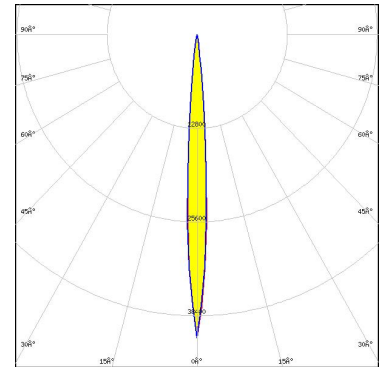

Light distribution files



LED XP-G4 HI
 FWHM / FWTM 6.0° / 12.0°
 Efficiency 87 %
 Peak intensity 58.3 cd/lm
 LEDs/each optic 1
 Light colour/type White
 Required components:

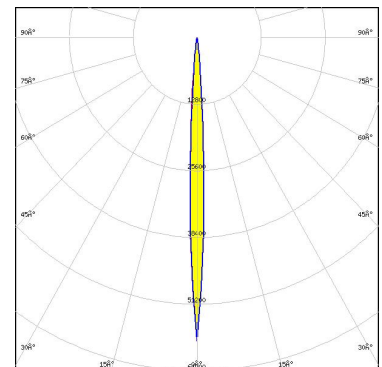

Light distribution files

OPTICAL RESULTS (SIMULATED):



LED XP-GR
 FWHM / FWTM 8.0° / 14.0°
 Efficiency 90 %
 Peak intensity 47.5 cd/lm
 LEDs/each optic 1
 Light colour/type White
 Required components:

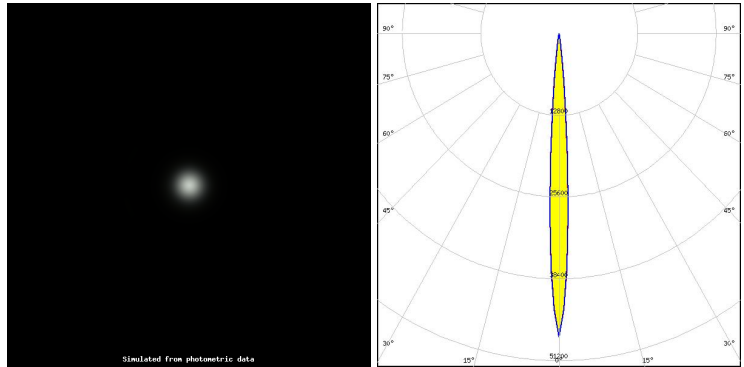

Light distribution files



LED XP-LR
 FWHM / FWTM 8.0° / 14.0°
 Efficiency 91 %
 Peak intensity 43.4 cd/lm
 LEDs/each optic 1
 Light colour/type White
 Required components:

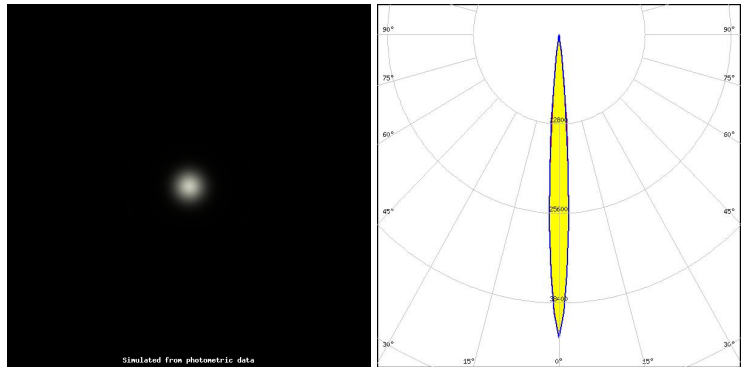

Light distribution files



LED LUXEON 3030 2D (Round LES)
 FWHM / FWTM 8.0° / 17.0°
 Efficiency 88 %
 Peak intensity 30.9 cd/lm
 LEDs/each optic 1
 Light colour/type White
 Required components:

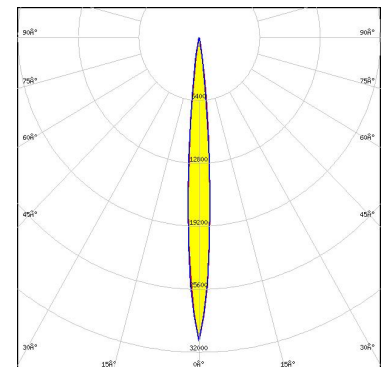

Light distribution files

OPTICAL RESULTS (SIMULATED):



LED LUXEON 5050 Round LES
FWHM / FWTM 13.0° / 24.0°
Efficiency 91 %
Peak intensity 15 cd/lm
LEDs/each optic 1
Light colour/type White
Required components:

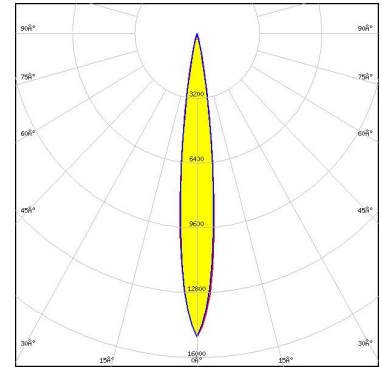

Light distribution files



LED LUXEON 5258
FWHM / FWTM 11.0° / 22.0°
Efficiency 89 %
Peak intensity 17.8 cd/lm
LEDs/each optic 1
Light colour/type White
Required components:

Light distribution files



LED LUXEON 7070
FWHM / FWTM 18.0° / 34.0°
Efficiency 86 %
Peak intensity 7.1 cd/lm
LEDs/each optic 1
Light colour/type White
Required components:

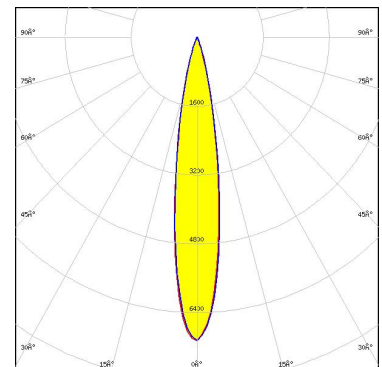

Light distribution files

OPTICAL RESULTS (SIMULATED):



LED LUXEON HL4Z
 FWHM / FWTM 8.0° / 14.0°
 Efficiency 89 %
 Peak intensity 42.7 cd/lm
 LEDs/each optic 1
 Light colour/type White
 Required components:

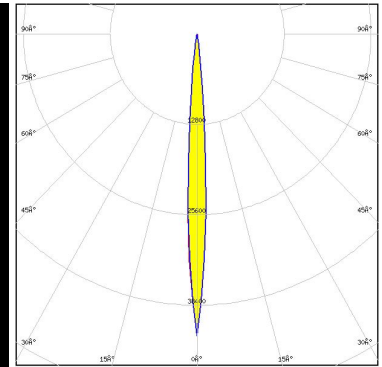
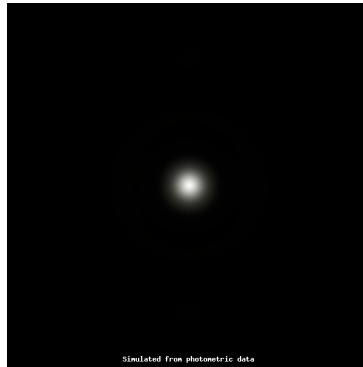

Light distribution files



LED SFT-40-WCS
 FWHM / FWTM 8.0° / 16.0°
 Efficiency 92 %
 Peak intensity 39.7 cd/lm
 LEDs/each optic 1
 Light colour/type White
 Required components:

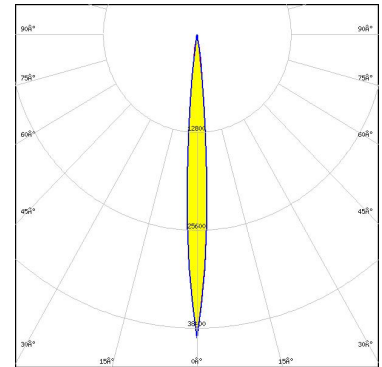

Light distribution files



LED SST-12 Gen1
 FWHM / FWTM 8.0° / 14.0°
 Efficiency 90 %
 Peak intensity 43.6 cd/lm
 LEDs/each optic 1
 Light colour/type White
 Required components:

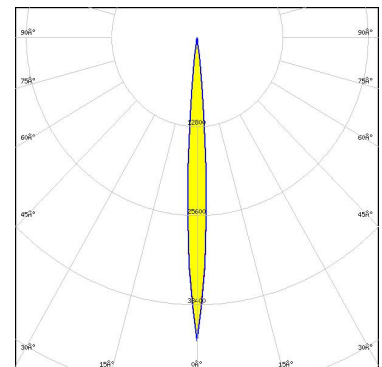

Light distribution files

OPTICAL RESULTS (SIMULATED):



LED SST-12 Gen2
FWHM / FWTM 8.0° / 14.0°
Efficiency 88 %
Peak intensity 40.3 cd/lm
LEDs/each optic 1
Light colour/type White
Required components:

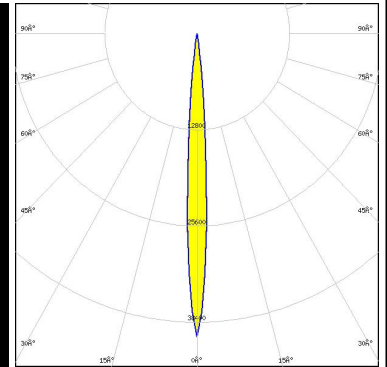
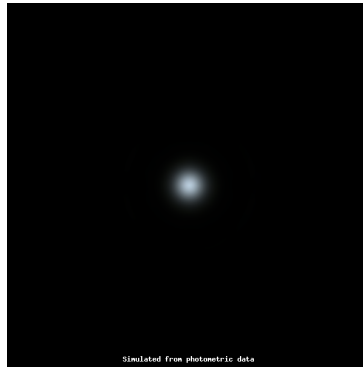

Light distribution files



LED SST-20 Gen1
FWHM / FWTM 8.0° / 16.0°
Efficiency 88 %
Peak intensity 34.3 cd/lm
LEDs/each optic 1
Light colour/type White
Required components:

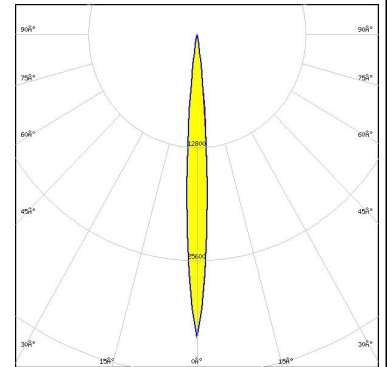

Light distribution files



LED SST-20 Gen2
FWHM / FWTM 8.0° / 16.0°
Efficiency 88 %
Peak intensity 35 cd/lm
LEDs/each optic 1
Light colour/type White
Required components:

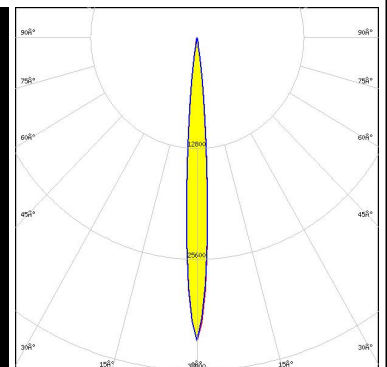
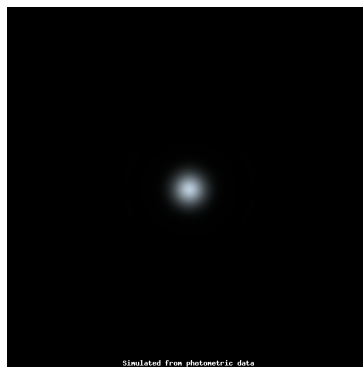

Light distribution files

OPTICAL RESULTS (SIMULATED):



LED SST-25-W
FWHM / FWTM 8.0° / 16.0°
Efficiency 89 %
Peak intensity 31.2 cd/lm
LEDs/each optic 1
Light colour/type White
Required components:

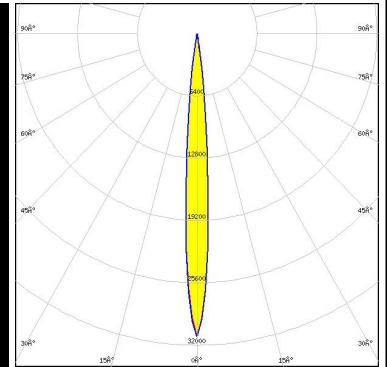
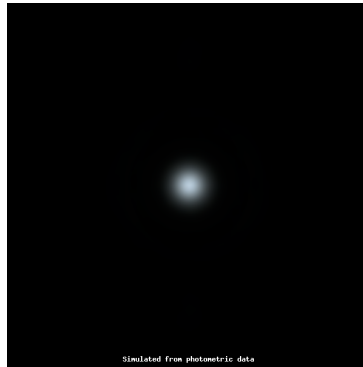

Light distribution files



LED SST-40
FWHM / FWTM 10.0° / 21.0°
Efficiency 90 %
Peak intensity 19.9 cd/lm
LEDs/each optic 1
Light colour/type White
Required components:

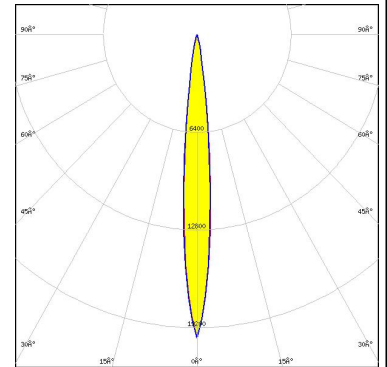

Light distribution files



LED NF2x757G
FWHM / FWTM 8.0° / 18.0°
Efficiency 91 %
Peak intensity 30.1 cd/lm
LEDs/each optic 1
Light colour/type White
Required components:

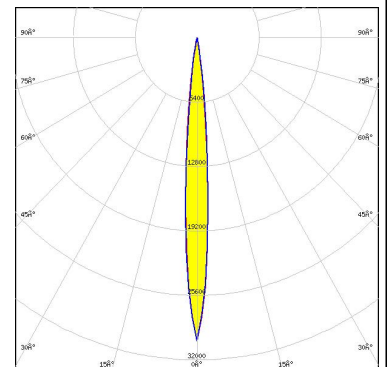

Light distribution files

OPTICAL RESULTS (SIMULATED):

OSRAM
Opto Semiconductors

LED OSCONIQ P 7070
FWHM / FWTM 14.0° / 23.0°
Efficiency 87 %
Peak intensity 13.5 cd/lm
LEDs/each optic 1
Light colour/type White
Required components:

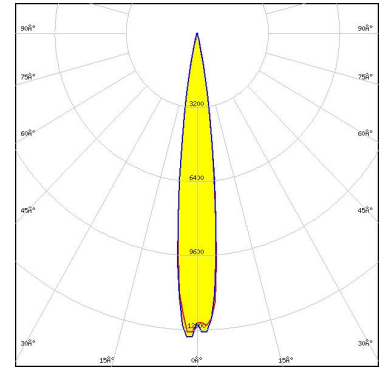

Light distribution files

OSRAM
Opto Semiconductors

LED OSLOM Black Flat (LUW HWQP)
FWHM / FWTM 8.0° / 14.0°
Efficiency 88 %
Peak intensity 45.2 cd/lm
LEDs/each optic 1
Light colour/type White
Required components:

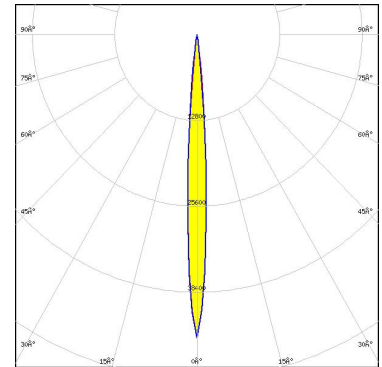

Light distribution files

OSRAM
Opto Semiconductors

LED OSLOM Black Flat S (KW HHL532.TK)
FWHM / FWTM 8.0° / 14.0°
Efficiency 88 %
Peak intensity 44.5 cd/lm
LEDs/each optic 1
Light colour/type White
Required components:

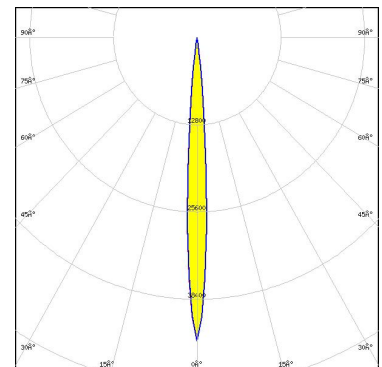

Light distribution files

OPTICAL RESULTS (SIMULATED):

OSRAM
Opto Semiconductors

LED OSLON Black Flat S (KW2 HIL532.TK)
FWHM / FWTM 8.0° / 16.0°
Efficiency 88 %
Peak intensity 34.2 cd/lm
LEDs/each optic 1
Light colour/type White
Required components:

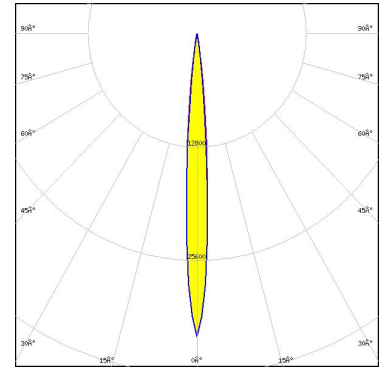

Light distribution files

OSRAM
Opto Semiconductors

LED OSLON Compact PL (KW2 CFLNM2.TK)
FWHM / FWTM 8.0° / 16.0°
Efficiency 89 %
Peak intensity 37.2 cd/lm
LEDs/each optic 1
Light colour/type White
Required components:

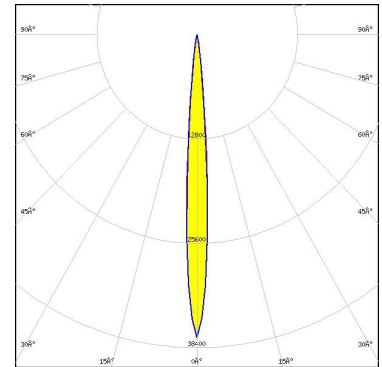

Light distribution files

OSRAM
Opto Semiconductors

LED OSLON Square CSSRM2/CSSRM3
FWHM / FWTM 7.9° / 16.0°
Efficiency 89 %
Peak intensity 36.5 cd/lm
LEDs/each optic 1
Light colour/type White
Required components:

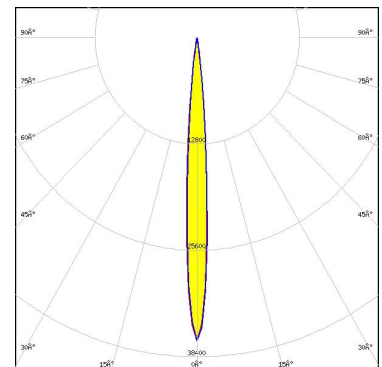

Light distribution files

OPTICAL RESULTS (SIMULATED):

OSRAM
Opto Semiconductors

LED OSLON Square Flat
 FWHM / FWTM 12.0° / 25.0°
 Efficiency 87 %
 Peak intensity 13.8 cd/lm
 LEDs/each optic 1
 Light colour/type White
 Required components:

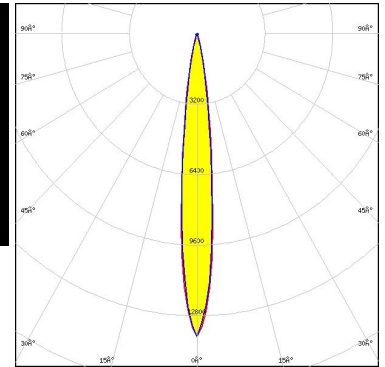
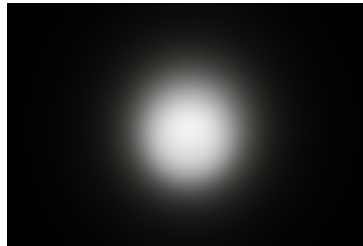

Light distribution files

OSRAM
Opto Semiconductors

LED OSTAR Stage (S2WN)
 FWHM / FWTM 9.0° / 18.0°
 Efficiency 92 %
 Peak intensity 29.6 cd/lm
 LEDs/each optic 1
 Light colour/type RGBW
 Required components:

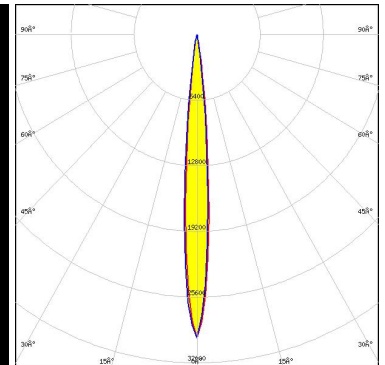
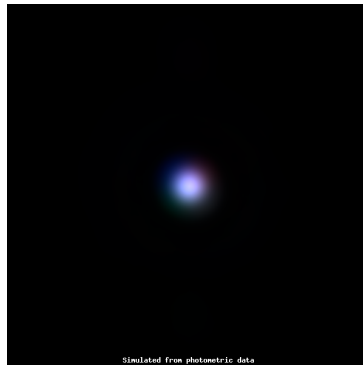

Light distribution files

OSRAM
Opto Semiconductors

LED OSTAR Stage (S2WP)
 FWHM / FWTM 12.0° / 21.0°
 Efficiency 93 %
 Peak intensity 20 cd/lm
 LEDs/each optic 1
 Light colour/type RGBW
 Required components:

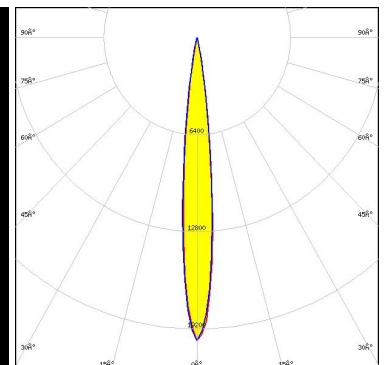
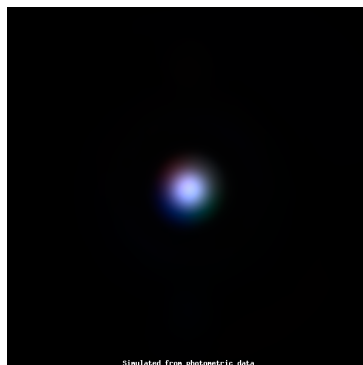

Light distribution files

OPTICAL RESULTS (SIMULATED):

OSRAM
Opto Semiconductors

LED SFH 4715AS
FWHM / FWTM 8.0° / 16.0°
Efficiency 89 %
LEDs/each optic 1
Light colour/type IR
Required components:

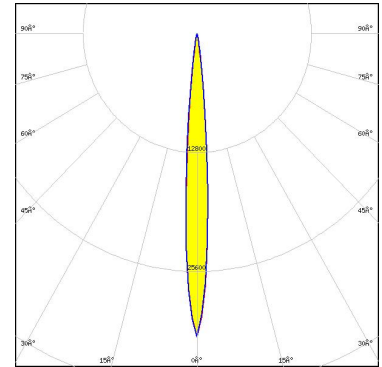

Light distribution files

OSRAM
Opto Semiconductors

LED SFH 4716AS
FWHM / FWTM 8.0° / 15.0°
Efficiency 88 %
LEDs/each optic 1
Light colour/type IR
Required components:

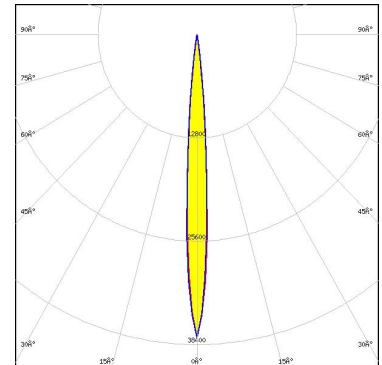

Light distribution files

OSRAM
Opto Semiconductors

LED SFH 4717AS
FWHM / FWTM 10.0° / 19.0°
Efficiency 87 %
LEDs/each optic 1
Light colour/type IR
Required components:

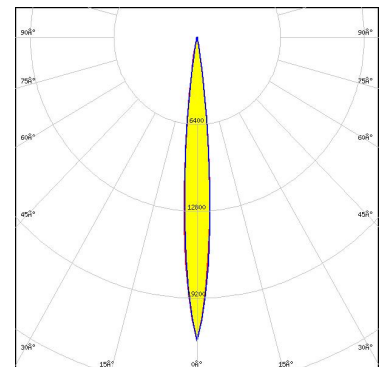
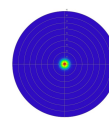
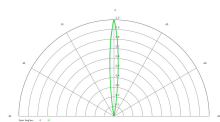

Light distribution files

OPTICAL RESULTS (SIMULATED):

OSRAM
Opto Semiconductors

LED SFH 4770S
 FWHM / FWTM 8.1° / 16.6°
 Efficiency 91 %
 Peak intensity 3.4 cd/lm
 LEDs/each optic 1
 Light colour/type IR
 Required components:

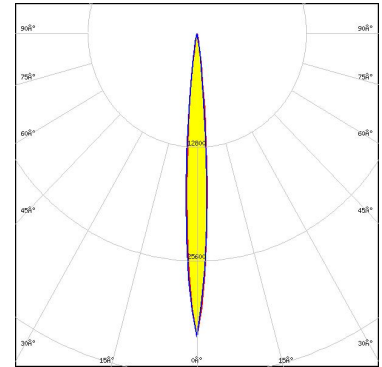

Light distribution files

SEOL
SEOUL SEMICONDUCTOR

LED Z8Y22P
 FWHM / FWTM 6.0°
 Efficiency 89 %
 Peak intensity 43.7 cd/lm
 LEDs/each optic 1
 Light colour/type White
 Required components:

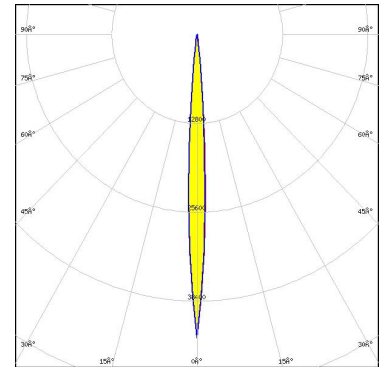

Light distribution files

SEOL
SEOUL SEMICONDUCTOR

LED Z8Y50P
 FWHM / FWTM 16.0° / 30.0°
 Efficiency 84 %
 Peak intensity 9.3 cd/lm
 LEDs/each optic 1
 Light colour/type White
 Required components:

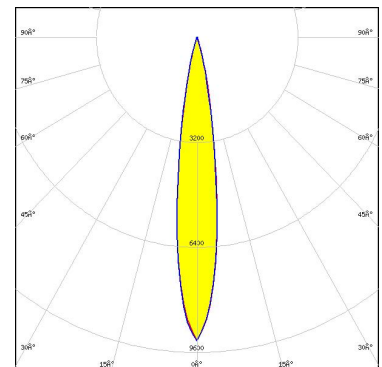

Light distribution files

OPTICAL RESULTS (SIMULATED):

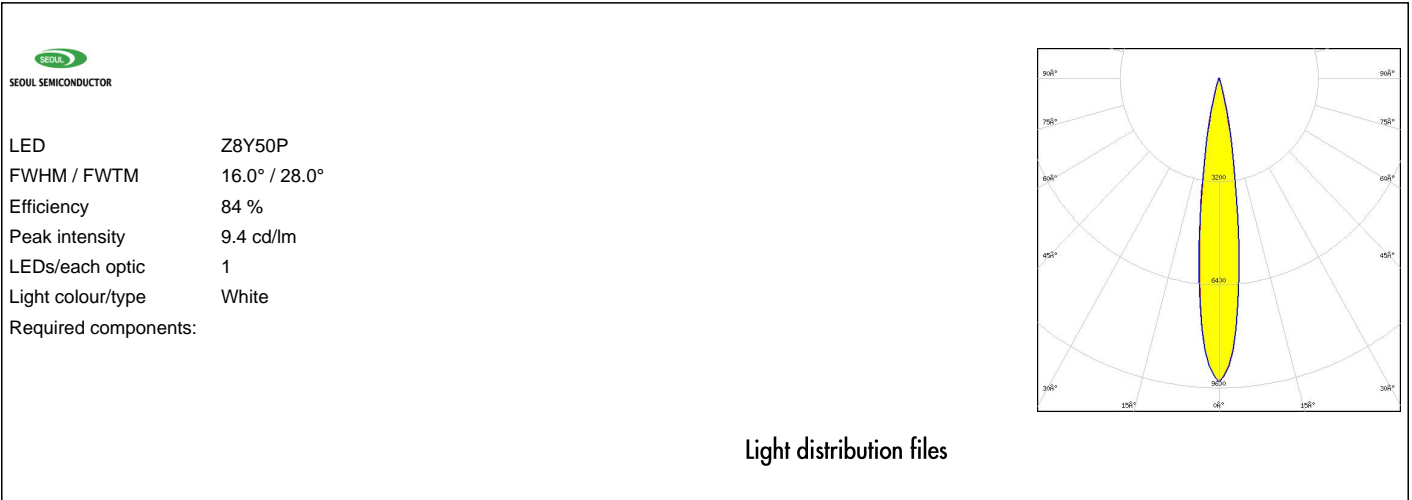

GENERAL INFORMATION:

NOTE: The typical beam angle will be changed by different color, chip size and chip position tolerance. The typical total beam angle is the full angle measured where the luminous intensity is half of the peak value.

MATERIALS:

As part of our continuous research and improvement processes, and to ensure the best possible quality and availability of our products, LEDiL reserves the right to change material grades without notice.

PRODUCT DATA USER AGREEMENT AND DISCLAIMER:

The measured data in the provided downloadable LEDiL Product Datasheets and Mechanical 2D-Drawings is rounded and provided as reference for planning. LEDiL Oy's optical specifications have been verified by conducting performance testing of the products in accordance with the company's quality system. The reported data are averaged results of multiple measurements with typical variation. LEDiL Oy reserves the right to without prior notification make changes and improvements to its products.

LEDiL Oy assumes neither warranty, nor guarantee nor any other liability of any kind for the contents and correctness of the provided data. The provided data has been generated with highest diligence but the provided data may in reality not represent the complete possible variation range of all intrinsic parameters. Therefore, in certain cases a deviation from the provided data could occur.

LEDiL Oy reserves the right to undertake technical changes of its products without further notification which could lead to changes in the provided data. LEDiL Oy assumes no liability of any kind for the possible deviation from any provided data or any other damage resulting from the usage of the provided data.

The user agrees to this disclaimer and user agreement with the download or usage of the provided files.

LEDiL Oy

Joensuunkatu 7
FI-24100 SALO
Finland

LEDiL Inc.

228 West Page Street
Suite D
Sycamore IL 60178
USA

Ledil Optics Technology (Shenzhen) Co., Ltd.

405 , Block B
Casic Motor Building
Shenzhen 518057
P.R.CHINA

Local sales and technical support

[www.ledil.com/
where_to_buy](http://www.ledil.com/where_to_buy)

Shipping locations

Poznan, Poland
Hong Kong, China

Distribution Partners

[www.ledil.com/
where_to_buy](http://www.ledil.com/where_to_buy)