

IRIS

~5° real spot beam optimized for CREE XP-E.
Assembly with holder and installation tape.

SPECIFICATION:

Dimensions	Ø 38.0
Height	27.1 mm
Fastening	glue, tape, pin, screw
ROHS compliant	yes ⓘ



LEDiL

MATERIALS:

Component	Type	Material	Colour	Finish	Length (mm)
IRIS	Single lens	PMMA	clear		
IRIS-XP-HLD-TAPE	Assembly	PC	black		

ORDERING INFORMATION:

Component		Qty in box	MOQ	MPQ	Box weight (kg)
FCA12077_IRIS	Single lens	378	126	42	8.9
» Box size: 480 x 280 x 300 mm					

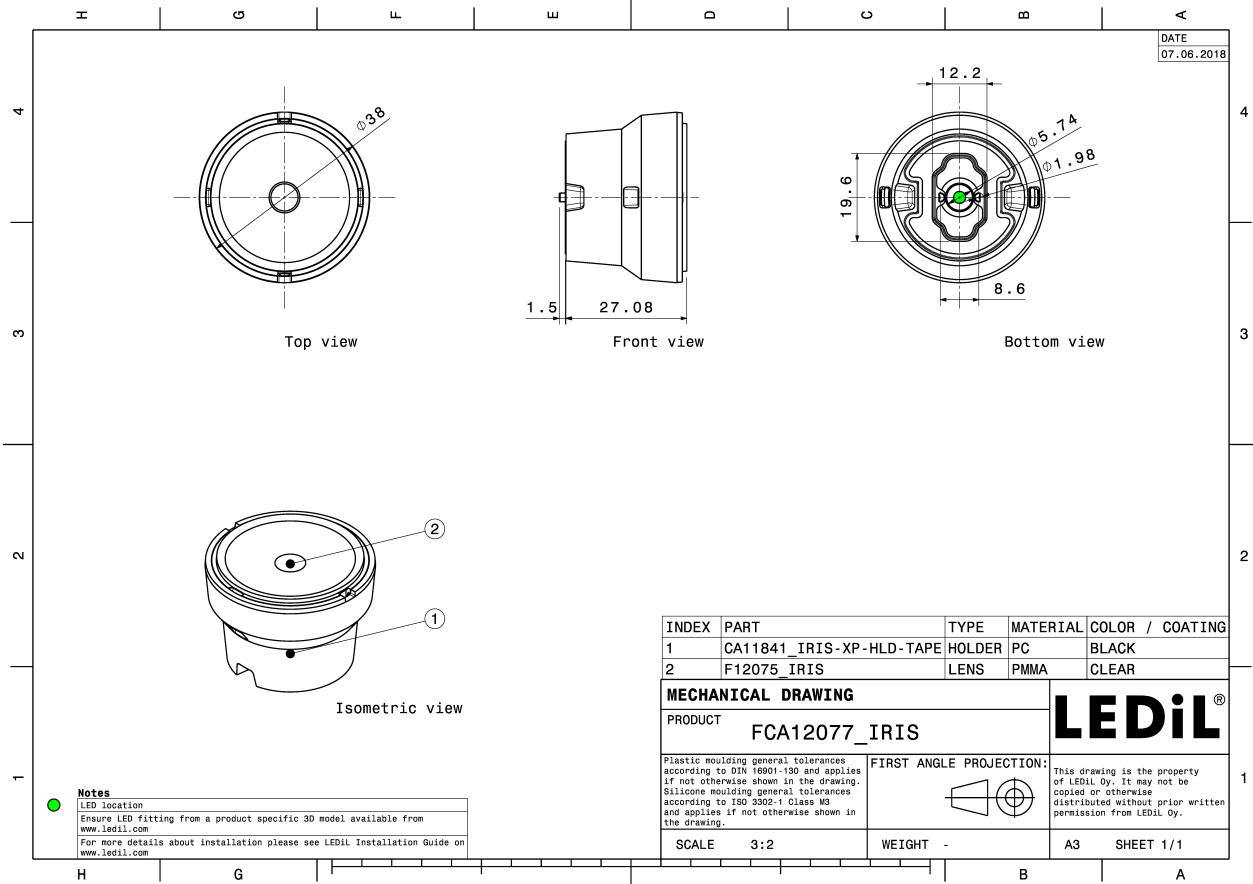

See also our general installation guide: www.ledil.com/installation_guide

OPTICAL RESULTS (MEASURED):



LED XHP35 HD
 FWHM / FWTM 10.0° / 23.0°
 Efficiency 89 %
 Peak intensity 18.6 cd/lm
 LEDs/each optic 1
 Light colour/type White
 Required components:

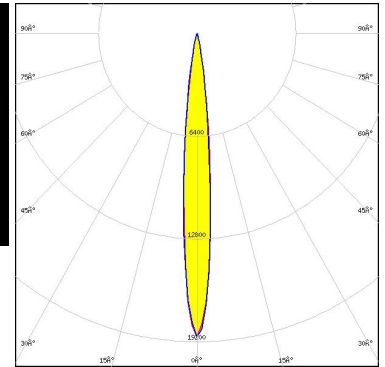

Light distribution files



LED XHP35 HI
 FWHM / FWTM 7.6° / 17.0°
 Efficiency 90 %
 Peak intensity 35.9 cd/lm
 LEDs/each optic 1
 Light colour/type White
 Required components:

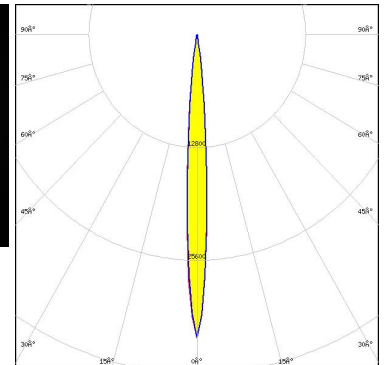

Light distribution files



LED XP-E
 FWHM / FWTM 4.0° / 9.0°
 Efficiency 93 %
 Peak intensity 87.4 cd/lm
 LEDs/each optic 1
 Light colour/type White
 Required components:

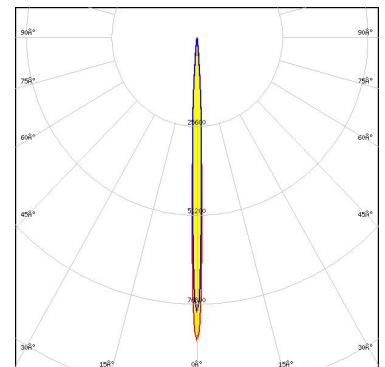

Light distribution files

OPTICAL RESULTS (MEASURED):



LED XP-E2
 FWHM / FWTM 5.0° / 9.0°
 Efficiency 93 %
 Peak intensity 103.9 cd/lm
 LEDs/each optic 1
 Light colour/type White
 Required components:

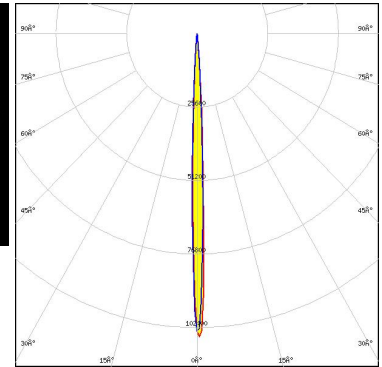

Light distribution files



LED XP-G
 FWHM / FWTM 6.0° / 14.0°
 Efficiency 94 %
 Peak intensity 46.4 cd/lm
 LEDs/each optic 1
 Light colour/type White
 Required components:

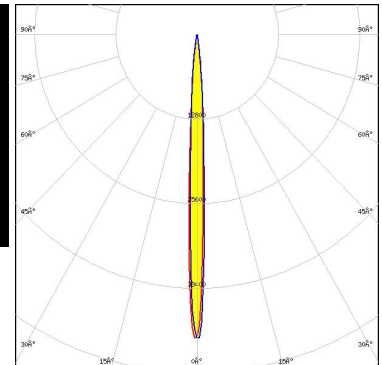
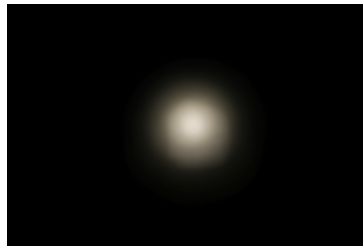

Light distribution files



LED XP-G2
 FWHM / FWTM 6.0° / 14.0°
 Efficiency 95 %
 Peak intensity 46 cd/lm
 LEDs/each optic 1
 Light colour/type White
 Required components:

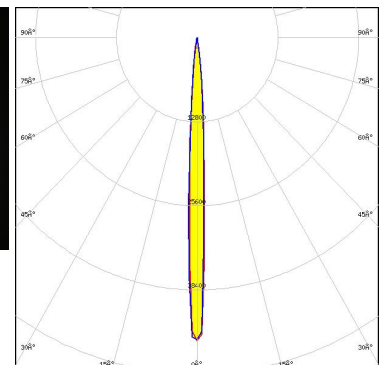

Light distribution files

OPTICAL RESULTS (MEASURED):



LED XP-P
 FWHM / FWMTM 3.0° / 8.0°
 Efficiency 96 %
 Peak intensity 152.7 cd/lm
 LEDs/each optic 1
 Light colour/type White
 Required components:

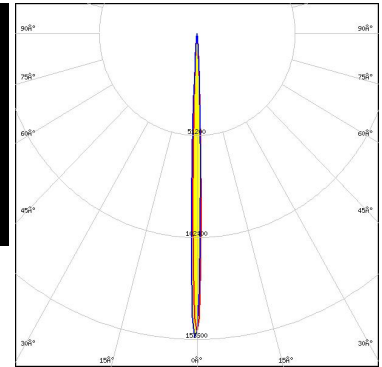
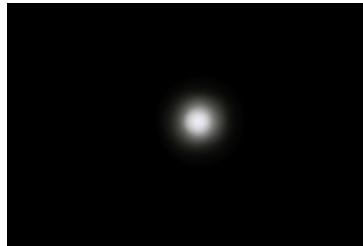

Light distribution files



LED XQ-E HI
 FWHM / FWMTM 3.9° / 9.0°
 Efficiency 88 %
 Peak intensity 123.3 cd/lm
 LEDs/each optic 1
 Light colour/type White
 Required components:

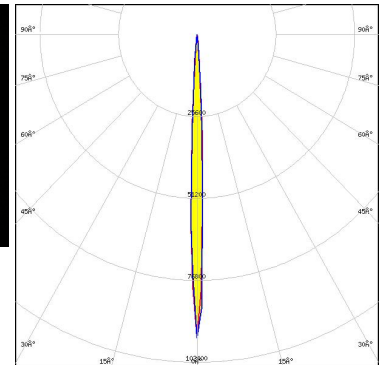

Light distribution files



LED XT-E
 FWHM / FWMTM 6.0° / 13.0°
 Efficiency 91 %
 Peak intensity 44 cd/lm
 LEDs/each optic 1
 Light colour/type White
 Required components:

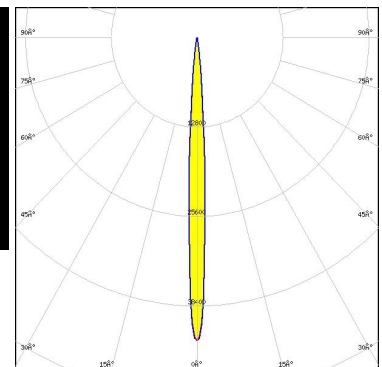
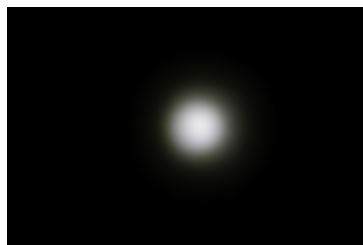

Light distribution files

OPTICAL RESULTS (MEASURED):



LED LUXEON Rebel
FWHM / FWTM 5.0° / 9.0°
Efficiency %
Peak intensity 75.6 cd/lm
LEDs/each optic 1
Light colour/type White
Required components:

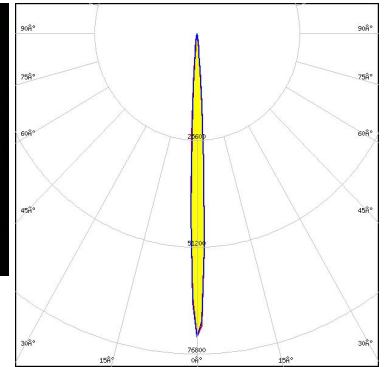
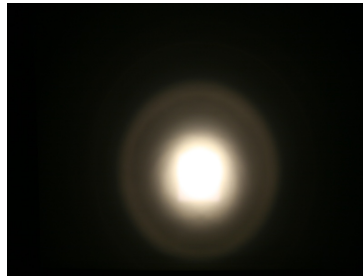

Light distribution files



LED LUXEON Rebel ES
FWHM / FWTM 7.0° / 14.0°
Efficiency 93 %
Peak intensity 38.5 cd/lm
LEDs/each optic 1
Light colour/type White
Required components:

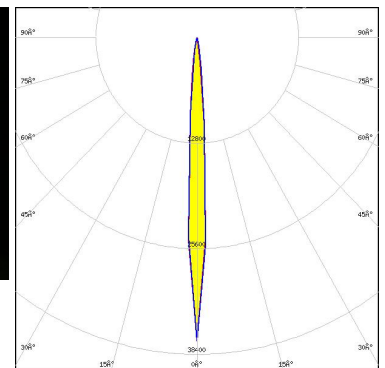

Light distribution files



LED LUXEON T
FWHM / FWTM 7.0° / 14.0°
Efficiency 94 %
Peak intensity 40.2 cd/lm
LEDs/each optic 1
Light colour/type White
Required components:

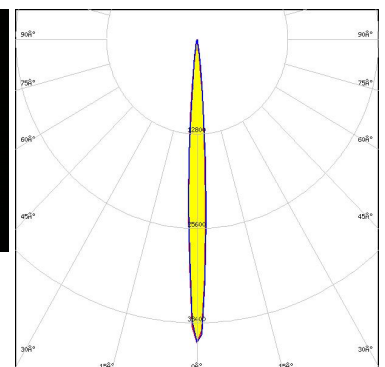
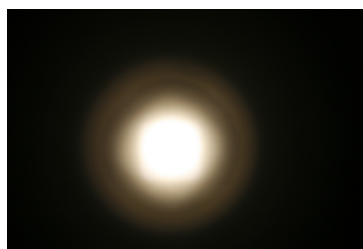

Light distribution files

OPTICAL RESULTS (MEASURED):



LED LUXEON TX
FWHM / FWTM 6.9° / 15.0°
Efficiency 89 %
Peak intensity 43.1 cd/lm
LEDs/each optic 1
Light colour/type White
Required components:

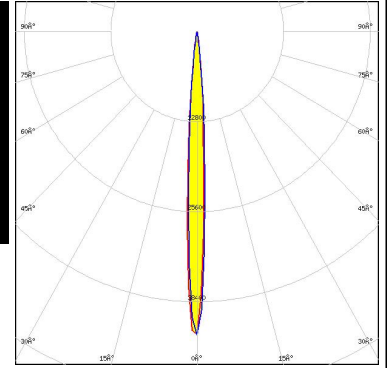
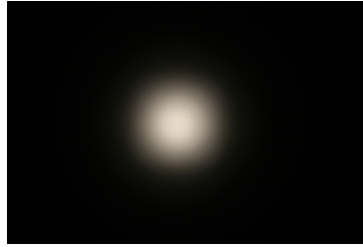

Light distribution files



LED LUXEON Z ES
FWHM / FWTM 4.0° / 9.0°
Efficiency 93 %
Peak intensity 94.1 cd/lm
LEDs/each optic 1
Light colour/type White
Required components:

Luminaire: LEDiL Oy FCA12077_IRIS (Z_ES)
 Lamps: 1 x Philips_Lumileds_Luxeon_Z_ES (LXZ-5070)
 84.6520lm@250mA, P=0.734W@SW, I=240 mA

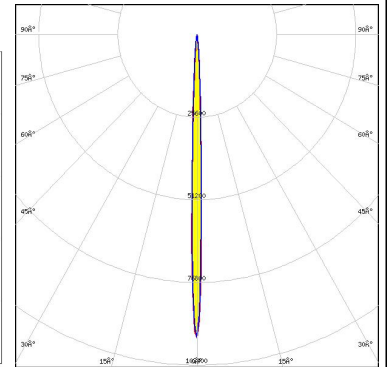
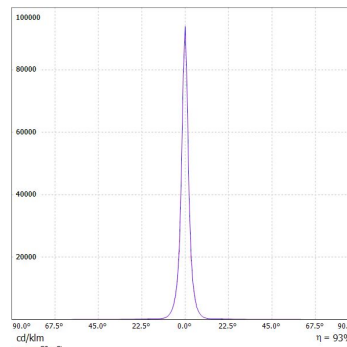

Light distribution files



LED NCSxx19A
FWHM / FWTM 5.0° / 11.0°
Efficiency %
LEDs/each optic 1
Light colour/type White
Required components:

Light distribution files

OPTICAL RESULTS (MEASURED):



LED NVSW219F
 FWHM / FWTM 7.0° / 16.0°
 Efficiency 94 %
 Peak intensity 35.7 cd/lm
 LEDs/each optic 1
 Light colour/type White
 Required components:

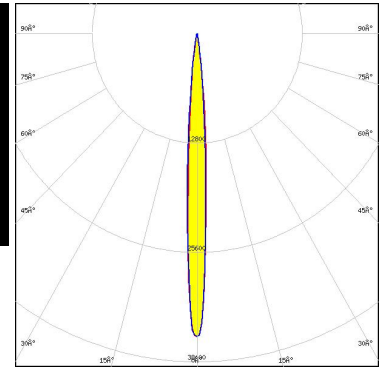
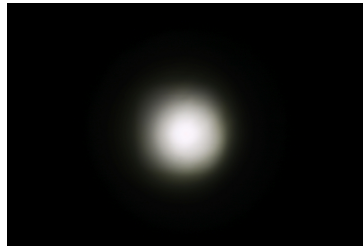

Light distribution files



LED NVSW3x9A
 FWHM / FWTM 8.0° / 18.0°
 Efficiency 89 %
 Peak intensity 26.3 cd/lm
 LEDs/each optic 1
 Light colour/type White
 Required components:

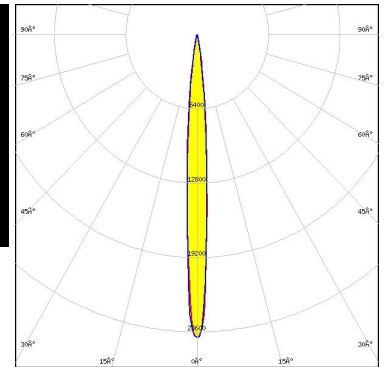

Light distribution files



LED NVSW719AC
 FWHM / FWTM 7.0° / 11.0°
 Efficiency 91 %
 Peak intensity 55.9 cd/lm
 LEDs/each optic 1
 Light colour/type White
 Required components:

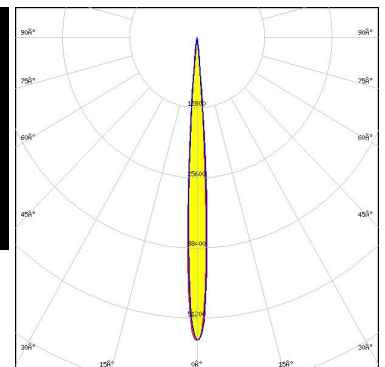

Light distribution files

OPTICAL RESULTS (MEASURED):



LED NVSxx19A
 FWHM / FWTM 6.0° / 14.0°
 Efficiency 93 %
 Peak intensity 38.7 cd/lm
 LEDs/each optic 1
 Light colour/type White
 Required components:

Light distribution files



LED NVSxx19B/NVSxx19C
 FWHM / FWTM 7.0° / 15.0°
 Efficiency 92 %
 Peak intensity 36.6 cd/lm
 LEDs/each optic 1
 Light colour/type White
 Required components:

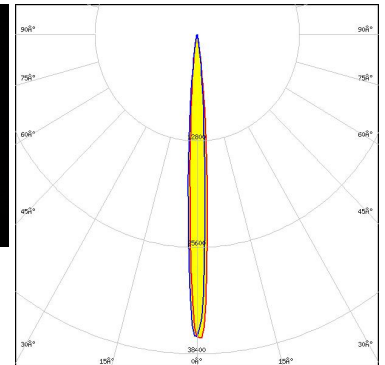

Light distribution files



LED NWSx229A
 FWHM / FWTM 10.0° / 21.0°
 Efficiency 91 %
 Peak intensity 18.6 cd/lm
 LEDs/each optic 1
 Light colour/type White
 Required components:

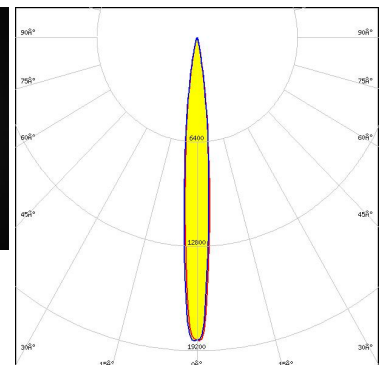

Light distribution files

OPTICAL RESULTS (MEASURED):

OSRAM
Opto Semiconductors

LED OSLON Square EC
 FWHM / FWTM 6.0° / 12.0°
 Efficiency 92 %
 Peak intensity 52 cd/lm
 LEDs/each optic 1
 Light colour/type White
 Required components:

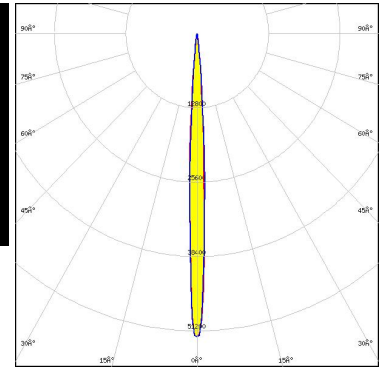

Light distribution files

OSRAM
Opto Semiconductors

LED OSLON SSL 150
 FWHM / FWTM 4.0° / 9.0°
 Efficiency 94 %
 Peak intensity 101 cd/lm
 LEDs/each optic 1
 Light colour/type White
 Required components:

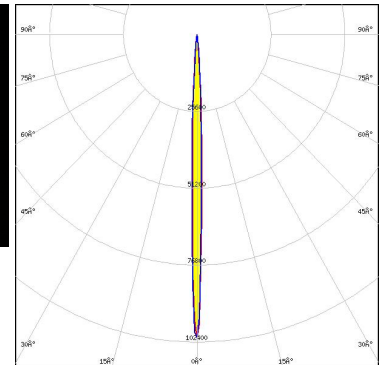

Light distribution files

OSRAM
Opto Semiconductors

LED OSLON SSL 80
 FWHM / FWTM 4.0° / 9.0°
 Efficiency 90 %
 Peak intensity 89 cd/lm
 LEDs/each optic 1
 Light colour/type White
 Required components:

Light distribution files

OPTICAL RESULTS (MEASURED):

SAMSUNG

LED LH351Z
FWHM / FWTM 7.0° / 15.0°
Efficiency 89 %
Peak intensity 48.1 cd/lm
LEDs/each optic 1
Light colour/type White
Required components:

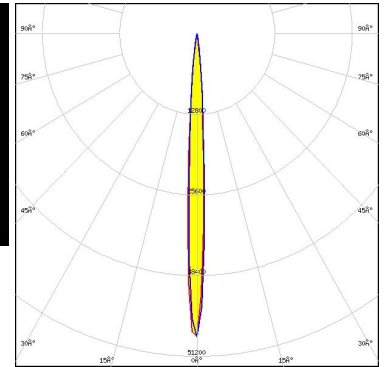

Light distribution files



SEOUL SEMICONDUCTOR

LED Z5M3
FWHM / FWTM 7.0° / 16.0°
Efficiency 92 %
Peak intensity 30 cd/lm
LEDs/each optic 1
Light colour/type White
Required components:

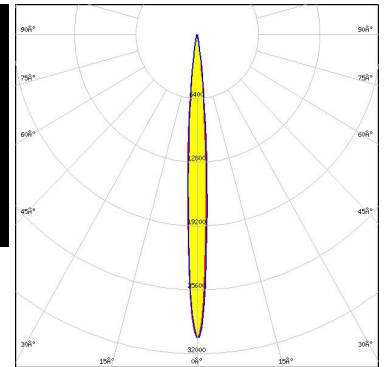
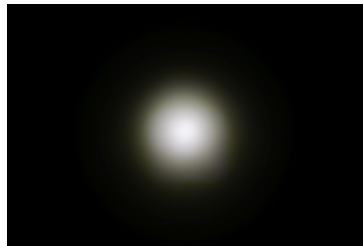

Light distribution files

OPTICAL RESULTS (SIMULATED):



LED XD16
FWHM / FWTM 6.0° / 14.0°
Efficiency 91 %
Peak intensity 47.9 cd/lm
LEDs/each optic 1
Light colour/type White
Required components:

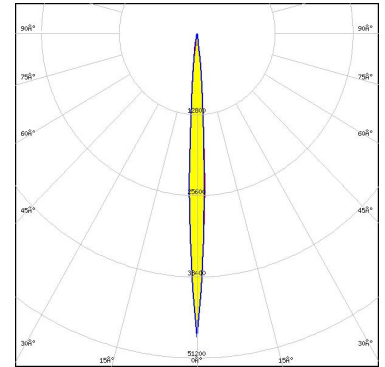

Light distribution files



LED XE-G
FWHM / FWTM 4.0° / 10.0°
Efficiency 91 %
Peak intensity 87.9 cd/lm
LEDs/each optic 1
Light colour/type White
Required components:

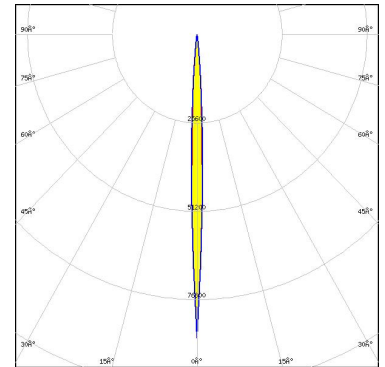

Light distribution files



LED XE-G
FWHM / FWTM 6.0° / 12.0°
Efficiency 93 %
Peak intensity 63.9 cd/lm
LEDs/each optic 1
Light colour/type Red
Required components:

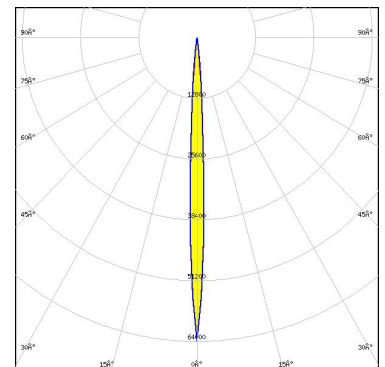

Light distribution files

OPTICAL RESULTS (SIMULATED):



LED XE-G
FWHM / FWTM 6.0° / 12.0°
Efficiency 92 %
Peak intensity 73.6 cd/lm
LEDs/each optic 1
Light colour/type Royal Blue
Required components:

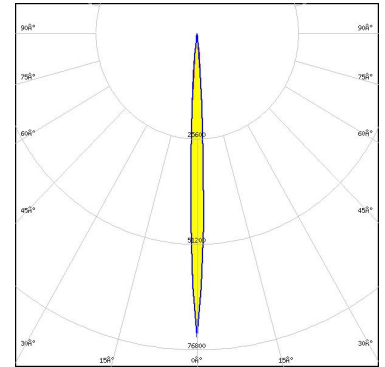

Light distribution files



LED XE-G
FWHM / FWTM 6.0° / 12.0°
Efficiency 92 %
Peak intensity 62.9 cd/lm
LEDs/each optic 1
Light colour/type Red
Required components:

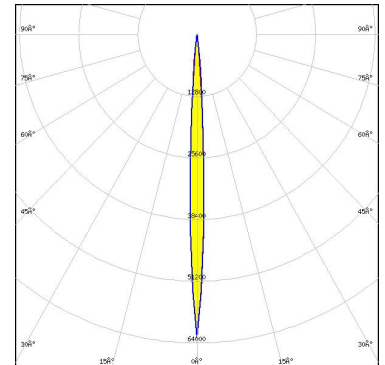

Light distribution files



LED XP-G2 HE
FWHM / FWTM 8.0° / 18.0°
Efficiency 92 %
Peak intensity 29.7 cd/lm
LEDs/each optic 1
Light colour/type White
Required components:

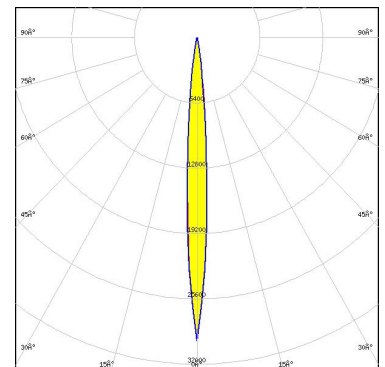

Light distribution files

OPTICAL RESULTS (SIMULATED):



LED XP-G3
 FWHM / FWTM 7.7° / 18.0°
 Efficiency 91 %
 Peak intensity 28.7 cd/m
 LEDs/each optic 1
 Light colour/type White
 Required components:

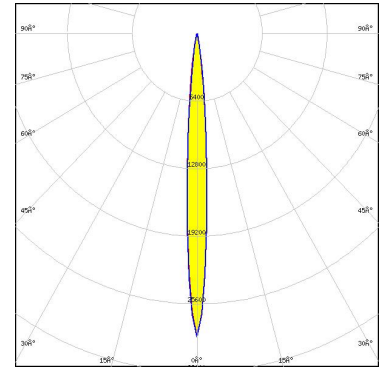

Light distribution files



LED XP-L HD
 FWHM / FWTM 8.6° / 19.0°
 Efficiency 93 %
 Peak intensity 25.3 cd/m
 LEDs/each optic 1
 Light colour/type White
 Required components:

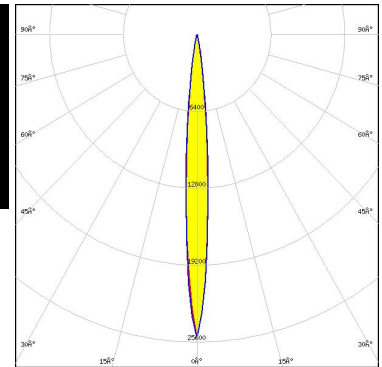

Light distribution files



LED XP-P
 FWHM / FWTM 4.0° / 10.0°
 Efficiency 93 %
 Peak intensity 88.5 cd/m
 LEDs/each optic 1
 Light colour/type White
 Required components:

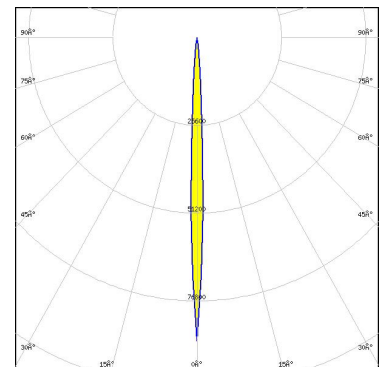

Light distribution files

OPTICAL RESULTS (SIMULATED):



LED XQ-E HD
 FWHM / FWTM 5.0° / 11.5°
 Efficiency 93 %
 Peak intensity 80 cd/m
 LEDs/each optic 1
 Light colour/type White
 Required components:

Light distribution files



LED XQ-E HD
 FWHM / FWTM 5.3° / 11.0°
 Efficiency 94 %
 Peak intensity 77.8 cd/m
 LEDs/each optic 1
 Light colour/type White
 Required components:

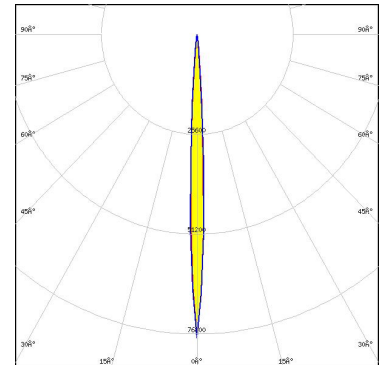

Light distribution files



LED LUXEON H50-2
 FWHM / FWTM 7.0° / 15.0°
 Efficiency 94 %
 Peak intensity 38.6 cd/m
 LEDs/each optic 1
 Light colour/type White
 Required components:

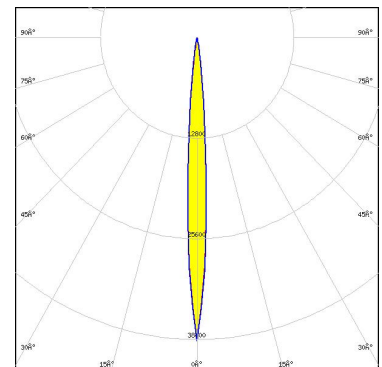

Light distribution files

OPTICAL RESULTS (SIMULATED):



LED LUXEON HL2Z
 FWHM / FWTM 6.0° / 14.0°
 Efficiency 93 %
 Peak intensity 54.9 cd/lm
 LEDs/each optic 1
 Light colour/type White
 Required components:

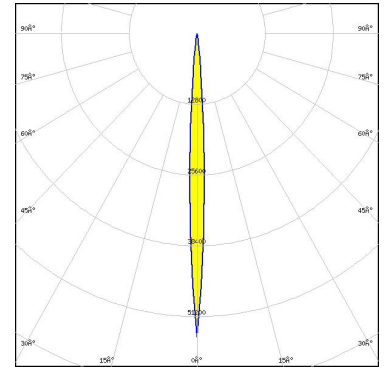

Light distribution files



LED LUXEON Rubix
 FWHM / FWTM 4.0° / 8.0°
 Efficiency 92 %
 Peak intensity 130.9 cd/lm
 LEDs/each optic 1
 Light colour/type White
 Required components:

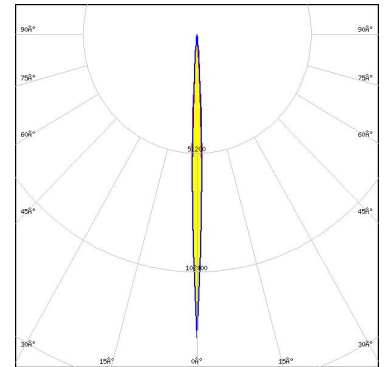

Light distribution files



LED LUXEON SunPlus 20 Line (150 deg)
 FWHM / FWTM 6.0° / 14.0°
 Efficiency 90 %
 Peak intensity 42.7 cd/lm
 LEDs/each optic 1
 Light colour/type White
 Required components:

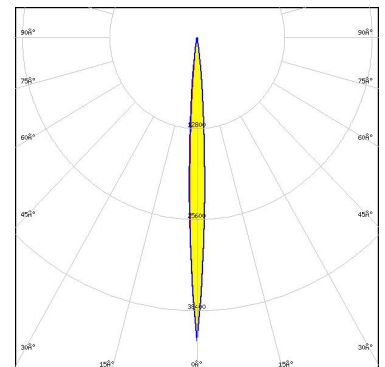

Light distribution files

OPTICAL RESULTS (SIMULATED):



LED LUXEON SunPlus 35 Line
 FWHM / FWTM 6.0° / 15.0°
 Efficiency 94 %
 Peak intensity 49.9 cd/m
 LEDs/each optic 1
 Light colour/type Blue
 Required components:

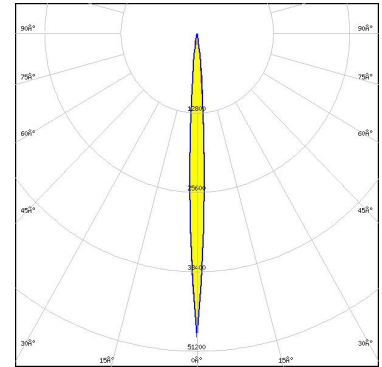

Light distribution files



LED SST-10-B130
 FWHM / FWTM 6.0° / 13.0°
 Efficiency 94 %
 LEDs/each optic 1
 Light colour/type IR
 Required components:

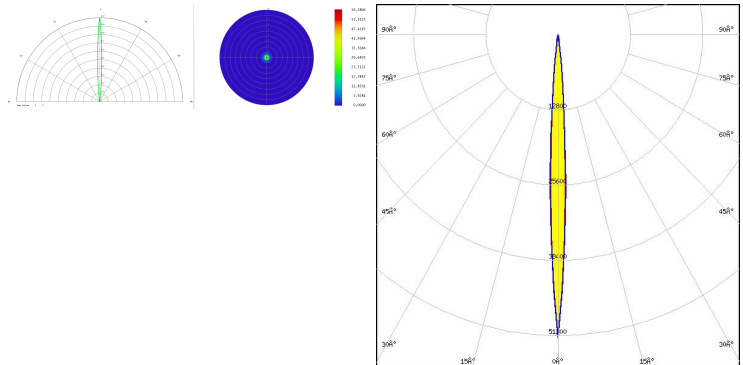

Light distribution files



LED SST-20 Gen1
 FWHM / FWTM 6.0° / 14.0°
 Efficiency 93 %
 Peak intensity 48.4 cd/m
 LEDs/each optic 1
 Light colour/type White
 Required components:

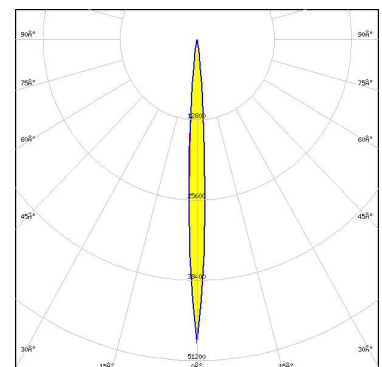

Light distribution files

OPTICAL RESULTS (SIMULATED):

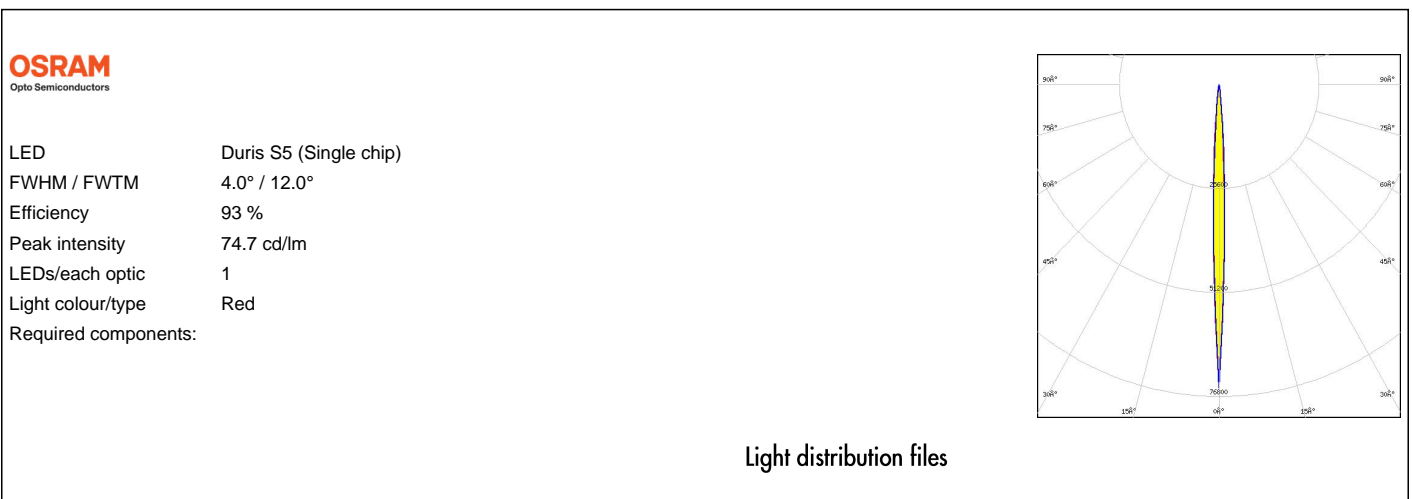
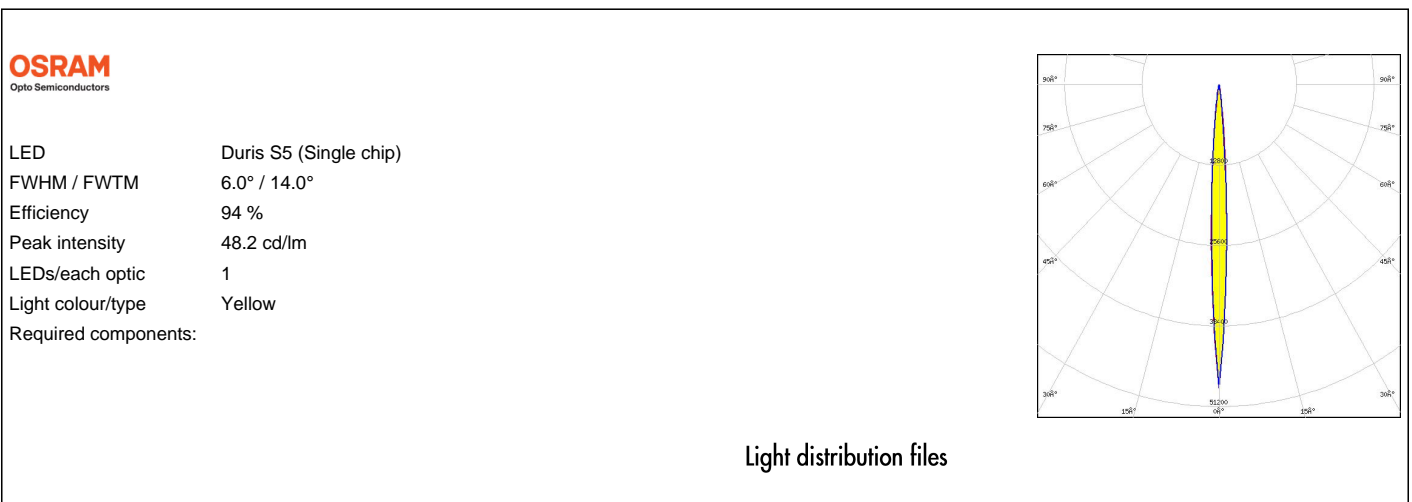
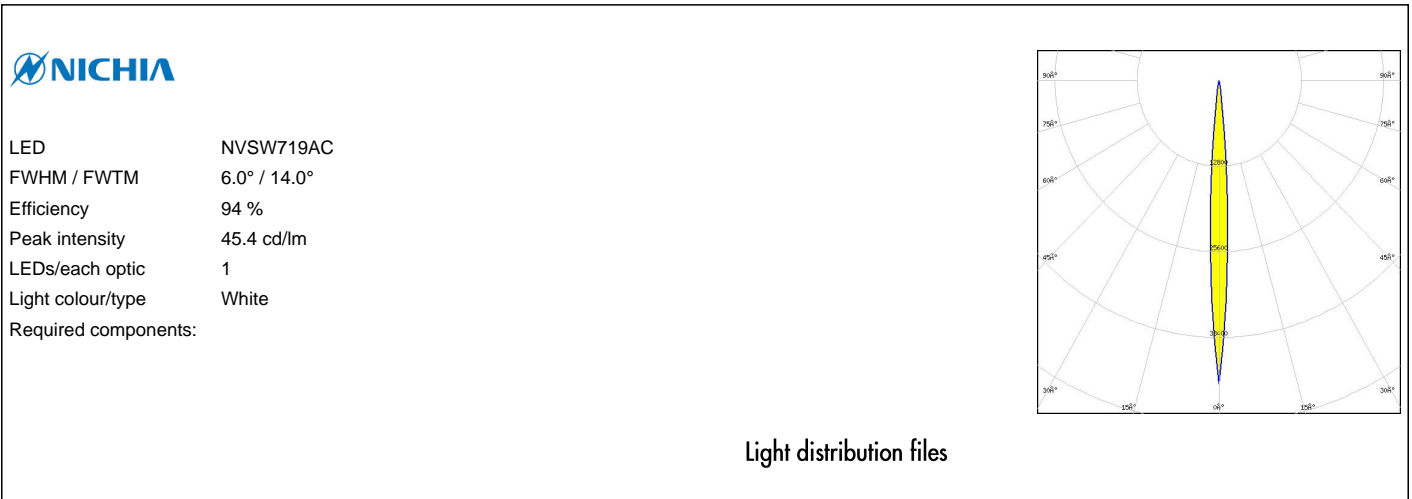

OPTICAL RESULTS (SIMULATED):

OSRAM
Opto Semiconductors

LED Duris S5 (Single chip)
 FWHM / FWTM 4.0° / 12.0°
 Efficiency 93 %
 Peak intensity 72.5 cd/lm
 LEDs/each optic 1
 Light colour/type Green
 Required components:

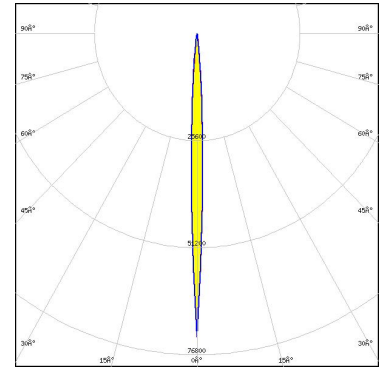

Light distribution files

OSRAM
Opto Semiconductors

LED OSCONIQ P 3737 (2W version)
 FWHM / FWTM 6.0° / 14.0°
 Efficiency 94 %
 Peak intensity 46.2 cd/lm
 LEDs/each optic 1
 Light colour/type White
 Required components:

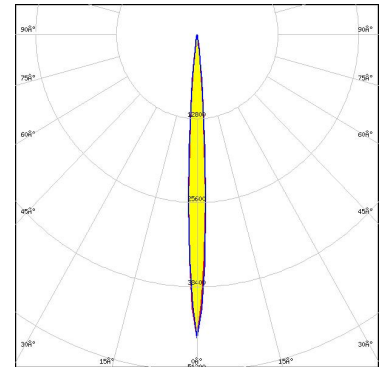

Light distribution files

OSRAM
Opto Semiconductors

LED OSLOM Black Flat (LUW HWQP)
 FWHM / FWTM 4.2° / 10.0°
 Efficiency 94 %
 Peak intensity 92 cd/lm
 LEDs/each optic 1
 Light colour/type White
 Required components:

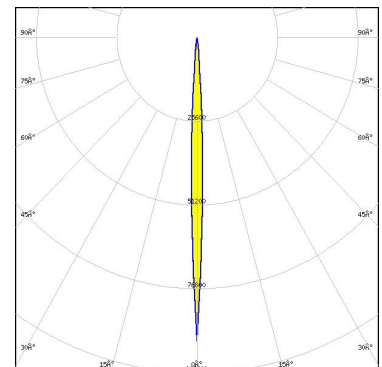

Light distribution files

OPTICAL RESULTS (SIMULATED):

OSRAM
Opto Semiconductors

LED OSLON Black Flat (LUW HWQP)
 FWHM / FWTM 6.0° / 14.0°
 Efficiency 94 %
 Peak intensity 48.9 cd/lm
 LEDs/each optic 1
 Light colour/type White
 Required components:

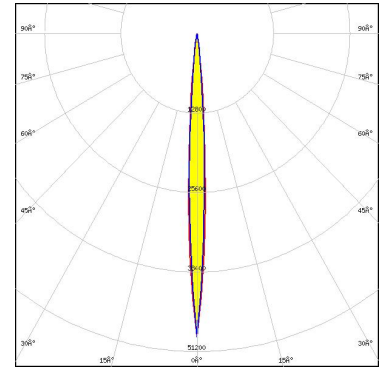

Light distribution files

OSRAM
Opto Semiconductors

LED OSLON Square CSSRM2/CSSRM3
 FWHM / FWTM 6.4° / 14.0°
 Efficiency 94 %
 Peak intensity 48.3 cd/lm
 LEDs/each optic 1
 Light colour/type White
 Required components:

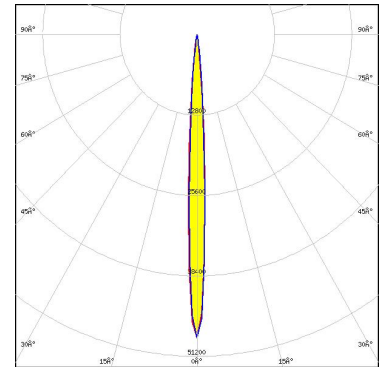

Light distribution files

OSRAM
Opto Semiconductors

LED OSTAR Projection Compact (KW.CSLNM1.TG)
 FWHM / FWTM 4.0° / 10.0°
 Efficiency 93 %
 Peak intensity 94.8 cd/lm
 LEDs/each optic 1
 Light colour/type White
 Required components:

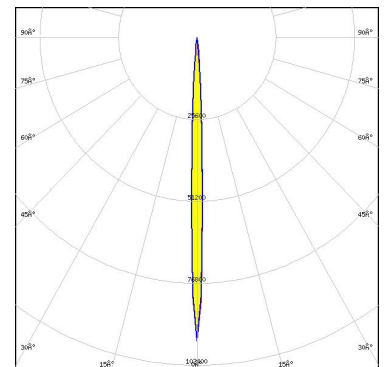

Light distribution files

OPTICAL RESULTS (SIMULATED):

OSRAM
Opto Semiconductors

LED OSTAR Projection Compact (KW.CSLNM1.TG)
FWHM / FWTM 6.0° / 12.0°
Efficiency 94 %
Peak intensity 76.4 cd/m
LEDs/each optic 1
Light colour/type White
Required components:

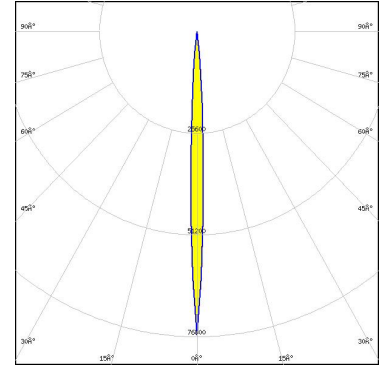

Light distribution files

OSRAM
Opto Semiconductors

LED SFH 4716AS
FWHM / FWTM 6.0° / 12.0°
Efficiency 94 %
LEDs/each optic 1
Light colour/type IR
Required components:

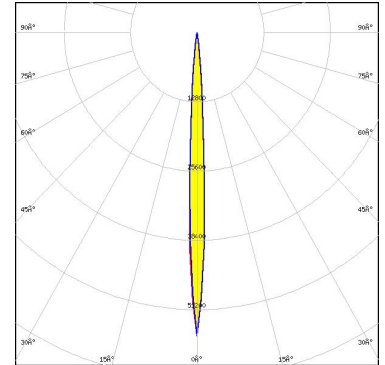

Light distribution files

SAMSUNG

LED LH351C
FWHM / FWTM 8.0° / 18.0°
Efficiency 93 %
Peak intensity 31.2 cd/m
LEDs/each optic 1
Light colour/type White
Required components:

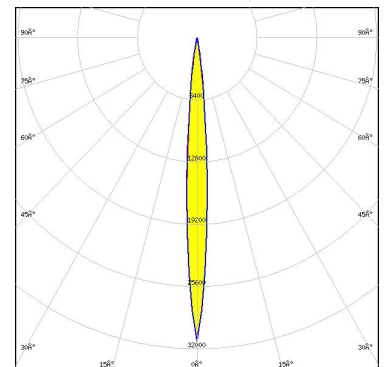

Light distribution files

OPTICAL RESULTS (SIMULATED):

SAMSUNG

LED LH351D
FWHM / FWTM 9.3° / 21.0°
Efficiency 90 %
Peak intensity 21 cd/lm
LEDs/each optic 1
Light colour/type White
Required components:

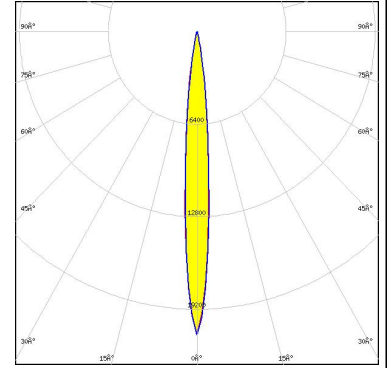

Light distribution files



LED Z8Y22P
FWHM / FWTM 8.0°
Efficiency 98 %
Peak intensity 29.9 cd/lm
LEDs/each optic 1
Light colour/type White
Required components:

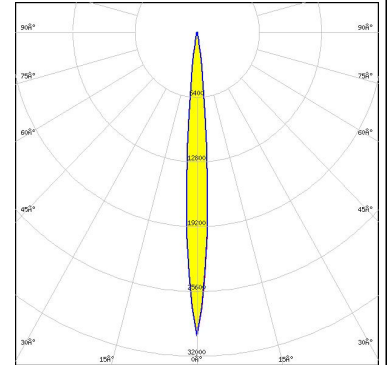

Light distribution files

GENERAL INFORMATION:

NOTE: The typical beam angle will be changed by different color, chip size and chip position tolerance. The typical total beam angle is the full angle measured where the luminous intensity is half of the peak value.

MATERIALS:

As part of our continuous research and improvement processes, and to ensure the best possible quality and availability of our products, LEDiL reserves the right to change material grades without notice.

PRODUCT DATA USER AGREEMENT AND DISCLAIMER:

The measured data in the provided downloadable LEDiL Product Datasheets and Mechanical 2D-Drawings is rounded and provided as reference for planning. LEDiL Oy's optical specifications have been verified by conducting performance testing of the products in accordance with the company's quality system. The reported data are averaged results of multiple measurements with typical variation. LEDiL Oy reserves the right to without prior notification make changes and improvements to its products.

LEDiL Oy assumes neither warranty, nor guarantee nor any other liability of any kind for the contents and correctness of the provided data. The provided data has been generated with highest diligence but the provided data may in reality not represent the complete possible variation range of all intrinsic parameters. Therefore, in certain cases a deviation from the provided data could occur.

LEDiL Oy reserves the right to undertake technical changes of its products without further notification which could lead to changes in the provided data. LEDiL Oy assumes no liability of any kind for the possible deviation from any provided data or any other damage resulting from the usage of the provided data.

The user agrees to this disclaimer and user agreement with the download or usage of the provided files.

LEDiL Oy

Joensuunkatu 7
FI-24240 SALO
Finland

LEDiL Inc.

228 West Page Street
Suite D
Sycamore IL 60178
USA

Ledil Optics Technology (Shenzhen) Co., Ltd.

405 , Block B
Casic Motor Building
Shenzhen 518057
P.R.CHINA

Local sales and technical support

[www.ledil.com/
where_to_buy](http://www.ledil.com/where_to_buy)

Shipping locations

Poznan, Poland
Hong Kong, China

Distribution Partners

[www.ledil.com/
where_to_buy](http://www.ledil.com/where_to_buy)