

## LINNEA-60-B-PMMA

~60° + 90° beam optimized for 0.5 mm metal sheet or profile. Variant made from PMMA.

### TECHNICAL SPECIFICATIONS:

Dimensions	285.0 x 40.0 mm
Height	9.5 mm
Fastening	clips
ROHS compliant	yes ⓘ

### MATERIAL SPECIFICATIONS:

Component	Type	Material	Colour	Finish
LINNEA-60-B-PMMA	Linear lens	PMMA	clear	

### ORDERING INFORMATION:

Component	Qty in box	MOQ	MPQ	Box weight (kg)
F16814_LINNEA-60-B-PMMA » Box size: 398 x 298 x 265 mm	153	36	36	7.5



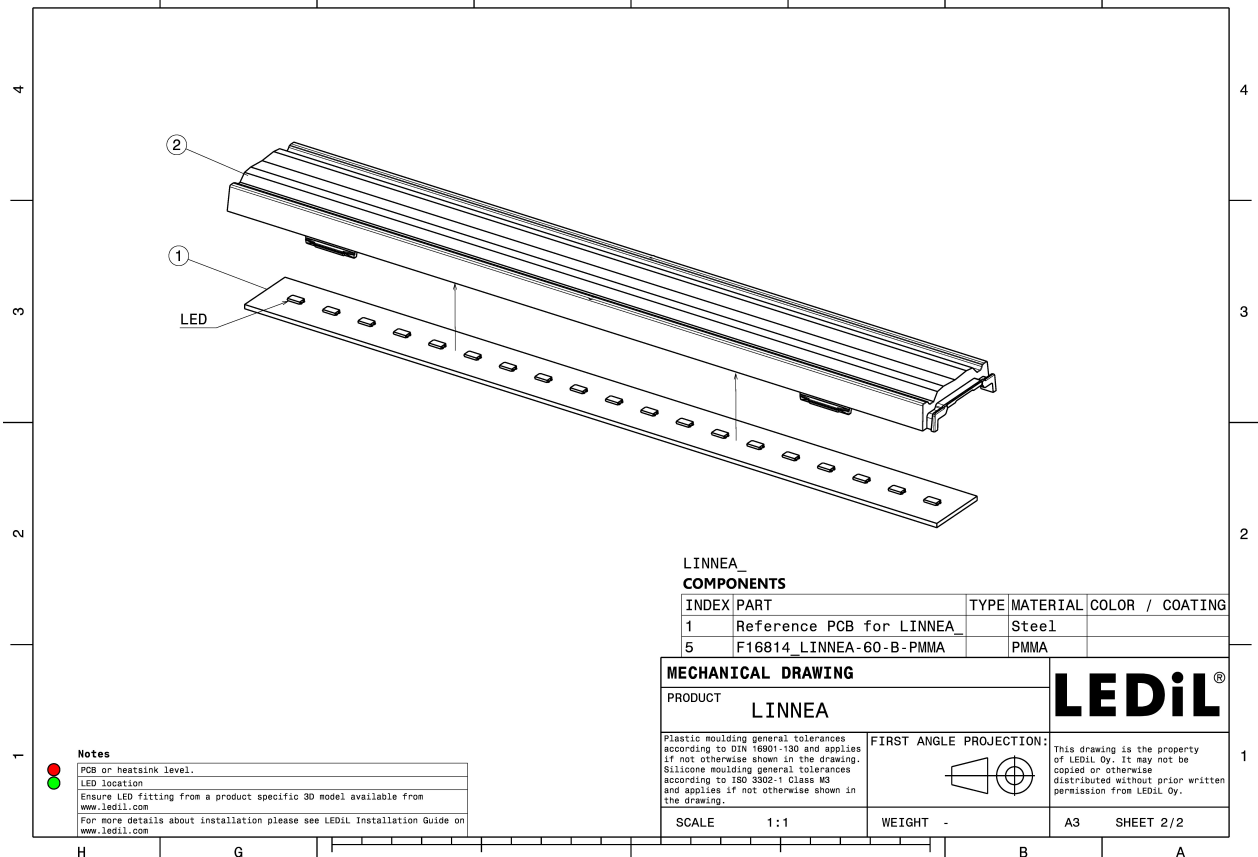
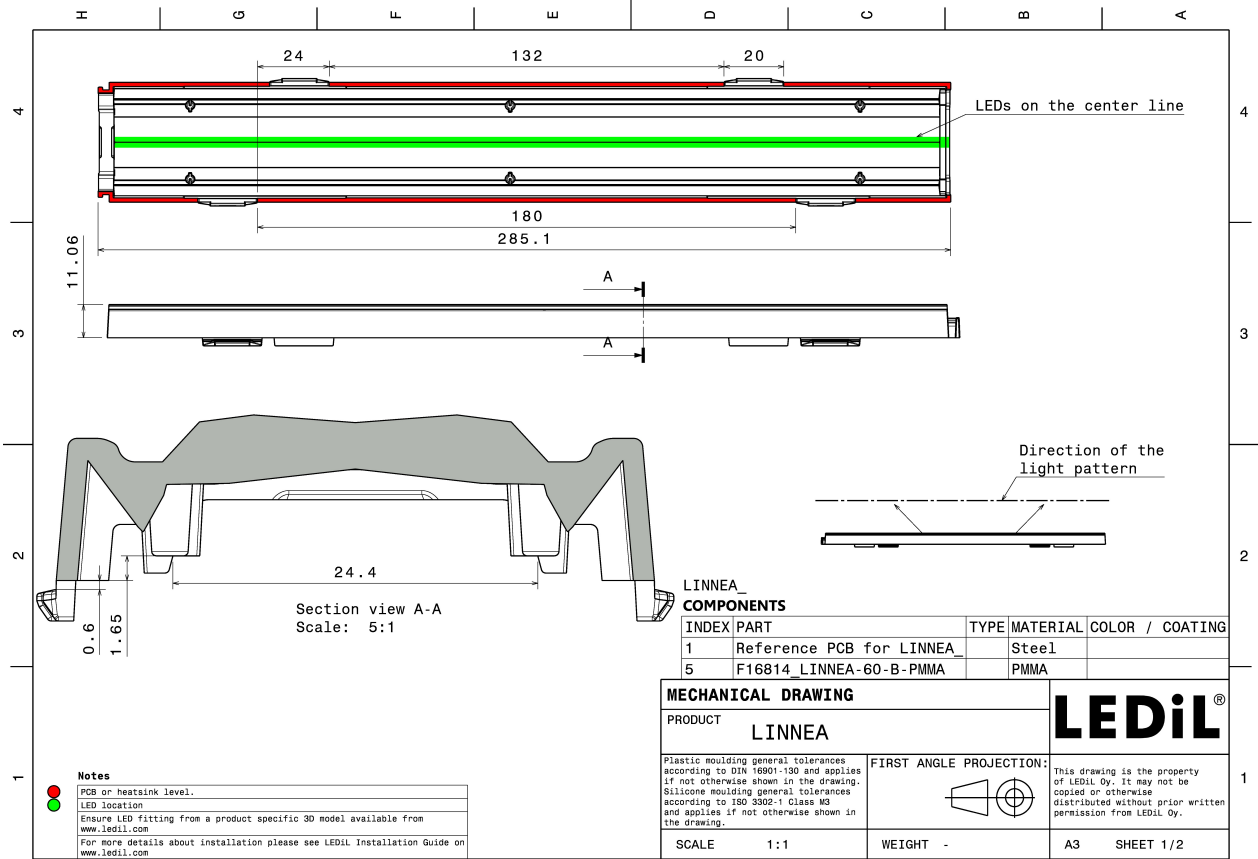

See also our general installation guide: [www.ledil.com/installation\\_guide](http://www.ledil.com/installation_guide)

#### PHOTOMETRIC DATA (MEASURED):

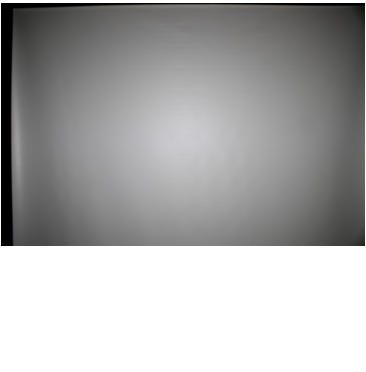
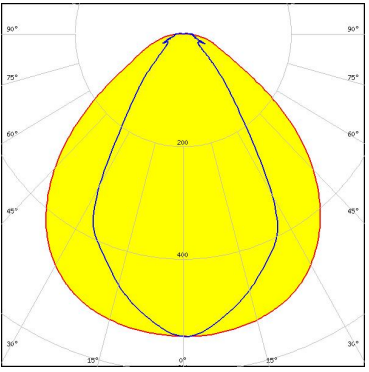
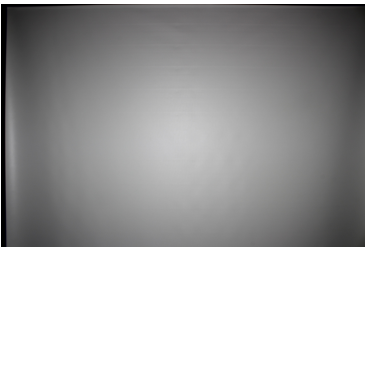
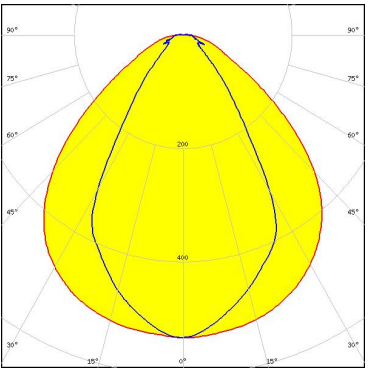
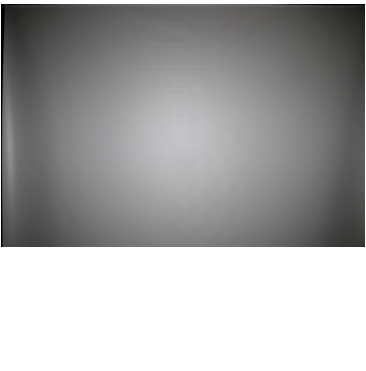
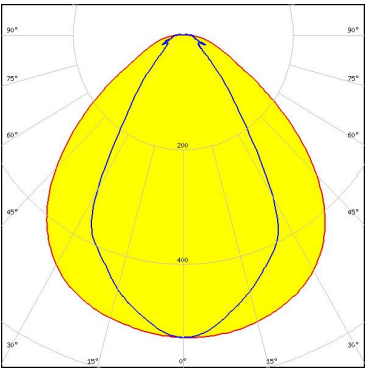
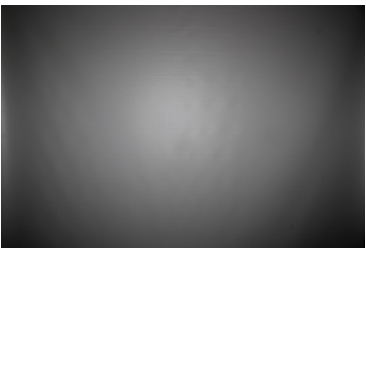
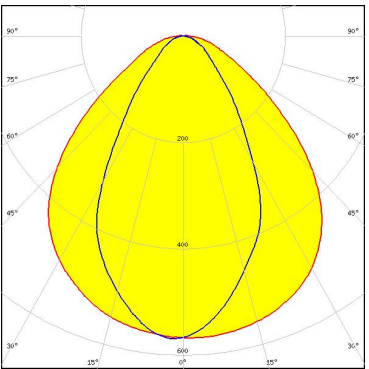
<p><b>Helvar</b></p> <p>LED LP-282-840-009A 60/300</p> <p>FWHM / FWTM 101.0 + 64.0° / 150.0 + 101.0°</p> <p>Efficiency 90 %</p> <p>Peak intensity 0.5 cd/lm</p> <p>LEDs/each optic 1</p> <p>Light colour White</p> <p>Required components:</p>		
<p><b>Helvar</b></p> <p>LED LS-282-840-011A</p> <p>FWHM / FWTM 101.0 + 64.0° / 150.0 + 101.0°</p> <p>Efficiency 90 %</p> <p>Peak intensity 0.5 cd/lm</p> <p>LEDs/each optic 1</p> <p>Light colour White</p> <p>Required components:</p>		
<p><b>Helvar</b></p> <p>LED LX-282-840-023A</p> <p>FWHM / FWTM 100.0 + 65.0° / 150.0 + 102.0°</p> <p>Efficiency 90 %</p> <p>Peak intensity 0.5 cd/lm</p> <p>LEDs/each optic 1</p> <p>Light colour White</p> <p>Required components:</p>		
<p><b>NICHIA</b></p> <p>LED NF2x757G</p> <p>FWHM / FWTM 100.0 + 61.0° / 151.0 + 110.0°</p> <p>Efficiency 92 %</p> <p>Peak intensity 0.6 cd/lm</p> <p>LEDs/each optic 1</p> <p>Light colour White</p> <p>Required components:</p>		

#### PHOTOMETRIC DATA (MEASURED):



**LED** NFSW757H  
**FWHM / FWTM** 100.0 + 60.0° / 147.0 + 99.0°  
**Efficiency** 91 %  
**Peak intensity** 0.6 cd/lm  
**LEDs/each optic** 1  
**Light colour** White  
**Required components:**

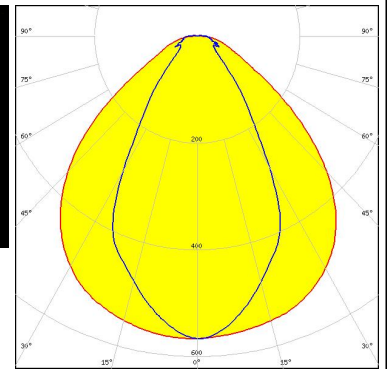

#### OSRAM

**LED** PL-LIN-IND-Z1 2800 560x24  
**FWHM / FWTM** 101.0 + 66.0° / 152.0 + 109.0°  
**Efficiency** 94 %  
**Peak intensity** 0.5 cd/lm  
**LEDs/each optic** 1  
**Light colour** White  
**Required components:**

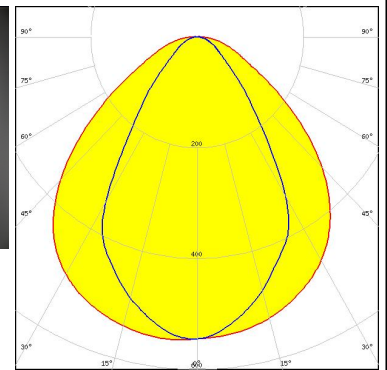

#### OSRAM

**LED** PL-LIN-Z5 1100 280x20  
**FWHM / FWTM** 101.0 + 64.0° / 150.0 + 100.0°  
**Efficiency** 89 %  
**Peak intensity** 0.5 cd/lm  
**LEDs/each optic** 1  
**Light colour** White  
**Required components:**

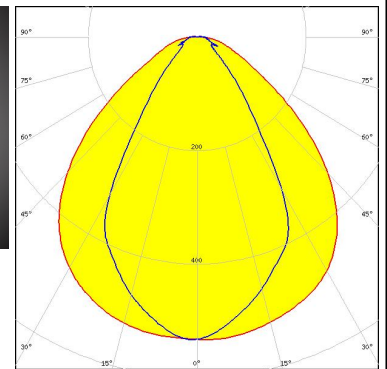
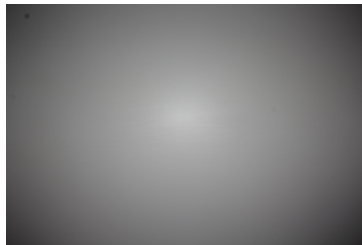

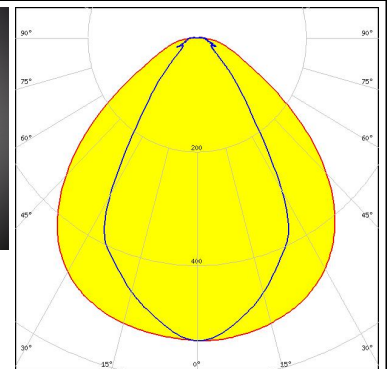

#### OSRAM

**LED** PL-LIN-Z5 2000 280x20  
**FWHM / FWTM** 101.0 + 64.0° / 151.0 + 101.0°  
**Efficiency** 90 %  
**Peak intensity** 0.5 cd/lm  
**LEDs/each optic** 1  
**Light colour** White  
**Required components:**

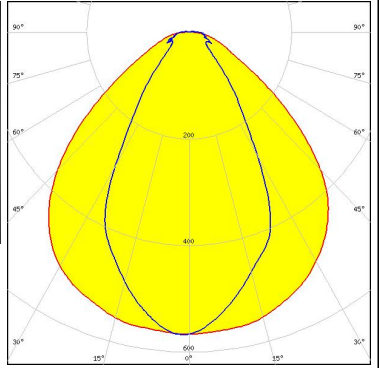

#### PHOTOMETRIC DATA (MEASURED):

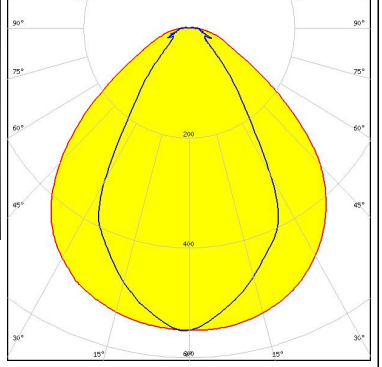
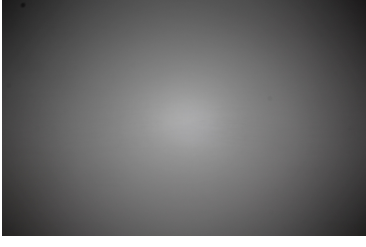
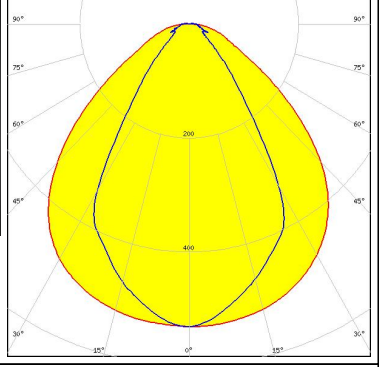
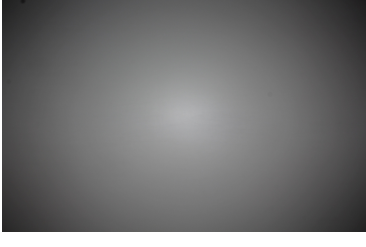
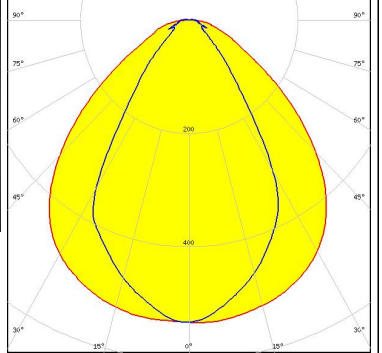
<p><b>OSRAM</b> Opto Semiconductors</p> <p>LED Duris E 2835</p> <p>FWHM / FWTM 100.0 + 60.0° / 147.0 + 98.0°</p> <p>Efficiency 91 %</p> <p>Peak intensity 0.6 cd/lm</p> <p>LEDs/each optic 1</p> <p>Light colour White</p> <p>Required components:</p>		
<p><b>OSRAM</b> Opto Semiconductors</p> <p>LED Duris S5 (Single chip)</p> <p>FWHM / FWTM 101.0 + 64.0° / 150.0 + 101.0°</p> <p>Efficiency 92 %</p> <p>Peak intensity 0.6 cd/lm</p> <p>LEDs/each optic 1</p> <p>Light colour White</p> <p>Required components:</p>		
<p><b>PHILIPS</b></p> <p>LED Fortimo LED Strip 1ft 1100lm FC HV4 &amp; LV4</p> <p>FWHM / FWTM 101.0 + 65.0° / 151.0 + 101.0°</p> <p>Efficiency 91 %</p> <p>Peak intensity 0.5 cd/lm</p> <p>LEDs/each optic 1</p> <p>Light colour White</p> <p>Required components:</p>		
<p><b>PHILIPS</b></p> <p>LED Fortimo LED Strip 1ft 650lm FC HV4 &amp; LV4</p> <p>FWHM / FWTM 100.0 + 65.0° / 151.0 + 101.0°</p> <p>Efficiency 90 %</p> <p>Peak intensity 0.5 cd/lm</p> <p>LEDs/each optic 1</p> <p>Light colour White</p> <p>Required components:</p>		

#### PHOTOMETRIC DATA (MEASURED):

### SAMSUNG

LED LM28xB Series  
 FWHM / FWTM 101.0 + 60.0° / 148.0 + 98.0°  
 Efficiency 91 %  
 Peak intensity 0.6 cd/lm  
 LEDs/each optic 1  
 Light colour White  
 Required components:

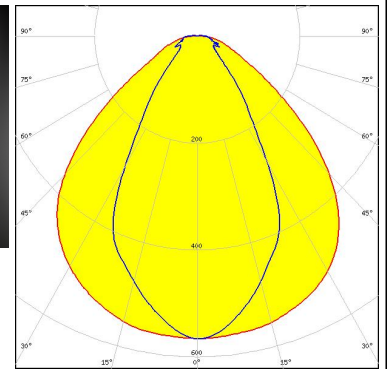

### SAMSUNG

LED LM301B  
 FWHM / FWTM 101.0 + 65.0° / 151.0 + 102.0°  
 Efficiency 92 %  
 Peak intensity 0.5 cd/lm  
 LEDs/each optic 1  
 Light colour White  
 Required components:

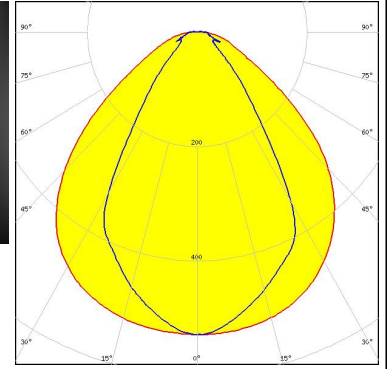

### SAMSUNG

LED LM561B Plus  
 FWHM / FWTM 102.0 + 65.0° / 151.0 + 93.0°  
 Efficiency 91 %  
 Peak intensity 0.5 cd/lm  
 LEDs/each optic 1  
 Light colour White  
 Required components:

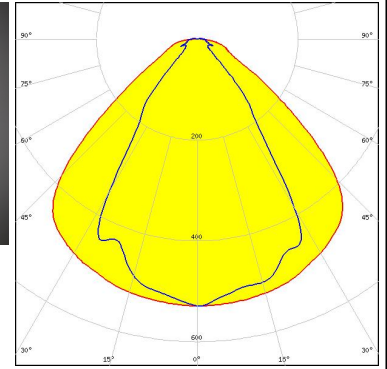

### SAMSUNG

LED LT-H282C  
 FWHM / FWTM 101.0 + 61.0° / 149.0 + 99.0°  
 Efficiency 91 %  
 Peak intensity 0.6 cd/lm  
 LEDs/each optic 1  
 Light colour White  
 Required components:

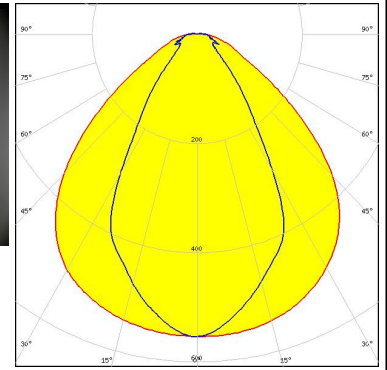

#### PHOTOMETRIC DATA (MEASURED):

### SAMSUNG

LED LT-Q282B  
 FWHM / FWTM 101.0 + 61.0° / 149.0 + 99.0°  
 Efficiency 91 %  
 Peak intensity 0.6 cd/lm  
 LEDs/each optic 1  
 Light colour White  
 Required components:

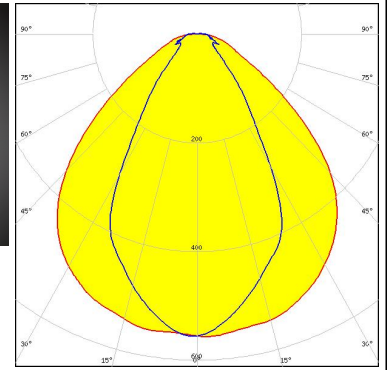

### SAMSUNG

LED LT-V282E  
 FWHM / FWTM 101.0 + 61.0° / 149.0 + 99.0°  
 Efficiency 91 %  
 Peak intensity 0.6 cd/lm  
 LEDs/each optic 1  
 Light colour White  
 Required components:

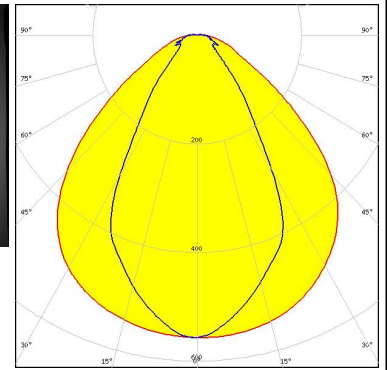

### TRIDONIC

LED LLE 24x280mm 1250lm HV ADV5  
 FWHM / FWTM 101.0 + 65.0° / 151.0 + 101.0°  
 Efficiency 90 %  
 Peak intensity 0.5 cd/lm  
 LEDs/each optic 1  
 Light colour White  
 Required components:

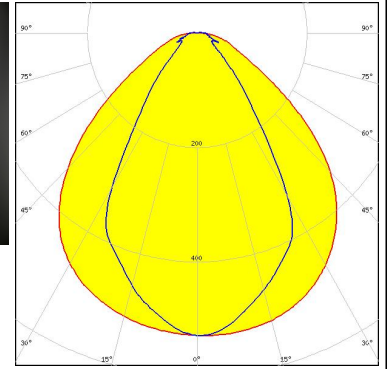

### TRIDONIC

LED LLE 24x280mm 650lm HV ADV5  
 FWHM / FWTM 100.0 + 65.0° / 150.0 + 101.0°  
 Efficiency 90 %  
 Peak intensity 0.5 cd/lm  
 LEDs/each optic 1  
 Light colour White  
 Required components:

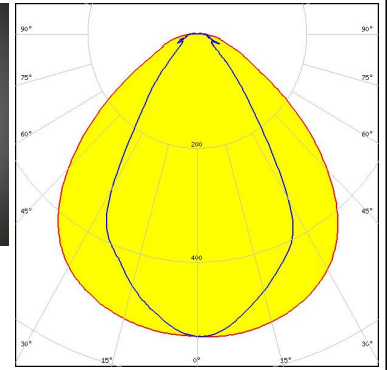
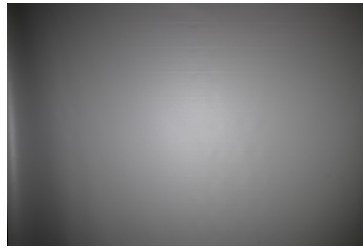

#### GENERAL INFORMATION:

NOTE: The typical beam angle will be changed by different color, chip size and chip position tolerance. The typical total beam angle is the full angle measured where the luminous intensity is half of the peak value.

#### MATERIALS:

As part of our continuous research and improvement processes, and to ensure the best possible quality and availability of our products, LEDiL reserves the right to change material grades without notice.

#### PRODUCT DATA USER AGREEMENT AND DISCLAIMER:

The measured data in the provided downloadable LEDiL Product Datasheets and Mechanical 2D-Drawings is rounded and provided as reference for planning. LEDiL Oy's optical specifications have been verified by conducting performance testing of the products in accordance with the company's quality system. The reported data are averaged results of multiple measurements with typical variation. LEDiL Oy reserves the right to without prior notification make changes and improvements to its products.

LEDiL Oy assumes neither warranty, nor guarantee nor any other liability of any kind for the contents and correctness of the provided data. The provided data has been generated with highest diligence but the provided data may in reality not represent the complete possible variation range of all intrinsic parameters. Therefore, in certain cases a deviation from the provided data could occur.

LEDiL Oy reserves the right to undertake technical changes of its products without further notification which could lead to changes in the provided data. LEDiL Oy assumes no liability of any kind for the possible deviation from any provided data or any other damage resulting from the usage of the provided data.

The user agrees to this disclaimer and user agreement with the download or usage of the provided files.

#### LEDiL Oy

Joensuunkatu 13  
FI-24240 SALO  
Finland

#### LEDiL Inc.

228 West Page Street  
Suite D  
Sycamore IL 60178  
USA

#### Ledil Optics Technology (Shenzhen) Co., Ltd.

# 405 , Block B  
Casic Motor Building  
Shenzhen 518057  
P.R.CHINA

#### Local sales and technical support

[www.ledil.com/  
where\\_to\\_buy](http://www.ledil.com/where_to_buy)

#### Shipping locations

Salo, Finland  
Hong Kong, China

#### Distribution Partners

[www.ledil.com/  
where\\_to\\_buy](http://www.ledil.com/where_to_buy)