

## LISA2-RS-PIN

~19° spot beam optimized for LUXEON Rebel.  
6.6 mm high variant with location pin installation.

### SPECIFICATION:

|                |           |
|----------------|-----------|
| Dimensions     | Ø 9.9     |
| Height         | 6.6 mm    |
| Fastening      | glue, pin |
| ROHS compliant | yes ⓘ     |



### MATERIALS:

| Component        | Type        | Material | Colour | Finish | Length (mm) |
|------------------|-------------|----------|--------|--------|-------------|
| LISA2-RS         | Single lens | PMMA     | clear  |        |             |
| LISA2-HLD-PIN-RE | Holder      | PC       | black  |        |             |

### ORDERING INFORMATION:

| Component            |             | Qty in box | MOQ | MPQ | Box weight (kg) |
|----------------------|-------------|------------|-----|-----|-----------------|
| FP11056_LISA2-RS-PIN | Single lens | 2000       | 300 | 100 | 1.4             |
| » Box size:          |             |            |     |     |                 |

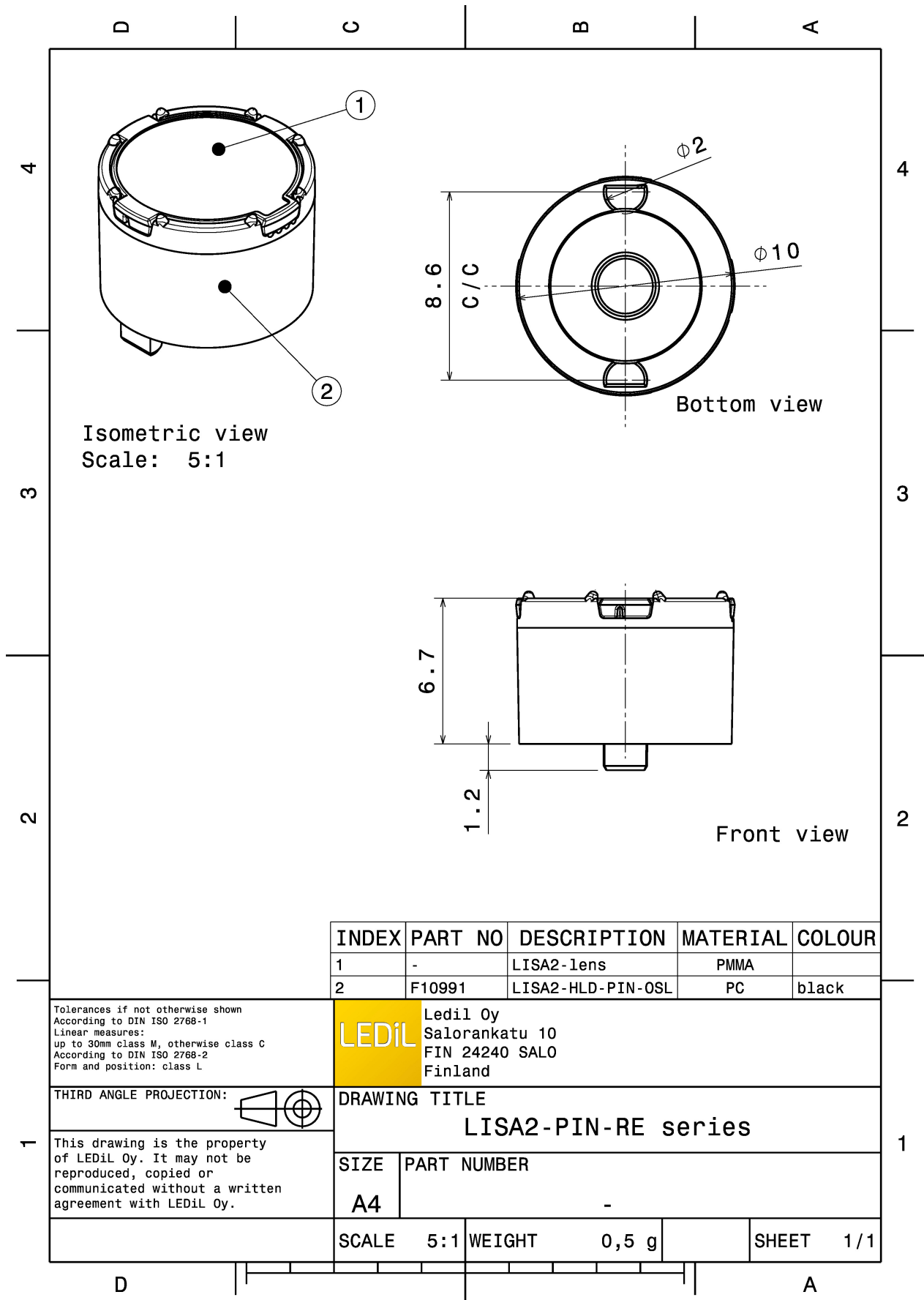

See also our general installation guide: [www.ledil.com/installation\\_guide](http://www.ledil.com/installation_guide)

### OPTICAL RESULTS (MEASURED):

#### LUMILEDS

LED LUXEON A  
FWHM / FWTM 23.0° / 48.0°  
Efficiency 91 %  
Peak intensity 3.1 cd/lm  
LEDs/each optic 1  
Light colour/type White  
Required components:



[Light distribution files](#)

#### LUMILEDS

LED LUXEON Rebel  
FWHM / FWTM 18.0°  
Efficiency 91 %  
LEDs/each optic 1  
Light colour/type White  
Required components:

[Light distribution files](#)

#### LUMILEDS

LED LUXEON Rebel ES  
FWHM / FWTM 24.0° / 50.0°  
Efficiency 91 %  
Peak intensity 3.6 cd/lm  
LEDs/each optic 1  
Light colour/type White  
Required components:

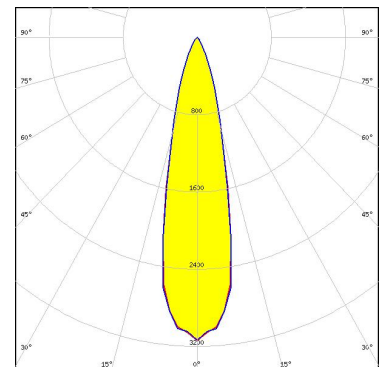

[Light distribution files](#)

### OPTICAL RESULTS (MEASURED):

#### SAMSUNG

LED LH181B  
FWHM / FWTM 18.0° / 50.0°  
Efficiency 80 %  
Peak intensity 3.5 cd/lm  
LEDs/each optic 1  
Light colour/type White  
Required components:

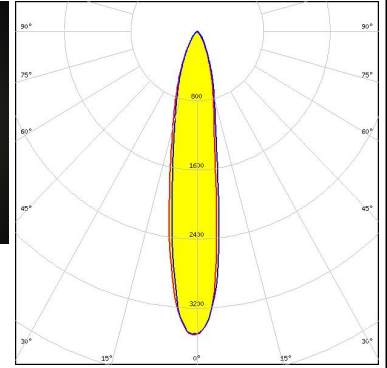

Light distribution files

### OPTICAL RESULTS (SIMULATED):



LED XD16  
FWHM / FWTM 20.0° / 38.0°  
Efficiency 85 %  
Peak intensity 5.2 cd/lm  
LEDs/each optic 1  
Light colour/type White  
Required components:

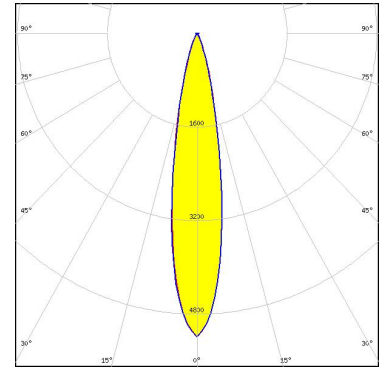

Light distribution files



LED LUXEON Rebel  
FWHM / FWTM 18.0° / 34.0°  
Efficiency 92 %  
Peak intensity 7.3 cd/lm  
LEDs/each optic 1  
Light colour/type White  
Required components:

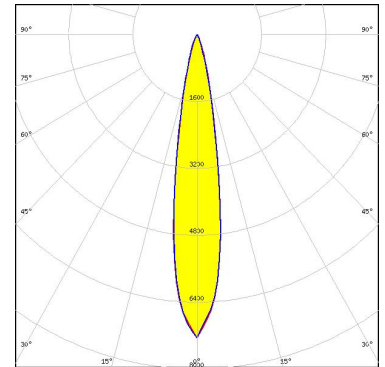

Light distribution files



LED NCSWE13A  
FWHM / FWTM 12.0° / 30.0°  
Efficiency 82 %  
Peak intensity 9.4 cd/lm  
LEDs/each optic 1  
Light colour/type White  
Required components:

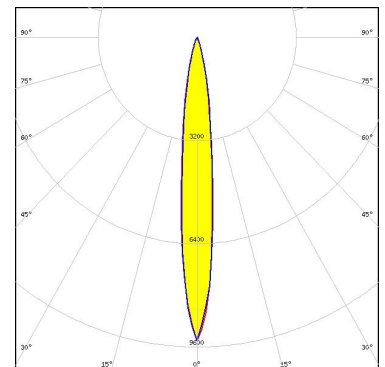

Light distribution files

#### OPTICAL RESULTS (SIMULATED):

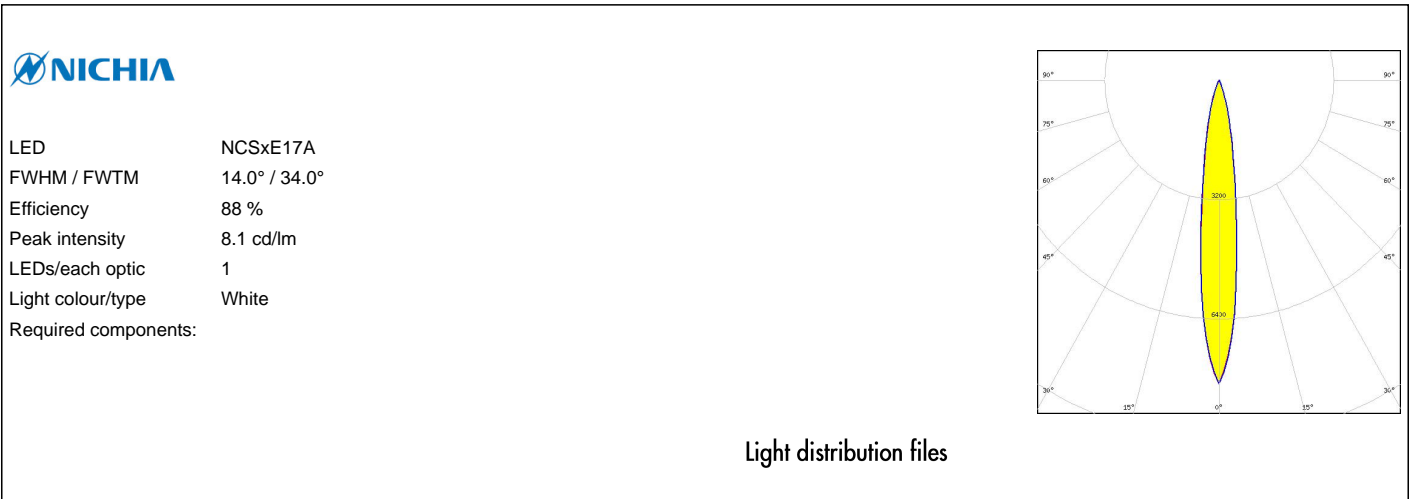

#### GENERAL INFORMATION:

NOTE: The typical beam angle will be changed by different color, chip size and chip position tolerance. The typical total beam angle is the full angle measured where the luminous intensity is half of the peak value.

#### MATERIALS:

As part of our continuous research and improvement processes, and to ensure the best possible quality and availability of our products, LEDiL reserves the right to change material grades without notice.

#### PRODUCT DATA USER AGREEMENT AND DISCLAIMER:

The measured data in the provided downloadable LEDiL Product Datasheets and Mechanical 2D-Drawings is rounded and provided as reference for planning. LEDiL Oy's optical specifications have been verified by conducting performance testing of the products in accordance with the company's quality system. The reported data are averaged results of multiple measurements with typical variation. LEDiL Oy reserves the right to without prior notification make changes and improvements to its products.

LEDiL Oy assumes neither warranty, nor guarantee nor any other liability of any kind for the contents and correctness of the provided data. The provided data has been generated with highest diligence but the provided data may in reality not represent the complete possible variation range of all intrinsic parameters. Therefore, in certain cases a deviation from the provided data could occur.

LEDiL Oy reserves the right to undertake technical changes of its products without further notification which could lead to changes in the provided data. LEDiL Oy assumes no liability of any kind for the possible deviation from any provided data or any other damage resulting from the usage of the provided data.

The user agrees to this disclaimer and user agreement with the download or usage of the provided files.

#### LEDiL Oy

Joensuunkatu 7  
FI-24240 SALO  
Finland

#### LEDiL Inc.

228 West Page Street  
Suite D  
Sycamore IL 60178  
USA

#### Ledil Optics Technology (Shenzhen) Co., Ltd.

# 405 , Block B  
Casic Motor Building  
Shenzhen 518057  
P.R.CHINA

#### Local sales and technical support

[www.ledil.com/  
where\\_to\\_buy](http://www.ledil.com/where_to_buy)

#### Shipping locations

Poznan, Poland  
Hong Kong, China

#### Distribution Partners

[www.ledil.com/  
where\\_to\\_buy](http://www.ledil.com/where_to_buy)