

LISA4-WW

~45° spot beam with integrated pins on lens

SPECIFICATION:

Dimensions	Ø 10.0 mm
Height	7.7 mm
Fastening	pin
ROHS compliant	yes ⓘ

MATERIALS:

Component	Type	Material	Colour	Finish
LISA4-WW	Single lens	PMMA	clear	

ORDERING INFORMATION:

Component	Qty in box	MOQ	MPQ	Box weight (kg)
C17524_LISA4-WW » Box size: 430 x 390 x 215 mm	20000	1000	1000	7.5



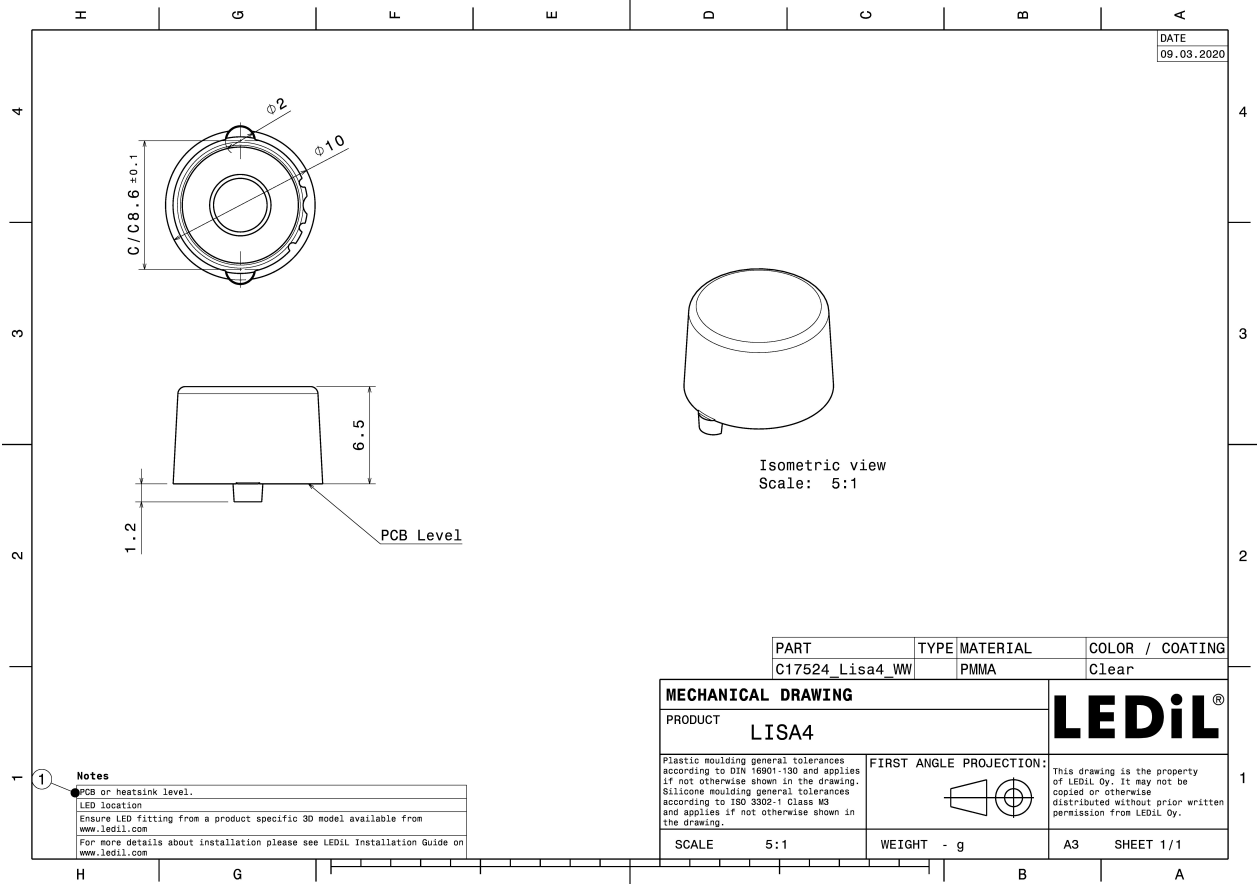

See also our general installation guide: www.ledil.com/installation_guide

OPTICAL RESULTS (SIMULATED):



LED XP-E2
 FWHM / FWTM 45.0° / 70.0°
 Efficiency 95 %
 Peak intensity 1.5 cd/lm
 LEDs/each optic 1
 Light colour White
 Required components:

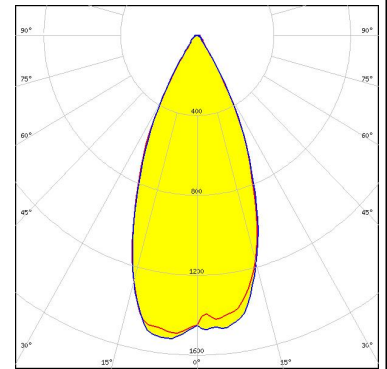

LED XP-G2
 FWHM / FWTM 47.0° / 74.0°
 Efficiency 95 %
 Peak intensity 1.4 cd/lm
 LEDs/each optic 1
 Light colour White
 Required components:

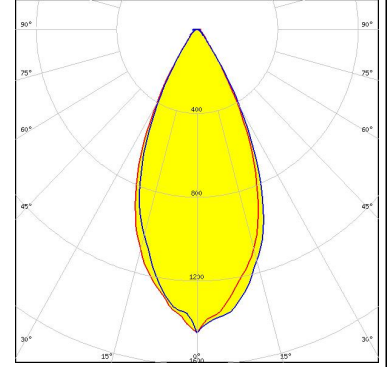

LED XP-G3
 FWHM / FWTM 52.0° / 84.0°
 Efficiency 94 %
 Peak intensity 1.1 cd/lm
 LEDs/each optic 1
 Light colour White
 Required components:

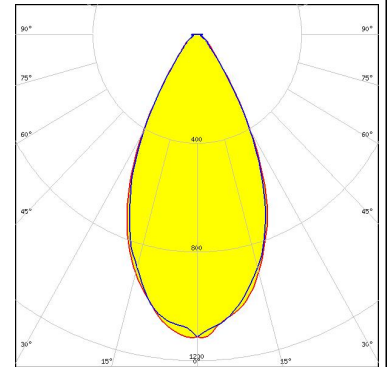

LED LUXEON HL1Z
 FWHM / FWTM 30.0° / 56.0 + 55.0°
 Efficiency 97 %
 Peak intensity 2.6 cd/lm
 LEDs/each optic 1
 Light colour White
 Required components:

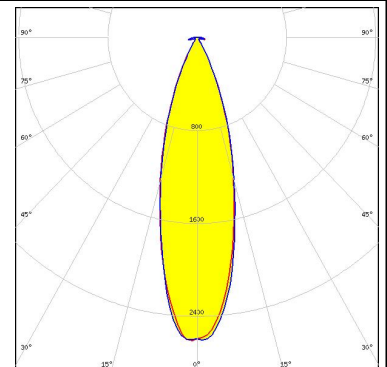

OPTICAL RESULTS (SIMULATED):

LUMILEDS

LED LUXEON Rubix
 FWHM / FWTM 47.0° / 70.0°
 Efficiency 95 %
 Peak intensity 1.5 cd/lm
 LEDs/each optic 1
 Light colour White
 Required components:

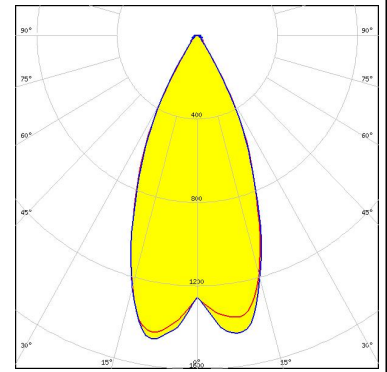

LUMILEDS

LED LUXEON TX
 FWHM / FWTM 46.0° / 73.0°
 Efficiency 95 %
 Peak intensity 1.4 cd/lm
 LEDs/each optic 1
 Light colour White
 Required components:

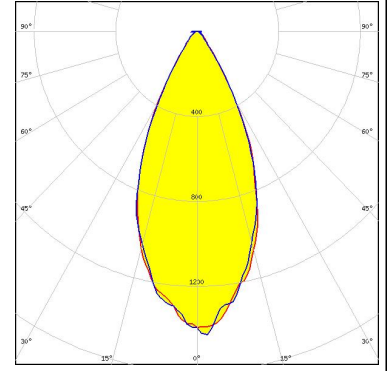

LUMINUS

LED SST-10-IR-B90
 FWHM / FWTM 36.0° / 64.0°
 Efficiency 93 %
 LEDs/each optic 1
 Light colour IR
 Required components:

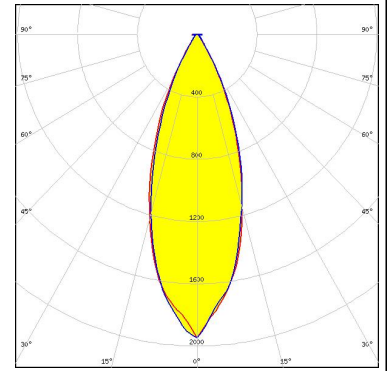
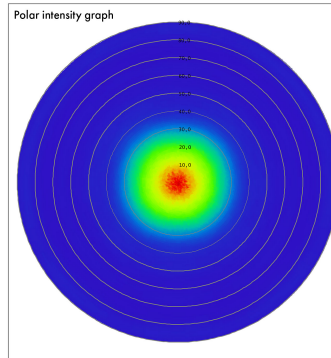

NICHIA

LED NCSxE17A
 FWHM / FWTM 30.0° / 56.0°
 Efficiency 95 %
 Peak intensity 2.4 cd/lm
 LEDs/each optic 1
 Light colour White
 Required components:

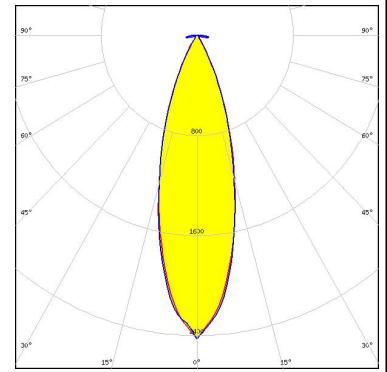

OPTICAL RESULTS (SIMULATED):

<p>NICHIA</p> <p>LED: NVSW219F FWHM / FWTM: 53.0° / 80.0° Efficiency: 95 % Peak intensity: 1.2 cd/lm LEDs/each optic: 1 Light colour: White Required components:</p>	
<p>OSRAM Opto Semiconductors</p> <p>LED: Duris S5 (2 chip) FWHM / FWTM: 39.0° / 66.0° Efficiency: 95 % Peak intensity: 1.8 cd/lm LEDs/each optic: 1 Light colour: White Required components:</p>	
<p>OSRAM Opto Semiconductors</p> <p>LED: Duris S5 (Single chip) FWHM / FWTM: 36.0° / 64.0° Efficiency: 95 % Peak intensity: 2.1 cd/lm LEDs/each optic: 1 Light colour: White Required components:</p>	
<p>OSRAM Opto Semiconductors</p> <p>LED: OSCONIQ C 2424 FWHM / FWTM: 37.0° / 64.0° Efficiency: 96 % Peak intensity: 2.1 cd/lm LEDs/each optic: 1 Light colour: White Required components:</p>	

OPTICAL RESULTS (SIMULATED):

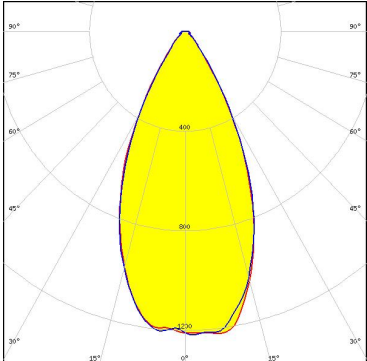
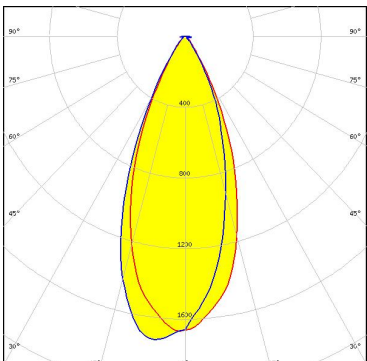
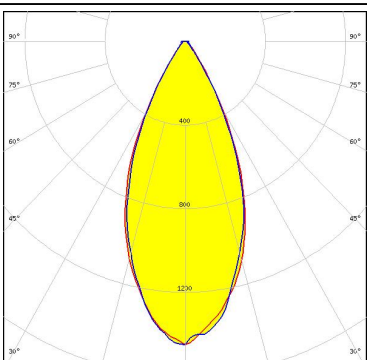
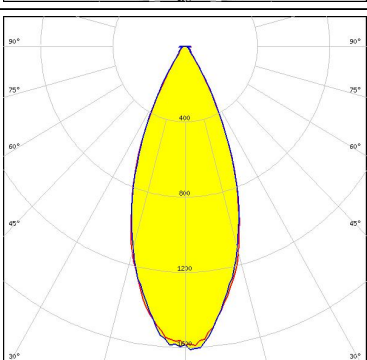
<p>OSRAM Opto Semiconductors</p> <p>LED OSCONIQ P 3737 (3W version)</p> <p>FWHM / FWTM 50.0° / 78.0°</p> <p>Efficiency 96 %</p> <p>Peak intensity 1.2 cd/lm</p> <p>LEDs/each optic 1</p> <p>Light colour White</p> <p>Required components:</p>	
<p>OSRAM Opto Semiconductors</p> <p>LED OSCONIQ S 3030 (QSLR31)</p> <p>FWHM / FWTM 41.0° / 68.0°</p> <p>Efficiency 95 %</p> <p>Peak intensity 1.7 cd/lm</p> <p>LEDs/each optic 1</p> <p>Light colour White</p> <p>Required components:</p>	
<p>OSRAM Opto Semiconductors</p> <p>LED OSLON Square CSSRM2/CSSRM3</p> <p>FWHM / FWTM 46.0° / 73.0°</p> <p>Efficiency 95 %</p> <p>Peak intensity 1.4 cd/lm</p> <p>LEDs/each optic 1</p> <p>Light colour White</p> <p>Required components:</p>	
<p>OSRAM Opto Semiconductors</p> <p>LED OSLON Square EC</p> <p>FWHM / FWTM 42.0° / 68.0°</p> <p>Efficiency 95 %</p> <p>Peak intensity 1.5 cd/lm</p> <p>LEDs/each optic 1</p> <p>Light colour White</p> <p>Required components:</p>	

OPTICAL RESULTS (SIMULATED):

OSRAM

Opto Semiconductors

LED OSLO[®] SSL 80
FWHM / FWTM 32.0° / 63.0°
Efficiency 95 %
Peak intensity 2.2 cd/lm
LEDs/each optic 1
Light colour White
Required components:

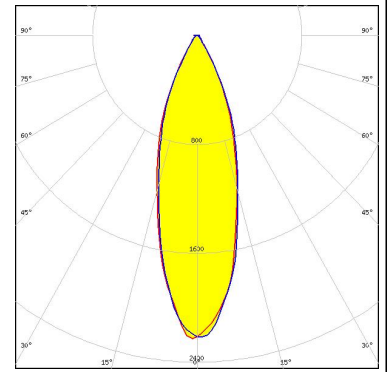

SAMSUNG

LED LH351B
FWHM / FWTM 47.0° / 76.0°
Efficiency 95 %
Peak intensity 1.4 cd/lm
LEDs/each optic 1
Light colour White
Required components:

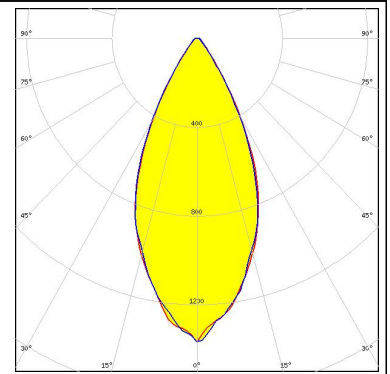

GENERAL INFORMATION:

NOTE: The typical beam angle will be changed by different color, chip size and chip position tolerance. The typical total beam angle is the full angle measured where the luminous intensity is half of the peak value.

MATERIALS:

As part of our continuous research and improvement processes, and to ensure the best possible quality and availability of our products, LEDiL reserves the right to change material grades without notice.

PRODUCT DATA USER AGREEMENT AND DISCLAIMER:

The measured data in the provided downloadable LEDiL Product Datasheets and Mechanical 2D-Drawings is rounded and provided as reference for planning. LEDiL Oy's optical specifications have been verified by conducting performance testing of the products in accordance with the company's quality system. The reported data are averaged results of multiple measurements with typical variation. LEDiL Oy reserves the right to without prior notification make changes and improvements to its products.

LEDiL Oy assumes neither warranty, nor guarantee nor any other liability of any kind for the contents and correctness of the provided data. The provided data has been generated with highest diligence but the provided data may in reality not represent the complete possible variation range of all intrinsic parameters. Therefore, in certain cases a deviation from the provided data could occur.

LEDiL Oy reserves the right to undertake technical changes of its products without further notification which could lead to changes in the provided data. LEDiL Oy assumes no liability of any kind for the possible deviation from any provided data or any other damage resulting from the usage of the provided data.

The user agrees to this disclaimer and user agreement with the download or usage of the provided files.

LEDiL Oy

Joensuunkatu 13
FI-24240 SALO
Finland

LEDiL Inc.

228 West Page Street
Suite D
Sycamore IL 60178
USA

Ledil Optics Technology (Shenzhen) Co., Ltd.

405 , Block B
Casic Motor Building
Shenzhen 518057
P.R.CHINA

Local sales and technical support

[www.ledil.com/
where_to_buy](http://www.ledil.com/where_to_buy)

Shipping locations

Salo, Finland
Hong Kong, China

Distribution Partners

[www.ledil.com/
where_to_buy](http://www.ledil.com/where_to_buy)